

93-11

CRREL REPORT



# Gas Gun Experiments to Determine Shock Wave Behavior in Snow

## Methods and Data

Jerome B. Johnson, Joseph A. Brown, Edward S. Gaffney,  
Daniel J. Solie, Matthew A. Sturm and George L. Blaisdell

July 1993

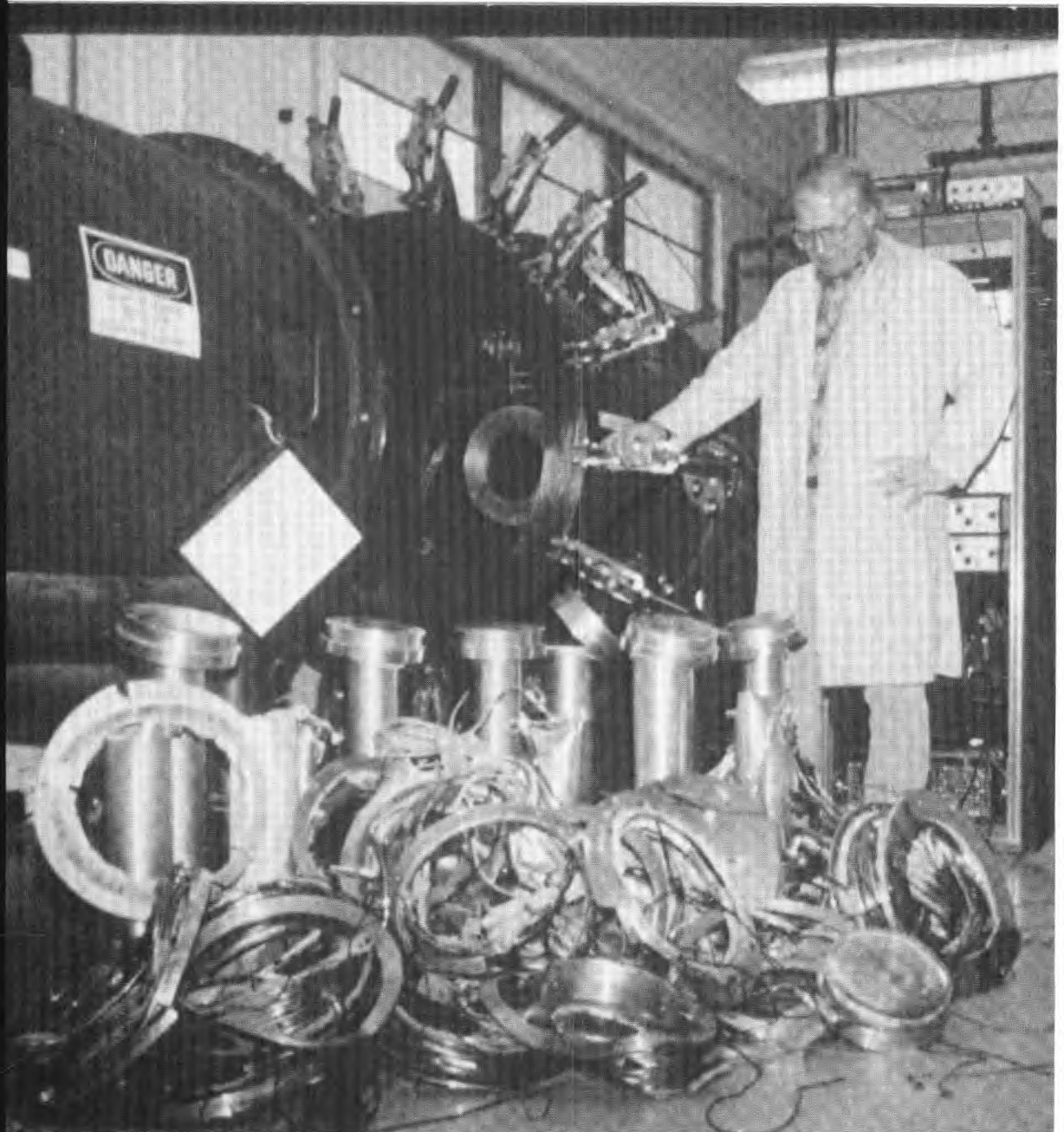

**Abstract**

A laboratory study of the behavior of snow under shock wave loading and unloading conditions was conducted using a 200-mm-diameter gas gun to generate loading waves in snow samples with initial densities of 100 to 520 kg m<sup>-3</sup> at temperatures of -2 to -23°C. Stress levels were 2 to 40 MPa. The response of snow to shock wave loading was measured as a function of distance from the impact plane using embedded stress gauges. Large impedance differences between snow and the stress gauges produced complex stress histories. A finite element model, along with a simple analytical model of the experiment, was used to interpret the stress histories. Snow deformation was not affected by initial temperature, but was found to be rate dependent. The initial density of the snow determined its pressure-deformation path. The pressure needed to compact snow to a specific final density increases with decreasing initial density. The release moduli increased nonlinearly from 50 MPa at a snow pressure of about 15 MPa to 2700 MPa at a snow pressure of about 40 MPa.

*Cover: Gas gun setup.*

For conversion of SI metric units to U.S./British customary units of measurement consult ASTM Standard E380-89a, *Standard Practice for Use of the International System of Units*, published by the American Society for Testing and Materials, 1916 Race St., Philadelphia, Pa. 19103.

CRREL Report 93-11



**US Army Corps  
of Engineers**

Cold Regions Research &  
Engineering Laboratory

# **Gas Gun Experiments to Determine Shock Wave Behavior in Snow**

## **Methods and Data**

Jerome B. Johnson, Joseph A. Brown, Edward S. Gaffney,  
Daniel J. Solie, Matthew A. Sturm and George L. Blaisdell

July 1993

Prepared for  
OFFICE OF THE CHIEF OF ENGINEERS

Approved for public release; distribution is unlimited.

## PREFACE

This report was prepared by Dr. Jerome B. Johnson, Geophysicist, Dr. Daniel J. Solie, Research Physical Scientist, Dr. Matthew A. Sturm, Research Physical Scientist, George L. Blaisdell, Research Civil Engineer, Applied Research Branch, Experimental Engineering Division, U.S. Army Cold Regions Research and Engineering Laboratory; Dr. Joseph A. Brown, Physicist, Earth and Space Sciences Division, Los Alamos National Laboratory, Los Alamos, New Mexico; and Dr. Edward S. Gaffney, Geologist, Ktech Corp., Albuquerque, New Mexico. Funding was provided by DA Project 4A762784AT42, *Cold Regions Engineering Technology*; Work Unit CS/012, *Attenuation of Shock Waves by Snow*.

The authors thank K. Ricks for his assistance in conducting shock experiments, S. A. Barrett for compiling the data plots and tables, and Dr. L. Seaman for his consultation and encouragement during this study. The helpful cooperation of the Earth and Space Sciences Division at Los Alamos during the experimental program is greatly appreciated. Dr. L. Shapiro reviewed this report and provided many helpful comments. The support and encouragement of Dr. R.A. Liston, Dr. L.E. Link and Dr. E. Marvin are also greatly appreciated.

The contents of this report are not to be used for advertising or promotional purposes. Citation of brand names does not constitute an official endorsement or approval of the use of such commercial products.

# Gas Gun Experiments to Determine Shock Wave Behavior in Snow Methods and Data

JEROME B. JOHNSON, JOSEPH A. BROWN, EDWARD S. GAFFNEY,  
DANIEL J. SOLIE, MATTHEW A. STURM, AND GEORGE L. BLAISDELL

## INTRODUCTION

We conducted 28 shock experiments on snow. The results were analyzed to determine the influence of temperature, initial density, snow texture and shock amplitude on shock wave propagation in snow (Table A1).

Shock wave experiments are used to develop stress-strain relations that can be used to computationally model an actual event or to simulate actual conditions by conducting laboratory-scale shock experiments. Experimentally simulating actual conditions can be expensive and time consuming, even if it is possible to replicate the complexities of actual conditions. Computational methods can significantly reduce the time and cost of examining a problem and, when used in combination with experimental simulations, can also result in a better understanding of quite complex processes.

We undertook this shock wave study because understanding the shock response of snow is necessary to solve a number of important problems in cold regions engineering and planetary science. Also, seismic monitoring and shock wave isolation applications require a detailed knowledge of shock wave propagation and attenuation in snow.

Calculating shock wave propagation and attenuation in snow requires a knowledge of snow's compaction response to shock loading and its volume recovery upon unloading. The high porosity of snow and high homologous temperature\* cause highly attenuated, unsteady shock wave propaga-

tion. Thus, with the exception of the high pressure experiments (3.8–35.4 GPa) of Bakanova et al. (1976), efforts to determine the shock wave loading behavior of snow (including this study) have been plagued by difficulties (Napadensky 1964, Wakahama and Sato 1977, Sato and Brown 1983, Sato 1987; and others, see Albert 1983). Problems associated with experimental design and measurement accuracy contribute to experimental uncertainty. Moreover, the difficulties associated with conducting experiments in snow and assumptions used to analyze data have often produced results that could not be unambiguously interpreted.

Some of the difficulties encountered by previous investigators include the following:

1. The loading geometries used in some experiments were complex and produced nonplanar stresses.

2. The methods used to analyze experimental results often assumed steady-state, plane-wave propagation conditions, even though the experiments were neither steady nor planar.

3. The measurements of particle velocity typically contain a large amount of scatter. For example, in Napadensky's analysis the uncertainty in particle velocity measurements is the probable reason that some of the calculated final "shocked" densities for snow exceeded the density of ice, a physically unrealistic result.

4. Pressure measurements have been analyzed without accounting for the impedance difference between the snow sample and pressure transducers attached to it. Such differences can produce significant discrepancies between measured and actual snow pressures.

The difficulties experienced by earlier investigators are understandable given the problems of

---

\* Homologous temperature is the ratio between the actual temperature of a material and its melting temperature in Kelvin.

conducting shock experiments and the unsteady propagation and high attenuation of shock waves in snow.

Factors that make shock wave experiments in snow difficult to design or analyze include the following:

1. The shock wave velocity in snow is low and the difference between the loading and release wave velocities is large, so that the applied uniaxial strain field degrades rapidly.

2. Because of the high homologous temperature of snow, the vapor pressure is high and can result in evaporation when experiments are conducted in the evacuated target chamber of a gas gun. The high homologous temperatures may also result in phase changes during an experiment.

3. The low initial density and large change in density during shock compaction contribute to impedance differences between measurement gauges and the snow. The impedance differences between gauges embedded in snow also may result in premature gauge failure and produce differential motion between the gauges and snow.

4. The heterogeneous granular texture of snow can produce locally high stresses that are not representative of the bulk state of snow and can puncture embedded gauges.

5. Snow is a highly dissipative material, so that large changes in stress and deformation mechanisms that affect the attenuation rate, particle velocity and propagation velocity can occur over a short distance. To avoid "smearing" information between different deformation regimes, gauges embedded in snow must be spaced on the same scale over which the deformation mechanisms act.

Unless the above factors are taken into account when designing shock wave experiments and analyzing the results, the final calculated pressure-density (or volume) information will not accurately represent the shock response of snow. Much of the effort during this study was devoted to attempts to design experiments to reduce the effects of the above factors. We also analyzed our experiments using finite element computer models to determine what factors affected our measured data and used this information to develop methods to interpret the data.

We had initially planned to determine the shock response of snow by using measured stress histories from embedded gauges and Lagrangian analysis to directly calculate stress-strain behavior upon shock loading and unloading. This method was first proposed by Fowles and Williams (1970) and subsequently refined by Cowperthwaite and Wil-

liams (1971), Grady (1973), Seaman (1974) and Cagnoux et al. (1987). Under ideal conditions the method assumes that measured stresses reproduce actual stresses in the snow to a high degree. A necessary condition for this is that the embedded stress gauges\* do not significantly influence the stress or particle velocity flow field of a propagating shock wave. This condition can be met when the impedance of the gauge is similar to that of the snow. Matching the impedance of snow is particularly difficult as the initial density of snow is low compared to materials used in manufacturing stress gauges. In addition, the impedance of snow changes by several orders of magnitude during a shock experiment because of compaction.

An alternate method of obtaining accurate direct measurements in a material, when impedances cannot be matched, is to construct a gauge such that the transit time of a shock wave across the gauge ( $t_g$ ) is much less than the shock rise time ( $t_r$ ). The transit time of the shock wave across the gauge thickness is given by

$$t_g = d_g / C_g$$

where  $C_g$  is the wave propagation speed in the gauge and  $d_g$  is the gauge thickness.

When the impedance and transit time conditions cannot be met, as was the situation for our experiments, then the gauge stress records must be analyzed by modeling the experiment and gauge-snow response (Brown et al. 1988, Gaffney 1989, Johnson et al. 1992a). We used the specific experimental information (for example, the properties of the materials used to construct the experimental apparatus, impact velocity, gauge material and position), a dynamic finite element program, and a simple analytical model to help interpret the measured data. In addition to the impedance mismatch problem, the shock wave stress records were sufficiently long that release waves generated at the edge of the target aluminum buffer propagated to the stress gauges in the snow before the experiment ended (Johnson et al. 1992a). We analyzed the importance of release waves to the experimental

---

\* Stresses cannot be directly measured. Instead, a gauge responds to pressure, the force acting over a known area. The term stress gauge is used in this report since it is common usage in the literature and we are interested in determining the stress state of snow from the gauge measurements. Pressure, in this study, is defined as the mean stress state of the snow.

results with a two-dimensional finite element program (Johnson et al. 1992a).

In the following, we describe the experimental equipment, sample preparation methods and experimental procedure used in this study. We briefly discuss data analysis and results, and suggest methods of improving experimental measurements. The data collected during the experimental program are presented in Appendices A and B. Results are presented in the *Data Analysis* section. However, the complete results and data interpretation methods are presented in Johnson et al. (1990, 1992a,b and 1993).

## EXPERIMENTAL EQUIPMENT AND METHODS

### Gas gun

We used a single-stage gas gun with a 200-mm barrel to generate shock waves in our snow target assemblies (Fig. 1). The gun used compressed nitrogen gas to propel an aluminum projectile that carried a cylindrical impactor: "the flyer" (Fig. 2). The barrel of the gun was smooth, with a slight taper that enforced a planar impact on the target to within a design limit of 0.060 mrad. A target assembly, consisting of snow and stress gauges, was

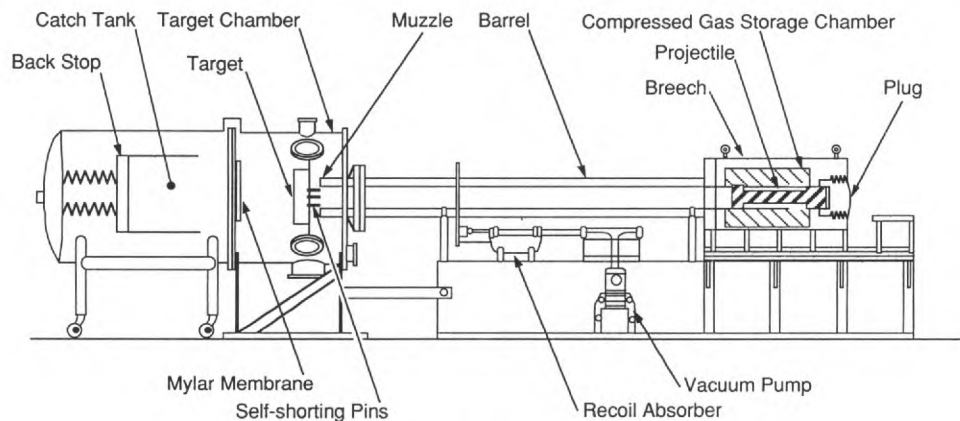
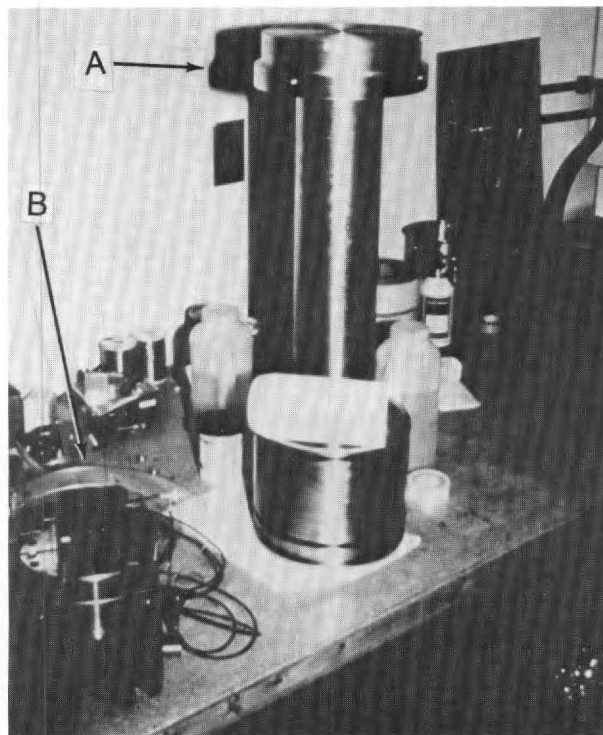
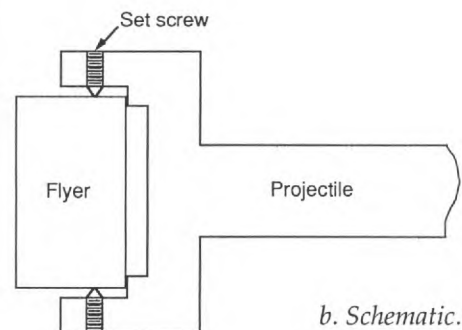

Figure 1. Gas gun assembly.



a. Photo showing projectile (A on the right) and PMMA collar with different length self-shorting pins (B in the vise on the left).



b. Schematic.

Figure 2. Projectile with mounted aluminum flyer plate.



attached to the flat-ground muzzle end of the barrel by break-away nylon bolts. Prior to an experiment, the gas gun was evacuated so that the catch tank barrel assembly, the target chamber and the breech behind the projectile had internal pressures of 200–270, 10–40 and 8 Pa respectively. A mylar diaphragm (Fig. 1)—the remains of which, after an experiment, can be seen in Figure 3—separated the catch tank volume from the target chamber. We fired the gun remotely by retracting a pair of pins that secured the projectile in place, allowing the compressed nitrogen gas to accelerate the projectile down the barrel. After the projectile struck the target, both the target and projectile punctured the mylar diaphragm and decelerated in the rag-filled basket of the catch tank (Fig. 3).

We used a large diameter gas gun and a planar flyer impact so that the embedded gauges measured stress over an area large enough to be representative of the response of the bulk material (the order of 10 to 20 grain diameters) and were subjected to uniaxial strain conditions. The planar impact also helps to preserve the time resolution of the experiment because non-planar waves propagating across the lateral dimension of a large-area gauge produce apparent stress rise and fall times that are longer than their actual values.

The large barrel diameter delays the effects of release wave propagation from the lateral edge of the snow target (edge waves), which degrades the uniaxial strain field in the snow. When the shock wave arrives at the target, release waves are generated at its lateral edge or free surface and propagate toward the target center. They propagate faster than the initial shock wave, thus reducing the region of uniaxial strain. Figure 4a diagrammatically illustrates how the faster release waves overtake shock waves (for a target that is made from the same material as the flyer). The “uniaxial strain cone” has its base at the impact surface and its apex on the centerline of the sample. The cone angle  $\alpha$  increases as the ratio of the release wave velocity to the incident shock wave velocity increases, so that a large cone angle indicates that the region of uniaxial strain is relatively small.

It was necessary to add a buffer plate in our experiments to prevent the snow from evaporating in the evacuated target chamber and to ensure planarity of the contact between the projectile and the target. Adding such a buffer plate with a high shock velocity at the impact end of the snow target further reduces the zone of uniaxial strain. The release waves generated at the edge of the buffer plate propagate across the buffer/snow interface

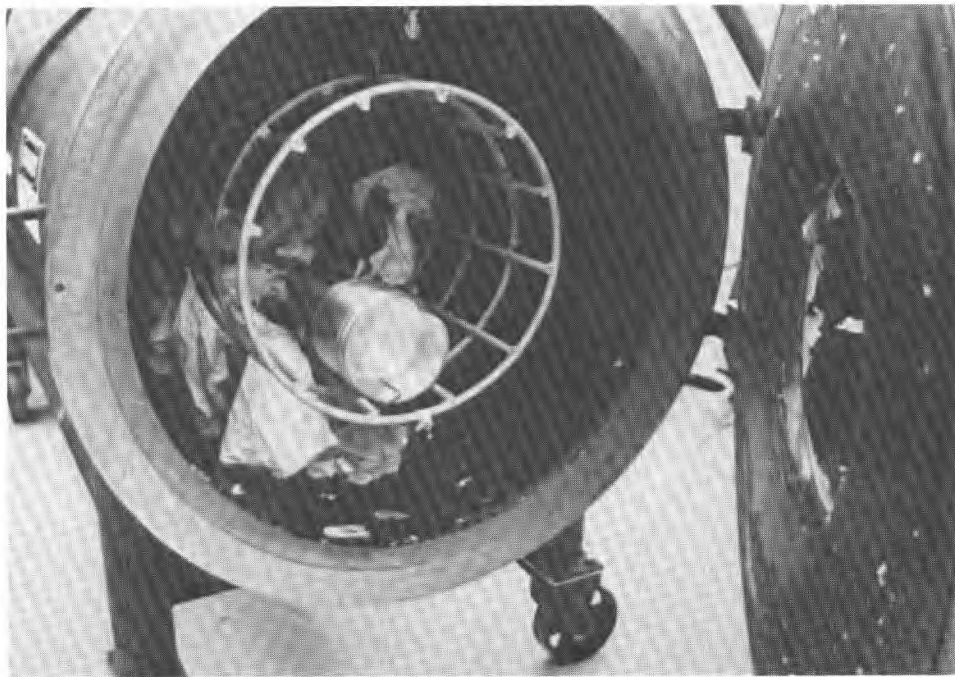
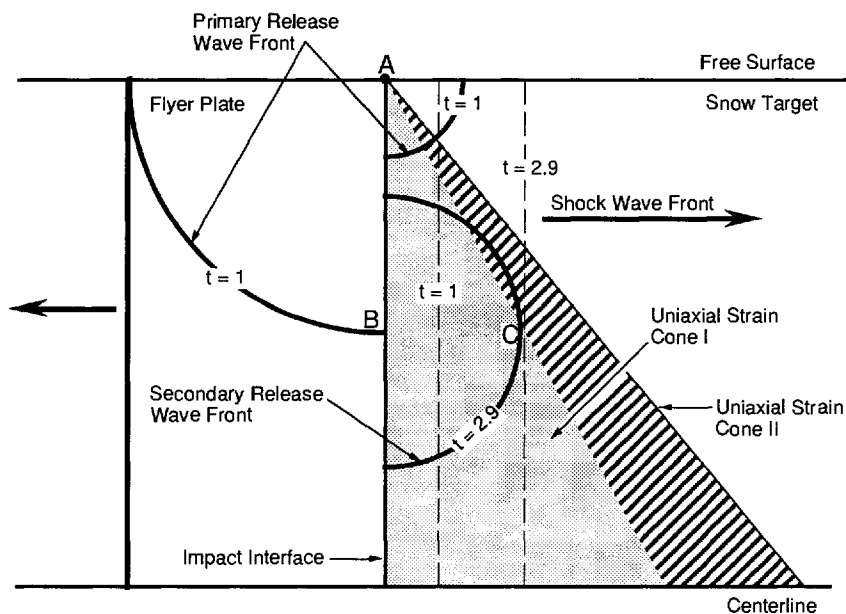
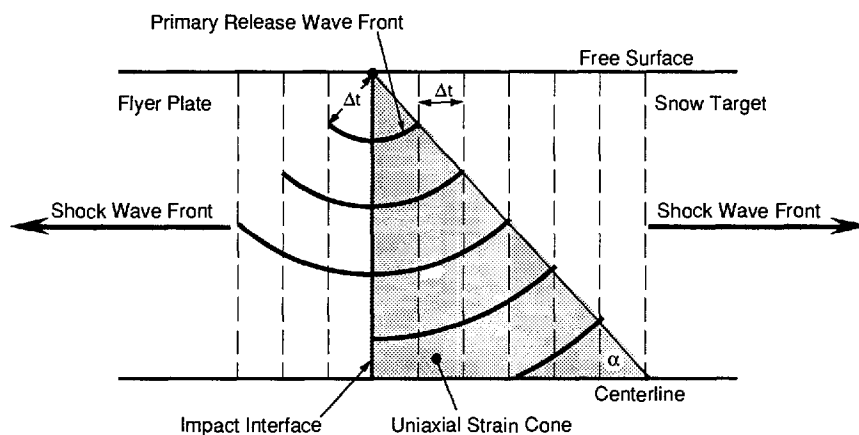

Figure 3. Spent projectile in the catch tank's rag-filled basket.



a. For a flyer and target made from the same material. Equal time increments separate the shock front contours. The distance traveled during a given time increment is greater for the primary release wave than for the shock wave.



b. For a flyer and target made from different materials, in which the shock wave speed in the flyer is five times that in the target (uniaxial strain cone I). The origin of primary release waves in the flyer and target is the point at which the impact surface meets the free surface A. A secondary release wave with its origins at B, the interface between the target and flyer, is superimposed on the uniaxial shock wave at C. The uniaxial strain cone II is produced by propagation of primary release waves in the target and is the same as the uniaxial cone shown in Figure 4a.

Figure 4. Uniaxial strain impact cones for a flyer and target.

(B in Fig. 4b) and are superimposed on the uniaxial shock waves (C in Fig. 4b). Figure 4b illustrates the difference between the uniaxial cone produced by a high wave speed buffer (uniaxial cone I) and a flyer made from the same material as the target (uniaxial cone II). Uniaxial cone II is the same whether a buffer plate is present or not, since the primary release wave speed in the snow is the same in both cases. The uniaxial strain cone is particularly small in snow, as compared to other materials, because the ratio of its release wave velocity to its incident shock wave velocity tends to be greater than for other materials. Even with the large diameter gun, it was not possible to completely eliminate the effects of release waves in our experiment.

#### Snow target assembly

The snow target assembly was designed to:

1. Provide a planar impact surface between the flyer and the target.
2. Protect the snow from the gas gun vacuum.
3. Control the snow temperature prior to an experiment.
4. Maintain an unobstructed shock wave propagation path from the impact surface to a given stress gauge.
5. Position the stress gauges so that they remained in a uniaxial strain field for the maximum possible time.
6. Provide a snow sample with a large cross-sectional area in which to make stress measurements.

7. Measure Lagrangian stresses at three different initial positions in the snow.

8. Obtain two independent stress measurements at each gauge position.

We were able to fully accomplish design objectives 1–6 and were partially successful at accomplishing 7 and 8. Our stress measurements were not strictly Lagrangian and only one stress measurement was made in the last instrumented snow layer because of a limitation of available signal recording channels.

Our target assembly consisted of a copper cylinder surrounding four disk-shaped snow layers with stress gauges installed at the layer interfaces (Fig. 5). Aluminum end-plates capped the cylinder and made a vacuum-tight seal to prevent the snow from evaporating. Copper tubing wrapped around the outer cylinder allowed the use of cold nitrogen gas to cool the target after it was mounted on the gas gun.

We tried two gauge mounting schemes in an effort to find the best gauge performance configuration.

In one, the gauges were mounted on pedestals attached to the inner wall of the copper cylinder (Fig. 5a) and, in the other, polymethyl methacrylate (PMMA) rings were used to hold the snow and mount the gauges (Fig. 5b). Both methods produced similar gauge performance and we chose to use the PMMA rings because they allowed for more accurate gauge placement and easier snow target construction.

Figure 6 shows the snow sample target assembly at several construction steps. We first glued a thin backing plate (B in Fig. 5) to the front end-plate (A in Fig. 5), with stress gauge 1 (Fig. 6a) sandwiched between them to measure the impact stress. Both plates were of aluminum tooling plate to ensure flatness. PMMA rings with a thickness equal to the desired gauge spacing in the snow were used as templates to cut thin wafers of natural, undisturbed snow and as a confining form to hold the snow in place on the backing plate (Fig. 5b and 6b). Three 12.7-mm-thick wafers of snow were stacked in order, with stress gauges placed gently on top of

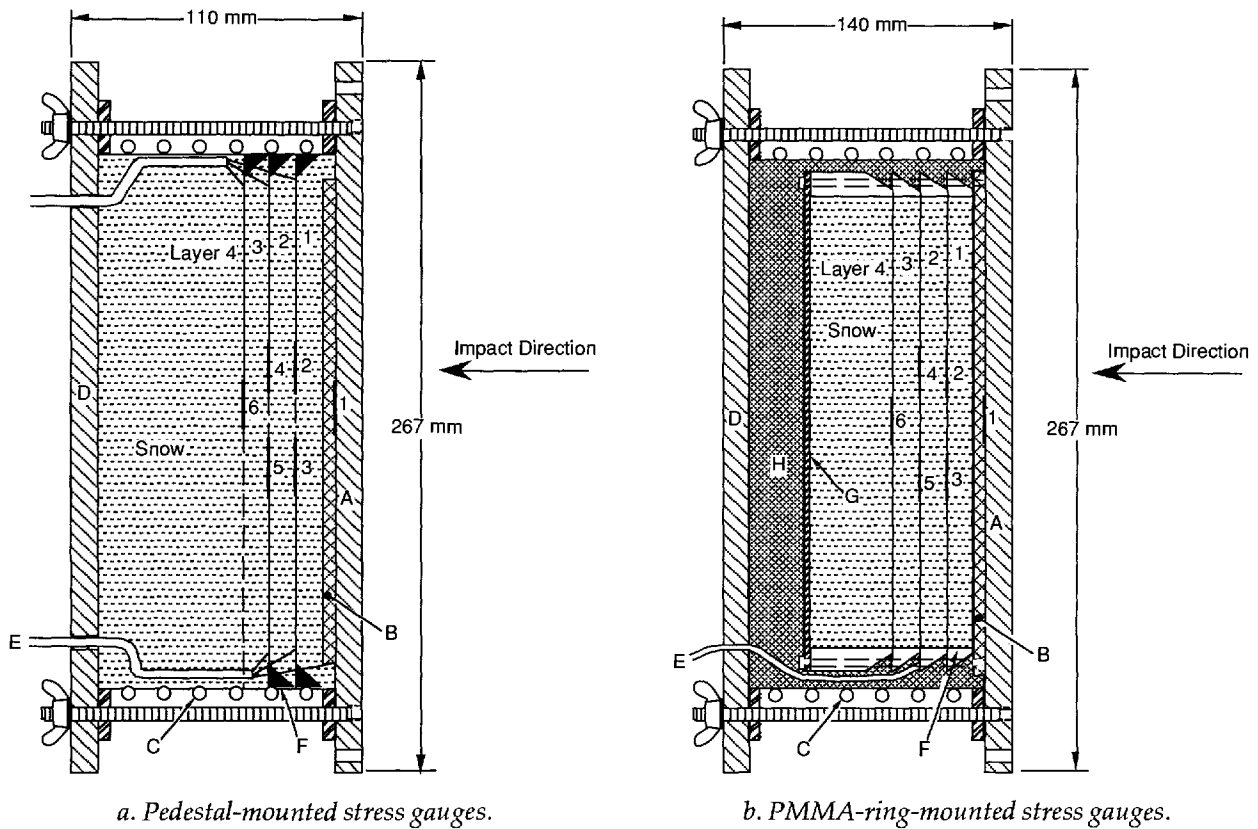

a. Pedestal-mounted stress gauges.

b. PMMA-ring-mounted stress gauges.

Figure 5. Snow target design schematics. The snow target consists of an aluminum buffer plate (A and B) with a carbon gauge (1), a cooling coil (C), a support plate (D), gauge and thermocouple leads (E) exiting the rear surface and aluminum pedestals (F, Fig. 5a) or PMMA rings (F, Fig. 5b), which define the thickness of the snow layers. In addition, the snow target shown in Figure 5b contains a back support plate made of PMMA for the snow (G) and foam insulation (H).

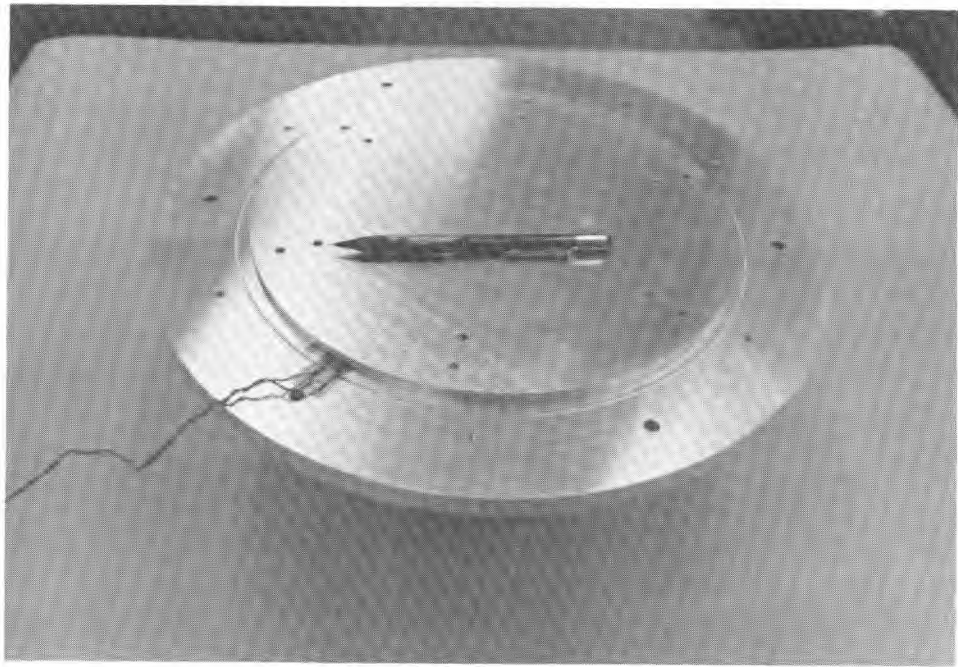

*a. Front end-plate (12.7 mm thick) with epoxyed stress gauge and 6.35-mm-thick backing plate on top.*

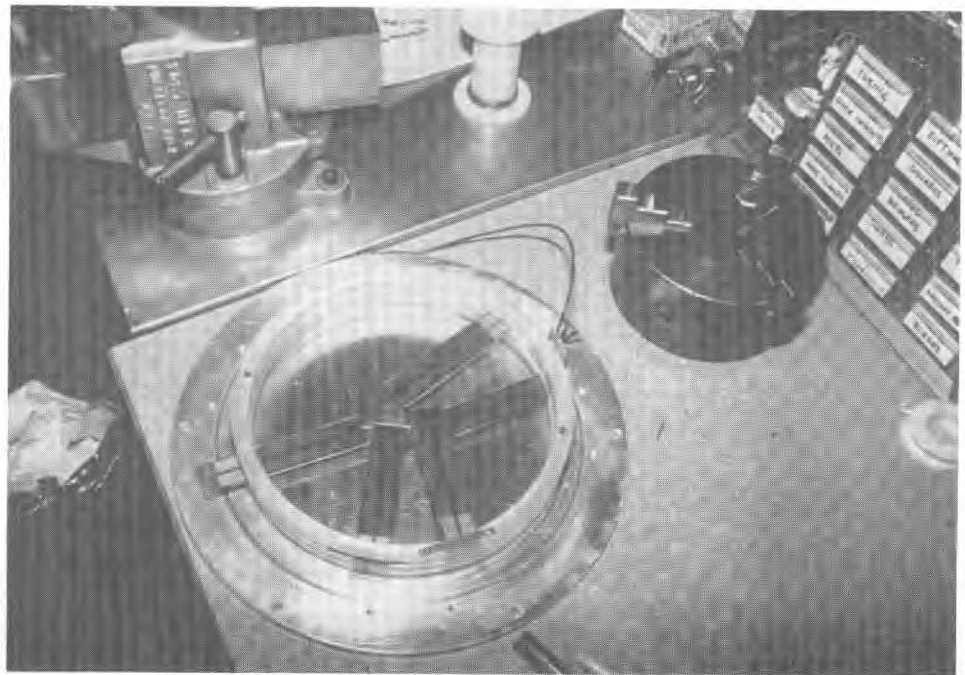

*b. Aluminum buffer plate with PMMA rings and mounted gauges.*

*Figure 6. Snow target construction.*

each successive layer (Fig. 6c and d). Each layer was "salted" with a one-grain-thick layer of sieved snow as a bonding agent and filler. A small thermocouple was placed between two of the snow layers. The stress gauge and thermocouple leads were held in place at the wafer edge by thin metal strips screwed to the PMMA rings. A fourth snow layer,

38.1 mm thick, was placed at the top of the stack and was used to delay the return of reflected stress waves from the rear of the target assembly (Fig. 5b). Finally, a thin PMMA plate was used to cap the assembly, completely confining the stack of snow wafers (Fig. 6d). The final target assembly had one gauge between the buffer and backing plate, two



*c. Snow wafers and gauges installed at an intermediate stage of target construction.*

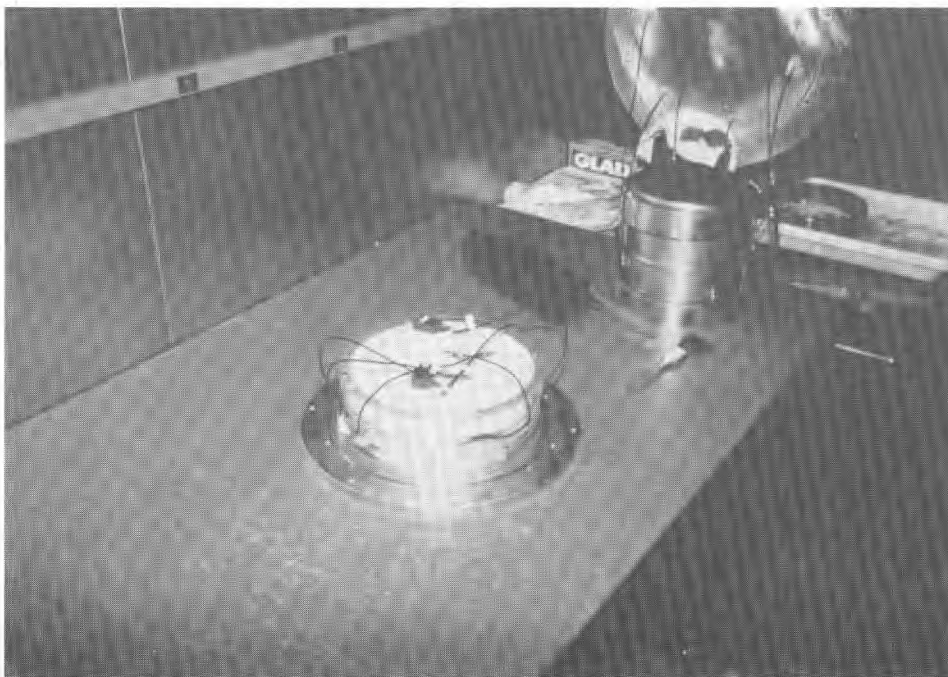

*d. Stacked snow wafers.*

*Figure 6 (cont'd). Snow target construction.*

gauges between snow layers 1 and 2 (gauge plane I), two gauges between layers 2 and 3 (gauge plane II) and one gauge between layers 3 and 4 (gauge plane III). Placing two gauges on the gauge planes provided a backup in case of gauge failure and two stress records in gauge planes I and II that could be compared to each other. The gauges were oriented

such that there was a clear path through the snow from the impact surface to each gauge element. Gauge elements were placed as close to the target center as possible to be within the cone of uniaxial strain (Fig. 4a and b).

The final step in target assembly was to place the outer copper cylinder with its sealing rings on the



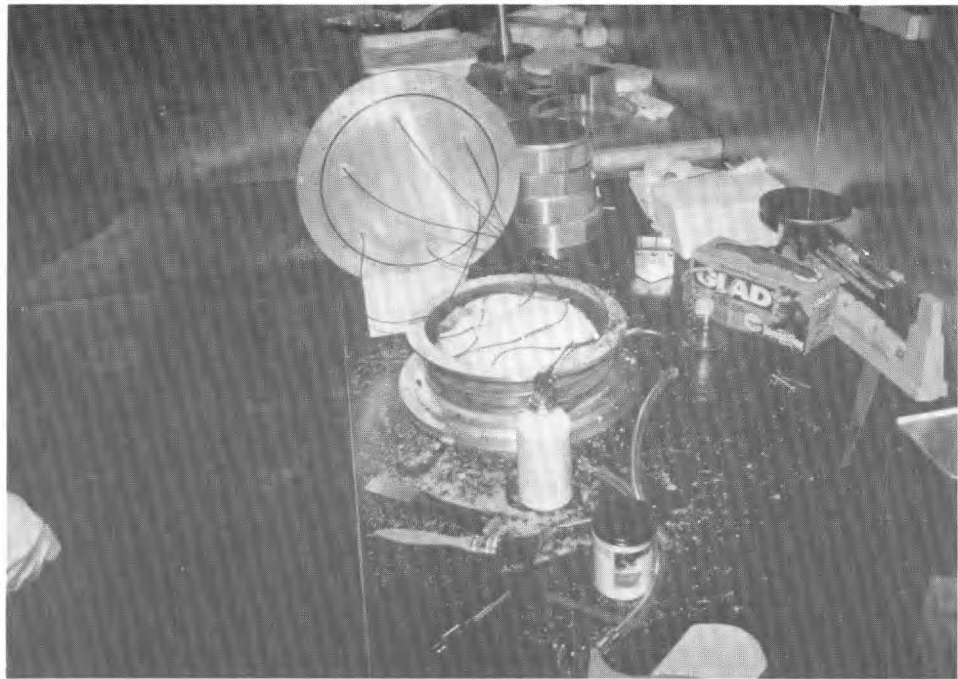

*e. Installation of copper cooling sleeve.*



*f. Completed target.*

*Figure 6 (cont'd).*

front end-plate with its O-ring seal. The gauge and thermocouple wires were passed through sealed holes in the back end-plate (Fig. 6e). The annular space between the PMMA stack and copper cylinder was filled with sieved snow and a foam plug was placed on top of the PMMA stack. Finally, four retaining rods were installed to connect the front

and back end-plates (Fig. 6f). The target assembly was allowed to equilibrate at the desired test temperature in the coldroom. During this time, the snow wafers sintered together, making the sample more uniform and competent.

In our experiments we used naturally deposited snow and manufactured snow having densities

**Table 1. Experimental conditions for snow test samples.**

<i>Test number</i>	<i>Test temperature (°C)</i>	<i>Snow density (kg m<sup>-3</sup>)</i>	<i>*Snow sample description</i>
G009	-6.8	400	Artificial snow sample made by sieving natural snow through a number 14 screen (1.4 mm) and allowing it to sinter for 96 hours. Snow crystals were coarse-grained equilibrium form with a grain size of 1.0–2.0 mm (F31rE[1.0–2.0]).
G010	-8.0	400	Sample preparation was the same as G009. Sintering time was greater than 24 hours.
G011	-5.9	400	Sample preparation was the same as G009. Sintering time was greater than 24 hours.
G013	-10.0	431	Well-bonded, refrozen, coarse-grained clusters (F6mfE[1.0–2.0]).
G014	-9.8	375	Same as G013.
G015	-10.2	305	Well-bonded, fine-grained equant snow. Grain bond necks are about 90% of the grain diameter (F3srE[0.2–0.5]).
G016	-9.8	301	Same as G015.
G017	-9.6	120	Weakly bonded, new dendritic snow with some equilibrium metamorphism and grain bonds at contact points. Many grains were mechanically broken (F2dcE0.5).
G018	-10.2	241	Well-bonded, fine-grained, equilibrium snow grains, rounded to sub-rounded terminations of elongated grains with some blunt faceting. Grain bond necks are 60 to 90% of the grain diameter (F3mxE [0.2–0.5]).
G019	-10.0	240	Same as G018.
G020	-9.9	229	Same as G018.
G021	-1.8	223	Well-bonded, fine-grained equilibrium snow with bond necks 75 to 80% of grain diameter (F3srE0.3).
G022	-19.9	261	Same as G021.
G023	-9.8	103	New dendritic snow with little metamorphism and no observable bonding. Snow cohesion is the result of interlocking dendritic arms (F1sdE0.5).
G028	-7.8	308	Well-bonded, old, fine-grained equilibrium snow (F3srE[0.2–0.5]).
G029	-10.4	300	Same as G028.
G030	-9.0	300	Same as G028.
G031	-10.5	376	Well-bonded, fine-grained equilibrium snow with nearly equant grains. Bond necks are about 50% of the cross-sectional area of grains (F3srE[0.2–0.5]).
G032	-9.6	376	Same as G031.
G033	-9.9	378	Same as G031.
G034	-10.0	520	Artificial snow sample made by sieving new snow through a number 14 screen (1.4 mm) and allowing it to sinter for more than 24 hours. Snow crystals were fine-grained equilibrium form (F3srE[0.2–0.5]).
G035	-10.1	202	Partially decomposed and fragmented new dendritic snow. Snow crystal edges and points are rounded with some inter-grain bonding (F2dcE0.5).
G036	-10.1	203	Same as G035.
G037	-16.8	200	Same as G035.
G038	-23.4	200	Same as G035.
G039	-1.8	392	Same as G031.
G040	-2.6	207	Same as G035.
G041	-2.6	207	Same as G035.

\*Snow classification is from Colbeck et al. (1990).





Figure 7. Snow collection site in the Sangre de Cristo Mountains.

ranging from 100 to 520 kg m<sup>-3</sup>. Sintered snow with densities greater than 200 kg m<sup>-3</sup> was collected at field sites near Los Alamos, in the Jemez and Sangre de Cristo Mountains of northern New Mexico. In the field, samples were packed in boxes (Fig. 7) that were covered with dry ice and wrapped in foam rubber. New snow was collected from the parking lot adjacent to the Los Alamos experimental site immediately after a snow storm to minimize damage during transport. Samples were stored at -40°C to prevent metamorphic changes. The samples included several different snow structure types that are described in Table 1.

### Data acquisition

#### *Projectile velocity and tilt*

The projectile velocity and tilt were determined just prior to impact with the target by an array of six self-shortening pins (manufactured by Dynasen, Inc., Goleta, California), which projected up the barrel from the target plane (Fig. 1 and B in Fig. 2a). The pins were equally spaced around a circle with a diameter slightly less than the gas gun barrel so that the outer rim of the projectile struck the pins without interfering with the impact of the flyer on the target. Pins of different length were used to minimize errors in determining velocity caused by projectile tilt. As each pin was shorted by the pro-

jectile impact, a signal was recorded on a digital oscilloscope. A least-squares fit of the shorting times versus pin lengths was used to calculate a linear function of the arrival times, from which the projectile impact velocity was determined (Table 2). The measured pin lengths were compared to the fitted pin lengths to calculate the projectile tilt, following the method of Wackerle et al. (1975). The standard deviation of the impact velocity varied from 0.4 to 2 m s<sup>-1</sup> and the tilt deviations were less than 0.1 mrad.

#### *Stress gauges*

We measured stress-time records in the target assembly using 50-Ω carbon-film piezoresistive gauges manufactured and calibrated by Dynasen, Inc. The active areas of the gauges used in the snow and on the aluminum were 0.75 × 1.25 cm and 0.5 × 0.25 cm respectively. Carbon stress gauges were used because of their relatively high sensitivity in the low stress regime (< 1 GPa) and their robust construction. The high sensitivity allowed low excitation power and thus less Joule heating of the gauges during the experiment. Also, the active element of the carbon gauge forms a single, continuous, wide strip rather than a grid, as is the case for the more commonly used manganin and ytterbium gauges. Therefore, it is less susceptible to destruction by puncture.

**Table 2. Experimental conditions for flyer plate and stress gauges.**

<i>Test number</i>	<i>Flyer plate material</i>	<i>Impact velocity (m s<sup>-1</sup>)</i>	<i>*Stress gauge position (mm)</i>	<i>Gauge armor and total thickness (mm)</i>
G009	PMMA	141.7	12.3	Mica/0.41
			13.1	0.61
			25.4	0.38
			26.7	0.64
			38.1	0.64
G010	PMMA	150.8	15.2	0.81
			16.6	0.66
			28.3	0.69
			26.2	0.51
			38.1	0.58
G011	PMMA	144.8	15.2	0.50
			14.2	0.40
			25.7	0.50
			26.2	0.38
			38.1	0.46
G013	Aluminum 1100-0	167.2	16.5	Unclad/0.09
			16.5	Mica/0.57
			29.7	0.43
			29.7	0.55
			38.9	0.51
G014	Aluminum 1100	166.3	13.0	0.39
			13.5	0.25
			25.0	0.39
			25.0	0.45
			37.6	0.41
G015	Aluminum 1100-0	166.4	13.2	0.41
			13.7	0.29
			24.8	0.43
			24.6	0.34
			37.6	0.33
G016	Aluminum 1100-0	163.0	14.0	Mica/0.28
			14.4	0.30
			27.2	0.32
			28.4	0.23
			41.7	0.29
G017	Aluminum 1100-0	166.6	13.1	0.33
			12.3	0.24
			23.7	0.25
			23.7	0.20
			37.6	0.25
G018	Aluminum 1100-0	167.7	14.0	0.30
			14.5	0.26
			24.6	0.28
			24.6	0.29
			37.6	0.33
G019	Aluminum 1100-0	166.7	13.8	0.36
			14.5	0.33
			25.0	0.30
			24.9	0.30
			37.6	0.29

Table 2 (cont'd).

<i>Test number</i>	<i>Flyer plate material</i>	<i>Impact velocity (m s<sup>-1</sup>)</i>	<i>*Stress gauge position (mm)</i>	<i>Gauge armor and total thickness (mm)</i>
G020	Aluminum 1100-0	166.6	13.3	0.37
			12.8	0.39
			24.5	0.37
			25.0	0.28
			37.6	0.28
G021	Aluminum 1100-0	166.8	14.5	0.42
			13.2	0.39
			24.9	0.39
			24.6	0.37
			37.6	0.38
G022	Aluminum 1100-0	167.0	13.2	Mica/0.40
			13.2	0.38
			24.1	0.34
			24.2	0.36
			37.6	0.35
G023	Aluminum 1100-0	167.2	13.2	0.39
			12.2	0.40
			25.2	0.37
			24.7	0.39
			37.6	0.36
G028	Aluminum 1100-0	165.9	12.7	Unclad/0.08
			12.7	Mica/0.28
			25.7	Electroply/0.23
			24.7	Foam/0.33
			37.6	Kapton/0.33
G029	Aluminum 1100-0	165.9	13.2	Electroply/0.42
			12.8	Kapton/0.37
			24.9	Kapton/0.28
			25.0	Electroply/0.28
			35.6	Kapton/0.36
G030	Aluminum 1100-0	166.8	12.5	Electroply/0.46
			12.8	Kapton/0.45
			24.8	Electroply/0.45
			24.8	Electroply/0.30
			37.6	Electroply/0.28
G031	Aluminum 1100-0	104.4	12.7	Unclad/0.08
			12.7	Electroply/0.33
			23.9	Unclad/0.08
			23.9	Kapton/0.33
			38.1	Electroply/0.23
G032	Aluminum 1100-0	104.0	13.6	Electroply/0.41
			12.7	Electroply/0.36
			26.3	Electroply/0.43
			26.2	Kapton/0.41
			37.6	Electroply/0.43
G033	Aluminum 1100-0	104.0	12.1	Kapton/0.38
			11.8	Electroply/0.41
			26.2	Kapton/0.38
			25.7	Electroply/0.43
			38.1	Electroply/0.41

**Table 2 (cont'd). Experimental conditions for flyer plate and stress gauges.**

<i>Test number</i>	<i>Flyer plate material</i>	<i>Impact velocity (m s<sup>-1</sup>)</i>	<i>*Stress gauge position (mm)</i>	<i>Gauge armor and total thickness (mm)</i>
G034	Aluminum 1100-0	103.6	13.1	Electroply/0.41
			12.8	Kapton/0.46
			24.5	Electroply/0.42
			24.5	Kapton/0.41
			36.3	Kapton/0.47
G035	Aluminum 1100-0	103.4	12.2	Kapton/0.41
			12.2	Kapton/0.38
			25.0	Kapton/0.41
			25.4	Electroply/0.38
			38.1	Kapton/0.36
G036	Aluminum 1100-0	165.6	11.4	Kapton/0.28
			11.9	Kapton/0.28
			24.1	Kapton/0.28
			22.9	Kapton/0.28
			34.3	Electroply/0.43
G037	Aluminum 1100-0	166.5	12.7	Kapton/0.43
			12.6	0.38
			22.9	0.46
			22.4	0.36
			36.5	0.38
G038	Aluminum 1100-0	165.5	12.7	Kapton/0.36
			12.7	0.38
			24.4	0.38
			24.8	0.36
			36.9	0.36
G039	Aluminum 1100-0	103.1	15.2	Electroply/0.41
			14.7	Kapton/0.36
			26.4	Electroply/0.38
			24.4	Kapton/0.36
			38.1	Electroply/0.41
G040	Aluminum 1100-0	105.2	12.6	Electroply/0.41
			12.6	Kapton/0.36
			25.6	Electroply/0.38
			25.8	Kapton/0.36
			38.1	Electroply/0.41
G041	Aluminum 1100-0	166.7	12.7	Electroply/0.41
			12.9	0.38
			25.3	0.41
			25.2	0.51
			37.9	0.38

\*Gauge positions are for gauges 2 through 6 in the snow relative to the aluminum buffer. Gauge 1, in the aluminum buffer, was 0.09 mm thick for all tests.

The manufacturer encapsulates the gauges between 0.25-mm-thick layers of kapton. In this configuration, the gauges failed or gave unreliable readings. The recording life of the gauges was extended by further armoring them with a 0.006- to 0.28-mm layer of electronic-grade mica, bonded with fast-setting epoxy (Fig. 8). While this procedure improved gauge reliability, it also introduced

a strong impedance mismatch between the gauge and the snow that we attempted to minimize by using a mica cladding just thick enough to prevent gauge failure (about 0.13 mm of mica on each side of a gauge). We also attempted to use kapton, nylon, foam and electroply as the armor material, with little success. Any significant reduction of armor cladding thickness or modulus from the

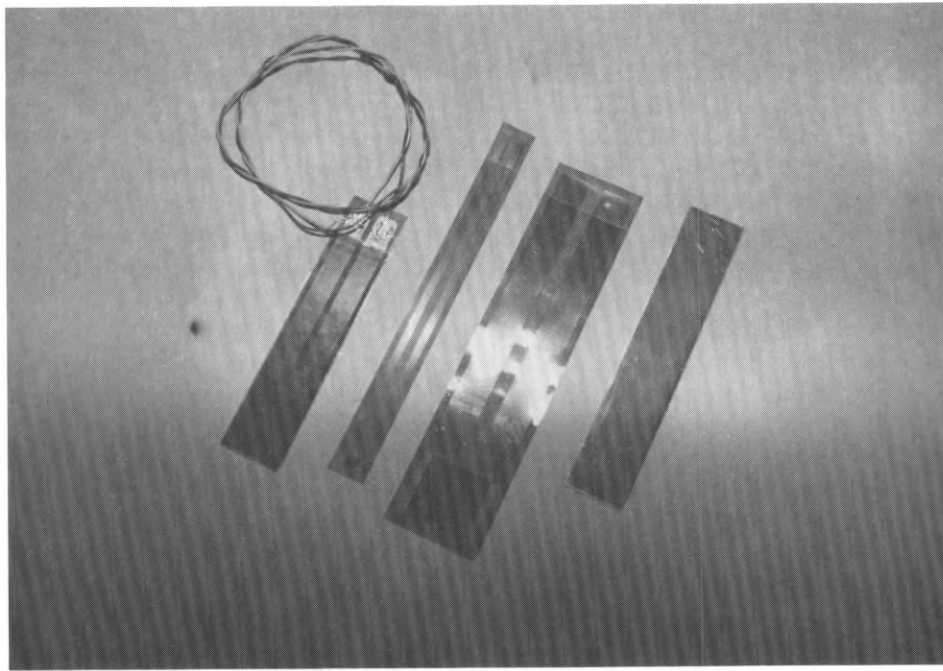

Figure 8. Carbon stress gauges. From left to right: mica clad gauge with attached leads, unclad carbon gauge used in the aluminum buffer, unclad carbon gauge with a large cross section, and electronic grade mica used to armor clad carbon gauges.

0.13-mm mica armor resulted in gauge failures at or shortly after the first shock arrival.

Two different types of carbon stress gauges were used in our experiments. Shock experiments G009, G010, G011, G013, G014 and G015 used the C300-50-EKRTE gauges (manufactured by Dynasen). The calibration for these gauges is (Krehl 1978)

for  $0 \leq \sigma < 50$  MPa

$$\sigma = 1520 \left| \frac{\Delta R}{R} \right|$$

and for  $50 \text{ MPa} \leq \sigma < 10$  GPa

$$\begin{aligned} \sigma = & -73.2 + 4776.6 \left| \frac{\Delta R}{R} \right| - 31,290.8 \left| \frac{\Delta R}{R} \right|^2 \\ & + 154,325.7 \left| \frac{\Delta R}{R} \right|^3 - 274,406.4 \left| \frac{\Delta R}{R} \right|^4 \\ & + 185,062.9 \left| \frac{\Delta R}{R} \right|^5 \end{aligned}$$

where  $\sigma$  = stress (MPa)

$\Delta R$  = resistance change

$R$  = initial gauge resistance

$$\left| \frac{\Delta R}{R} \right| = \text{absolute value of the resistance change ratio.}$$

We used a second carbon gauge—C300-50-EKRTE-SILVER TABS (also manufactured by Dynasen)—for the remaining experiments (experiment G016 and above) after the first gauge was discontinued. We used a polynomial fit to the manufacturer's calibration data to define the calibration curves for the C300-50-EKRTE-SILVER TABS carbon gauges for stresses above 250 MPa. We used a linear extrapolation from zero to the manufacturer's data to define the calibration curve to 250 MPa. Krehl (1978) showed that a straightforward linear extrapolation of the calibration data to zero stress is appropriate for this type of gauge. The calibration equations are

for  $0 \leq \sigma < 250$  MPa

$$\sigma = -2452 \frac{\Delta R}{R}$$

and for  $250 \text{ MPa} \leq \sigma < 3$  GPa

$$\sigma = 129.42 - 741.09 \left( \frac{\Delta R}{R} \right) + 7820.5 \left( \frac{\Delta R}{R} \right)^2.$$

The stress ( $\sigma$ ) is positive and  $\frac{\Delta R}{R}$  is negative for compressive stresses.

The carbon gauges have calibration uncertainties on loading and unloading of between 5 and 10% of the stress at stresses below about 2.0 GPa (Krehl 1978, King and Janée 1987). Reported hysteresis effects range from 0 to 9% of the stress on partial or complete unloading (King and Janée 1987). But our experience in using the gauge in soils and aluminum have not shown evidence of measurable hysteresis. The response of carbon gauges has also been shown to conform well to the manufacturer's calibration when used in porous materials at stresses below about 1.2 GPa (Gourdin and Weinland 1986). Carbon gauges can undergo a signal baseline shift owing to Joule heating when excitation is applied (Krehl 1978, Schmidt and Voss 1987). The shift can be compensated for by measuring the baseline shift of each gauge just before conducting an experiment.

#### *Recording system*

Each carbon gauge formed one arm of a depulsed Wheatstone bridge. Individual power supplies provided a pulse excitation of about 70 V for 200  $\mu$ s. The bridge output signals, representing stress-time histories from each gauge in the target, were recorded digitally using CAMAC-based waveform digitizers.

The analog bandwidth of the recording system was 1 MHz, with an eight-bit dynamic range, and the waveforms were recorded at either 4 MHz (0.25  $\mu$ s/point) or 2 MHz (0.5  $\mu$ s/point). Each recording channel had 32 kilobytes of memory available at a 4-MHz recording rate, or 16 kilobytes at 2 MHz, so each record, regardless of recording rate, was 8 ms long. This gave us considerable flexibility in setting the recording trigger, since gauge stress signals were at most 200  $\mu$ s long.

#### **Experimental procedure**

Before we conducted an experiment, the initial stress amplitude and duration of the shock wave were estimated to set the operating range of the gas gun and data recording system. The stress amplitude and duration were controlled by the choice of flyer material and its thickness, and the projectile impact velocity. We used "impedance match" techniques (Rinehart 1975), with the estimated projectile velocity and the Hugoniot data of the flyer, buffer plate material and snow, to estimate the initial stress amplitudes in the snow. Tabulated shock data were used for the aluminum flyer (Marsh 1980) and the initial snow behavior was estimated from the data of Napadensky (1964) and Sato and Brown (1983). Estimates of the shock pressures in the snow improved as more data became available during our experimental program.



*Figure 9. Snow target mounted in the gas gun target chamber.*



A 35.9-mm-thick PMMA flyer plate was used in three initial experiments. In the 25 subsequent experiments, 50.8-mm-thick 1100-0 aluminum flyers were used to avoid multiple wave structures that can arise because of yielding effects at low shock pressures (< 100 MPa) and to match the impedances of the flyer and buffer plates.

Each shock loading experiment was conducted in the following manner: First a projectile-flyer assembly was loaded into the breech and fixed in place with retaining pins. Then the breech plug was installed and the breech pumped out to a vacuum of about 8 Pa behind the projectile. Next, the target sample was brought from the coldroom and mounted on threaded nylon studs, 2 cm in front of the muzzle (Fig. 1). The refrigeration coils on the target canister were connected to cold nitrogen gas supply lines, inside the target chamber (Fig. 9), and were immediately started to maintain the target within 0.5°C of the desired temperature. The instrumentation wires from the target were connected to the recording device and the catch tank was sealed against the target chamber. The air in the target chamber-barrel assembly and the catch tank was then evacuated.

When the sample target temperature and vacuum pressures reached the desired values, we balanced the stress gauge bridges, measured the baseline offset records and fired the projectile. After firing, any remaining snow debris was removed from the catch tank to the adjacent coldroom for examination and analysis.

## MEASURED DATA

### Stress histories

The experimental program's results can be separated into three groups. Group I (G010, G015 and G016) resulted in complete stress records from all target gauges. Group II results include some complete stress records and some partial records that provide arrival time information only, because the gauges failed just after the shock arrival. Experiments G011 and G020 in Appendix A are examples of group II data. Group III results consist of only partial stress records, which provide arrival time information only. Experiment G019 in Appendix A is an example. We obtained stress information for the gauge in the aluminum buffer for all but four of our experiments.

For those experiments with complete stress information, the records for gauges 2 and 3 in gauge plane I and gauges 4 and 5 in gauge plane II

generally agree (Fig. A2 for shot G010 is an example). Also, the quasi-steady stresses (the relatively steady stress magnitude that occurs after the initial shock arrival at a gauge location) for gauges 2 and 3 are on the same order as estimated using Rankine-Hugoniot theory (for example, experiments G010 and G016) (Johnson et al. 1990). These findings suggest that the measured records are valid and that release waves from the aluminum buffer did not significantly affect them. The effect of the release waves are discussed in detail in Johnson et al. (1992a).

### Snow characterization

We classified our snow samples in an effort to determine what characteristics might significantly affect the compaction behavior of snow under shock loading.

The snow samples were characterized by temperature, density, crystal size and type, and texture and classified according to *The International Classification for Seasonal Snow on the Ground* (Colbeck et al. 1990) (Fig. 10 and Table 1). We identified six different types of snow, four of which were highly metamorphosed. These included 1) well-bonded, coarse-grained equilibrium snow, 2) fine-grained equilibrium snow, 3) coarse-grained refrozen snow and 4) fine-grained rounded particles with a few











1 sd		
2 dc		
3 mx		
3 lr		
3 sr		
6 mf		

Figure 10. Snow crystal types composing the snow samples used in the shock experiments. Column 1 lists The International Classification for Snow on the Ground (Colbeck et al. 1990) class designation.

facets (mixed equilibrium and kinetic forms [Fig. 10]). The other two snow types were 5) new dendritic snow and 6) partly decomposed dendritic snow.

We collected sample fragments after each experiment to estimate the final density of the shocked snow. The fragments exhibited deformation rang-

ing from slight compaction through extensive compression to a bubbly ice matrix (Fig. 11), with an overall maximum density of  $860 \text{ kg m}^{-3}$ . The bubbly ice resulted from pressure-induced recrystallization and plastic deformation of snow particles, which produced small ice crystals, with air inclusions.

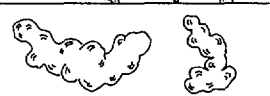
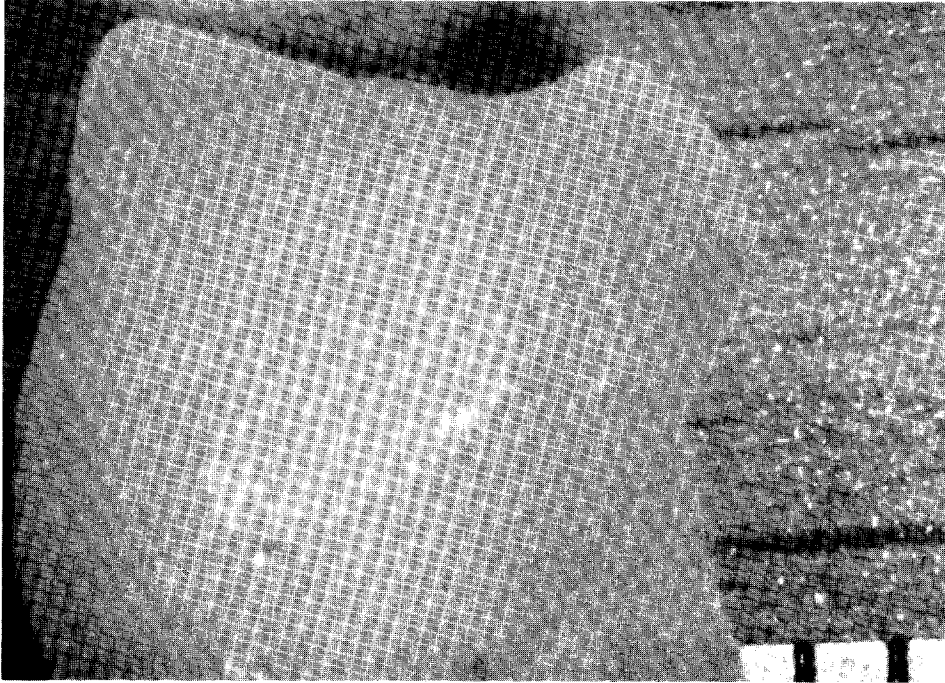

Figure 11. Shocked snow sample that was compacted and recrystallized into fine-grained bubbly ice with a density of about  $860 \text{ kg m}^{-3}$ . The scale at the bottom is in millimeters.

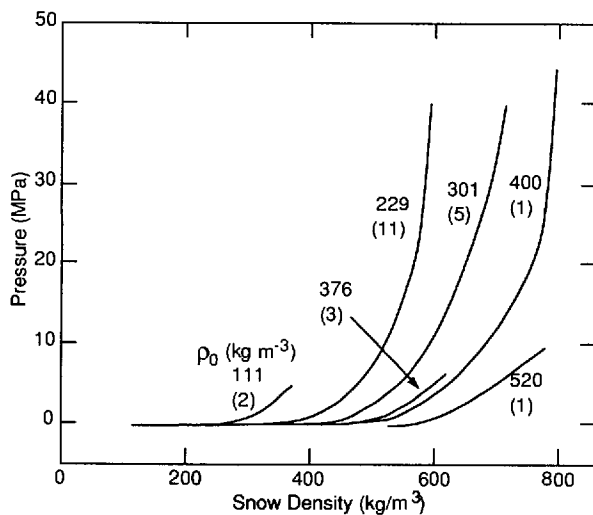

Figure 12. Pressure versus density for snow with initial densities ( $\rho_0$ ) from 100 to  $520 \text{ kg m}^{-3}$  (strain rates greater than  $10^3 \text{ s}^{-1}$ ). The number of experiments used to determine each curve is shown in parentheses after  $\rho_0$  in the figure.

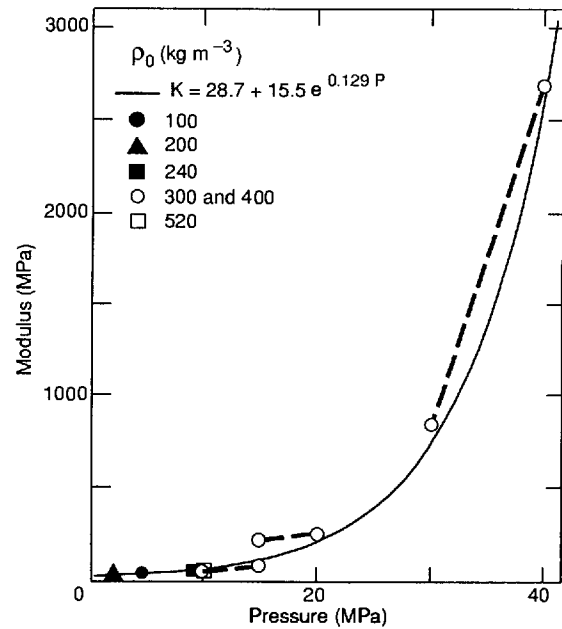

Figure 13. Release modulus for snow ( $K$  is the initial modulus and  $P$  is the pressure at the initial release).

## DATA ANALYSIS

Interpretation of the data from our shock wave experiments and descriptive information about the snow (temperature, densities before and after shock, and snow crystal and structure information) were used to investigate the important parameters that controlled shock wave propagation in snow. Data analysis methods are presented in Johnson et al. (1990, 1992a) and essential shock response information for snow derived from our analysis is sum-

marized in Figures 12 and 13, and Table 3 (Johnson et al. 1992b, 1993). From the data, the pressure–density loading curves in the pressure range from 2 to 20 MPa were well represented by a simple power law function

$$P = a X^b \quad (1)$$

where  $P$  = pressure (Pa)  
 $X$  = density change ( $\rho - \rho_0$ ) ( $\text{kg m}^{-3}$ )  
 $\rho_0$  = initial density  
 $\rho$  = snow density.

**Table 3. Pressure–density values determined from gas gun experiments.**

Density ( $\text{kg m}^{-3}$ )	Pressure (MPa)	Density ( $\text{kg m}^{-3}$ )	Pressure (MPa)	Density ( $\text{kg m}^{-3}$ )	Pressure (MPa)	Density ( $\text{kg m}^{-3}$ )	Pressure (MPa)
<b>Mean density 111</b>		Experiment G020		Experiment G036		<b>Mean density 301</b>	
		229	0.0	204	0.0		
		504	4.0	341	2.4		
		513	4.5	355	3.0	Experiment G015	
Experiment G017		521	5.0	376	4.0	305	0.0
120	0.0	529	6.0	384	4.5	544	4.0
372	2.8	538	7.0			555	4.8
374	3.0	546	8.0	Experiment G037		558	5.0
380	3.5	550	9.0	200	0.0	571	6.0
386	4.0	554	10.0	300	1.7	585	7.0
391	4.5	561	12.0	340	2.3	597	8.0
394	5.0	571	15.0	400	4.3	608	9.0
397	5.5	582	20.0	440	6.5	616	10.0
		590	25.0	489	9.5	632	12.0
Experiment G023		598	30.0			640	13.0
103	0.0	614	40.0	Experiment G038		670	20.0
322	2.9			200	0.0	688	25.0
323	3.0	Experiment G021		360	3.2	705	30.0
328	3.5	223	0.0	375	4.0	740	40.0
332	4.0	498	4.0	392	5.0		
334	4.2	507	4.5	400	6.0	Experiment G016	
		515	5.0	404	6.5	301	0.0
<b>Mean density 229</b>		523	6.0			571	6.0
		532	7.0	Experiment G040		585	7.0
Experiment G018		540	8.0	208	0.0	597	8.0
241	0.0	544	9.0	308	1.1	608	9.0
491	4.0	548	10.0	319	1.3	616	10.0
513	4.5	554	11.5	334	1.6	632	12.0
527	5.0			360	2.0	640	13.0
542	6.0	Experiment G022				670	20.0
554	7.0	261	0.0	Experiment G041		688	25.0
		550	5.0	208	0.0	705	30.0
Experiment G019		560	6.0	358	3.3	740	40.0
240	0.0	570	7.0	372	4.0		
463	4.0	580	8.0	389	5.0	Experiment G028	
477	4.5	585	9.0	397	6.0	310	0.0
491	5.0	590	10.0	404	6.8	500	4.0
513	6.0	600	12.0			507	4.5
527	7.0	610	15.0			513	5.0
542	8.0					526	6.0
554	9.0	Experiment G035				538	7.0
		202	0.0			550	8.0
		323	1.1			557	9.0
		345	1.6			564	10.0
		361	2.0			571	11.0
		366	2.2				



an appropriate experiment, 2) difficulties in obtaining homogeneous, well-characterized snow, 3) experimental methodology (including measurement errors) and 4) proper interpretation of the experimental measurements. All of the published studies on shock waves in snow (including this one) suffer from difficulties in one or more of the above areas (Napadensky 1964, Wakahama and Sato 1977, Sato and Brown 1983, Sato 1987, and others, see Albert 1983). The problems associated with conducting shock experiments on snow have previously not been addressed nor have their consequent effects on the quality of results been reported. To develop an understanding of shock wave propagation and attenuation in snow, it is important to obtain good quality experimental results and to know the errors associated with the measurements.

#### *Experimental design*

In this section we discuss design features that need to be considered when trying to do shock experiments on snow.

The methods most commonly used to study shock waves in porous materials, which are also applicable to snow, are the transmitted wave, shock reverberation and Lagrangian methods. These methods have been reviewed by Seaman (1976) and used by Boade (1968), Lynse et al. (1969), Butcher and Karnes (1969), Larson and Anderson (1979), Lapatin et al. (1989) and others to obtain stress-strain information for shocked materials.

The transmitted wave experiment is done by shooting a flyer at a target backed by a buffer material of known shock behavior. A compression wave propagates from the flyer through the target and is measured by a stress or particle velocity gauge mounted on the front surface of the buffer. Measurements from several transmitted wave experiments are usually needed to construct stress-strain relations.

In a shock reverberation experiment, a flyer constructed from the porous material of interest hits a high impedance reverberation disk, for which the shock behavior is well known. Stress or particle velocity measurements at the reverberation disk surfaces are used to determine the loading and unloading behavior of the flyer.

The Lagrangian method uses a series of stress or particle velocity gauges embedded at different positions in a target. The measured stress or particle velocity histories provide a record of the propagation of a shock wave through the target. These are used with the conservation relations for mo-

mentum, mass and energy to determine the shock response for the target material.

Of the three methods discussed above, the shock reverberation method is the most difficult to apply to snow because a flyer made from snow is fragile and easily damaged during acceleration. Transmitted wave and Lagrangian methods should both be applicable to snow, within the limits of a given experimental design.

Factors that affect shock wave propagation experiments on snow include:

1. The rapid degradation of an applied uniaxial strain field.
2. The presence of high homologous snow temperatures.
3. The low initial density and large density changes that take place during shock compaction.
4. The heterogeneous granular texture of snow.
5. The large attenuation of shock waves in snow.

In the following we present several methods that can be used to deal with the difficulties posed by the above factors.

The time during which a uniaxial strain field is present during an experiment can be increased by increasing the diameter of the flyer and the target. Unfortunately, the diameter of a gas gun is limited by practical construction considerations and it is difficult to handle large-diameter snow samples. A convenient way to increase the diameter of a target and flyer is to conduct large-scale experiments using explosives with the snow transported to or manufactured at the experimental site. Alternatively, the experiments can be done in situ.

The effects of high vapor pressure for snow because of its high homologous temperature may be treated by 1) constructing a vacuum-tight canister to protect a snow target from a gas-gun vacuum, 2) lowering the temperature of the snow target sufficiently so that vapor pressure effects are negligible, or 3) conducting experiments in situ at atmospheric pressure. The occurrence of a phase change in snow can be accommodated by designing an experiment to 1) produce a steady wave with sufficient duration to allow the phase change to occur completely, 2) ensure that gauges are spaced closely enough together to allow resolution of phase changes, or 3) be conducted at temperatures and stresses for which the final phase state is well known and does not change.

Our experiences in trying to compensate for the effects of the low initial snow density and its large change during an experiment apply primarily to stress gauge measurements. We have found that it is difficult, if not impossible, to construct a stress

gauge that will be impedance-matched, survive the initial shock, and provide true Lagrangian records throughout an experiment. The results of this study (Appendix A) and recent work in conducting in-situ shock wave experiments indicate that a heavily armored stress gauge or a gauge backed by a relatively thick plate is sufficient to allow the stress gauge to survive and provide a strong, clean signal (unpublished data). This configuration is similar to a transmitted wave experiment in which each embedded stress gauge acts as a combined gauge and buffer assembly in the transmitted wave configuration. The analysis of measured data for heavily armored gauges is not Lagrangian and the stress-strain behavior must be determined by simulating the experiment.

Analysis of particle velocity gauges embedded in snow indicate that they may not be as affected by impedance differences as are stress gauges.\* If so, it may be possible to obtain particle velocity histories that can be used with the Lagrangian method to directly calculate the stress-strain behavior of snow without the need to simulate the experiment. This is the approach that SRI International personnel are using in their study of shock wave propagation and attenuation in snow.†

High local stresses that are caused by accelerating snow grains can be averaged by using a stress gauge with a cross section of 10 to 20 grain diameters. Puncture damage to a gauge is reduced or eliminated by armoring both sides or by simply placing a stiff backing plate behind it.

Snow is a highly dissipative medium, so that there can be large changes in stress and deformation mechanism over a short distance, affecting attenuation rate, particle velocity and propagation velocity. Several deformation mechanisms can act to influence stress wave propagation and attenuation in snow, including phase change, plastic deformation of ice, plastic pore collapse, loose particle compaction (for shock waves) and anelastic/quasi-elastic vibration (for which a shock wave does not exist). The propagation and attenuation behavior of shock waves and other propagating waves depends on the deformation mechanism that is active. To avoid "smearing" information between different deformation regimes, gauge spacing in an experiment should be on the scale of the deformation mechanisms. For many of the previous shock

wave stress and propagation velocity measurements in snow, gauge spacings used were too great to give useful stress-strain or attenuation information. Such experiments risk averaging the effects of several different mechanisms and experiencing large signal attenuation with consequent inaccuracies.

Prior to using a given experimental design, its feasibility should be examined by simulating the experiment with a computer model. Such a simulation will increase the probability of accomplishing the experimental objective and may identify potential difficulties with the design.

#### *Snow collection, handling and characterization*

To understand the response of snow to shock wave loading, we must start with a well-characterized, representative snow sample. It is, therefore, important that the snow not be greatly affected by collection, handling and characterization procedures. There are four ways to collect snow for use in a shock experiment: 1) by allowing falling snow to collect in the target container, 2) by mining snow from a natural snow cover, 3) by conducting experiments in situ in a snow cover, and 4) by manufacturing snow artificially.

For new snow, samples should be collected near the experimental location and quickly moved into a cold chamber to minimize metamorphic changes and vibration induced settlement. Alternatively, the problems of collecting new snow can be avoided by conducting the experiments in situ. It is possible to mine snow that has some strength from a natural snow cover. A container (for example, a cardboard or aluminum box) with the same or slightly smaller dimensions than the snow sample is lowered over the sample. The bottom of the sample is cut free from the snow cover and covered with a lid (Fig. 7). The container serves to confine the sample, reducing the chances of damage as the snow is transported to the experiment site in a vibration isolated, refrigerated vehicle.

Snow can be artificially manufactured with snowmaking equipment, by chipping ice, or by sieving natural snow through a screen mesh. Snowmaking devices are generally limited to producing ice particles and various forms of rimed snow crystals. They seldom have the capability of producing the intricate dendritic or other new snow crystal forms found in nature.

Snow on the ground can be characterized by grain size, shape and type. In addition, the extent of bonding is estimated and measurements are made

\* Personal communication with Dr. L. Seaman, SRI International, 1992.

† Personal communication with Dr. L. Seaman and D. Erlich, SRI International, 1992.



of snow temperature and, for melting snow, moisture content. Snow grain size, shape and type estimates are generally determined visually with the aid of a magnifying hand lens or microscope. Snow grain bonding is usually estimated with the aid of strength index devices, visually, or by analysis of microtomed thin section or plane section analysis. Moisture content may be determined by dye dilution, calorimetry or dielectric methods.

Target preparation may include embedding stress or particle velocity gauges between snow layers or inserting gauges into a natural snow cover. Snow layers can be made by sifting artificially prepared snow or snow collected during a snowfall into a target canister. If bonded snow is used, the gauges must be inserted into the snow or placed between thin layers of snow. New snow and low-density bonded snow can be cut and transported using thin metal plates with sharpened edges. A thin, fine-toothed saw with little kerf can be used to cut and trim higher density bonded snow. Snow that contains large grains or grain clusters connected by relatively small diameter bonds may fail because of vibrations associated with sawing or cutting (for example, depth hoar or refrozen grain clusters). A thin plate with a heated cutting tip of the same width as the plate may be used to cut thin samples while avoiding vibration damage. Gauges can be placed directly on a snow layer but, in well-sintered snow, it may be necessary to precipitate snow around the gauge between snow layers to accommodate the gauge thickness.

Inserting gauges into snow requires that the gauge assembly be sufficiently stiff so that it will not deform under the force required for insertion. It is also necessary to use a jig to set the gauge insertion positions and to hold the gauges in place during sample construction.

In any gauge installation process, it is critical that the gauges have good contact with the snow. Even a slight air gap between a gauge and snow can produce inaccurate measurements. Slight changes in snow density caused by the gauge insertion procedure produce negligible measurement errors.

#### *Experimental procedure*

The problems of actually doing a shock experiment in snow are essentially the same as those for any other material. Here, we provide information that can be used to increase the likelihood of obtaining good quality data by reducing signal noise, preserving signal fidelity and preventing inadvertent data loss. Data can be lost when recording

channels do not trigger properly, cables lose continuity, or stress gauges and lead wires fail.

Signal quality can be preserved and the effects of external radio frequency noise reduced by using double shielded, twisted-pair, grounded cable that is impedance matched to the data recording device. The cable's frequency and capacitance behavior should be known and its insulation should be cold weather rated for in-situ experiments.

The chances of losing data unintentionally can be greatly reduced by using the following techniques:

1. Multiple triggering sources should be used to redundantly trigger all recording devices. The trigger thresholds should be set to relatively high levels to avoid unintentional trigger signals from ambient noise.

2. Large data storage buffers or appropriately delayed recording devices should be used to obtain data from gauges located downstream from the initial shock impact.

3. Two recording channels (each set to a different sensitivity) per gauge should be used when the shock response of the snow sample is unknown. This will decrease the likelihood of losing data because of incorrectly set gains on the data recorders.

4. Signal fidelity will be increased by using experimental setups that minimize stress and strain gradients across lead wires and gauges. For example, conductor strips and wires leading from a gauge should run downstream from the direction of shock wave travel. Solder connections should be protected from direct shock impact by being covered with tape, epoxy or other protective coating. Gauges in the snow may need to be armored to prevent puncture damage or premature failure. Finally, the transition between a gauge assembly and instrument wiring should maintain similar inertial characteristics to reduce differential accelerations and deformations.

5. Ice, water, cold weather and exposure to shock wave loading can degrade cable performance and cable connection contacts, especially for in-situ experiments. Therefore, it is important to establish a standard operating procedure that includes checking cable continuity, gauge resistance or capacitance (as needed) and the data acquisition system just prior to the experiment.

#### *Data interpretation*

Shock waves propagating in snow often do not exhibit many of the features commonly observed for shocks in other solids. The shock front observed in snow is usually a gradually rising wave, instead

of a sharp transition of material state. Shock wave loading and unloading pressure–density paths differ markedly. These characteristics result in shock wave propagation that is nonsteady, rate-dependent and rapidly attenuating. Consequently, standard single-step Rankine–Hugoniot analysis methods are not reliable for analyzing data. Instead, it is important to obtain stress amplitude, shock wave velocity or particle velocity histories, or all three, that can be analyzed to determine the nonsteady shock wave behavior, for example, by using Lagrangian, transmitted wave or reverberation experiments along with computer simulation methods.

### Experimental needs

Developing stress–strain relations to use in a computational model requires a thorough understanding of the material over the entire stress range of interest. At present, the results of Bakanova et al. (1976) (3.8–35.4 GPa) and the results from the present study (2–40 MPa) appear to be the only data suitable for use in computational modeling efforts for snow. Additional experiments are needed to determine the shock response for snow in the stress range from 0 to about 5 MPa and from 20 MPa to about 4 GPa for dry snow. Thermodynamic methods can be used to estimate behavior at the higher stresses. Experiments are also needed to define the behavior of wet snow and to examine the transition stress range from quasi-elastic wave propagation to shock wave propagation in snow.

Shock response data for snow have been obtained primarily from projectile impact experiments. Such experiments do not allow for penetration of explosive gases into the snow. It is possible that penetration of explosive gases results in less energetic shocks in snow\* (Solie and Johnson, unpublished data). The turbulent flow of gases in the snow pores, and the cooling of gases, may reduce the effective momentum transfer to the snow particles. Experiments to determine the importance of gas penetration would add to our understanding of shock wave propagation in snow.

As experimental methods to investigate shock wave propagation in snow improve, it would be beneficial to verify and extend the results from the

present study. For example, it would be good to re-examine the finding that the stress required to compact snow to a given final density increases with decreasing initial density (Johnson et al. 1993). This finding differs from that of other studies on porous metals (Butcher et al. 1974, Seaman et al. 1974).

### SUMMARY

To predict shock wave propagation and attenuation in snow, it is necessary to obtain information on its compaction response to shock loading (Hugoniot) and unloading release modulus, which determines the release path. Snow, when initially shocked, undergoes a large volumetric compaction that is not reversed when shock pressures are released. This hysteresis between loading and unloading results in rapid attenuation and unsteady propagation of shock waves in snow.

We have conducted laboratory experiments using a 200-mm-diameter gas gun to determine Hugoniot and release moduli for snow. Our experiments were conducted on snow with initial densities of 100 to 520 kg m<sup>-3</sup> at temperatures from -2 to -23°C. Our snow samples consisted of naturally deposited new snow, partially decomposed new snow and several forms of well-metamorphosed snow. We also used artificially processed snow to manufacture samples with densities of 400 and 520 kg m<sup>-3</sup>. Shock stress amplitude and arrival time were measured in the snow using piezoresistive carbon film gauges. Our experiments covered the stress range from 2 to 40 MPa. The stress records were complex and unsteady because of the requirements of our target design and impedance mismatching between the snow and stress gauges.

We collected snow samples after each experiment to estimate the final maximum shocked density and to observe crystallographic changes. Deformation of these samples ranged from slight compaction to extensive recrystallization and compaction to bubbly ice. The maximum bubbly ice density was 860 kg m<sup>-3</sup>.

The complexity of the stress histories in our experiments required us to analyze our data using both a dynamic finite element program and a simple analytical model. Our analysis methods and the resulting descriptions of the shock response of snow are presented in Johnson et al. (1990, 1992a,b, 1993).

---

\* Personal communication with Dr. L. Seaman, SRI International, 1992.

## LITERATURE CITED

- Albert, D.G.** (1983) Review of the propagation of inelastic pressure waves in snow. USA Cold Regions Research and Engineering Laboratory, CRREL Report 83-13.
- Bakanova, A.A., V.N. Zubarev, Yu. N. Sutulov and R.F. Trunin** (1976) Thermodynamic properties of water at high temperatures and pressures. *Soviet Physics-JETP*, **41**: 544–548. (Originally published as *Zh. Eksp. Teor. Fiz.*, **68**: 1099–1107.)
- Boade, R.R.** (1968) Compression of porous copper by shock waves. *Journal of Applied Physics*, **39**(12): 5693–5720.
- Brown, J.A., E.S. Gaffney, G.L. Blaisdell and J.B. Johnson** (1988) Techniques for gas gun studies of shock wave attenuation in snow. In *Shock Compression of Condensed Matter 1987, Proceedings of the American Physical Society Topical Conference, 20–24 July, Monterey, California* (S.C. Schmidt and N.C. Holmes, Eds.). Elsevier Science Publishers, p. 657–660.
- Butcher, B.M. and C.H. Karnes** (1969) Dynamic compaction of porous iron. *Journal of Applied Physics*, **40**(7): 2967–2976.
- Butcher, B.M., M.M. Carroll and A.C. Holt** (1974) Shock-wave compaction of porous aluminum. *Journal of Applied Physics*, **45**(9): 3864–3875.
- Cagnoux, J., P. Chartagnac, P. Hiercil and M. Perez** (1987) Lagrangian analysis: Modern tool of the dynamics of solids. *Annales De Physique*, **12**(5): 451–524.
- Colbeck, S.C., E. Akitaya, R. Armstrong, H. Gubler, J. Lafeuille, K. Lied, D. McClung and E. Morris** (1990) *The International Classification for Seasonal Snow on the Ground*. International Commission on Snow and Ice (IAHS) (available from World Data Center, University of Colorado, Boulder Colorado).
- Cowperthwaite, M. and R.F. Williams** (1971) Determination of constitutive relationships with multiple gauges in nondivergent waves. *Journal of Applied Physics*, **42**(1): 456–462.
- Fowles, R. and R.F. Williams** (1970) Plane stress wave propagation in solids. *Journal of Applied Physics*, **41**: 360.
- Gaffney, E.S.** (1989) Numerical models of shock waves in snow. Final report to CRREL under contract DACA8988M0734, Final Report Ktech TR 89-03.
- Gourdin, W.H. and S.L. Weinland** (1986) Performance of piezoresistive carbon sensors in contact with porous materials. *Review of Scientific Instrumentation*, **57**: 1422–1426.
- Grady, D.E.** (1973) Experimental analysis of spherical wave propagation. *Journal of Geophysical Research*, **78**(8): 1299–1301.
- Johnson, J.B., J.A. Brown and E.S. Gaffney** (1990) Interpretation of the stress histories from shock impact tests on snow using embedded stress gauges. In *Shock Compression of Condensed Matter 1989, Proceedings of the American Physical Society Topical Conference, 14–17 August, Albuquerque, New Mexico* (S.C. Schmidt, J.N. Johnson and L.W. Davison, Eds.). Elsevier Science Publishers, p. 117–120.
- Johnson, J.B., J.A. Brown, E.S. Gaffney G.L. Blaisdell and D.J. Solie** (1992a) Shock response of snow: Analysis of experimental methods and constitutive model development. USA Cold Regions Research and Engineering Laboratory, CRREL Report 92–12.
- Johnson, J.B., J.A. Brown, E.S. Gaffney, G.L. Blaisdell, M. Sturm and S.A. Barrett** (1992b) Shock wave studies of snow. In *Shock compression of Condensed Matter 1991, Proceedings of the American Physical Society Topical Conference, 17–20, June, Williamsburg, Virginia* (S.C. Schmidt, R.D. Dick, J.W. Forbes, and D. G. Tasker, Eds.). Elsevier Science Publishers, p. 107–110.
- Johnson, J.B, D.J. Solie, J.A. Brown and E.S. Gaffney** (1993) Shock response of snow. *Journal of Applied Physics*, **73**(10): 4852–4861.
- King, H.H. and H.S. Janée** (1987) Heating and stress release characterization of piezoresistive carbon gauges. Final report to the Defense Nuclear Agency from Science Applications International, Corp., Final Report SAIC-87/1656.
- Krehl, P.** (1978) Measurement of low shock pressures with piezoresistive carbon gauges. *Review of Scientific Instrumentation*, **49**: 1477–1484.
- Larson, D.B. and G.D. Anderson** (1979) Plane shock wave studies of porous geologic media. *Journal of Geophysical Research*, **84**(B9): 4592–4600.
- Lopatin, C.M., S. Bless and N.S. Brar** (1989) Dynamic unloading behavior of soda lime glass. *Journal of Applied Physics*, **66**(1): 593–595.
- Lynse, P. C., R.R. Boade, C.M. Percibal and O.E. Jones** (1969) Determination of release adiabats and recentered Hugoniot curves by shock reverberation techniques. *Journal of Applied Physics*, **40**(9): 3786–3795.
- Marsh, S.P. (Ed.)** (1980) *LASL Shock Hugoniot Data*. Berkeley, California: University of California Press.
- Napadensky, H.** (1964) Dynamic response of snow to high rates of loading. USA Cold Regions Research and Engineering Laboratory, Research Report 119.

- Rinehart, J.S.** (1975) *Stress Transients in Solids*. Santa Fe, New Mexico: Hyperdynamics.
- Sato, A.** (1987) Velocity of plastic waves in snow. In *Avalanche Formation Movement and Effects* (B. Salm and H. Gubler, Eds.). Association of Hydrological Sciences Publication No. 162, p. 119–128.
- Sato, A. and R.L. Brown** (1983) An evaluation of shock waves in unsaturated wet snow. *Annals of Glaciology*, **4**: 241–245.
- Seaman, L.** (1974) Lagrangian analysis for multiple stress or velocity gauges in attenuation waves. *Journal of Applied Physics*, **45**(10): 4303–4314.
- Seaman, L.** (1976) An evaluation of dynamic experimental methods for porous materials. In *The Effects of Voids on Material Deformations* (S.C. Cowin and M.M. Carrol, Eds.). New York: Applied Mechanics Division of the ASME, p. 125–139.
- Seaman, L., R.E. Tokheim and D.R. Curran** (1974) Computational representation of constitutive relations for porous materials. Final report to Defense Nuclear Agency, SRI International Report DNA 3412F.
- Schmidt, R.M. and M.E. Voss** (1987) Shock measurement and visualization in water. In *Techniques and Theory of Stress Measurements for Shock Wave Applications, Proceedings of ASME Applied Mechanics, Bioengineering, and Fluids Engineering Conference, 14–17 June, Cincinnati, Ohio* (R.B. Stout, F.R. Norwood and M.E. Fourny, Eds.), p. 51–68.
- Wackerle, J., J.O. Johnson and P.M. Halleck** (1975) Projectile-velocity measurements and quartz- and manganin-gauge pressure determination in gas-gun experiments. Los Alamos Scientific Laboratory Report LA-UR-75-5844.
- Wakahama, G. and A. Sato** (1977) Propagation of a plastic wave in snow. *Journal of Glaciology*, **19**: 175–183.

## APPENDIX A: STRESS-TIME DATA PLOTS

Stress-time data plots from all experiments conducted at Los Alamos are presented here. Table A1 summarizes the data in terms of measurement quality by indicating the data that were obtained by each gauge. The table indicates whether a gauge's data record provides information on a shock wave's stress history (stress), arrival time (AT) or if no data were measured. This is a general guide to the raw stress data only and does not provide any interpretation to determine the shock response of snow. Data interpretation and the snow's shock response data are presented in Johnson et al. (1990, 1992a,b, 1993).

**Table A1. Data record quality.\***

Shot number	Stress gauge number					
	1	2	3	4	5	6
G009†	no data	AT stress	AT	no data	AT stress	AT stress
G010	AT stress	AT stress	AT stress	AT stress	AT stress	AT stress
G011†	AT stress	AT stress	AT stress	AT stress	no data	AT stress
G013†	AT stress	no data	AT	AT	AT	AT
G014†	AT	AT	AT	AT	no data	no data
G015	AT stress	AT stress	AT stress	AT stress	AT stress	AT stress
G016	AT stress	AT stress	AT stress	AT stress	AT stress	AT stress
G017	AT stress	AT	AT	AT	AT	AT
G018	AT stress	AT stress	AT stress	AT	AT	AT
G019	AT stress	AT	AT	AT	AT	AT stress
G020	AT stress	AT stress	AT	AT stress	AT	AT
G021	AT stress	AT stress	AT stress	AT	AT	AT
G022	AT stress	AT	AT stress	AT	AT	AT
G023	AT stress	AT	AT	no data	AT	no data
G028	AT stress	no data	AT	AT	AT	AT
G029	AT stress	AT stress	AT	AT	AT	AT
G030	AT stress	AT	AT	AT	AT stress	AT stress
G031	AT stress	AT	no data	no data	AT	no data
G032	AT stress	AT	AT	AT	AT	no data
G033	AT	AT	AT	AT	AT	AT
G034	AT stress	AT	AT	AT	AT	AT
G035	AT stress	AT	AT	AT	AT	no data
G036	AT stress	AT	AT	AT stress	AT stress	AT
G037	AT stress	AT	AT	AT	AT	no data
G038	AT stress	AT	AT	AT	AT	no data
G039†	AT stress	AT	AT	AT	AT	no data
G040	AT	AT	AT	AT	AT	AT
G041	AT stress	AT	AT	AT	AT	no data

\* AT is an abbreviation for arrival time.

† These tests were not used to develop the eq 1 and 2 curves for pressure-density.

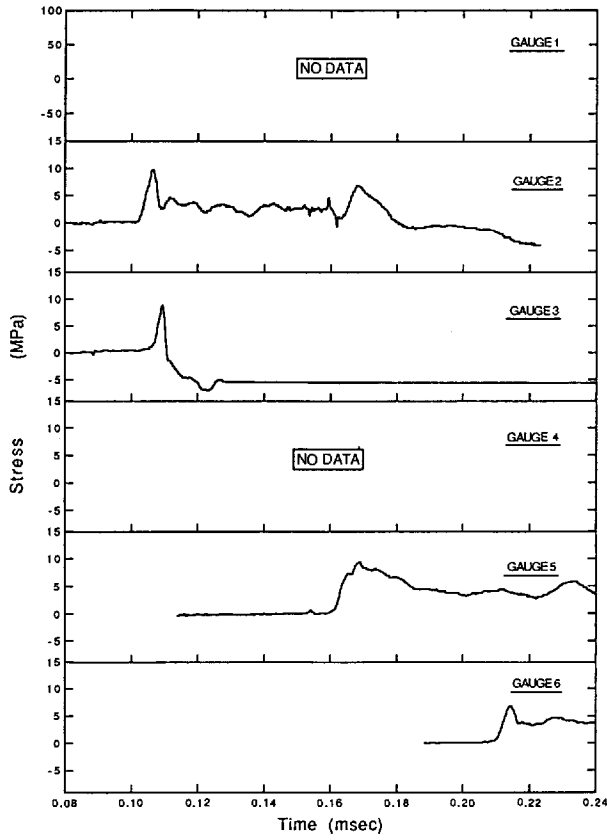

Figure A1. Shot G09.

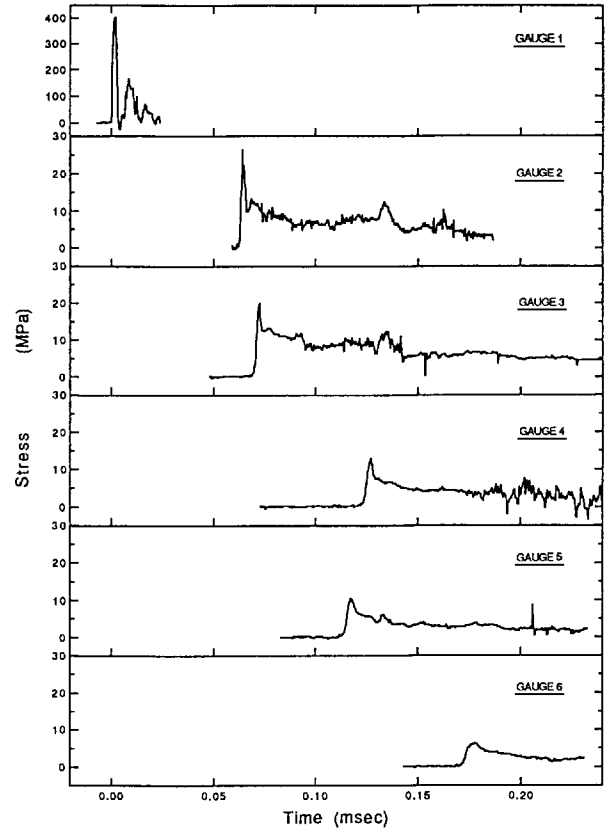

Figure A2. Shot G010.

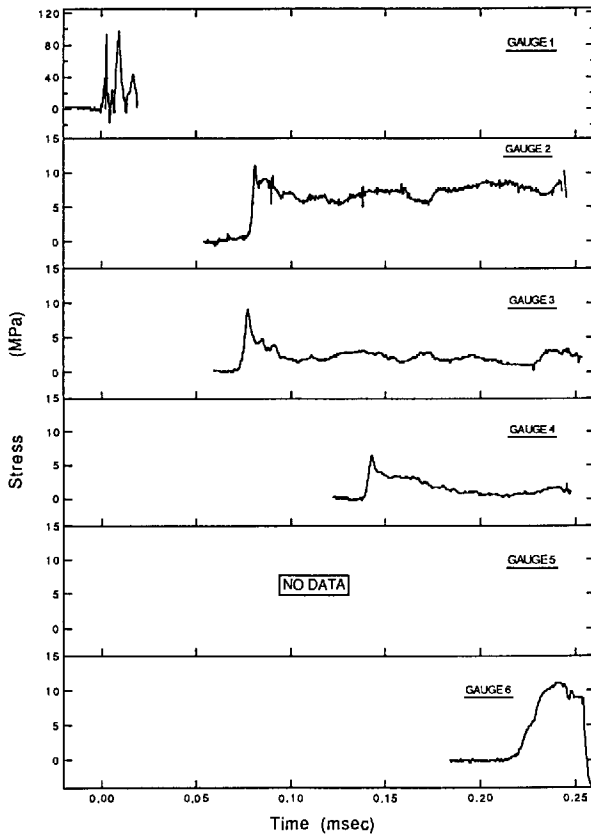

Figure A3. Shot G011.

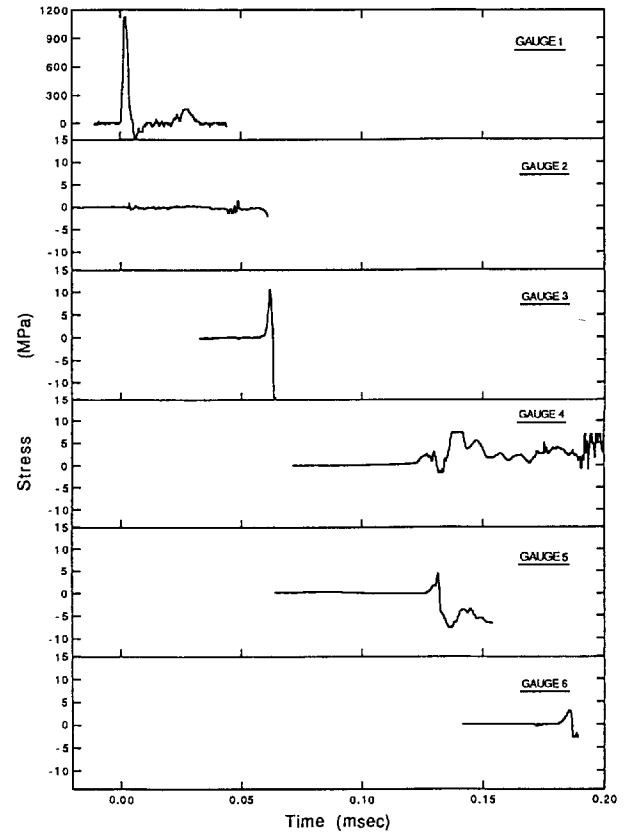

Figure A4. Shot G013.



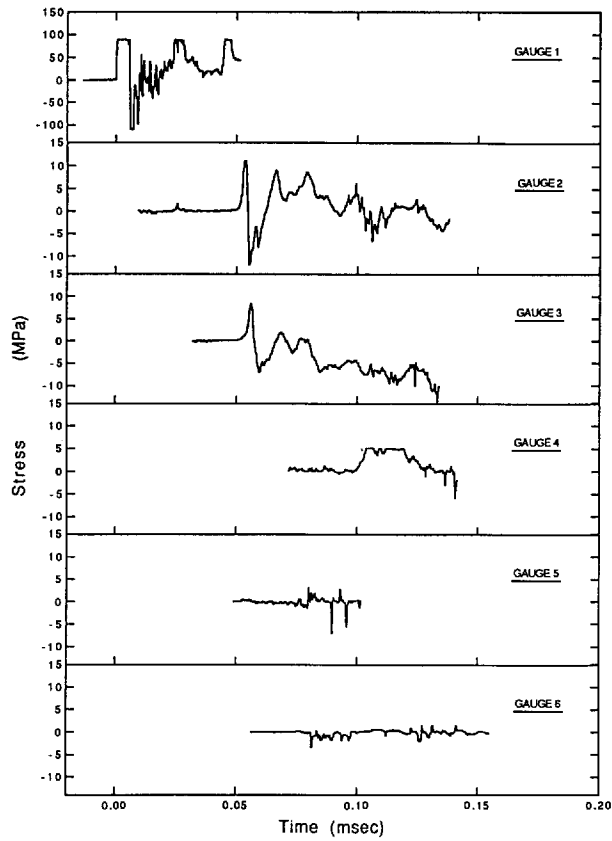

Figure A5. Shot G014.

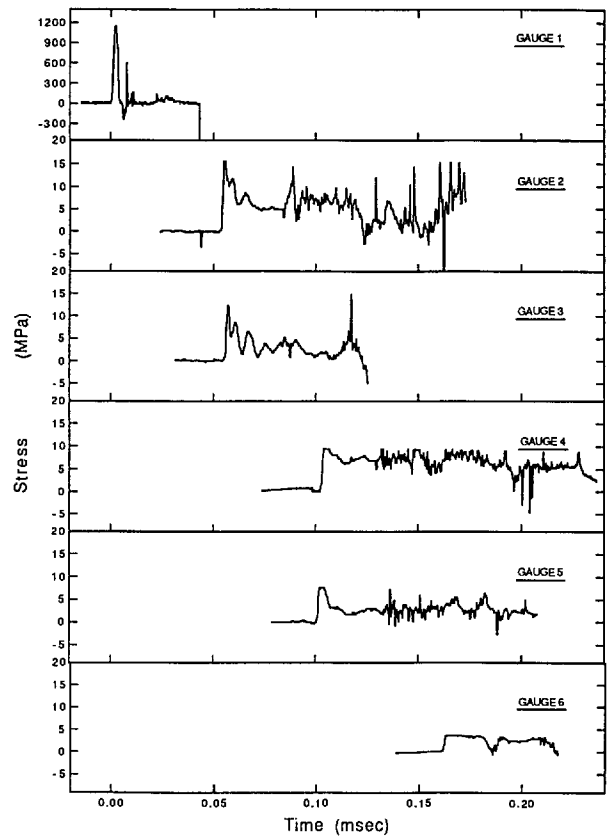

Figure A6. Shot G015.

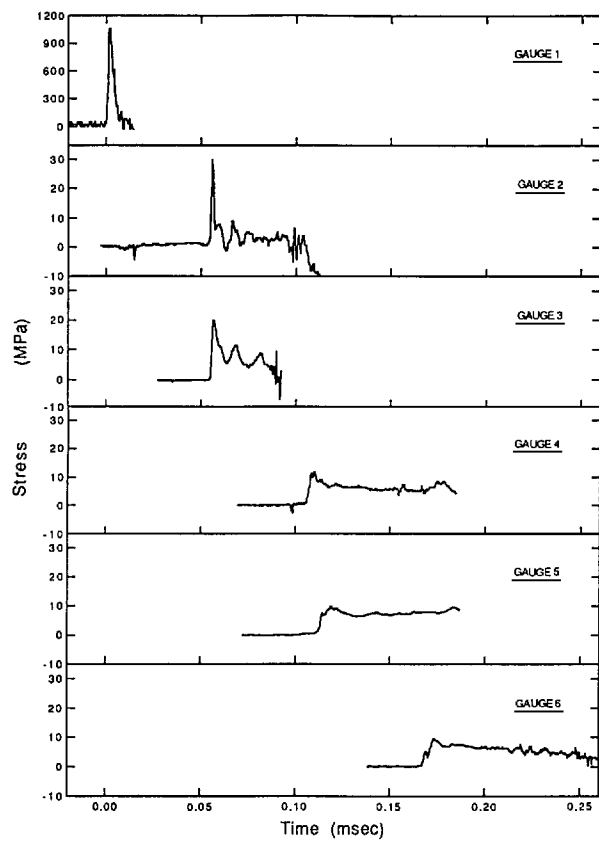

Figure A7. Shot G016.

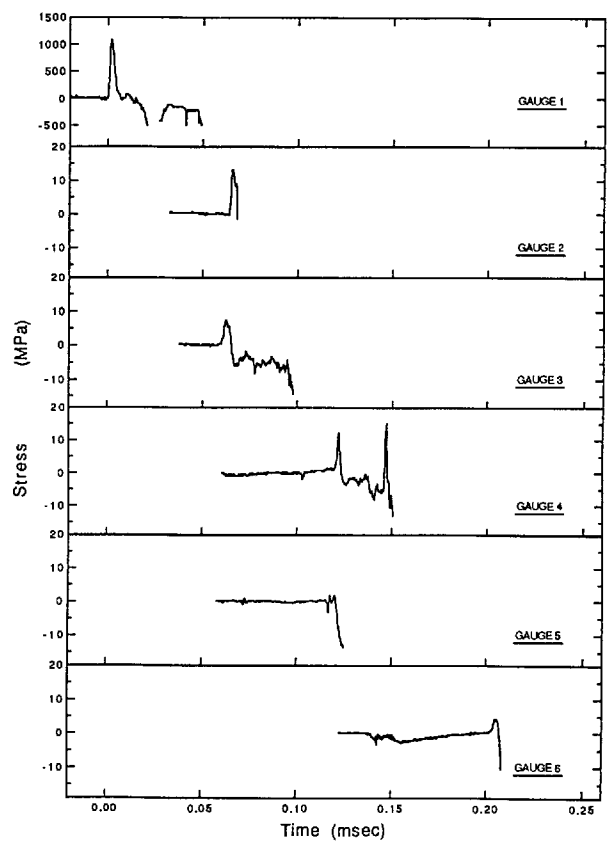

Figure A8. Shot G017.

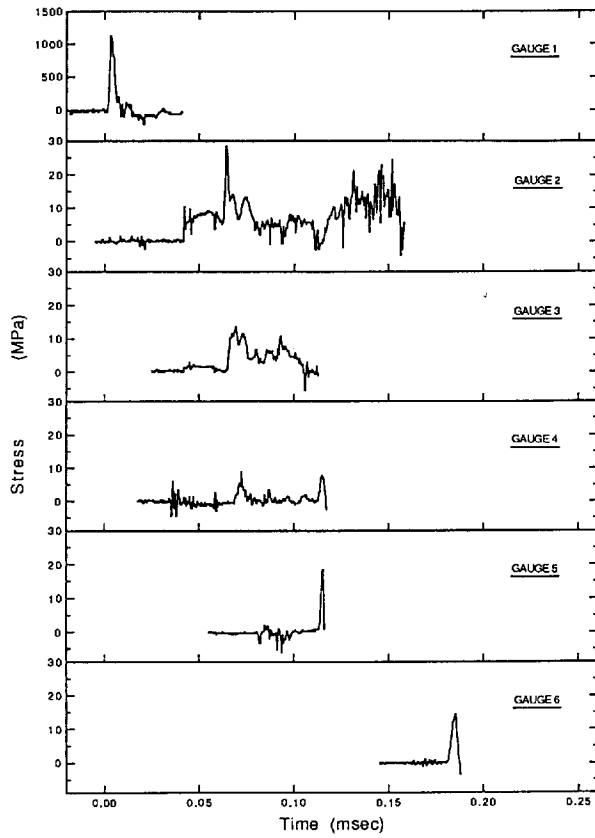

Figure A9. Shot G018.

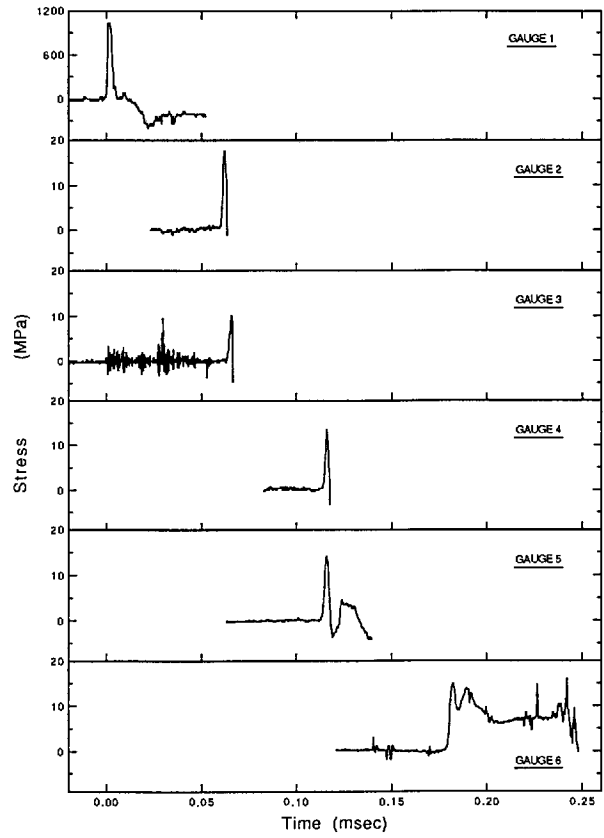

Figure A10. Shot G019.

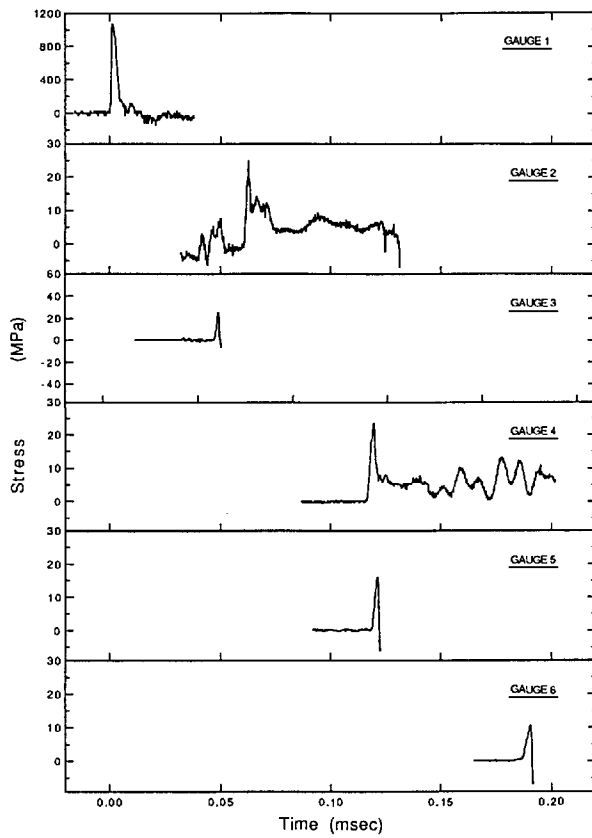

Figure A11. Shot G020.

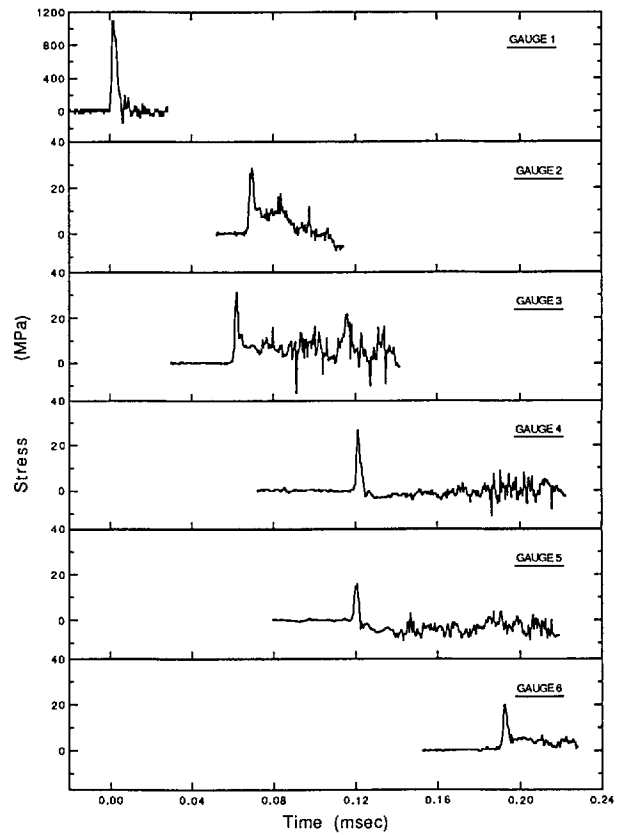

Figure A12. Shot G021.

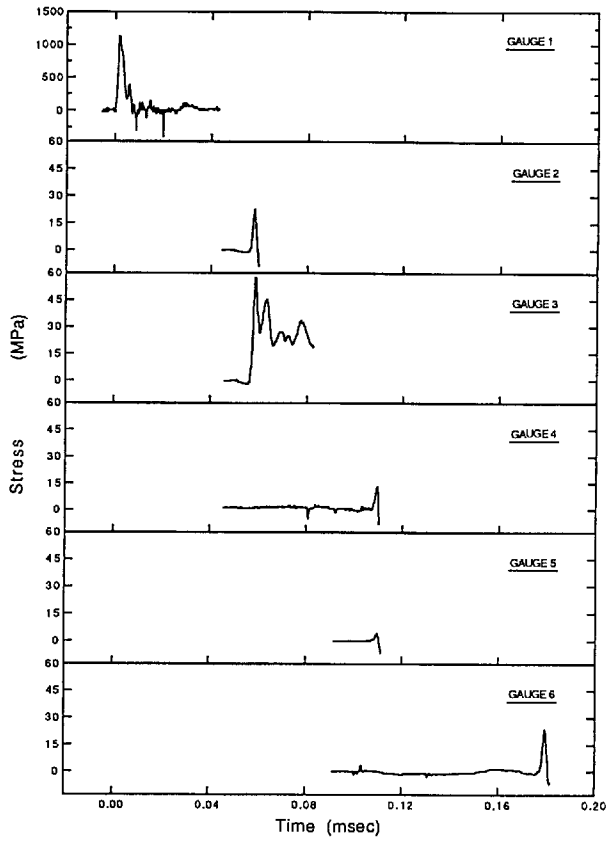

Figure A13. Shot G022.

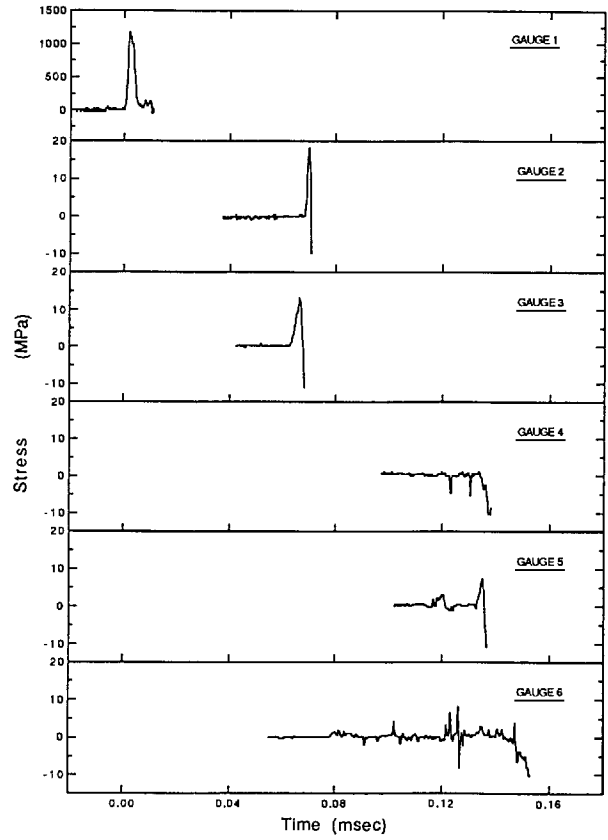

Figure A14. Shot G023.

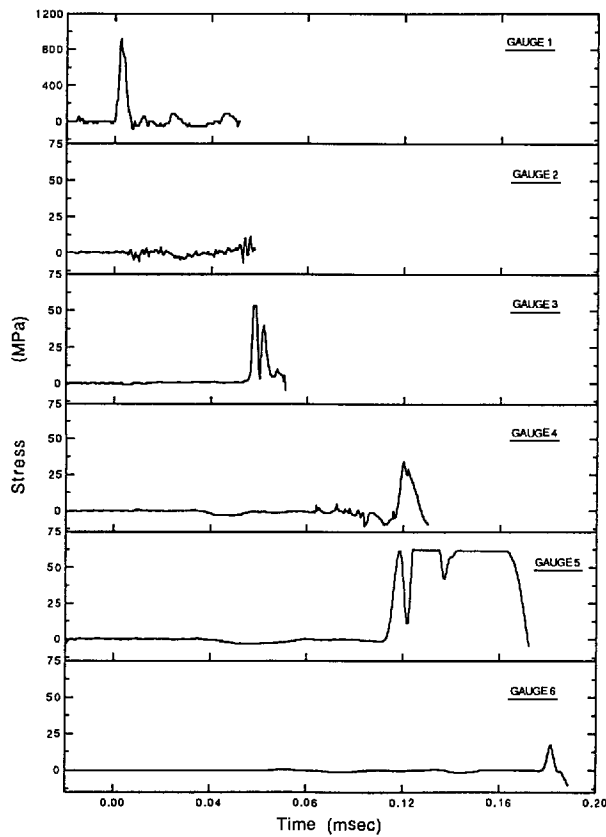

Figure A15. Shot G028.

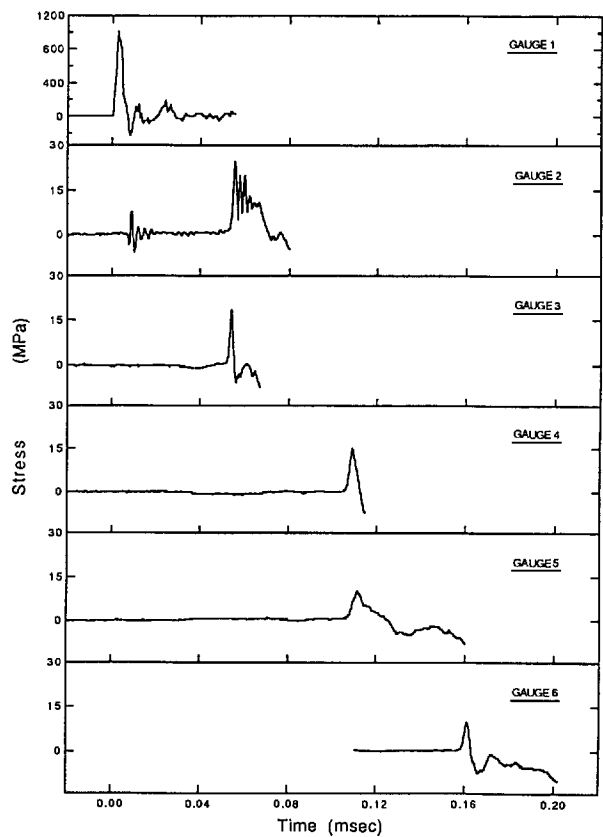

Figure A16. Shot G029.

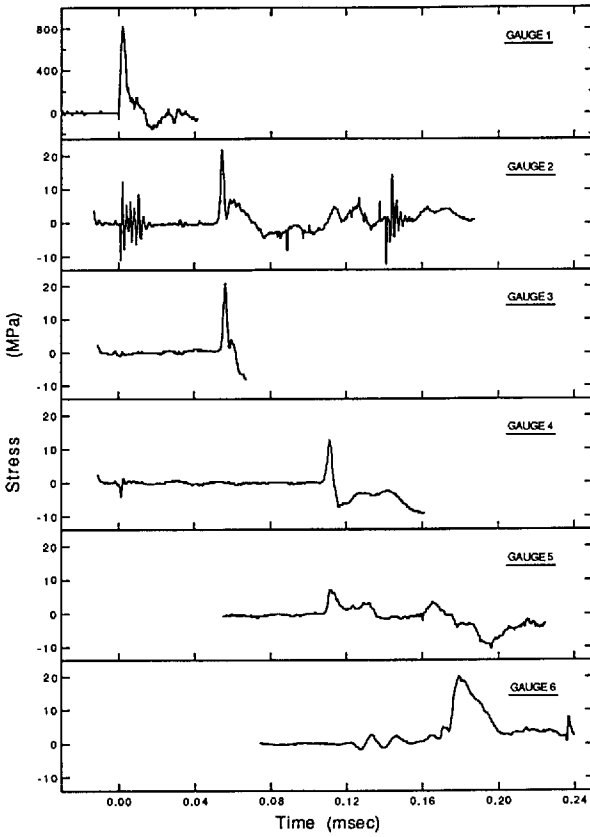

Figure A17. Shot G030.

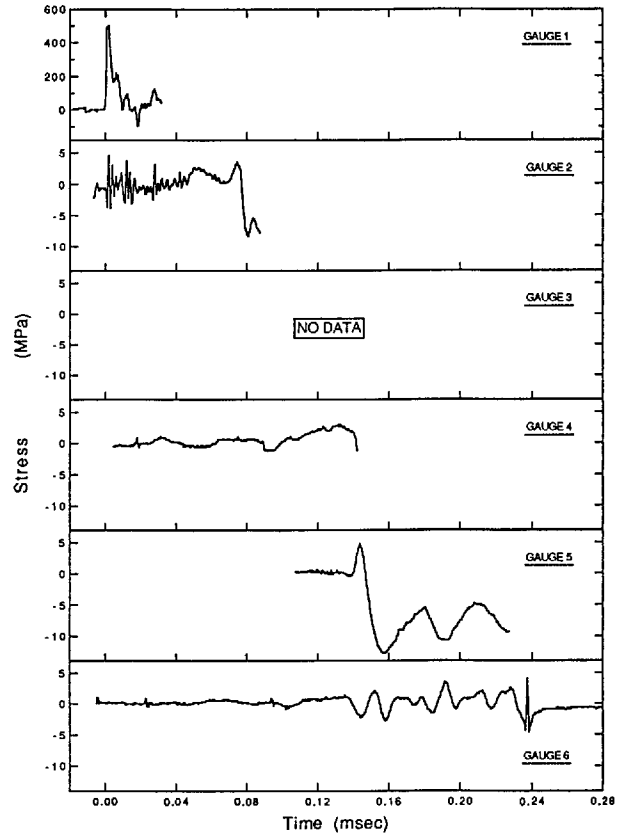

Figure A18. Shot G031.

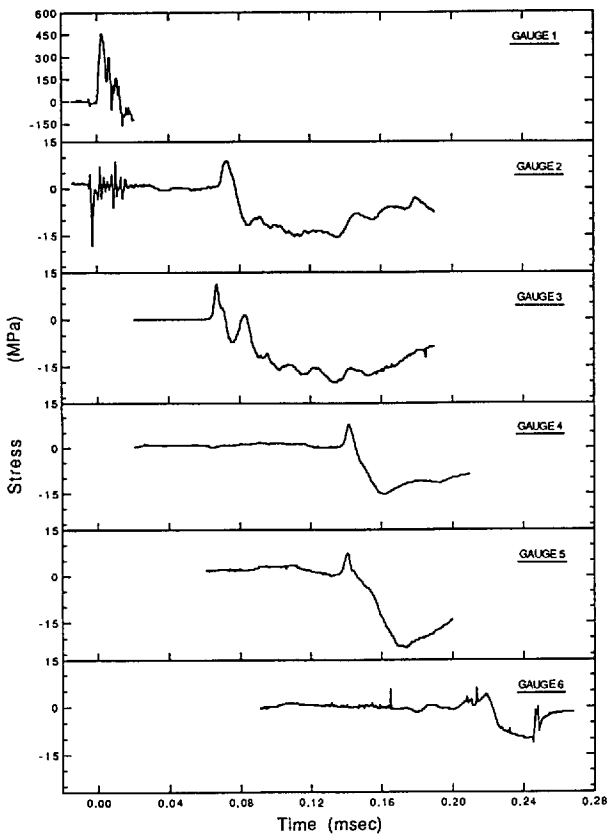

Figure A19. Shot G032.

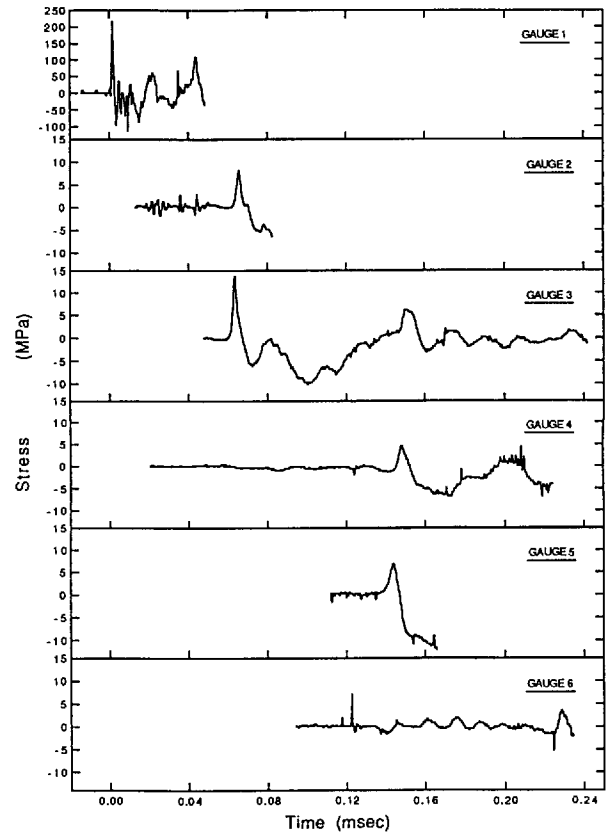

Figure A20. Shot G033.

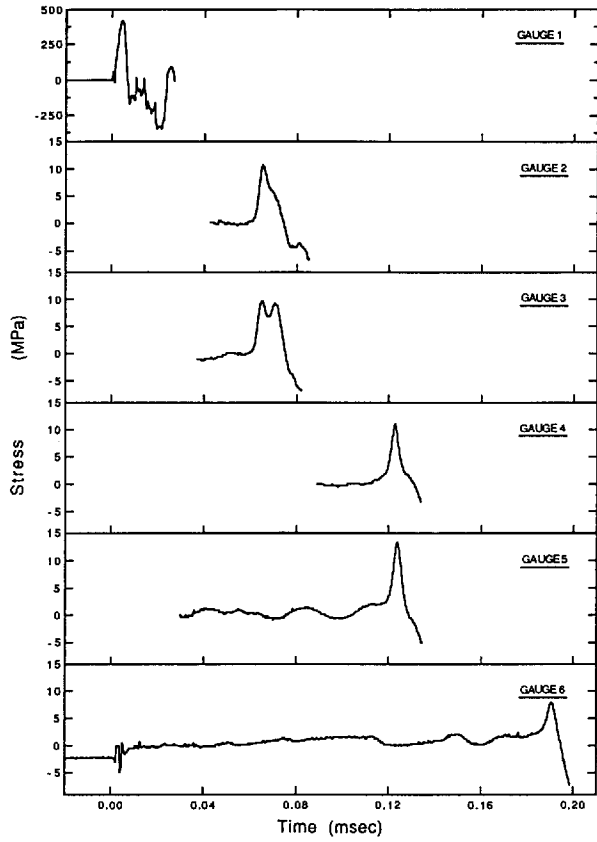

Figure A21. Shot G034.

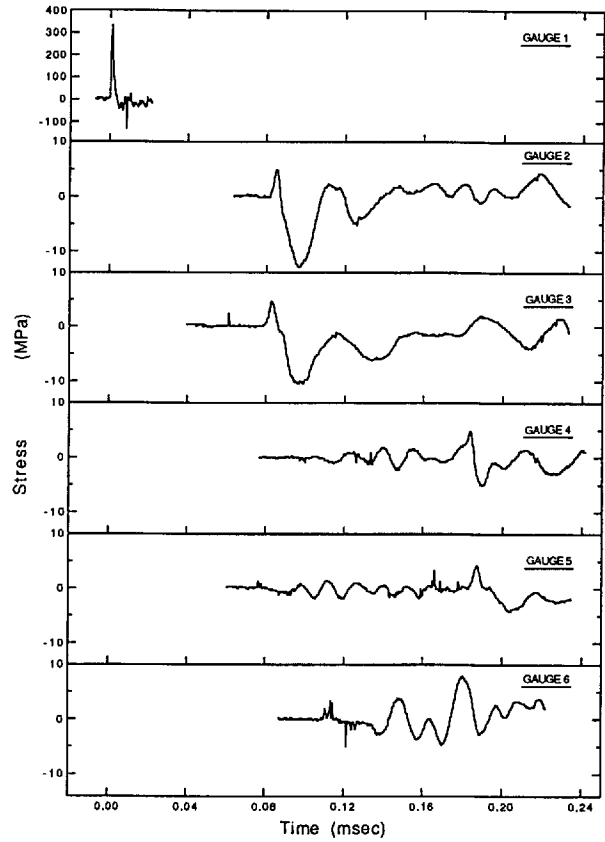

Figure A22. Shot G035.

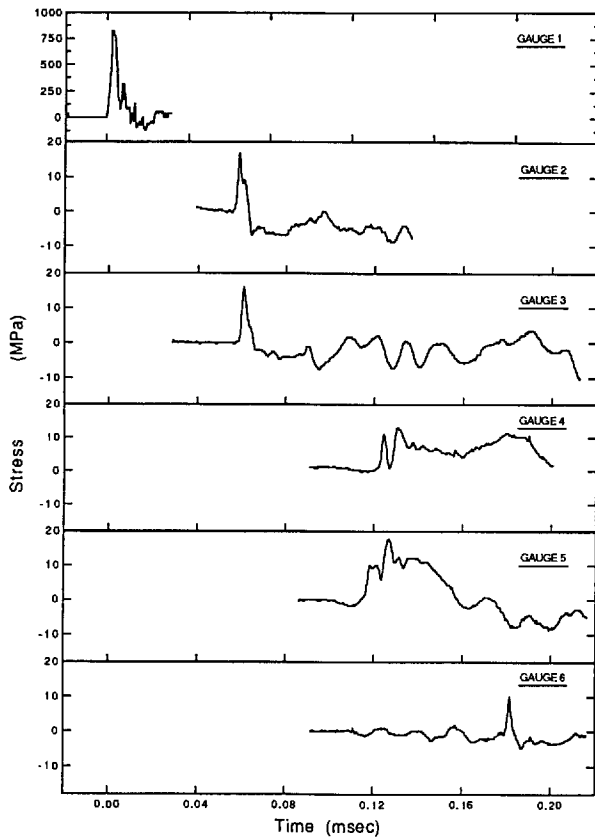

Figure A23. Shot G036.

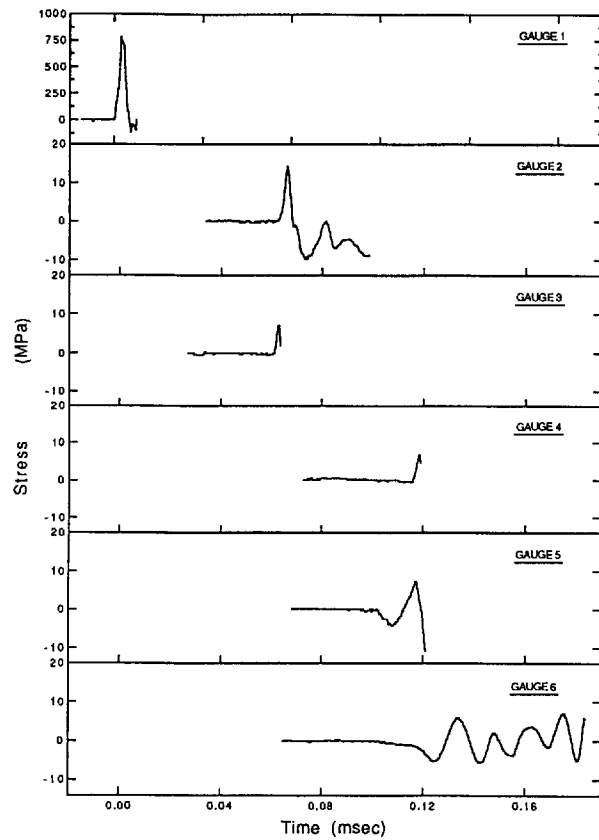

Figure A24. Shot G037.

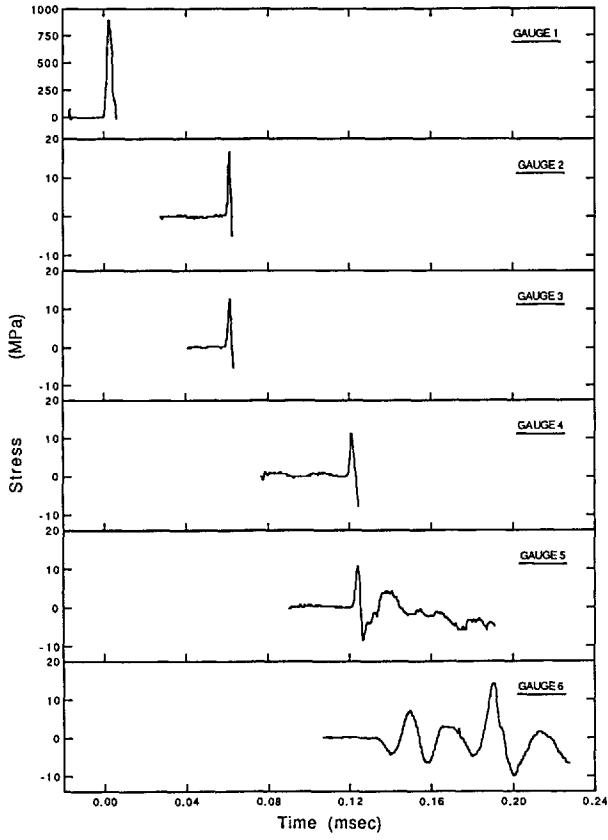

Figure A25. Shot G038.

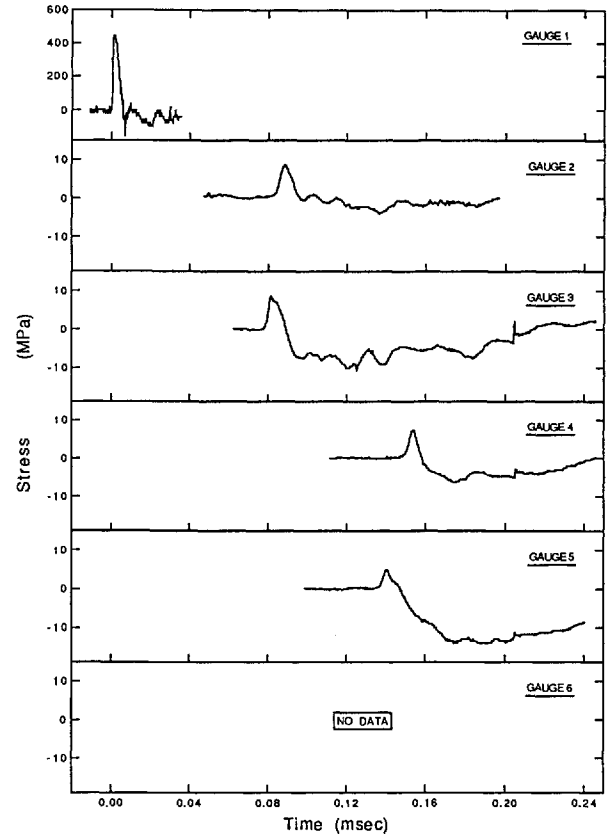

Figure A26. Shot G039.

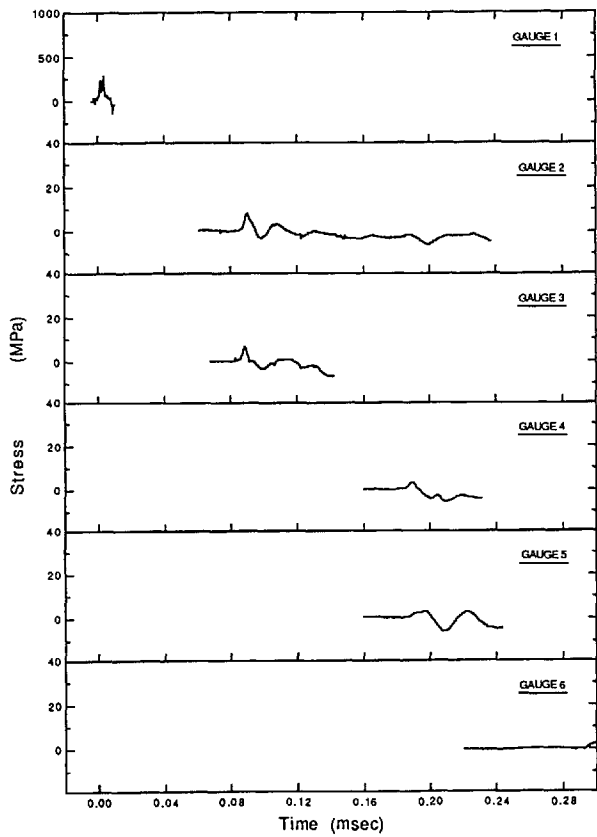

Figure A27. Shot G040.

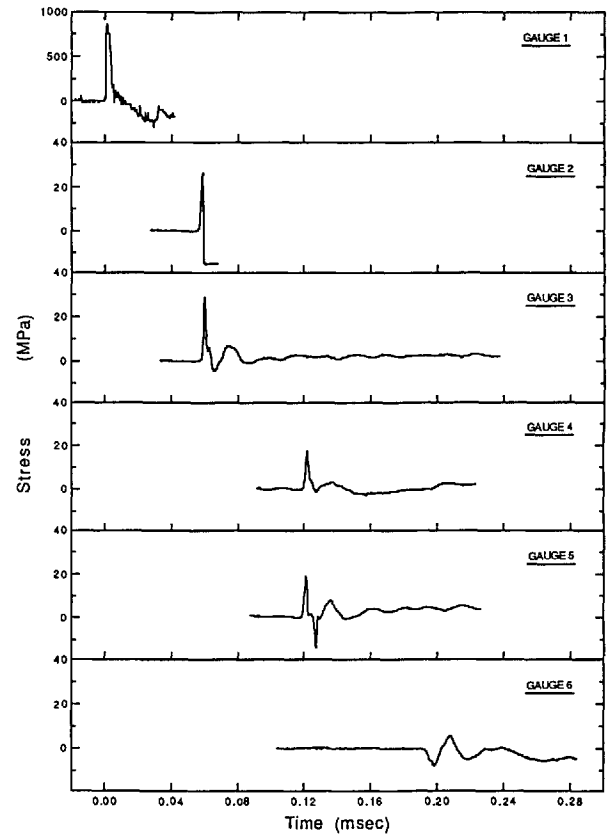

Figure A28. Shot G041.

## APPENDIX B: TABULATED STRESS-TIME DATA

The tabulated stress-time data from all experiments conducted at Los Alamos are presented here. The headings for each gauge indicate the experiment number and gauge number. For example, Gauge 9-2 indicates experiment number G009 and gauge number 2. The location of gauges in a experiment sample can be determined by referring to Figure 5 and Table 2.

Gauge9_2 Time msec	Gauge9_2 Stress MPa	Gauge9_2 Time msec	Gauge9_2 Stress MPa	Gauge9_2 Time msec	Gauge9_2 Stress MPa	Gauge9_2 Time msec	Gauge9_2 Stress MPa	Gauge9_2 Time msec	Gauge9_2 Stress MPa
0.13175	0	0.1425	-0.221	0.15325	0	0.164	3.98	0.17475	3.76
0.132	0	0.14275	0	0.1535	0.221	0.16425	3.1	0.175	3.54
0.13225	0	0.143	0	0.15375	0.221	0.1645	2.88	0.17525	3.54
0.1325	0	0.14325	-0.221	0.154	0.221	0.16475	2.65	0.1755	3.54
0.13275	0	0.1435	-0.221	0.15425	0.221	0.165	2.43	0.17575	3.32
0.133	0	0.14375	-0.221	0.1545	0.221	0.16525	2.65	0.176	3.1
0.13325	0	0.144	-0.221	0.15475	0.221	0.1655	2.65	0.17625	2.88
0.1335	0	0.14425	-0.443	0.155	0.221	0.16575	2.65	0.1765	2.65
0.13375	-0.221	0.1445	-0.221	0.15525	0.221	0.166	3.1	0.17675	2.65
0.134	0	0.14475	0	0.1555	0.221	0.16625	3.54	0.177	2.21
0.13425	0	0.145	0	0.15575	0.221	0.1665	3.76	0.17725	2.21
0.1345	0	0.14525	0	0.156	0.221	0.16675	3.98	0.1775	1.99
0.13475	0	0.1455	0	0.15625	0	0.167	3.98	0.17775	1.99
0.135	0	0.14575	0.221	0.1565	0.221	0.16725	4.42	0.178	1.77
0.13525	0	0.146	0.221	0.15675	0.221	0.1675	4.64	0.17825	1.77
0.1355	0	0.14625	0	0.157	0	0.16775	4.42	0.1785	1.77
0.13575	0	0.1465	0.443	0.15725	0	0.168	4.42	0.17875	1.99
0.136	0	0.14675	0.221	0.1575	0.221	0.16825	4.42	0.179	2.21
0.13625	0	0.147	0.221	0.15775	0.221	0.1685	4.42	0.17925	2.21
0.1365	0	0.14725	0	0.158	0.221	0.16875	4.2	0.1795	2.21
0.13675	0	0.1475	0.221	0.15825	0.443	0.169	3.98	0.17975	2.43
0.137	0	0.14775	0	0.1585	0.885	0.16925	3.76	0.18	2.65
0.13725	0	0.148	0.221	0.15875	1.33	0.1695	3.76	0.18025	2.88
0.1375	0	0.14825	0	0.159	1.55	0.16975	3.32	0.1805	2.88
0.13775	0	0.1485	0.221	0.15925	2.21	0.17	3.32	0.18075	2.88
0.138	0	0.14875	0.221	0.1595	2.88	0.17025	3.32	0.181	3.1
0.13825	0	0.149	0.221	0.15975	3.54	0.1705	3.32	0.18125	3.1
0.1385	-0.221	0.14925	0.221	0.16	4.42	0.17075	3.32	0.1815	3.1
0.13875	-0.221	0.1495	0.221	0.16025	5.08	0.171	3.1	0.18175	3.1
0.139	0	0.14975	0.221	0.1605	5.75	0.17125	3.32	0.182	3.32
0.13925	0	0.15	0.221	0.16075	6.19	0.1715	3.1	0.18225	3.32
0.1395	-0.221	0.15025	0.221	0.161	6.63	0.17175	3.1	0.1825	3.1
0.13975	-0.221	0.1505	0.221	0.16125	7.29	0.172	3.32	0.18275	3.32
0.14	-0.221	0.15075	0.221	0.1615	7.73	0.17225	3.1	0.183	3.32
0.14025	-0.221	0.151	0.221	0.16175	8.61	0.1725	3.32	0.18325	3.32
0.1405	0	0.15125	0.221	0.162	9.49	0.17275	3.32	0.1835	3.32
0.14075	-0.221	0.1515	0.221	0.16225	9.71	0.173	3.32	0.18375	3.32
0.141	0	0.15175	0.221	0.1625	9.71	0.17325	3.54	0.184	3.32
0.14125	0	0.152	0.221	0.16275	9.49	0.1735	3.54	0.18425	3.1
0.1415	0	0.15225	0.221	0.163	8.39	0.17375	3.54	0.1845	2.88
0.14175	0	0.1525	0.221	0.16325	7.95	0.174	3.54	0.18475	3.1
0.142	0	0.15275	0.221	0.1635	7.07	0.17425	3.54	0.185	3.1
0.14225	-0.221	0.153	0	0.16375	5.3	0.1745	3.76	0.18525	3.1



Gauge9_2 Time msec	Gauge9_2 Stress MPa	Gauge9_2 Time msec	Gauge9_2 Stress MPa	Gauge9_2 Time msec	Gauge9_2 Stress MPa	Gauge9_2 Time msec	Gauge9_2 Stress MPa	Gauge9_2 Time msec	Gauge9_2 Stress MPa
0.1855	2.88	0.19625	3.1	0.207	2.65	0.21775	-0.664	0.2285	4.64
0.18575	2.88	0.1965	3.1	0.20725	2.65	0.218	0.885	0.22875	4.42
0.186	2.88	0.19675	3.1	0.2075	2.88	0.21825	1.11	0.229	4.42
0.18625	2.88	0.197	3.1	0.20775	2.88	0.2185	0.885	0.22925	4.2
0.1865	2.88	0.19725	3.1	0.208	3.32	0.21875	0.885	0.2295	4.2
0.18675	2.43	0.1975	3.1	0.20825	2.88	0.219	0.885	0.22975	4.2
0.187	2.43	0.19775	3.32	0.2085	2.65	0.21925	0.885	0.23	3.98
0.18725	2.21	0.198	3.32	0.20875	2.65	0.2195	1.11	0.23025	3.76
0.1875	1.99	0.19825	3.32	0.209	2.65	0.21975	1.55	0.2305	3.76
0.18775	1.99	0.1985	3.54	0.20925	2.43	0.22	1.33	0.23075	3.54
0.188	1.99	0.19875	3.54	0.2095	1.33	0.22025	1.55	0.231	3.54
0.18825	1.99	0.199	3.32	0.20975	2.43	0.2205	1.99	0.23125	3.1
0.1885	1.99	0.19925	3.32	0.21	1.99	0.22075	2.21	0.2315	3.1
0.18875	1.99	0.1995	3.1	0.21025	2.88	0.221	2.88	0.23175	2.88
0.189	1.99	0.19975	3.1	0.2105	2.21	0.22125	3.1	0.232	2.88
0.18925	1.99	0.2	3.32	0.21075	2.65	0.2215	3.76	0.23225	2.65
0.1895	1.77	0.20025	2.88	0.211	2.21	0.22175	3.98	0.2325	2.43
0.18975	1.77	0.2005	2.88	0.21125	2.65	0.222	4.64	0.23275	2.43
0.19	1.77	0.20075	2.88	0.2115	2.43	0.22225	4.86	0.233	2.21
0.19025	1.55	0.201	2.65	0.21175	2.43	0.2225	5.3	0.23325	1.99
0.1905	1.55	0.20125	2.43	0.212	2.43	0.22275	5.75	0.2335	1.55
0.19075	1.33	0.2015	2.43	0.21225	2.88	0.223	5.75	0.23375	1.55
0.191	1.33	0.20175	2.43	0.2125	2.43	0.22325	5.97	0.234	1.33
0.19125	1.11	0.202	2.21	0.21275	2.43	0.2235	6.41	0.23425	0.885
0.1915	1.33	0.20225	2.43	0.213	1.99	0.22375	6.85	0.2345	0.664
0.19175	1.33	0.2025	2.21	0.21325	2.43	0.224	6.85	0.23475	0.664
0.192	1.33	0.20275	2.88	0.2135	2.43	0.22425	6.85	0.235	0.664
0.19225	1.33	0.203	2.65	0.21375	2.43	0.2245	6.63	0.23525	0.443
0.1925	1.55	0.20325	2.43	0.214	2.65	0.22475	6.63	0.2355	0.443
0.19275	1.77	0.2035	2.88	0.21425	2.65	0.225	6.63	0.23575	0.221
0.193	1.77	0.20375	2.21	0.2145	2.43	0.22525	6.41	0.236	0.221
0.19325	1.99	0.204	2.43	0.21475	2.65	0.2255	6.19	0.23625	0.221
0.1935	1.99	0.20425	2.43	0.215	3.1	0.22575	5.97	0.2365	-0.221
0.19375	2.21	0.2045	2.43	0.21525	4.64	0.226	5.97	0.23675	0
0.194	2.43	0.20475	2.43	0.2155	3.98	0.22625	5.53	0.237	-0.221
0.19425	2.43	0.205	2.65	0.21575	2.88	0.2265	5.53	0.23725	-0.221
0.1945	2.65	0.20525	2.65	0.216	2.43	0.22675	5.3	0.2375	-0.443
0.19475	2.88	0.2055	2.65	0.21625	2.65	0.227	5.3	0.23775	-0.664
0.195	2.88	0.20575	2.65	0.2165	2.21	0.22725	5.08	0.238	-0.443
0.19525	2.88	0.206	2.65	0.21675	1.99	0.2275	4.86	0.23825	-0.664
0.1955	3.1	0.20625	2.65	0.217	1.55	0.22775	5.08	0.2385	-0.664
0.19575	3.1	0.2065	2.65	0.21725	1.55	0.228	4.86	0.23875	-0.664
0.196	3.32	0.20675	2.65	0.2175	0.443	0.22825	4.64	0.239	-0.886

Gauge9_2 Time msec	Gauge9_2 Stress MPa	Gauge9_2 Time msec	Gauge9_2 Stress MPa	Gauge9_2 Time msec	Gauge9_2 Stress MPa	Gauge9_2 Time msec	Gauge9_2 Stress MPa	Gauge9_3 Time msec	Gauge9_3 Stress MPa
0.23925	-0.886	0.25	-0.664	0.26075	-1.11	0.2715	-3.32	0.07	1.96
0.2395	-0.886	0.25025	-0.664	0.261	-1.11	0.27175	-3.32	0.0705	2.07
0.23975	-0.886	0.2505	-0.664	0.26125	-1.33	0.272	-3.32	0.071	1.96
0.24	-0.886	0.25075	-0.664	0.2615	-1.33	0.27225	-3.32	0.0715	1.96
0.24025	-0.886	0.251	-0.443	0.26175	-1.33	0.2725	-3.32	0.072	1.96
0.2405	-0.886	0.25125	-0.443	0.262	-1.11	0.27275	-3.32	0.0725	1.96
0.24075	-0.664	0.2515	-0.443	0.26225	-1.11	0.273	-3.77	0.073	2.07
0.241	-0.886	0.25175	-0.443	0.2625	-1.33	0.27325	-3.55	0.0735	2.07
0.24125	-0.886	0.252	-0.443	0.26275	-1.11	0.2735	-3.55	0.074	2.18
0.2415	-1.11	0.25225	-0.443	0.263	-1.11	0.27375	-3.55	0.0745	1.86
0.24175	-0.886	0.2525	-0.443	0.26325	-1.33	0.274	-3.77	0.075	2.07
0.242	-0.886	0.25275	-0.443	0.2635	-1.33	0.27425	-3.77	0.0755	1.96
0.24225	-0.886	0.253	-0.443	0.26375	-1.11	0.2745	-3.77	0.076	1.96
0.2425	-0.886	0.25325	-0.664	0.264	-1.33	0.27475	-3.55	0.0765	2.07
0.24275	-0.886	0.2535	-0.443	0.26425	-1.33	0.275	-3.77	0.077	2.07
0.243	-0.886	0.25375	-0.443	0.2645	-1.33	0.27525	-3.77	0.0775	1.96
0.24325	-0.886	0.254	-0.664	0.26475	-1.33	0.2755	-3.77	0.078	1.96
0.2435	-0.886	0.25425	-0.664	0.265	-1.33	0.27575	-3.77	0.0785	1.96
0.24375	-0.886	0.2545	-0.664	0.26525	-1.33	0.276	-3.77	0.079	2.07
0.244	-0.886	0.25475	-0.664	0.2655	-1.55	0.27625	-3.55	0.0795	2.07
0.24425	-0.886	0.255	-0.664	0.26575	-1.55	0.2765	-3.77	0.08	1.96
0.2445	-0.664	0.25525	-0.664	0.266	-1.55	0.27675	-3.99	0.0805	2.07
0.24475	-0.664	0.2555	-0.664	0.26625	-1.77	0.277	-3.99	0.081	2.07
0.245	-0.664	0.25575	-0.664	0.2665	-1.77	0.27725	-3.77	0.0815	1.96
0.24525	-0.664	0.256	-0.664	0.26675	-1.77	0.2775	-3.99	0.082	1.96
0.2455	-0.664	0.25625	-0.664	0.267	-1.99	0.27775	-3.99	0.0825	1.96
0.24575	-0.664	0.2565	-0.886	0.26725	-1.99	0.278	-3.99	0.083	2.18
0.246	-0.664	0.25675	-0.886	0.2675	-1.99	0.27825	-3.99	0.0835	2.07
0.24625	-0.664	0.257	-0.886	0.26775	-1.99	0.2785	-3.99	0.084	2.07
0.2465	-0.443	0.25725	-0.886	0.268	-2.22	0.27875	-3.99	0.0845	2.07
0.24675	-0.664	0.2575	-0.886	0.26825	-2.44	0.279	-3.99	0.085	2.07
0.247	-0.443	0.25775	-0.886	0.2685	-2.66			0.0855	2.07
0.24725	-0.443	0.258	-0.886	0.26875	-2.44			0.086	2.18
0.2475	-0.443	0.25825	-0.886	0.269	-2.66			0.0865	2.18
0.24775	-0.443	0.2585	-0.886	0.26925	-2.66			0.087	1.96
0.248	-0.664	0.25875	-0.886	0.2695	-2.44			0.0875	1.96
0.24825	-0.443	0.259	-0.886	0.26975	-2.44			0.088	1.96
0.2485	-0.443	0.25925	-0.886	0.27	-2.66			0.0885	2.07
0.24875	-0.664	0.2595	-0.886	0.27025	-2.88			0.089	2.07
0.249	-0.443	0.25975	-0.886	0.2705	-3.1			0.0895	2.18
0.24925	-0.664	0.26	-1.11	0.27075	-3.1			0.09	2.18
0.2495	-0.664	0.26025	-1.11	0.271	-3.1			0.0905	2.07
0.24975	-0.664	0.2605	-1.11	0.27125	-3.32			0.091	2.07

Gauge9_3 Time msec	Gauge9_3 Stress MPa	Gauge9_3 Time msec	Gauge9_3 Stress MPa	Gauge9_3 Time msec	Gauge9_3 Stress MPa	Gauge9_3 Time msec	Gauge9_3 Stress MPa	Gauge9_3 Time msec	Gauge9_3 Stress MPa
0.0915	2.07	0.113	-0.218	0.1345	-0.109	0.156	0.437	0.1775	-6.89
0.092	1.86	0.1135	-0.218	0.135	-0.218	0.1565	0.437	0.178	-6.78
0.0925	1.86	0.114	-0.218	0.1355	-0.218	0.157	0.437	0.1785	-6.89
0.093	2.07	0.1145	-0.218	0.136	0	0.1575	0.328	0.179	-7
0.0935	2.07	0.115	-0.109	0.1365	0	0.158	0.328	0.1795	-6.89
0.094	2.18	0.1155	0	0.137	-0.109	0.1585	0.437	0.18	-6.67
0.0945	2.18	0.116	0	0.1375	-0.109	0.159	0.437	0.1805	-6.24
0.095	2.18	0.1165	0	0.138	-0.218	0.1595	0.546	0.181	-5.8
0.0955	2.18	0.117	0	0.1385	-0.109	0.16	0.655	0.1815	-5.25
0.096	2.18	0.1175	-0.109	0.139	0	0.1605	0.655	0.182	-5.14
0.0965	1.96	0.118	0	0.1395	0	0.161	0.655	0.1825	-5.03
0.097	-0.109	0.1185	0	0.14	-0.109	0.1615	0.983	0.183	-5.03
0.0975	-0.218	0.119	0	0.1405	0	0.162	1.09	0.1835	-5.25
0.098	-0.218	0.1195	0	0.141	0.109	0.1625	1.53	0.184	-5.36
0.0985	2.29	0.12	0	0.1415	0.218	0.163	2.07	0.1845	-5.47
0.099	2.29	0.1205	0.109	0.142	0.109	0.1635	3.38	0.356	-5.8
0.0995	2.18	0.121	0	0.1425	0.109	0.164	5.56	0.3565	-6.13
0.1	2.18	0.1215	-0.109	0.143	0.109	0.1645	6.43	0.357	-6.35
0.1005	2.18	0.122	-0.109	0.1435	0.109	0.165	8.5	0.3575	-6.57
0.101	2.29	0.1225	0	0.144	0.109	0.1655	8.82	0.358	-6.67
0.1015	2.18	0.123	0	0.1445	-0.437	0.166	5.34	0.3585	-6.89
0.102	1.53	0.1235	0	0.145	0.437	0.1665	0.437		
0.1025	-0.328	0.124	0	0.1455	0.109	0.167	-1.53		
0.103	-0.109	0.1245	0.109	0.146	0.218	0.1675	-1.53		
0.1035	-0.218	0.125	0.109	0.1465	0.218	0.168	-1.86		
0.104	-0.109	0.1255	0.109	0.147	0.218	0.1685	-2.51		
0.1045	-0.218	0.126	-0.109	0.1475	0.437	0.169	-2.84		
0.105	-0.109	0.1265	0	0.148	0.437	0.1695	-3.28		
0.1055	-0.109	0.127	-0.109	0.1485	0.437	0.17	-3.61		
0.106	-0.218	0.1275	-0.109	0.149	0.437	0.1705	-4.05		
0.1065	1.64	0.128	-0.109	0.1495	0.218	0.171	-4.26		
0.107	2.07	0.1285	-0.109	0.15	0.328	0.1715	-4.7		
0.1075	2.18	0.129	-0.109	0.1505	0.437	0.172	-4.48		
0.108	2.18	0.1295	-0.218	0.151	0.328	0.1725	-4.59		
0.1085	2.07	0.13	-0.109	0.1515	0.328	0.173	-4.81		
0.109	0.874	0.1305	-0.328	0.152	0.328	0.1735	-4.48		
0.1095	-0.218	0.131	-0.218	0.1525	0.328	0.174	-4.7		
0.11	-0.328	0.1315	-0.109	0.153	0.437	0.1745	-4.92		
0.1105	-0.218	0.132	-0.109	0.1535	0.437	0.175	-5.14		
0.111	-0.218	0.1325	0.109	0.154	0.437	0.1755	-5.36		
0.1115	-0.109	0.133	-0.218	0.1545	0.328	0.176	-5.58		
0.112	-0.109	0.1335	-0.109	0.155	0.437	0.1765	-6.13		
0.1125	-0.218	0.134	-0.109	0.1555	0.437	0.177	-6.67		

Gauge9_5 Time msec	Gauge9_5 Stress MPa	Gauge9_5 Time msec	Gauge9_5 Stress MPa	Gauge9_5 Time msec	Gauge9_5 Stress MPa	Gauge9_5 Time msec	Gauge9_5 Stress MPa	Gauge9_5 Time msec	Gauge9_5 Stress MPa
0.17	-0.437	0.1915	-0.218	0.213	0.109	0.2345	6.54	0.256	3.27
0.1705	-0.328	0.192	-0.218	0.2135	0.109	0.235	6.65	0.2565	3.27
0.171	-0.218	0.1925	-0.109	0.214	0.109	0.2355	6.54	0.257	3.16
0.1715	-0.328	0.193	-0.328	0.2145	0	0.236	6.65	0.2575	3.27
0.172	-0.109	0.1935	-0.109	0.215	0.109	0.2365	6.43	0.258	3.38
0.1725	-0.437	0.194	-0.109	0.2155	0.109	0.237	6.32	0.2585	3.49
0.173	-0.218	0.1945	-0.109	0.216	0.328	0.2375	6.11	0.259	3.71
0.1735	-0.328	0.195	-0.218	0.2165	0.437	0.238	6	0.2595	3.71
0.174	-0.328	0.1955	-0.218	0.217	0.655	0.2385	5.67	0.26	3.49
0.1745	-0.328	0.196	0	0.2175	0.874	0.239	5.45	0.2605	3.71
0.175	-0.218	0.1965	-0.109	0.218	1.75	0.2395	5.23	0.261	3.71
0.1755	-0.218	0.197	-0.218	0.2185	2.84	0.24	4.91	0.2615	3.71
0.176	-0.109	0.1975	-0.109	0.219	4.25	0.2405	4.8	0.262	3.93
0.1765	-0.218	0.198	-0.218	0.2195	5.23	0.241	4.58	0.2625	4.04
0.177	-0.218	0.1985	-0.109	0.22	6	0.2415	4.47	0.263	4.04
0.1775	-0.218	0.199	-0.109	0.2205	6.43	0.242	4.36	0.2635	4.04
0.178	-0.328	0.1995	0	0.221	7.19	0.2425	4.36	0.264	3.93
0.1785	-0.109	0.2	-0.109	0.2215	7.3	0.243	4.36	0.2645	4.04
0.179	-0.328	0.2005	-0.109	0.222	7.08	0.2435	4.47	0.265	4.15
0.1795	-0.218	0.201	-0.109	0.2225	7.08	0.244	4.47	0.2655	4.04
0.18	-0.218	0.2015	-0.109	0.223	7.85	0.2445	4.47	0.266	4.15
0.1805	-0.218	0.202	0	0.2235	8.61	0.245	4.47	0.2665	4.15
0.181	-0.218	0.2025	0	0.224	9.04	0.2455	4.47	0.267	4.36
0.1815	-0.218	0.203	0	0.2245	9.26	0.246	4.36	0.2675	4.36
0.182	-0.218	0.2035	0	0.225	9.37	0.2465	4.25	0.268	4.47
0.1825	-0.218	0.204	0	0.2255	8.61	0.247	4.25	0.2685	4.25
0.183	-0.109	0.2045	0	0.226	8.28	0.2475	4.25	0.269	4.15
0.1835	-0.218	0.205	0	0.2265	8.28	0.248	4.36	0.2695	3.93
0.184	-0.218	0.2055	0	0.227	8.06	0.2485	4.15	0.27	3.93
0.1845	-0.109	0.206	0	0.2275	8.06	0.249	3.93	0.2705	3.82
0.185	-0.218	0.2065	0	0.228	7.95	0.2495	4.04	0.271	3.82
0.1855	-0.218	0.207	-0.109	0.2285	7.74	0.25	3.93	0.2715	3.6
0.186	-0.109	0.2075	0.109	0.229	7.85	0.2505	4.15	0.272	3.6
0.1865	-0.218	0.208	0	0.2295	8.17	0.251	3.71	0.2725	3.6
0.187	-0.218	0.2085	0	0.23	7.95	0.2515	3.71	0.273	3.38
0.1875	-0.218	0.209	0.109	0.2305	7.85	0.252	3.71	0.2735	3.6
0.188	-0.218	0.2095	0.218	0.231	7.74	0.2525	3.71	0.274	3.38
0.1885	-0.218	0.21	0.655	0.2315	7.52	0.253	3.71	0.2745	3.49
0.189	-0.218	0.2105	0.328	0.232	7.41	0.2535	3.71	0.275	3.38
0.1895	-0.218	0.211	0.109	0.2325	7.19	0.254	3.71	0.2755	3.06
0.19	-0.218	0.2115	-0.109	0.233	6.87	0.2545	3.71	0.276	3.16
0.1905	-0.218	0.212	-0.109	0.2335	6.87	0.255	3.49	0.2765	2.95
0.191	-0.218	0.2125	-0.109	0.234	6.54	0.2555	3.38	0.277	2.95

Gauge9_5 Time msec	Gauge9_5 Stress MPa	Gauge9_5 Time msec	Gauge9_5 Stress MPa	Gauge9_6 Time msec	Gauge9_6 Stress MPa	Gauge9_6 Time msec	Gauge9_6 Stress MPa	Gauge9_6 Time msec	Gauge9_6 Stress MPa
0.2775	2.84	0.299	3.27	0.2445	0	0.266	0.65	0.2875	4.11
0.278	2.73	0.2995	3.38	0.245	-0.108	0.2665	0.975	0.288	4.11
0.2785	2.95			0.2455	-0.108	0.267	1.73	0.2885	4.22
0.279	3.06			0.246	-0.108	0.2675	2.49	0.289	4.22
0.2795	3.06			0.2465	0.108	0.268	3.47	0.2895	4.11
0.28	3.16			0.247	0	0.2685	4.44	0.29	4.01
0.2805	3.38			0.2475	0	0.269	5.3	0.2905	3.68
0.281	3.38			0.248	-0.108	0.2695	6.17	0.291	3.79
0.2815	3.49			0.2485	-0.108	0.27	6.71	0.2915	3.79
0.282	3.82			0.249	0	0.2705	6.82	0.292	3.79
0.2825	3.93			0.2495	0	0.271	6.38	0.2925	3.68
0.283	4.04			0.25	0	0.2715	5.74	0.293	3.57
0.2835	4.25			0.2505	0	0.272	4.76	0.2935	3.68
0.284	4.36			0.251	0.108	0.2725	3.68	0.294	3.68
0.2845	4.58			0.2515	0.108	0.273	3.57	0.2945	3.79
0.285	4.91			0.252	0	0.2735	3.79	0.295	3.68
0.2855	5.13			0.2525	0	0.274	3.9	0.2955	3.79
0.286	5.34			0.253	0	0.2745	3.68	0.296	3.79
0.2865	5.34			0.2535	0.108	0.275	3.57	0.2965	3.79
0.287	5.56			0.254	0.108	0.2755	3.47	0.297	3.9
0.2875	5.56			0.2545	0.108	0.276	3.57	0.2975	3.79
0.288	5.67			0.255	0	0.2765	3.36	0.298	3.79
0.2885	5.67			0.2555	0.108	0.277	3.25	0.2985	3.68
0.289	5.78			0.256	0.108	0.2775	3.36	0.299	3.79
0.2895	5.78			0.2565	0.108	0.278	3.47	0.2995	3.57
0.29	5.78			0.257	0.108	0.2785	3.68	0.3	3.57
0.2905	5.56			0.2575	0	0.279	3.47	0.3005	3.79
0.291	5.23			0.258	0.108	0.2795	3.47	0.301	3.68
0.2915	5.13			0.2585	0.108	0.28	3.68	0.3015	3.79
0.292	5.02			0.259	0.108	0.2805	3.79	0.302	3.9
0.2925	4.69			0.2595	0.108	0.281	4.01	0.3025	3.68
0.293	4.69			0.26	0.108	0.2815	4.33	0.303	3.79
0.2935	4.25			0.2605	0.108	0.282	4.44		
0.294	4.25			0.261	0.108	0.2825	4.55		
0.2945	4.04			0.2615	0.108	0.283	4.65		
0.295	3.82			0.262	0.108	0.2835	4.76		
0.2955	3.6			0.2625	0.217	0.284	4.76		
0.296	3.49			0.263	0.217	0.2845	4.65		
0.2965	3.6			0.2635	0.108	0.285	4.55		
0.297	3.49			0.264	0.217	0.2855	4.65		
0.2975	3.38			0.2645	0.325	0.286	4.55		
0.298	3.38			0.265	0.325	0.2865	4.22		
0.2985	3.38			0.2655	0.434	0.287	4.22		

Gauge10_1 Time msec	Gauge10_1 Stress MPa	Gauge10_1 Time msec	Gauge10_1 Stress MPa	Gauge10_1 Time msec	Gauge10_1 Stress MPa	Gauge10_2 Time msec	Gauge10_2 Stress MPa	Gauge10_2 Time msec	Gauge10_2 Stress MPa
-0.00675	0	0.004	-23.66	0.01475	5.22	0.059	0.479	0.06975	12.28
-0.0065	0	0.00425	-21.02	0.015	15.61	0.05925	-0.377	0.07	11.95
-0.00625	0	0.0045	-26.31	0.01525	28.52	0.0595	-0.351	0.07025	11.99
-0.006	0	0.00475	-2.61	0.0155	38.78	0.05975	-0.207	0.0705	11.48
-0.00575	0	0.005	10.42	0.01575	47.48	0.06	0.1	0.07075	11.65
-0.0055	0	0.00525	25.94	0.016	52.89	0.06025	0.002	0.071	11.62
-0.00525	0	0.0055	28.52	0.01625	58.19	0.0605	0.003	0.07125	11.82
-0.005	0	0.00575	25.94	0.0165	68.47	0.06075	-0.425	0.0715	11.61
-0.00475	2.61	0.006	20.78	0.01675	63.38	0.061	0.058	0.07175	11.69
-0.0045	0	0.00625	31.09	0.017	58.19	0.06125	0.163	0.072	11.15
-0.00425	2.61	0.0065	15.61	0.01725	52.89	0.0615	1.07	0.07225	10.72
-0.004	2.61	0.00675	31.09	0.0175	43.89	0.06175	0.825	0.0725	10.39
-0.00375	2.61	0.007	97.09	0.01775	38.78	0.062	0.918	0.07275	9.98
-0.0035	2.61	0.00725	114.59	0.018	38.78	0.06225	0.348	0.073	10.34
-0.00325	2.61	0.0075	87.9	0.01825	36.22	0.0625	1.22	0.07325	9.78
-0.003	2.61	0.00775	127.02	0.0185	38.78	0.06275	3.11	0.0735	11.23
-0.00275	0	0.008	135.02	0.01875	36.22	0.063	6.85	0.07375	11.83
-0.0025	-2.61	0.00825	157.88	0.019	33.66	0.06325	11.16	0.074	7.07
-0.00225	2.61	0.0085	165.19	0.01925	33.66	0.0635	15.01	0.07425	8.96
-0.002	2.61	0.00875	154.18	0.0195	33.66	0.06375	17.62	0.0745	8.54
-0.00175	2.61	0.009	146.65	0.01975	33.66	0.064	26.33	0.07475	9.37
-0.0015	0	0.00925	131.05	0.02	28.52	0.06425	21.73	0.075	8.93
-0.00125	2.61	0.0095	131.05	0.02025	15.61	0.0645	22.34	0.07525	8.96
-0.001	2.61	0.00975	122.94	0.0205	7.82	0.06475	20.89	0.0755	7.95
-0.00075	2.61	0.01	127.02	0.02075	2.61	0.065	20.51	0.07575	7.56
-0.0005	2.61	0.01025	127.02	0.021	2.61	0.06525	17.91	0.076	7.13
-0.00025	0	0.0105	127.02	0.02125	0	0.0655	16.08	0.07625	7.64
0	2.61	0.01075	127.02	0.0215	-5.23	0.06575	12.89	0.0765	8.5
0.00025	31.09	0.011	83.17	0.02175	0	0.066	11.35	0.07675	9.45
0.0005	189.86	0.01125	47.48	0.022	10.42	0.06625	9.74	0.077	10.14
0.00075	281.61	0.0115	38.78	0.02225	13.02	0.0665	9.76	0.07725	10.1
0.001	336.55	0.01175	31.09	0.0225	20.78	0.06675	9.63	0.0775	9.8
0.00125	372.29	0.012	43.89	0.02275	23.37	0.067	10.03	0.07775	9.38
0.0015	388.94	0.01225	73.46	0.023	23.37	0.06725	10.1	0.078	9.03
0.00175	397.45	0.0125	97.09	0.02325	23.37	0.0675	10.54	0.07825	9.23
0.002	401.76	0.01275	92.54	0.0235	15.61	0.06775	11.03	0.0785	7.66
0.00225	397.45	0.013	25.94	0.02375	2.61	0.068	11.98	0.07875	10.9
0.0025	310.28	0.01325	13.02			0.06825	12.48	0.079	9.9
0.00275	220.39	0.0135	18.2			0.0685	13.27	0.07925	8.38
0.003	138.94	0.01375	15.61			0.06875	11.95	0.0795	8.4
0.00325	52.89	0.014	15.61			0.069	12.24	0.07975	8.25
0.0035	5.22	0.01425	7.82			0.06925	12.64	0.08	8.73
0.00375	-18.38	0.0145	2.61			0.0695	12.12	0.08025	8.65

Gauge10_2 Time msec	Gauge10_2 Stress MPa	Gauge10_2 Time msec	Gauge10_2 Stress MPa	Gauge10_2 Time msec	Gauge10_2 Stress MPa	Gauge10_2 Time msec	Gauge10_2 Stress MPa	Gauge10_2 Time msec	Gauge10_2 Stress MPa
0.0805	8.63	0.09125	6.32	0.102	6.06	0.11275	6.45	0.1235	6.76
0.08075	8.04	0.0915	6.44	0.10225	6.05	0.113	8.89	0.12375	7.13
0.081	8.03	0.09175	6.36	0.1025	6.01	0.11325	6.81	0.124	7.38
0.08125	7.97	0.092	6.23	0.10275	6.26	0.1135	7.79	0.12425	7.86
0.0815	8.53	0.09225	6.27	0.103	5.99	0.11375	8.08	0.1245	8.03
0.08175	8.72	0.0925	6.18	0.10325	6.58	0.114	7.47	0.12475	8.03
0.082	8.66	0.09275	6.47	0.1035	6.25	0.11425	6.83	0.125	7.81
0.08225	8.26	0.093	6.1	0.10375	6.08	0.1145	6.63	0.12525	7.47
0.0825	7.61	0.09325	7.55	0.104	6.21	0.11475	6.96	0.1255	7.21
0.08275	7.76	0.0935	6.25	0.10425	6.2	0.115	7.59	0.12575	7.1
0.083	7.68	0.09375	4.69	0.1045	6.34	0.11525	7.98	0.126	7.09
0.08325	9.04	0.094	6.09	0.10475	6.18	0.1155	8.05	0.12625	7.41
0.0835	8.23	0.09425	5.74	0.105	6.41	0.11575	7.53	0.1265	7.48
0.08375	7.41	0.0945	5.98	0.10525	6.39	0.116	7.36	0.12675	7.98
0.084	9.08	0.09475	5.92	0.1055	6.88	0.11625	6.95	0.127	7.79
0.08425	8.23	0.095	5.95	0.10575	7.13	0.1165	7.56	0.12725	8.13
0.0845	8.67	0.09525	6.48	0.106	7.49	0.11675	7.39	0.1275	7.63
0.08475	8.2	0.0955	6.66	0.10625	7.5	0.117	8.16	0.12775	8.09
0.085	8.67	0.09575	7.3	0.1065	7.12	0.11725	7.38	0.128	7.62
0.08525	8.03	0.096	7.01	0.10675	6.65	0.1175	7.92	0.12825	7.63
0.0855	8.22	0.09625	7.1	0.107	5.76	0.11775	6.57	0.1285	7.73
0.08575	7.49	0.0965	6.55	0.10725	5.51	0.118	8.01	0.12875	7.72
0.086	7.77	0.09675	6.81	0.1075	5.04	0.11825	8.66	0.129	7.62
0.08625	7.35	0.097	6.77	0.10775	5.57	0.1185	7.61	0.12925	7.45
0.0865	7.62	0.09725	7.38	0.108	5.35	0.11875	7.71	0.1295	7.45
0.08675	7.17	0.0975	7.1	0.10825	5.44	0.119	7.43	0.12975	7.55
0.087	7.23	0.09775	7.08	0.1085	6.05	0.11925	7.43	0.13	7.7
0.08725	6.93	0.098	5.72	0.10875	5.3	0.1195	7.48	0.13025	7.88
0.0875	7.33	0.09825	5.25	0.109	4.92	0.11975	7.71	0.1305	7.75
0.08775	7.37	0.0985	7.08	0.10925	4.67	0.12	8.06	0.13075	7.91
0.088	7.8	0.09875	6.11	0.1095	5.13	0.12025	8.24	0.131	7.89
0.08825	7.31	0.099	6.26	0.10975	5.87	0.1205	8.63	0.13125	8.62
0.0885	4.72	0.09925	6.95	0.11	6.66	0.12075	8.6	0.1315	9.1
0.08875	6.7	0.0995	6.79	0.11025	7.12	0.121	8.97	0.13175	9.98
0.089	6.79	0.09975	7	0.1105	6.93	0.12125	8.73	0.132	10.23
0.08925	5.84	0.1	6.54	0.11075	6.69	0.1215	8.88	0.13225	10.52
0.0895	6.39	0.10025	6.72	0.111	6.19	0.12175	8.44	0.1325	10.56
0.08975	5.72	0.1005	6.74	0.11125	6.33	0.122	8.3	0.13275	10.83
0.09	6.09	0.10075	7.09	0.1115	6.38	0.12225	7.86	0.133	11.55
0.09025	5.49	0.101	7.18	0.11175	6.67	0.1225	7.57	0.13325	11.93
0.0905	5.81	0.10125	7.06	0.112	6.57	0.12275	7.3	0.1335	12.29
0.09075	5.72	0.1015	6.74	0.11225	6.25	0.123	8.67	0.13375	12.07
0.091	6.19	0.10175	6.33	0.1125	6.37	0.12325	6.9	0.134	11.73

Gauge10_2 Time msec	Gauge10_2 Stress MPa	Gauge10_2 Time msec	Gauge10_2 Stress MPa	Gauge10_2 Time msec	Gauge10_2 Stress MPa	Gauge10_2 Time msec	Gauge10_2 Stress MPa	Gauge10_2 Time msec	Gauge10_2 Stress MPa
0.13425	11.35	0.145	4.19	0.15575	5.22	0.1665	5.52	0.17725	4.16
0.1345	11.14	0.14525	4.06	0.156	5.1	0.16675	6.24	0.1775	2.96
0.13475	11.28	0.1455	4.12	0.15625	5.36	0.167	3.7	0.17775	3.48
0.135	11.15	0.14575	4.22	0.1565	5.3	0.16725	2.67	0.178	3.81
0.13525	11.1	0.146	4.35	0.15675	5.15	0.1675	7.3	0.17825	3.4
0.1355	10.45	0.14625	4.54	0.157	4.61	0.16775	4.58	0.1785	3.27
0.13575	10.08	0.1465	4.61	0.15725	4.11	0.168	4.38	0.17875	2.83
0.136	9.55	0.14675	4.97	0.1575	7.77	0.16825	4.18	0.179	3.11
0.13625	9.42	0.147	5.04	0.15775	4.16	0.1685	4.19	0.17925	3.24
0.1365	9.19	0.14725	5.38	0.158	4.02	0.16875	4.39	0.1795	3.64
0.13675	8.89	0.1475	5.31	0.15825	3.91	0.169	4.38	0.17975	3.46
0.137	8.39	0.14775	5.13	0.1585	4.03	0.16925	4.56	0.18	3.37
0.13725	7.83	0.148	4.83	0.15875	4.72	0.1695	4.36	0.18025	2.86
0.1375	7.08	0.14825	4.77	0.159	5.29	0.16975	4.46	0.1805	2.95
0.13775	7.82	0.1485	4.69	0.15925	6.29	0.17	4.13	0.18075	2.84
0.138	7.41	0.14875	4.64	0.1595	6.36	0.17025	4.43	0.181	3.34
0.13825	6.62	0.149	4.75	0.15975	6.52	0.1705	4.23	0.18125	3.34
0.1385	6.51	0.14925	4.67	0.16	5.84	0.17075	4.73	0.1815	3.54
0.13875	6.15	0.1495	4.91	0.16025	5.95	0.171	4.35	0.18175	3.34
0.139	6.07	0.14975	4.98	0.1605	5.95	0.17125	4.45	0.182	2.3
0.13925	6.23	0.15	5.26	0.16075	6.91	0.1715	3.85	0.18225	3.58
0.1395	6.4	0.15025	5.35	0.161	7.13	0.17175	3.76	0.1825	3.43
0.13975	6.58	0.1505	5.3	0.16125	7.56	0.172	4.48	0.18275	3.39
0.14	6.46	0.15075	5.25	0.1615	6.36	0.17225	2.91	0.183	3.14
0.14025	6.15	0.151	5.01	0.16175	6.51	0.1725	3.76	0.18325	3.32
0.1405	5.84	0.15125	5.19	0.162	4.82	0.17275	4.91	0.1835	3.05
0.14075	5.45	0.1515	5.16	0.16225	10.18	0.173	4.12	0.18375	3.4
0.141	5.38	0.15175	5.65	0.1625	8.73	0.17325	3.29	0.184	3.23
0.14125	5.04	0.152	5.71	0.16275	6.78	0.1735	2.19	0.18425	3.54
0.1415	5	0.15225	6.41	0.163	9.1	0.17375	1.74	0.1845	3.33
0.14175	4.64	0.1525	6.15	0.16325	7.85	0.174	2.19	0.18475	3.4
0.142	4.64	0.15275	5.72	0.1635	7.24	0.17425	3.08	0.185	3.16
0.14225	4.49	0.153	6.63	0.16375	5.63	0.1745	4.06	0.18525	3.23
0.1425	4.79	0.15325	6.21	0.164	5.17	0.17475	4.21	0.1855	3.2
0.14275	5.16	0.1535	6.3	0.16425	4.94	0.175	3.97	0.18575	3.46
0.143	4.12	0.15375	5.74	0.1645	5.45	0.17525	3.09	0.186	3.34
0.14325	4.44	0.154	5.72	0.16475	5.63	0.1755	2.93	0.18625	3.32
0.1435	4.03	0.15425	5.63	0.165	5.63	0.17575	2.63	0.1865	2.41
0.14375	4.44	0.1545	5.86	0.16525	5.25	0.176	3.48	0.18675	2.01
0.144	4.37	0.15475	6.06	0.1655	4.82	0.17625	3.11		
0.14425	4.7	0.155	5.9	0.16575	4.97	0.1765	3.82		
0.1445	4.54	0.15525	5.76	0.166	4.98	0.17675	2.26		
0.14475	4.43	0.1555	5.24	0.16625	5.95	0.177	3.8		

Gauge10_3 Time msec	Gauge10_3 Stress MPa	Gauge10_3 Time msec	Gauge10_3 Stress MPa	Gauge10_3 Time msec	Gauge10_3 Stress MPa	Gauge10_3 Time msec	Gauge10_3 Stress MPa	Gauge10_3 Time msec	Gauge10_3 Stress MPa
0.0485	0.224	0.07	2.24	0.0915	11.18	0.113	8.73	0.1345	12.3
0.049	-0.449	0.0705	4.26	0.092	10.96	0.1135	9.4	0.135	11.41
0.0495	-0.224	0.071	9.18	0.0925	10.96	0.114	6.94	0.1355	12.3
0.05	0	0.0715	15.42	0.093	11.85	0.1145	10.52	0.136	9.85
0.0505	0	0.072	18.53	0.0935	11.18	0.115	10.07	0.1365	7.84
0.051	0	0.0725	19.86	0.094	9.62	0.1155	9.62	0.137	10.29
0.0515	0	0.073	15.86	0.0945	9.62	0.116	10.07	0.1375	9.62
0.052	-0.224	0.0735	12.97	0.095	7.39	0.1165	9.18	0.138	8.51
0.0525	0	0.074	12.52	0.0955	7.61	0.117	9.85	0.1385	6.72
0.053	0	0.0745	12.52	0.096	8.95	0.1175	8.51	0.139	8.28
0.0535	0	0.075	12.3	0.0965	8.28	0.118	10.52	0.1395	7.39
0.054	0	0.0755	12.52	0.097	8.06	0.1185	9.18	0.14	8.95
0.0545	0	0.076	12.74	0.0975	9.18	0.119	8.95	0.1405	6.94
0.055	0	0.0765	12.97	0.098	8.51	0.1195	9.62	0.141	6.5
0.0555	0.224	0.077	13.19	0.0985	7.17	0.12	8.95	0.1415	10.96
0.056	0	0.0775	13.19	0.099	7.17	0.1205	8.73	0.142	6.27
0.0565	0	0.078	12.74	0.0995	8.73	0.121	8.51	0.1425	4.03
0.057	0	0.0785	12.52	0.1	7.61	0.1215	10.29	0.143	5.6
0.0575	0	0.079	12.08	0.1005	7.61	0.122	8.73	0.1435	5.38
0.058	0	0.0795	11.85	0.101	8.28	0.1225	7.39	0.144	4.93
0.0585	0	0.08	11.41	0.1015	8.28	0.123	8.73	0.1445	5.38
0.059	0.224	0.0805	11.41	0.102	7.84	0.1235	8.73	0.145	5.6
0.0595	0	0.081	11.63	0.1025	8.06	0.124	8.51	0.1455	5.82
0.06	0.224	0.0815	11.63	0.103	7.61	0.1245	9.4	0.146	5.6
0.0605	0	0.082	11.18	0.1035	7.17	0.125	8.51	0.1465	5.38
0.061	0	0.0825	10.96	0.104	8.73	0.1255	10.52	0.147	5.6
0.0615	0	0.083	10.96	0.1045	8.28	0.126	9.62	0.1475	5.82
0.062	0	0.0835	10.96	0.105	8.51	0.1265	8.06	0.148	5.6
0.0625	0	0.084	10.96	0.1055	7.84	0.127	9.4	0.1485	5.6
0.063	0	0.0845	10.96	0.106	7.84	0.1275	8.28	0.149	5.82
0.0635	-0.224	0.085	10.96	0.1065	8.51	0.128	9.4	0.1495	5.82
0.064	0.224	0.0855	10.96	0.107	8.06	0.1285	8.28	0.15	5.82
0.0645	0	0.086	10.74	0.1075	8.06	0.129	6.27	0.1505	6.05
0.065	0.224	0.0865	10.52	0.108	9.18	0.1295	6.72	0.151	6.5
0.0655	0.224	0.087	10.52	0.1085	8.28	0.13	6.27	0.1515	6.5
0.066	0.224	0.0875	10.74	0.109	8.73	0.1305	8.28	0.152	5.82
0.0665	0.224	0.088	10.07	0.1095	8.06	0.131	9.4	0.1525	6.05
0.067	0.224	0.0885	10.29	0.11	8.73	0.1315	10.07	0.153	6.27
0.0675	0	0.089	10.52	0.1105	8.51	0.132	10.74	0.1535	0.224
0.068	0.449	0.0895	10.29	0.111	8.51	0.1325	11.63	0.154	6.27
0.0685	0.224	0.09	10.29	0.1115	8.51	0.133	9.85	0.1545	4.71
0.069	0.673	0.0905	11.85	0.112	9.18	0.1335	10.96	0.155	5.38
0.0695	1.12	0.091	11.41	0.1125	8.51	0.134	11.85	0.1555	4.93

Gauge10_3 Time msec	Gauge10_3 Stress MPa	Gauge10_3 Time msec	Gauge10_3 Stress MPa	Gauge10_3 Time msec	Gauge10_3 Stress MPa	Gauge10_3 Time msec	Gauge10_3 Stress MPa	Gauge10_4 Time msec	Gauge10_4 Stress MPa
0.156	6.05	0.1775	6.72	0.199	4.93	0.2205	5.38	0.073	0.22
0.1565	6.5	0.178	6.72	0.1995	4.71	0.221	5.15	0.0735	0
0.157	6.27	0.1785	6.5	0.2	4.93	0.2215	5.15	0.074	0.22
0.1575	6.5	0.179	6.5	0.2005	4.71	0.222	5.15	0.0745	0.22
0.158	6.5	0.1795	6.72	0.201	4.71	0.2225	5.38	0.075	0
0.1585	6.5	0.18	6.5	0.2015	4.48	0.223	5.15	0.0755	-0.44
0.159	6.05	0.1805	6.5	0.202	4.71	0.2235	4.93	0.076	0
0.1595	5.82	0.181	6.05	0.2025	4.71	0.224	4.71	0.0765	0
0.16	4.93	0.1815	6.5	0.203	4.93	0.2245	5.15	0.077	0
0.1605	5.15	0.182	6.72	0.2035	4.93	0.225	4.93	0.0775	0.22
0.161	5.6	0.1825	6.5	0.204	4.93	0.2255	4.93	0.078	0
0.1615	6.05	0.183	6.5	0.2045	5.15	0.226	4.71	0.0785	0
0.162	6.05	0.1835	6.27	0.205	4.93	0.2265	4.71	0.079	0.22
0.1625	6.05	0.184	6.27	0.2055	4.93	0.227	4.71	0.0795	0.22
0.163	6.27	0.1845	6.27	0.206	4.93	0.2275	3.14	0.08	0
0.1635	5.6	0.185	6.27	0.2065	4.93	0.228	4.48	0.0805	0
0.164	5.38	0.1855	6.27	0.207	4.93	0.2285	4.48	0.081	0.22
0.1645	5.38	0.186	6.27	0.2075	4.93	0.229	4.48	0.0815	0.22
0.165	5.15	0.1865	6.72	0.208	5.15	0.2295	4.48	0.082	0.22
0.1655	5.6	0.187	6.5	0.2085	4.93	0.23	4.48	0.0825	0
0.166	5.82	0.1875	6.5	0.209	5.15	0.2305	4.48	0.083	0.22
0.1665	5.38	0.188	6.27	0.2095	4.93	0.231	4.71	0.0835	0
0.167	6.05	0.1885	6.5	0.21	4.93	0.2315	4.48	0.084	0.22
0.1675	5.82	0.189	3.59	0.2105	4.93	0.232	4.48	0.0845	0.22
0.168	5.82	0.1895	5.82	0.211	5.15	0.2325	4.71	0.085	0.22
0.1685	6.05	0.19	6.05	0.2115	5.15	0.233	4.71	0.0855	0.22
0.169	5.82	0.1905	5.6	0.212	5.15	0.2335	4.48	0.086	0.22
0.1695	5.6	0.191	5.82	0.2125	5.38	0.234	4.48	0.0865	0.22
0.17	6.05	0.1915	5.6	0.213	5.15	0.2345	4.48	0.087	0.22
0.1705	6.05	0.192	5.6	0.2135	5.15	0.235	4.71	0.0875	0
0.171	5.82	0.1925	5.82	0.214	5.15	0.2355	4.48	0.088	0.22
0.1715	5.82	0.193	5.6	0.2145	4.93	0.236	4.48	0.0885	-0.22
0.172	5.82	0.1935	5.15	0.215	5.15	0.2365	4.48	0.089	0.22
0.1725	6.27	0.194	5.6	0.2155	5.82	0.237	4.71	0.0895	0.22
0.173	6.5	0.1945	5.15	0.216	5.15	0.2375	4.71	0.09	0
0.1735	6.5	0.195	5.38	0.2165	4.93	0.238	4.48	0.0905	0
0.174	6.94	0.1955	5.6	0.217	4.71	0.2385	4.48	0.091	0
0.1745	6.5	0.196	5.38	0.2175	4.93	0.239	5.15	0.0915	0
0.175	6.5	0.1965	5.38	0.218	4.93	0.2395	4.71	0.092	0
0.1755	6.27	0.197	5.38	0.2185	4.93	0.24	4.48	0.0925	0
0.176	6.5	0.1975	5.38	0.219	4.93	0.2405	4.71	0.093	0
0.1765	6.5	0.198	5.15	0.2195	5.15	0.241	4.48	0.0935	0
0.177	6.72	0.1985	4.93	0.22	5.38	0.2415	4.71	0.094	0

Gauge10_4	Gauge10_4	Gauge10_4	Gauge10_4	Gauge10_4	Gauge10_4	Gauge10_4	Gauge10_4	Gauge10_4	Gauge10_4
Time	Stress	Time	Stress	Time	Stress	Time	Stress	Time	Stress
msec	MPa	msec	MPa	msec	MPa	msec	MPa	msec	MPa
0.0945	0	0.116	0.22	0.1375	6.37	0.159	4.18	0.1805	3.52
0.095	0	0.1165	0.22	0.138	6.15	0.1595	4.18	0.181	2.2
0.0955	0	0.117	0.22	0.1385	6.15	0.16	3.96	0.1815	1.98
0.096	0.22	0.1175	0.22	0.139	6.15	0.1605	4.4	0.182	1.54
0.0965	0.22	0.118	0.22	0.1395	5.71	0.161	4.62	0.1825	4.18
0.097	0.22	0.1185	0.44	0.14	5.71	0.1615	4.62	0.183	3.08
0.0975	0.22	0.119	0	0.1405	5.49	0.162	5.27	0.1835	3.74
0.098	0.22	0.1195	0.22	0.141	5.49	0.1625	4.4	0.184	3.52
0.0985	0.22	0.12	0.22	0.1415	5.05	0.163	4.62	0.1845	3.08
0.099	0	0.1205	0.22	0.142	5.05	0.1635	4.4	0.185	3.96
0.0995	0.22	0.121	0.22	0.1425	5.05	0.164	4.4	0.1855	3.96
0.1	0.22	0.1215	0.66	0.143	5.05	0.1645	4.18	0.186	4.84
0.1005	0.22	0.122	0.44	0.1435	4.84	0.165	4.4	0.1865	3.74
0.101	0.22	0.1225	0.88	0.144	4.84	0.1655	4.18	0.187	3.52
0.1015	0.22	0.123	0.88	0.1445	4.84	0.166	4.4	0.1875	4.4
0.102	0.22	0.1235	1.32	0.145	4.84	0.1665	4.18	0.188	5.93
0.1025	0.22	0.124	2.2	0.1455	4.62	0.167	4.4	0.1885	3.52
0.103	0.22	0.1245	3.74	0.146	4.62	0.1675	4.4	0.189	5.27
0.1035	0.22	0.125	6.37	0.1465	4.62	0.168	4.4	0.1895	3.52
0.104	0	0.1255	9	0.147	4.62	0.1685	3.96	0.19	3.74
0.1045	0	0.126	10.75	0.1475	4.62	0.169	4.18	0.1905	5.71
0.105	0.22	0.1265	11.63	0.148	4.18	0.1695	4.18	0.191	3.52
0.1055	0.22	0.127	12.94	0.1485	4.4	0.17	3.74	0.1915	2.42
0.106	0.22	0.1275	12.06	0.149	4.62	0.1705	3.96	0.192	3.52
0.1065	0.22	0.128	9.44	0.1495	4.84	0.171	4.18	0.1925	2.86
0.107	0	0.1285	8.34	0.15	4.62	0.1715	4.18	0.193	2.86
0.1075	0.22	0.129	7.69	0.1505	4.62	0.172	3.96	0.1935	-1.98
0.108	0.22	0.1295	7.25	0.151	4.4	0.1725	3.74	0.194	0.66
0.1085	0	0.13	7.25	0.1515	4.18	0.173	3.74	0.1945	1.54
0.109	0.22	0.1305	7.47	0.152	4.18	0.1735	3.52	0.195	2.2
0.1095	0.44	0.131	7.47	0.1525	3.96	0.174	2.86	0.1955	2.2
0.11	0.44	0.1315	7.03	0.153	3.96	0.1745	3.96	0.196	3.08
0.1105	0.22	0.132	6.81	0.1535	3.96	0.175	4.18	0.1965	3.74
0.111	0	0.1325	6.81	0.154	4.18	0.1755	3.3	0.197	4.62
0.1115	0	0.133	6.59	0.1545	3.96	0.176	3.96	0.1975	2.42
0.112	0.44	0.1335	6.37	0.155	3.96	0.1765	3.96	0.198	2.2
0.1125	0	0.134	6.15	0.1555	4.4	0.177	2.42	0.1985	0.88
0.113	0	0.1345	6.15	0.156	4.18	0.1775	3.08	0.199	0.66
0.1135	0.22	0.135	6.59	0.1565	4.18	0.178	3.96	0.1995	5.27
0.114	0.22	0.1355	6.37	0.157	4.4	0.1785	3.08	0.2	3.08
0.1145	0	0.136	6.59	0.1575	4.4	0.179	3.08	0.2005	3.96
0.115	0	0.1365	6.59	0.158	4.18	0.1795	3.74	0.201	5.49
0.1155	0.22	0.137	6.59	0.1585	4.18	0.18	3.52	0.2015	6.15

Gauge10_4	Gauge10_4	Gauge10_4	Gauge10_4	Gauge10_5	Gauge10_5	Gauge10_5	Gauge10_5	Gauge10_5	Gauge10_5
Time	Stress	Time	Stress	Time	Stress	Time	Stress	Time	Stress
msec	MPa	msec	MPa	msec	MPa	msec	MPa	msec	MPa
0.202	7.47	0.2235	3.96	0.083	-0.224	0.1045	-0.224	0.126	5.8
0.2025	3.3	0.224	3.3	0.0835	0	0.105	-0.224	0.1265	5.8
0.203	6.81	0.2245	2.86	0.084	0	0.1055	-0.224	0.127	5.58
0.2035	6.37	0.225	3.74	0.0845	0	0.106	-0.224	0.1275	5.58
0.204	3.96	0.2255	2.86	0.085	-0.224	0.1065	-0.447	0.128	5.13
0.2045	6.81	0.226	1.98	0.0855	0	0.107	-0.224	0.1285	4.91
0.205	4.18	0.2265	1.98	0.086	0	0.1075	-0.224	0.129	4.46
0.2055	3.3	0.227	-2.64	0.0865	-0.224	0.108	-0.224	0.1295	4.24
0.206	5.49	0.2275	-2.86	0.087	-0.224	0.1085	0	0.13	3.8
0.2065	5.05	0.228	0	0.0875	0	0.109	0	0.1305	4.02
0.207	1.54	0.2285	0.66	0.088	0	0.1095	-0.224	0.131	4.24
0.2075	2.42	0.229	0.44	0.0885	0	0.11	0	0.1315	4.24
0.208	3.3	0.2295	4.84	0.089	-0.447	0.1105	-0.224	0.132	4.91
0.2085	3.08	0.23	2.42	0.0895	0.224	0.111	0	0.1325	6.02
0.209	4.62	0.2305	2.64	0.09	0	0.1115	0	0.133	6.02
0.2095	3.3	0.231	1.1	0.0905	0	0.112	0.67	0.1335	6.02
0.21	3.74	0.2315	-0.66	0.091	0	0.1125	0.224	0.134	5.36
0.2105	2.86	0.232	-0.44	0.0915	0.224	0.113	0.447	0.1345	4.91
0.211	2.2	0.2325	-0.66	0.092	0.224	0.1135	0.67	0.135	5.13
0.2115	1.76	0.233	-3.3	0.0925	-0.224	0.114	1.12	0.1355	4.46
0.212	-0.22	0.2335	0	0.093	0.224	0.1145	1.56	0.136	4.02
0.2125	1.76	0.234	1.76	0.0935	0.224	0.115	2.9	0.1365	4.69
0.213	4.18	0.2345	0.22	0.094	-0.224	0.1155	4.91	0.137	4.02
0.2135	2.2	0.235	0.66	0.0945	0.224	0.116	7.36	0.1375	3.57
0.214	3.74	0.2355	2.86	0.095	0.224	0.1165	8.92	0.138	3.35
0.2145	3.74	0.236	2.42	0.0955	0	0.117	9.81	0.1385	3.35
0.215	2.2	0.2365	1.98	0.096	0.224	0.1175	10.47	0.139	3.57
0.2155	1.98	0.237	1.1	0.0965	0.224	0.118	10.03	0.1395	3.57
0.216	2.42	0.2375	1.76	0.097	0.224	0.1185	9.59	0.14	3.57
0.2165	2.42	0.238	2.42	0.0975	0	0.119	8.7	0.1405	3.35
0.217	1.54	0.2385	3.3	0.098	-0.224	0.1195	8.03	0.141	3.57
0.2175	5.49	0.239	5.49	0.0985	0	0.12	7.14	0.1415	3.57
0.218	4.4	0.2395	3.52	0.099	0	0.1205	6.69	0.142	3.57
0.2185	4.62	0.24	0	0.0995	-0.447	0.121	6.69	0.1425	3.57
0.219	2.2	0.2405	0.66	0.1	0	0.1215	6.25	0.143	3.57
0.2195	2.42	0.241	0.66	0.1005	0	0.122	6.25	0.1435	3.57
0.22	3.52	0.2415	-1.32	0.101	0.224	0.1225	6.25	0.144	3.13
0.2205	2.2	0.242	-0.88	0.1015	0	0.123	6.02	0.1445	3.13
0.221	2.64	0.2425	-1.54	0.102	0.224	0.1235	5.8	0.145	2.9
0.2215	2.2			0.1025	0	0.124	5.8	0.1455	2.68
0.222	1.98			0.103	0.224	0.1245	5.8	0.146	2.9
0.2225	2.42			0.1035	0.224	0.125	5.58	0.1465	2.68
0.223	2.86			0.104	-0.224	0.1255	5.58	0.147	2.9

Gauge10_5 Time msec	Gauge10_5 Stress MPa	Gauge10_5 Time msec	Gauge10_5 Stress MPa	Gauge10_5 Time msec	Gauge10_5 Stress MPa	Gauge10_5 Time msec	Gauge10_5 Stress MPa	Gauge10_6 Time msec	Gauge10_6 Stress MPa
0.1475	3.13	0.169	2.68	0.1905	2.46	0.212	2.01	0.143	0.225
0.148	3.13	0.1695	2.68	0.191	2.46	0.2125	2.23	0.1435	0
0.1485	3.35	0.17	2.68	0.1915	2.46	0.213	0.447	0.144	0
0.149	3.13	0.1705	2.9	0.192	2.01	0.2135	1.79	0.1445	0
0.1495	3.35	0.171	2.68	0.1925	2.01	0.214	2.23	0.145	0
0.15	3.35	0.1715	2.68	0.193	2.01	0.2145	1.79	0.1455	0.225
0.1505	3.57	0.172	2.68	0.1935	2.01	0.215	2.01	0.146	0.225
0.151	3.57	0.1725	2.68	0.194	2.01	0.2155	2.68	0.1465	0
0.1515	3.8	0.173	2.68	0.1945	2.01	0.216	2.01	0.147	0
0.152	4.02	0.1735	3.13	0.195	1.79	0.2165	2.46	0.1475	0
0.1525	3.57	0.174	3.13	0.1955	2.01	0.217	1.79	0.148	0
0.153	4.02	0.1745	3.13	0.196	2.01	0.2175	1.79	0.1485	-0.225
0.1535	3.35	0.175	3.13	0.1965	2.23	0.218	1.79	0.149	0
0.154	3.35	0.1755	3.13	0.197	2.01	0.2185	1.34	0.1495	0.225
0.1545	3.35	0.176	3.35	0.1975	1.79	0.219	1.79	0.15	0.225
0.155	3.35	0.1765	3.35	0.198	1.79	0.2195	2.01	0.1505	0.225
0.1555	3.13	0.177	3.57	0.1985	1.79	0.22	2.01	0.151	0.225
0.156	3.13	0.1775	3.57	0.199	1.56	0.2205	2.01	0.1515	0
0.1565	3.13	0.178	3.8	0.1995	2.01	0.221	2.01	0.152	0
0.157	2.9	0.1785	3.8	0.2	2.23	0.2215	2.23	0.1525	0
0.1575	2.68	0.179	3.57	0.2005	2.46	0.222	1.79	0.153	0
0.158	2.9	0.1795	3.13	0.201	2.01	0.2225	1.79	0.1535	0
0.1585	3.13	0.18	3.13	0.2015	2.23	0.223	2.01	0.154	0
0.159	2.9	0.1805	3.13	0.202	2.46	0.2235	1.79	0.1545	0
0.1595	2.9	0.181	3.13	0.2025	2.23	0.224	2.01	0.155	0.225
0.16	2.9	0.1815	2.9	0.203	2.01	0.2245	1.56	0.1555	0.225
0.1605	3.13	0.182	3.13	0.2035	2.01	0.225	0.894	0.156	0.225
0.161	2.68	0.1825	3.13	0.204	2.23	0.2255	1.79	0.1565	0.225
0.1615	2.9	0.183	3.35	0.2045	2.23	0.226	0.894	0.157	0
0.162	2.9	0.1835	3.13	0.205	2.68	0.2265	1.12	0.1575	0.225
0.1625	2.9	0.184	3.13	0.2055	2.01	0.227	1.56	0.158	0
0.163	2.68	0.1845	3.13	0.206	8.7	0.2275	1.34	0.1585	0
0.1635	2.68	0.185	3.13	0.2065	2.46	0.228	1.56	0.159	0
0.164	3.35	0.1855	3.35	0.207	0.447	0.2285	1.12	0.1595	0.225
0.1645	2.46	0.186	3.35	0.2075	1.79	0.229	1.56	0.16	0.225
0.165	2.01	0.1865	3.35	0.208	2.01	0.2295	1.56	0.1605	0.225
0.1655	2.23	0.187	3.13	0.2085	1.79	0.23	1.79	0.161	0
0.166	2.68	0.1875	3.13	0.209	1.79	0.2305	1.79	0.1615	0
0.1665	2.46	0.188	3.13	0.2095	1.79	0.231	2.01	0.162	0
0.167	2.68	0.1885	3.13	0.21	1.79	0.2315	2.23	0.1625	0
0.1675	2.68	0.189	2.68	0.2105	2.23	0.232	2.01	0.163	0
0.168	2.9	0.1895	2.68	0.211	2.01	0.2325	2.23	0.1635	0.225
0.1685	2.46	0.19	2.68	0.2115	1.56			0.164	0

Gauge10_6 Time msec	Gauge10_6 Stress MPa	Gauge10_6 Time msec	Gauge10_6 Stress MPa	Gauge10_6 Time msec	Gauge10_6 Stress MPa	Gauge10_6 Time msec	Gauge10_6 Stress MPa
0.1645	0.225	0.186	3.83	0.2075	2.48	0.229	2.48
0.165	0.225	0.1865	3.83	0.208	2.03	0.2295	2.25
0.1655	0	0.187	3.83	0.2085	2.25	0.23	2.25
0.166	0.225	0.1875	3.83	0.209	2.25	0.2305	2.25
0.1665	0	0.188	3.83	0.2095	2.25	0.231	2.25
0.167	0	0.1885	4.05	0.21	1.8		
0.1675	-0.225	0.189	3.6	0.2105	2.03		
0.168	0	0.1895	3.6	0.211	2.25		
0.1685	0.225	0.19	3.38	0.2115	2.25		
0.169	0.45	0.1905	3.38	0.212	2.25		
0.1695	0	0.191	3.6	0.2125	2.25		
0.17	0	0.1915	3.38	0.213	2.25		
0.1705	0.225	0.192	3.38	0.2135	2.03		
0.171	0.45	0.1925	3.38	0.214	1.58		
0.1715	0.676	0.193	3.38	0.2145	1.8		
0.172	1.13	0.1935	3.38	0.215	1.35		
0.1725	1.8	0.194	3.38	0.2155	1.35		
0.173	2.48	0.1945	3.38	0.216	1.35		
0.1735	3.6	0.195	3.38	0.2165	2.03		
0.174	4.72	0.1955	3.15	0.217	1.58		
0.1745	5.17	0.196	3.15	0.2175	1.58		
0.175	5.17	0.1965	3.15	0.218	1.8		
0.1755	5.62	0.197	3.15	0.2185	1.58		
0.176	6.07	0.1975	2.7	0.219	1.58		
0.1765	5.85	0.198	2.93	0.2195	1.58		
0.177	6.07	0.1985	2.7	0.22	1.8		
0.1775	6.3	0.199	2.7	0.2205	1.8		
0.178	6.3	0.1995	2.7	0.221	1.8		
0.1785	6.3	0.2	2.93	0.2215	2.03		
0.179	5.85	0.2005	2.7	0.222	2.03		
0.1795	5.4	0.201	2.48	0.2225	2.03		
0.18	5.17	0.2015	2.48	0.223	1.8		
0.1805	4.95	0.202	2.25	0.2235	1.8		
0.181	4.72	0.2025	2.48	0.224	1.8		
0.1815	4.72	0.203	2.25	0.2245	2.03		
0.182	4.72	0.2035	2.25	0.225	2.03		
0.1825	4.05	0.204	2.25	0.2255	2.03		
0.183	4.28	0.2045	2.25	0.226	2.03		
0.1835	4.28	0.205	2.25	0.2265	1.8		
0.184	4.05	0.2055	2.48	0.227	2.03		
0.1845	3.83	0.206	2.48	0.2275	2.25		
0.185	3.83	0.2065	2.48	0.228	2.25		
0.1855	3.83	0.207	2.48	0.2285	2.25		



Gauge11_1 Time msec	Gauge11_1 Stress MPa	Gauge11_1 Time msec	Gauge11_1 Stress MPa	Gauge11_1 Time msec	Gauge11_1 Stress MPa	Gauge11_1 Time msec	Gauge11_1 Stress MPa	Gauge11_2 Time msec	Gauge11_2 Stress MPa
-0.01875	2.44	-0.008	2.44	0.00275	92.7	0.0135	2.44	0.05425	0
-0.0185	2.44	-0.00775	0	0.003	51.03	0.01375	12.15	0.0545	0
-0.01825	2.44	-0.0075	0	0.00325	21.81	0.014	16.99	0.05475	-0.222
-0.018	2.44	-0.00725	2.44	0.0035	14.57	0.01425	19.4	0.055	0
-0.01775	2.44	-0.007	0	0.00375	7.3	0.0145	19.4	0.05525	0
-0.0175	0	-0.00675	2.44	0.004	19.4	0.01475	19.4	0.0555	-0.222
-0.01725	2.44	-0.0065	2.44	0.00425	-17.16	0.015	19.4	0.05575	0
-0.017	2.44	-0.00625	2.44	0.0045	-17.16	0.01525	21.81	0.056	0.222
-0.01675	2.44	-0.006	2.44	0.00475	7.3	0.0155	26.62	0.05625	-0.222
-0.0165	2.44	-0.00575	0	0.005	-7.33	0.01575	31.42	0.0565	0
-0.01625	2.44	-0.0055	-2.44	0.00525	9.73	0.016	33.81	0.05675	-0.222
-0.016	2.44	-0.00525	0	0.0055	16.99	0.01625	36.2	0.057	0
-0.01575	2.44	-0.005	0	0.00575	21.81	0.0165	40.97	0.05725	-0.222
-0.0155	2.44	-0.00475	0	0.006	24.22	0.01675	43.35	0.0575	-0.222
-0.01525	2.44	-0.0045	-2.44	0.00625	7.3	0.017	43.35	0.05775	0
-0.015	2.44	-0.00425	0	0.0065	-2.44	0.01725	38.59	0.058	-0.222
-0.01475	2.44	-0.004	0	0.00675	-4.89	0.0175	33.81	0.05825	-0.222
-0.0145	2.44	-0.00375	0	0.007	-4.89	0.01775	29.02	0.0585	0
-0.01425	2.44	-0.0035	2.44	0.00725	19.4	0.018	26.62	0.05875	-0.222
-0.014	2.44	-0.00325	0	0.0075	29.02	0.01825	24.22	0.059	0
-0.01375	2.44	-0.003	-2.44	0.00775	43.35	0.0185	21.81	0.05925	-0.444
-0.0135	2.44	-0.00275	0	0.008	56	0.01875	14.57	0.0595	0
-0.01325	2.44	-0.0025	0	0.00825	65.67	0.019	2.44	0.05975	-0.666
-0.013	2.44	-0.00225	0	0.0085	84	0.01925	9.73	0.06	0
-0.01275	2.44	-0.002	0	0.00875	79.54			0.06025	-0.222
-0.0125	2.44	-0.00175	-2.44	0.009	88.39			0.0605	0
-0.01225	0	-0.0015	-2.44	0.00925	96.94			0.06075	0
-0.012	0	-0.00125	0	0.0095	88.39			0.061	-0.444
-0.01175	2.44	-0.001	0	0.00975	84			0.06125	0.222
-0.0115	2.44	-0.00075	0	0.01	70.38			0.0615	-0.222
-0.01125	2.44	-0.0005	-2.44	0.01025	45.96			0.06175	0.222
-0.011	2.44	-0.00025	-4.89	0.0105	51.03			0.062	0.444
-0.01075	2.44	0	4.87	0.01075	40.97			0.06225	0
-0.0105	0	0.00025	7.3	0.011	33.81			0.0625	0.222
-0.01025	2.44	0.0005	7.3	0.01125	26.62			0.06275	0
-0.01	2.44	0.00075	2.44	0.0115	24.22			0.063	0
-0.00975	2.44	0.001	16.99	0.01175	16.99			0.06325	0.222
-0.0095	0	0.00125	29.02	0.012	9.73			0.0635	0
-0.00925	2.44	0.0015	19.4	0.01225	12.15			0.06375	0
-0.009	0	0.00175	24.22	0.0125	14.57			0.064	0.222
-0.00875	2.44	0.002	38.59	0.01275	2.44			0.06425	0.222
-0.0085	2.44	0.00225	0	0.013	-2.44			0.0645	0
-0.00825	2.44	0.0025	21.81	0.01325	-4.89			0.06475	0

Gauge11_2 Time msec	Gauge11_2 Stress MPa	Gauge11_2 Time msec	Gauge11_2 Stress MPa	Gauge11_2 Time msec	Gauge11_2 Stress MPa	Gauge11_2 Time msec	Gauge11_2 Stress MPa	Gauge11_2 Time msec	Gauge11_2 Stress MPa
0.065	0.222	0.07575	0.665	0.0865	9.07	0.09725	7.08	0.108	5.98
0.06525	0	0.076	0.444	0.08675	9.07	0.0975	7.08	0.10825	5.98
0.0655	0	0.07625	0.887	0.087	9.07	0.09775	7.08	0.1085	5.76
0.06575	0	0.0765	0.665	0.08725	8.85	0.098	7.08	0.10875	6.42
0.066	0	0.07675	0.887	0.0875	8.63	0.09825	6.86	0.109	5.98
0.06625	0.444	0.077	0.887	0.08775	8.85	0.0985	7.08	0.10925	6.64
0.0665	1.11	0.07725	1.11	0.088	7.75	0.09875	7.08	0.1095	6.42
0.06675	0.222	0.0775	1.33	0.08825	8.19	0.099	7.08	0.10975	6.42
0.067	0.887	0.07775	1.11	0.0885	8.85	0.09925	7.3	0.11	6.86
0.06725	0.222	0.078	1.55	0.08875	7.97	0.0995	6.86	0.11025	5.98
0.0675	0.665	0.07825	2	0.089	8.41	0.09975	7.08	0.1105	6.2
0.06775	0.444	0.0785	2.44	0.08925	5.54	0.1	7.08	0.11075	6.64
0.068	0.444	0.07875	2.88	0.0895	6.64	0.10025	7.08	0.111	6.42
0.06825	0.444	0.079	3.77	0.08975	9.29	0.1005	7.08	0.11125	6.64
0.0685	0.444	0.07925	4.43	0.09	9.29	0.10075	6.86	0.1115	6.42
0.06875	0.444	0.0795	5.54	0.09025	9.51	0.101	6.86	0.11175	6.42
0.069	0.222	0.07975	6.64	0.0905	7.75	0.10125	6.86	0.112	6.42
0.06925	0.222	0.08	8.19	0.09075	7.97	0.1015	6.64	0.11225	6.42
0.0695	0.222	0.08025	9.73	0.091	7.97	0.10175	6.64	0.1125	5.98
0.06975	0.444	0.0805	10.39	0.09125	7.75	0.102	6.42	0.11275	6.42
0.07	0.222	0.08075	11.05	0.0915	7.75	0.10225	6.42	0.113	6.64
0.07025	0.222	0.081	10.83	0.09175	7.52	0.1025	6.2	0.11325	6.42
0.0705	0.222	0.08125	10.83	0.092	7.52	0.10275	6.2	0.1135	6.42
0.07075	0.222	0.0815	9.73	0.09225	7.52	0.103	6.2	0.11375	6.42
0.071	0.222	0.08175	6.63	0.0925	7.3	0.10325	6.2	0.114	6.42
0.07125	0.444	0.082	8.41	0.09275	7.08	0.1035	6.2	0.11425	6.2
0.0715	0.444	0.08225	8.41	0.093	7.3	0.10375	6.2	0.1145	6.42
0.07175	0.444	0.0825	8.41	0.09325	6.86	0.104	6.2	0.11475	6.42
0.072	0.444	0.08275	7.75	0.0935	6.86	0.10425	5.98	0.115	6.64
0.07225	0.444	0.083	8.85	0.09375	6.64	0.1045	5.76	0.11525	6.64
0.0725	0.665	0.08325	8.41	0.094	6.64	0.10475	5.76	0.1155	6.64
0.07275	0.665	0.0835	8.85	0.09425	6.42	0.105	5.76	0.11575	6.42
0.073	0.665	0.08375	8.63	0.0945	6.2	0.10525	5.76	0.116	6.64
0.07325	0.444	0.084	8.41	0.09475	6.64	0.1055	5.76	0.11625	6.64
0.0735	0.444	0.08425	8.63	0.095	6.42	0.10575	5.76	0.1165	6.42
0.07375	0.444	0.0845	8.63	0.09525	6.42	0.106	5.98	0.11675	6.64
0.074	0.444	0.08475	8.85	0.0955	6.64	0.10625	5.54	0.117	6.64
0.07425	0.887	0.085	9.07	0.09575	6.86	0.1065	5.76	0.11725	6.64
0.0745	0.222	0.08525	9.07	0.096	7.3	0.10675	5.54	0.1175	6.64
0.07475	0.222	0.0855	9.07	0.09625	6.86	0.107	5.98	0.11775	6.86
0.075	0.665	0.08575	9.07	0.0965	6.86	0.10725	5.76	0.118	6.42
0.07525	0.222	0.086	9.07	0.09675	6.86	0.1075	5.98	0.11825	6.64
0.0755	0.887	0.08625	9.07	0.097	6.86	0.10775	5.76	0.1185	6.2

Gauge11_2 Time msec	Gauge11_2 Stress MPa	Gauge11_2 Time msec	Gauge11_2 Stress MPa	Gauge11_2 Time msec	Gauge11_2 Stress MPa	Gauge11_2 Time msec	Gauge11_2 Stress MPa	Gauge11_2 Time msec	Gauge11_2 Stress MPa
0.11875	5.98	0.1295	5.98	0.14025	7.3	0.151	7.52	0.16175	6.64
0.119	6.2	0.12975	6.2	0.1405	7.3	0.15125	7.52	0.162	6.64
0.11925	5.76	0.13	6.2	0.14075	7.3	0.1515	7.3	0.16225	6.86
0.1195	5.98	0.13025	5.76	0.141	7.3	0.15175	7.3	0.1625	7.08
0.11975	5.54	0.1305	6.42	0.14125	7.52	0.152	7.3	0.16275	6.64
0.12	5.76	0.13075	6.2	0.1415	7.52	0.15225	6.86	0.163	6.2
0.12025	5.54	0.131	6.86	0.14175	7.52	0.1525	7.3	0.16325	6.42
0.1205	5.54	0.13125	6.2	0.142	7.3	0.15275	7.3	0.1635	6.2
0.12075	5.76	0.1315	6.86	0.14225	7.3	0.153	7.3	0.16375	6.2
0.121	5.76	0.13175	6.2	0.1425	7.3	0.15325	7.52	0.164	6.2
0.12125	6.2	0.132	6.64	0.14275	7.3	0.1535	7.3	0.16425	6.2
0.1215	6.2	0.13225	6.42	0.143	7.3	0.15375	7.52	0.1645	6.2
0.12175	5.76	0.1325	6.42	0.14325	7.3	0.154	7.3	0.16475	6.2
0.122	5.76	0.13275	6.86	0.1435	7.3	0.15425	7.3	0.165	6.2
0.12225	5.98	0.133	6.64	0.14375	7.3	0.1545	7.3	0.16525	5.98
0.1225	5.76	0.13325	6.64	0.144	7.3	0.15475	7.3	0.1655	6.2
0.12275	5.98	0.1335	6.42	0.14425	7.08	0.155	7.3	0.16575	5.76
0.123	5.54	0.13375	6.42	0.1445	7.3	0.15525	7.3	0.166	5.98
0.12325	5.76	0.134	6.42	0.14475	7.52	0.1555	7.52	0.16625	5.98
0.1235	5.54	0.13425	6.64	0.145	7.3	0.15575	7.3	0.1665	5.76
0.12375	5.54	0.1345	6.64	0.14525	7.52	0.156	7.52	0.16675	5.98
0.124	5.76	0.13475	6.64	0.1455	7.75	0.15625	7.52	0.167	5.98
0.12425	5.54	0.135	6.86	0.14575	6.86	0.1565	7.3	0.16725	6.2
0.1245	5.76	0.13525	6.86	0.146	7.75	0.15675	7.52	0.1675	6.2
0.12475	5.32	0.1355	6.86	0.14625	7.52	0.157	7.3	0.16775	6.2
0.125	5.32	0.13575	6.64	0.1465	7.52	0.15725	7.3	0.168	5.98
0.12525	6.2	0.136	7.08	0.14675	7.52	0.1575	7.08	0.16825	5.76
0.1255	5.32	0.13625	7.08	0.147	7.3	0.15775	7.08	0.1685	5.98
0.12575	5.76	0.1365	6.64	0.14725	7.52	0.158	7.3	0.16875	5.98
0.126	5.76	0.13675	6.42	0.1475	7.52	0.15825	7.97	0.169	5.76
0.12625	5.32	0.137	7.08	0.14775	7.3	0.1585	8.41	0.16925	5.98
0.1265	5.76	0.13725	6.86	0.148	7.52	0.15875	8.41	0.1695	5.54
0.12675	5.54	0.1375	6.64	0.14825	7.3	0.159	7.75	0.16975	5.76
0.127	5.54	0.13775	7.75	0.1485	7.52	0.15925	6.86	0.17	5.54
0.12725	5.54	0.138	5.09	0.14875	7.3	0.1595	7.08	0.17025	5.76
0.1275	5.54	0.13825	7.97	0.149	7.3	0.15975	7.75	0.1705	5.98
0.12775	5.76	0.1385	6.64	0.14925	7.08	0.16	7.52	0.17075	5.54
0.128	5.76	0.13875	7.3	0.1495	7.08	0.16025	7.75	0.171	5.76
0.12825	5.76	0.139	7.3	0.14975	7.3	0.1605	7.75	0.17125	5.54
0.1285	5.98	0.13925	6.64	0.15	7.52	0.16075	7.75	0.1715	5.98
0.12875	5.98	0.1395	7.3	0.15025	7.08	0.161	7.3	0.17175	5.98
0.129	5.98	0.13975	7.08	0.1505	7.3	0.16125	7.3	0.172	5.76
0.12925	5.98	0.14	7.3	0.15075	7.3	0.1615	6.42	0.17225	5.76

Gauge11_2 Time msec	Gauge11_2 Stress MPa	Gauge11_2 Time msec	Gauge11_2 Stress MPa	Gauge11_2 Time msec	Gauge11_2 Stress MPa	Gauge11_2 Time msec	Gauge11_2 Stress MPa	Gauge11_2 Time msec	Gauge11_2 Stress MPa
0.1725	5.76	0.18325	7.75	0.194	7.97	0.20475	8.63	0.2155	8.63
0.17275	5.32	0.1835	7.52	0.19425	7.75	0.205	8.63	0.21575	8.63
0.173	5.76	0.18375	7.52	0.1945	7.97	0.20525	8.41	0.216	8.63
0.17325	5.76	0.184	7.52	0.19475	7.97	0.2055	7.97	0.21625	8.63
0.1735	5.98	0.18425	7.3	0.195	7.75	0.20575	8.41	0.2165	8.19
0.17375	6.2	0.1845	7.08	0.19525	7.75	0.206	8.19	0.21675	8.19
0.174	6.2	0.18475	7.3	0.1955	7.75	0.20625	8.63	0.217	8.63
0.17425	5.98	0.185	7.3	0.19575	8.19	0.2065	8.41	0.21725	8.41
0.1745	6.42	0.18525	7.3	0.196	7.97	0.20675	8.41	0.2175	8.41
0.17475	6.42	0.1855	7.52	0.19625	8.19	0.207	8.41	0.21775	8.19
0.175	6.64	0.18575	7.52	0.1965	7.97	0.20725	8.19	0.218	7.97
0.17525	6.64	0.186	7.75	0.19675	7.97	0.2075	8.19	0.21825	8.19
0.1755	6.86	0.18625	7.52	0.197	7.97	0.20775	8.41	0.2185	8.41
0.17575	7.08	0.1865	7.3	0.19725	7.97	0.208	7.97	0.21875	8.19
0.176	7.08	0.18675	7.75	0.1975	7.97	0.20825	8.19	0.219	8.41
0.17625	7.08	0.187	7.3	0.19775	8.41	0.2085	8.19	0.21925	8.41
0.1765	7.08	0.18725	7.52	0.198	8.41	0.20875	8.19	0.2195	8.41
0.17675	7.52	0.1875	7.3	0.19825	7.75	0.209	8.41	0.21975	7.3
0.177	7.3	0.18775	7.3	0.1985	8.19	0.20925	8.19	0.22	7.08
0.17725	7.52	0.188	7.52	0.19875	7.97	0.2095	8.85	0.22025	7.52
0.1775	7.3	0.18825	7.3	0.199	8.19	0.20975	8.63	0.2205	7.75
0.17775	7.75	0.1885	7.52	0.19925	8.19	0.21	7.75	0.22075	7.75
0.178	7.52	0.18875	7.75	0.1995	8.41	0.21025	8.85	0.221	7.97
0.17825	7.52	0.189	7.75	0.19975	8.41	0.2105	7.97	0.22125	7.97
0.1785	7.52	0.18925	7.75	0.2	8.41	0.21075	8.41	0.2215	7.97
0.17875	7.52	0.1895	7.52	0.20025	8.41	0.211	8.19	0.22175	8.19
0.179	7.75	0.18975	7.52	0.2005	8.41	0.21125	7.97	0.222	7.97
0.17925	7.75	0.19	7.75	0.20075	8.63	0.2115	8.41	0.22225	7.75
0.1795	7.52	0.19025	7.52	0.201	8.41	0.21175	8.19	0.2225	7.75
0.17975	7.52	0.1905	7.75	0.20125	8.41	0.212	8.41	0.22275	7.75
0.18	7.52	0.19075	7.75	0.2015	8.41	0.21225	8.41	0.223	7.52
0.18025	7.52	0.191	7.52	0.20175	8.63	0.2125	8.19	0.22325	7.52
0.1805	7.75	0.19125	7.75	0.202	8.63	0.21275	8.85	0.2235	7.97
0.18075	7.52	0.1915	7.97	0.20225	8.63	0.213	8.63	0.22375	7.75
0.181	7.52	0.19175	7.97	0.2025	8.63	0.21325	8.41	0.224	7.75
0.18125	7.52	0.192	7.97	0.20275	8.63	0.2135	8.85	0.22425	7.75
0.1815	7.75	0.19225	7.75	0.203	8.85	0.21375	8.41	0.2245	7.75
0.18175	7.3	0.1925	7.75	0.20325	8.41	0.214	8.41	0.22475	7.75
0.182	7.52	0.19275	7.97	0.2035	8.85	0.21425	8.19	0.225	7.97
0.18225	7.52	0.193	7.75	0.20375	8.41	0.2145	8.41	0.22525	7.75
0.1825	7.3	0.19325	7.75	0.204	8.63	0.21475	8.63	0.2255	7.97
0.18275	7.3	0.1935	8.19	0.20425	8.63	0.215	8.41	0.22575	7.97
0.183	7.08	0.19375	7.75	0.2045	8.63	0.21525	8.85	0.226	7.75

Gauge11_2 Time msec	Gauge11_2 Stress MPa	Gauge11_2 Time msec	Gauge11_2 Stress MPa	Gauge11_3 Time msec	Gauge11_3 Stress MPa	Gauge11_3 Time msec	Gauge11_3 Stress MPa	Gauge11_3 Time msec	Gauge11_3 Stress MPa
0.22625	7.75	0.237	7.3	0.06025	0.222	0.08175	4.22	0.10325	1.33
0.2265	7.3	0.23725	7.3	0.06075	0.222	0.08225	4.22	0.10375	1.33
0.22675	7.75	0.2375	7.3	0.06125	0.222	0.08275	4.22	0.10425	1.55
0.227	7.3	0.23775	6.64	0.06175	0.222	0.08325	4.44	0.10475	1.55
0.22725	7.3	0.238	7.75	0.06225	0.222	0.08375	4.44	0.10525	1.78
0.2275	7.3	0.23825	7.08	0.06275	0	0.08425	4.66	0.10575	1.78
0.22775	7.3	0.2385	7.75	0.06325	0	0.08475	4.88	0.10625	1.78
0.228	7.3	0.23875	7.75	0.06375	0	0.08525	4.44	0.10675	1.78
0.22825	7.3	0.239	7.97	0.06425	0.222	0.08575	3.77	0.10725	1.78
0.2285	7.52	0.23925	7.97	0.06475	0.222	0.08625	3.55	0.10775	1.78
0.22875	7.3	0.2395	7.97	0.06525	0	0.08675	3.11	0.10825	1.78
0.229	7.75	0.23975	8.19	0.06575	0	0.08725	3.33	0.10875	2
0.22925	7.52	0.24	8.19	0.06625	0	0.08775	3.55	0.10925	2
0.2295	7.08	0.24025	8.41	0.06675	0.222	0.08825	3.33	0.10975	2
0.22975	7.3	0.2405	8.41	0.06725	0.222	0.08875	3.11	0.11025	2.22
0.23	7.52	0.24075	8.41	0.06775	0.222	0.08925	3.55	0.11075	2.44
0.23025	7.08	0.241	8.19	0.06825	0	0.08975	3.77	0.11125	2.22
0.2305	7.08	0.24125	8.63	0.06875	0.222	0.09025	3.77	0.11175	2
0.23075	7.08	0.2415	8.85	0.06925	0	0.09075	4	0.11225	2
0.231	6.86	0.24175	8.63	0.06975	0.444	0.09125	3.77	0.11275	2
0.23125	6.86	0.242	8.63	0.07025	0.444	0.09175	3.77	0.11325	2
0.2315	6.64	0.24225	8.63	0.07075	0.222	0.09225	3.33	0.11375	1.78
0.23175	6.86	0.2425	8.63	0.07125	0.222	0.09275	2.89	0.11425	1.78
0.232	6.86	0.24275	7.3	0.07175	0.444	0.09325	2.66	0.11475	1.55
0.23225	6.64	0.24375	10.17	0.07225	0.444	0.09375	2.22	0.11525	1.78
0.2325	6.86	0.244	10.17	0.07275	0.889	0.09425	2	0.11575	1.55
0.23275	6.86	0.24425	9.51	0.07325	1.55	0.09475	2	0.11625	1.78
0.233	6.86	0.2445	8.41	0.07375	1.78	0.09525	2.22	0.11675	1.78
0.23325	6.64	0.24475	7.97	0.07425	2.66	0.09575	2.22	0.11725	1.78
0.2335	6.64	0.245	6.42	0.07475	3.11	0.09625	2.22	0.11775	1.55
0.23375	6.64			0.07525	4.44	0.09675	2	0.11825	2
0.234	6.86			0.07575	6.21	0.09725	2	0.11875	1.78
0.23425	6.64			0.07625	7.98	0.09775	2	0.11925	1.78
0.2345	6.86			0.07675	8.87	0.09825	1.78	0.11975	1.78
0.23475	6.86			0.07725	9.09	0.09875	1.78	0.12025	2
0.235	6.86			0.07775	8.2	0.09925	2	0.12075	2.22
0.23525	6.86			0.07825	7.1	0.09975	1.78	0.12125	2
0.2355	6.86			0.07875	6.21	0.10025	2	0.12175	2.22
0.23575	6.86			0.07925	5.55	0.10075	1.78	0.12225	2.22
0.236	7.08			0.07975	5.33	0.10125	1.55	0.12275	2.44
0.23625	7.08			0.08025	4.88	0.10175	1.55	0.12325	2.22
0.2365	7.08			0.08075	4.44	0.10225	1.78	0.12375	2.22
0.23675	7.08			0.08125	4.22	0.10275	1.55	0.12425	2.66

Gauge11_3 Time msec	Gauge11_3 Stress MPa	Gauge11_3 Time msec	Gauge11_3 Stress MPa	Gauge11_3 Time msec	Gauge11_3 Stress MPa	Gauge11_3 Time msec	Gauge11_3 Stress MPa	Gauge11_3 Time msec	Gauge11_3 Stress MPa
0.12475	2.44	0.14625	2.89	0.16775	2.44	0.18925	1.78	0.21075	1.55
0.12525	2.66	0.14675	2.89	0.16825	2.89	0.18975	1.78	0.21125	1.11
0.12575	2.66	0.14725	2.66	0.16875	2.89	0.19025	2	0.21175	1.11
0.12625	2.66	0.14775	2.66	0.16925	2.66	0.19075	2.22	0.21225	1.11
0.12675	2.66	0.14825	2.66	0.16975	2.66	0.19125	2	0.21275	1.11
0.12725	2.66	0.14875	2.44	0.17025	2.44	0.19175	2.22	0.21325	1.11
0.12775	2.66	0.14925	2.22	0.17075	2.66	0.19225	2.22	0.21375	1.11
0.12825	2.89	0.14975	2.22	0.17125	2.66	0.19275	2.22	0.21425	1.33
0.12875	2.89	0.15025	2.44	0.17175	2.89	0.19325	2.22	0.21475	1.11
0.12925	2.89	0.15075	2.22	0.17225	2.89	0.19375	2.44	0.21525	1.11
0.12975	2.66	0.15125	2	0.17275	2.89	0.19425	2.22	0.21575	1.11
0.13025	2.66	0.15175	1.78	0.17325	2.66	0.19475	2.44	0.21625	1.11
0.13075	2.89	0.15225	1.78	0.17375	2.89	0.19525	2.44	0.21675	1.11
0.13125	2.66	0.15275	2.22	0.17425	2.66	0.19575	2.44	0.21725	1.11
0.13175	2.66	0.15325	2	0.17475	2.22	0.19625	2.44	0.21775	1.11
0.13225	2.89	0.15375	2	0.17525	2.44	0.19675	2.44	0.21825	1.11
0.13275	2.89	0.15425	2.22	0.17575	2	0.19725	2	0.21875	1.11
0.13325	2.89	0.15475	2	0.17625	1.78	0.19775	2.22	0.21925	1.11
0.13375	2.89	0.15525	2	0.17675	2	0.19825	2	0.21975	1.11
0.13425	2.89	0.15575	2	0.17725	2	0.19875	2.22	0.22025	1.11
0.13475	2.89	0.15625	1.55	0.17775	2	0.19925	2	0.22075	1.11
0.13525	2.89	0.15675	1.55	0.17825	1.78	0.19975	2	0.22125	0.889
0.13575	2.89	0.15725	1.55	0.17875	1.55	0.20025	2	0.22175	0.889
0.13625	3.11	0.15775	1.33	0.17925	1.55	0.20075	2	0.22225	1.11
0.13675	2.89	0.15825	1.33	0.17975	1.78	0.20125	1.78	0.22275	0.889
0.13725	2.89	0.15875	1.55	0.18025	1.55	0.20175	2	0.22325	1.11
0.13775	3.11	0.15925	1.33	0.18075	1.78	0.20225	1.55	0.22375	0.889
0.13825	3.11	0.15975	1.55	0.18125	1.78	0.20275	1.78	0.22425	1.11
0.13875	3.11	0.16025	1.55	0.18175	1.55	0.20325	1.78	0.22475	0.889
0.13925	2.89	0.16075	1.55	0.18225	1.78	0.20375	1.55	0.22525	0.889
0.13975	2.89	0.16125	1.55	0.18275	1.55	0.20425	1.78	0.22575	0.889
0.14025	2.89	0.16175	1.55	0.18325	1.78	0.20475	1.78	0.22625	1.11
0.14075	2.66	0.16225	1.78	0.18375	1.55	0.20525	1.78	0.22675	1.11
0.14125	2.66	0.16275	1.78	0.18425	1.33	0.20575	1.78	0.22725	1.11
0.14175	2.66	0.16325	1.78	0.18475	1.78	0.20625	1.55	0.22775	0.222
0.14225	2.66	0.16375	2	0.18525	1.78	0.20675	1.78	0.22825	1.11
0.14275	2.66	0.16425	2	0.18575	1.78	0.20725	1.78	0.22875	1.33
0.14325	2.66	0.16475	2.22	0.18625	1.78	0.20775	1.78	0.22925	1.33
0.14375	2.66	0.16525	2	0.18675	2	0.20825	1.55	0.22975	1.55
0.14425	2.44	0.16575	2.22	0.18725	2	0.20875	1.55	0.23025	1.55
0.14475	2.44	0.16625	2	0.18775	2	0.20925	1.33	0.23075	1.55
0.14525	2.66	0.16675	2.44	0.18825	1.78	0.20975	1.55	0.23125	1.55
0.14575	2.66	0.16725	2.44	0.18875	2	0.21025	1.33	0.23175	2.22

Gauge11_3 Time msec	Gauge11_3 Stress MPa	Gauge11_4 Time msec	Gauge11_4 Stress MPa	Gauge11_4 Time msec	Gauge11_4 Stress MPa	Gauge11_4 Time msec	Gauge11_4 Stress MPa	Gauge11_4 Time msec	Gauge11_4 Stress MPa
0.23225	2.22	0.12225	0.223	0.14375	5.56	0.16525	3.11	0.18675	1.34
0.23275	2.44	0.12275	0.223	0.14425	4.89	0.16575	3.11	0.18725	1.11
0.23325	2.66	0.12325	0.445	0.14475	4.45	0.16625	2.89	0.18775	1.11
0.23375	2.66	0.12375	0	0.14525	4.23	0.16675	2.89	0.18825	0.89
0.23425	3.11	0.12425	0.223	0.14575	4	0.16725	3.11	0.18875	0.89
0.23475	2.66	0.12475	0.223	0.14625	4	0.16775	2.89	0.18925	0.89
0.23525	2.89	0.12525	0	0.14675	4	0.16825	2.67	0.18975	0.89
0.23575	3.11	0.12575	0.223	0.14725	4	0.16875	2.45	0.19025	0.89
0.23625	3.11	0.12625	0.223	0.14775	4	0.16925	2.23	0.19075	0.89
0.23675	3.11	0.12675	0	0.14825	3.78	0.16975	2.23	0.19125	0.89
0.23725	2.89	0.12725	0.223	0.14875	3.78	0.17025	2.45	0.19175	1.11
0.23775	2.89	0.12775	0	0.14925	3.56	0.17075	2.67	0.19225	0.89
0.23825	3.11	0.12825	0.223	0.14975	3.56	0.17125	2.45	0.19275	0.89
0.23875	2.89	0.12875	0.223	0.15025	3.56	0.17175	2.23	0.19325	0.89
0.23925	3.11	0.12925	0	0.15075	3.34	0.17225	2.45	0.19375	0.89
0.23975	3.11	0.12975	0.223	0.15125	3.34	0.17275	2	0.19425	1.11
0.24025	3.11	0.13025	0	0.15175	3.11	0.17325	2	0.19475	0.89
0.24075	2.89	0.13075	-0.223	0.15225	3.11	0.17375	2	0.19525	1.11
0.24125	2.66	0.13125	0	0.15275	3.11	0.17425	1.78	0.19575	0.89
0.24175	2.66	0.13175	-0.223	0.15325	3.11	0.17475	1.56	0.19625	0.89
0.24225	2.66	0.13225	-0.223	0.15375	3.11	0.17525	1.78	0.19675	1.11
0.24275	2.44	0.13275	0	0.15425	3.34	0.17575	1.78	0.19725	1.11
0.24325	2.89	0.13325	-0.223	0.15475	3.34	0.17625	1.78	0.19775	1.11
0.24375	3.11	0.13375	-0.223	0.15525	3.34	0.17675	1.78	0.19825	0.89
0.24425	3.11	0.13425	0	0.15575	3.34	0.17725	1.78	0.19875	0.89
0.24475	2.89	0.13475	-0.223	0.15625	3.34	0.17775	1.78	0.19925	0.445
0.24525	3.33	0.13525	0	0.15675	3.34	0.17825	1.56	0.19975	0.89
0.24575	2.66	0.13575	0	0.15725	3.34	0.17875	1.78	0.20025	0.445
0.24625	3.33	0.13625	0	0.15775	3.34	0.17925	1.78	0.20075	0.668
0.24675	2.89	0.13675	0.223	0.15825	3.11	0.17975	1.78	0.20125	0.445
0.24725	2.66	0.13725	0	0.15875	3.11	0.18025	2	0.20175	0.445
0.24775	2.22	0.13775	-0.223	0.15925	3.11	0.18075	1.78	0.20225	0.668
0.24825	2.22	0.13825	0.223	0.15975	3.11	0.18125	1.78	0.20275	0.668
0.24875	2.22	0.13875	0.223	0.16025	3.11	0.18175	1.56	0.20325	0.668
0.24925	2.44	0.13925	0.668	0.16075	3.34	0.18225	1.34	0.20375	0.668
0.24975	2.22	0.13975	1.11	0.16125	3.34	0.18275	1.34	0.20425	0.89
0.25025	2.66	0.14025	2	0.16175	3.11	0.18325	1.34	0.20475	0.445
0.25075	2.66	0.14075	3.11	0.16225	3.11	0.18375	1.34	0.20525	0.668
0.25125	2.22	0.14125	4.23	0.16275	3.11	0.18425	1.11	0.20575	0.668
0.25175	1.33	0.14175	4.89	0.16325	2.89	0.18475	1.34	0.20625	0.668
0.25225	2.22	0.14225	5.78	0.16375	3.11	0.18525	1.34	0.20675	0.668
0.25275	2.22	0.14275	6.45	0.16425	3.34	0.18575	1.56	0.20725	0.668
0.25325	2	0.14325	6	0.16475	3.34	0.18625	1.34	0.20775	0.668

Gauge11_4 Time msec	Gauge11_4 Stress MPa	Gauge11_4 Time msec	Gauge11_4 Stress MPa	Gauge11_6 Time msec	Gauge11_6 Stress MPa	Gauge11_6 Time msec	Gauge11_6 Stress MPa	Gauge11_6 Time msec	Gauge11_6 Stress MPa	Gauge11_6 Time msec	Gauge11_6 Stress MPa
0.20825	0.668	0.22975	1.11	0.18425	0	0.20575	0	0.22725	5.51	0.24875	9.47
0.20875	0.668	0.23025	1.11	0.18475	-0.221	0.20625	0	0.22775	5.51	0.24925	8.82
0.20925	0.445	0.23075	1.11	0.18525	0	0.20675	0	0.22825	5.74	0.24975	9.04
0.20975	0.445	0.23125	0.89	0.18575	0	0.20725	0	0.22875	6.4	0.25025	9.04
0.21025	0.445	0.23175	1.11	0.18625	0	0.20775	-0.221	0.22925	7.06	0.25075	9.04
0.21075	0.445	0.23225	1.11	0.18675	-0.221	0.20825	0	0.22975	7.72	0.25125	9.04
0.21125	0.223	0.23275	1.34	0.18725	-0.221	0.20875	0.221	0.23025	8.16	0.25175	8.82
0.21175	0.223	0.23325	1.34	0.18775	0	0.20925	0.221	0.23075	8.38	0.25225	8.82
0.21225	0.445	0.23375	1.34	0.18825	-0.221	0.20975	0	0.23125	8.82	0.25275	8.82
0.21275	0.445	0.23425	1.34	0.18875	-0.221	0.21025	-0.221	0.23175	9.04	0.25325	9.04
0.21325	0.668	0.23475	1.34	0.18925	-0.221	0.21075	0.221	0.23225	9.26	0.25375	7.94
0.21375	0.668	0.23525	1.56	0.18975	0.221	0.21125	0	0.23275	9.47	0.25425	8.82
0.21425	0.445	0.23575	1.56	0.19025	-0.221	0.21175	-0.221	0.23325	9.69	0.25475	4.85
0.21475	0.223	0.23625	1.56	0.19075	-0.221	0.21225	0	0.23375	9.69	0.25525	2.65
0.21525	0.445	0.23675	1.56	0.19125	0	0.21275	0.221	0.23425	9.91	0.25575	0.884
0.21575	0.445	0.23725	1.56	0.19175	0	0.21325	0.221	0.23475	9.91	0.25625	-0.663
0.21625	0.445	0.23775	1.56	0.19225	0	0.21375	0	0.23525	10.13	0.25675	-1.99
0.21675	0.445	0.23825	1.56	0.19275	0	0.21425	0	0.23575	10.13	0.25725	-2.87
0.21725	0.668	0.23875	1.56	0.19325	0	0.21475	0.221	0.23625	10.13	0.25775	-3.32
0.21775	0.668	0.23925	1.56	0.19375	0	0.21525	0.221	0.23675	10.35	0.25825	-3.76
0.21825	0.668	0.23975	1.56	0.19425	-0.442	0.21575	0.221	0.23725	10.35		
0.21875	0.668	0.24025	1.78	0.19475	-0.442	0.21625	0.442	0.23775	10.57		
0.21925	0.668	0.24075	1.78	0.19525	0	0.21675	0.442	0.23825	10.35		
0.21975	0.89	0.24125	1.56	0.19575	0.221	0.21725	0.442	0.23875	10.57		
0.22025	0.89	0.24175	1.56	0.19625	0	0.21775	0.663	0.23925	10.79		
0.22075	0.668	0.24225	1.56	0.19675	0	0.21825	0.442	0.23975	11.01		
0.22125	0.668	0.24275	1.34	0.19725	-0.221	0.21875	0.884	0.24025	11.01		
0.22175	0.668	0.24325	1.11	0.19775	0	0.21925	0.663	0.24075	11.01		
0.22225	0.668	0.24375	0.89	0.19825	0	0.21975	0.884	0.24125	11.01		
0.22275	0.89	0.24425	1.11	0.19875	-0.221	0.22025	1.55	0.24175	11.01		
0.22325	1.11	0.24475	1.34	0.19925	0	0.22075	1.55	0.24225	11.01		
0.22375	0.668	0.24525	2.23	0.19975	0	0.22125	1.77	0.24275	10.79		
0.22425	0.89	0.24575	0.89	0.20025	-0.221	0.22175	2.21	0.24325	10.35		
0.22475	0.668	0.24625	1.34	0.20075	0	0.22225	2.65	0.24375	10.79		
0.22525	0.668	0.24675	0.668	0.20125	-0.221	0.22275	3.09	0.24425	10.79		
0.22575	0.668	0.24725	1.11	0.20175	-0.221	0.22325	3.53	0.24475	10.35		
0.22625	0.668			0.20225	0	0.22375	3.97	0.24525	10.13		
0.22675	0.89			0.20275	-0.221	0.22425	4.19	0.24575	8.82		
0.22725	0.668			0.20325	0	0.22475	4.41	0.24625	9.04		
0.22775	0.668			0.20375	-0.221	0.22525	4.85	0.24675	8.6		
0.22825	0.89			0.20425	-0.221	0.22575	4.85	0.24725	9.69		
0.22875	0.89			0.20475	-0.221	0.22625	4.85	0.24775	9.91		
0.22925	0.89			0.20525	0	0.22675	5.29	0.24825	9.69		

Gauge13_1 Time msec	Gauge13_1 Stress MPa	Gauge13_1 Time msec	Gauge13_1 Stress MPa	Gauge13_1 Time msec	Gauge13_1 Stress MPa	Gauge13_1 Time msec	Gauge13_1 Stress MPa	Gauge13_1 Time msec	Gauge13_1 Stress MPa
-0.0095	0	0.00125	728.28	0.012	0	0.02275	34.52	0.0335	0
-0.00925	-17.52	0.0015	1073.11	0.01225	0	0.023	58.19	0.03375	0
-0.009	0	0.00175	1118.48	0.0125	0	0.02325	58.19	0.034	-17.52
-0.00875	17.35	0.002	1118.48	0.01275	0	0.0235	90.96	0.03425	-17.52
-0.0085	0	0.00225	1118.48	0.013	-35.21	0.02375	58.19	0.0345	-17.52
-0.00825	-17.52	0.0025	1028.08	0.01325	-17.52	0.024	58.19	0.03475	-17.52
-0.008	-17.52	0.00275	939.28	0.0135	-35.21	0.02425	58.19	0.035	0
-0.00775	0	0.003	852.68	0.01375	-35.21	0.0245	34.52	0.03525	0
-0.0075	0	0.00325	810.4	0.014	-17.52	0.02475	17.35	0.0355	0
-0.00725	0	0.0035	507.16	0.01425	-17.52	0.025	58.19	0.03575	0
-0.007	0	0.00375	261.35	0.0145	0	0.02525	58.19	0.036	0
-0.00675	0	0.004	194.16	0.01475	17.35	0.0255	90.96	0.03625	0
-0.0065	0	0.00425	90.96	0.015	34.52	0.02575	120.1	0.0365	-17.52
-0.00625	-17.52	0.0045	90.96	0.01525	17.35	0.026	120.1	0.03675	0
-0.006	-17.52	0.00475	34.52	0.0155	17.35	0.02625	146.5	0.037	-17.52
-0.00575	0	0.005	34.52	0.01575	0	0.0265	146.5	0.03725	-35.21
-0.0055	0	0.00525	0	0.016	-17.52	0.02675	146.5	0.0375	0
-0.00525	0	0.0055	-61.39	0.01625	-35.21	0.027	146.5	0.03775	-17.52
-0.005	0	0.00575	-127.25	0.0165	-17.52	0.02725	146.5	0.038	-17.52
-0.00475	0	0.006	-156.04	0.01675	0	0.0275	146.5	0.03825	-17.52
-0.0045	-17.52	0.00625	-183.28	0.017	0	0.02775	146.5	0.0385	0
-0.00425	0	0.0065	-183.28	0.01725	17.35	0.028	146.5	0.03875	0
-0.004	0	0.00675	-156.04	0.0175	0	0.02825	146.5	0.039	0
-0.00375	0	0.007	-127.25	0.01775	-17.52	0.0285	120.1	0.03925	0
-0.0035	0	0.00725	-127.25	0.018	-35.21	0.02875	120.1	0.0395	0
-0.00325	0	0.0075	-96.02	0.01825	-35.21	0.029	120.1	0.03975	0
-0.003	0	0.00775	-61.39	0.0185	0	0.02925	90.96	0.04	0
-0.00275	0	0.008	-96.02	0.01875	0	0.0295	90.96	0.04025	0
-0.0025	0	0.00825	-96.02	0.019	0	0.02975	90.96	0.0405	0
-0.00225	0	0.0085	-96.02	0.01925	0	0.03	90.96	0.04075	-17.52
-0.002	0	0.00875	-96.02	0.0195	0	0.03025	58.19	0.041	0
-0.00175	-17.52	0.009	-96.02	0.01975	-17.52	0.0305	58.19	0.04125	0
-0.0015	0	0.00925	-96.02	0.02	-17.52	0.03075	34.52	0.0415	0
-0.00125	0	0.0095	-35.21	0.02025	0	0.031	34.52	0.04175	-17.52
-0.001	0	0.00975	-35.21	0.0205	0	0.03125	17.35	0.042	-17.52
-0.00075	-17.52	0.01	-35.21	0.02075	-17.52	0.0315	34.52	0.04225	0
-0.0005	0	0.01025	-17.52	0.021	-35.21	0.03175	17.35	0.0425	-17.52
-0.00025	0	0.0105	-35.21	0.02125	-17.52	0.032	17.35	0.04275	0
0	0	0.01075	0	0.0215	0	0.03225	17.35	0.043	-17.52
0.00025	17.35	0.011	-17.52	0.02175	17.35	0.0325	17.35	0.04325	-17.52
0.0005	170.97	0.01125	0	0.022	34.52	0.03275	17.35	0.0435	0
0.00075	284.29	0.0115	0	0.02225	34.52	0.033	0	0.04375	0
0.001	413.88	0.01175	0	0.0225	58.19	0.03325	-17.52	0.044	-35.21

Gauge13_2 Time msec	Gauge13_2 Stress MPa	Gauge13_2 Time msec	Gauge13_2 Stress MPa	Gauge13_2 Time msec	Gauge13_2 Stress MPa	Gauge13_2 Time msec	Gauge13_2 Stress MPa	Gauge13_3 Time msec	Gauge13_3 Stress MPa
-0.02325	-0.62	-0.00175	0	0.01975	-0.413	0.04125	-0.413	0.03275	-0.112
-0.02275	-1.03	-0.00125	-0.103	0.02025	-0.207	0.04175	-0.207	0.033	-0.112
-0.02225	-0.723	-0.00075	0	0.02075	-0.103	0.04225	-0.31	0.03325	-0.112
-0.02175	-0.31	-0.00025	-0.103	0.02125	0	0.04325	-0.413	0.0335	-0.112
-0.02125	0	0.00025	-0.103	0.02175	-0.103	0.04375	-0.517	0.03375	-0.224
-0.02075	-0.103	0.00075	0.103	0.02225	0.103	0.04425	-0.62	0.034	-0.224
-0.02025	-0.103	0.00125	0.103	0.02275	0	0.04475	-1.45	0.03425	-0.224
-0.01975	-0.207	0.00175	0.103	0.02325	0.207	0.04525	-0.62	0.0345	-0.224
-0.01925	-0.103	0.00225	-0.103	0.02375	-0.103	0.04575	-0.413	0.03475	-0.224
-0.01875	0.103	0.00275	0.207	0.02425	0.103	0.04625	-1.55	0.035	0
-0.01825	0	0.00325	-0.31	0.02475	-0.103	0.04675	-0.93	0.03525	-0.112
-0.01775	-0.103	0.00375	0.93	0.02525	0	0.04725	0.207	0.0355	0
-0.01725	-0.207	0.00425	-0.62	0.02575	0.103	0.04775	-1.24	0.03575	0
-0.01675	-0.207	0.00475	-0.517	0.02625	0	0.04825	-0.827	0.036	-0.224
-0.01625	-0.207	0.00525	-0.413	0.02675	0.103	0.04875	1.34	0.03625	-0.224
-0.01575	-0.207	0.00575	-0.103	0.02725	0.103	0.04925	-0.31	0.0365	-0.224
-0.01525	0.103	0.00625	0.207	0.02775	0.207	0.04975	-0.517	0.03675	-0.112
-0.01475	0	0.00675	0.103	0.02825	0.207	0.05025	-0.723	0.037	-0.112
-0.01425	-0.103	0.00725	-0.103	0.02875	0.103	0.05075	-0.62	0.03725	-0.112
-0.01375	0	0.00775	-0.413	0.02925	0.103	0.05125	-0.517	0.0375	-0.112
-0.01325	0	0.00825	-0.207	0.02975	0.103	0.05175	-0.62	0.03775	-0.224
-0.01275	0	0.00875	-0.207	0.03025	0.207	0.05225	-0.723	0.038	-0.112
-0.01225	0	0.00925	-0.31	0.03075	0.103	0.05275	-0.62	0.03825	0
-0.01175	0	0.00975	-0.517	0.03125	0.103	0.05325	-0.517	0.0385	-0.112
-0.01125	0	0.01025	-0.31	0.03175	0	0.05375	-0.413	0.03875	-0.112
-0.01075	0	0.01075	-0.207	0.03225	0.103	0.05425	-0.207	0.039	0
-0.01025	-0.103	0.01125	-0.103	0.03275	0.103	0.05475	-0.413	0.03925	0
-0.00975	0	0.01175	-0.207	0.03325	0.103	0.05525	-0.31	0.0395	-0.112
-0.00925	0.103	0.01225	-0.207	0.03375	0	0.05575	-0.31	0.03975	-0.112
-0.00875	0	0.01275	-0.31	0.03425	-0.103	0.05625	-0.31	0.04	-0.112
-0.00825	0	0.01325	-0.103	0.03475	0	0.05675	-0.207	0.04025	0
-0.00775	0.103	0.01375	0.103	0.03525	0	0.05725	-0.31	0.0405	-0.112
-0.00725	0	0.01425	-0.413	0.03575	0	0.05775	-0.207	0.04075	0
-0.00675	0	0.01475	-0.31	0.03625	-0.103	0.05825	-0.31	0.041	0
-0.00625	0	0.01525	-0.31	0.03675	0	0.05875	-0.62	0.04125	0
-0.00575	0	0.01575	-0.103	0.03725	-0.207	0.05925	-0.62	0.0415	0
-0.00525	0	0.01625	-0.31	0.03775	-0.517	0.05975	-0.827	0.04175	0
-0.00475	0	0.01675	-0.207	0.03825	-0.413	0.06025	-1.03	0.042	0.112
-0.00425	0.103	0.01725	-0.207	0.03875	-0.517	0.06075	-1.55	0.04225	0
-0.00375	0.103	0.01775	-0.103	0.03925	-0.31	0.06125	-2.07	0.0425	0
-0.00325	0	0.01825	-0.207	0.03975	-0.31	0.06175	0	0.04275	0
-0.00275	0.103	0.01875	-0.207	0.04025	-0.31	0.06225	0	0.043	-0.112
-0.00225	0	0.01925	-0.207	0.04075	-0.413	0.06275	0	0.04325	0

Gauge 13_3 Time msec	Gauge 13_3 Stress MPa	Gauge 13_3 Time msec	Gauge 13_3 Stress MPa	Gauge 13_4 Time msec	Gauge 13_4 Stress MPa	Gauge 13_4 Time msec	Gauge 13_4 Stress MPa	Gauge 13_4 Time msec	Gauge 13_4 Stress MPa
0.0435	0	0.05425	0	0.07175	0	0.0825	0	0.09325	-0.055
0.04375	0	0.0545	0	0.072	-0.055	0.08275	-0.055	0.0935	-0.055
0.044	0	0.05475	-0.112	0.07225	0	0.083	0	0.09375	0
0.04425	0	0.055	0	0.0725	0	0.08325	0	0.094	0.055
0.0445	0.112	0.05525	-0.112	0.07275	0	0.0835	0	0.09425	-0.055
0.04475	0	0.0555	0.112	0.073	-0.055	0.08375	-0.055	0.0945	0
0.045	0.224	0.05575	0	0.07325	-0.055	0.084	-0.055	0.09475	0.055
0.04525	0	0.056	0.112	0.0735	-0.055	0.08425	-0.055	0.095	0
0.0455	0.112	0.05625	0.112	0.07375	0	0.0845	0	0.09525	-0.055
0.04575	0	0.0565	0.112	0.074	0	0.08475	-0.055	0.0955	0
0.046	0	0.05675	0.224	0.07425	-0.055	0.085	0	0.09575	0.055
0.04625	0.112	0.057	0	0.0745	0	0.08525	0	0.096	-0.055
0.0465	0	0.05725	0	0.07475	-0.055	0.0855	0.055	0.09625	0
0.04675	0.224	0.0575	0	0.075	-0.055	0.08575	-0.055	0.0965	0
0.047	-0.112	0.05775	0	0.07525	0	0.086	-0.055	0.09675	0
0.04725	0	0.058	0.112	0.0755	0	0.08625	-0.055	0.097	0
0.0475	0.224	0.05825	0.224	0.07575	-0.055	0.0865	0	0.09725	0
0.04775	0.112	0.0585	0.224	0.076	-0.055	0.08675	-0.055	0.0975	0
0.048	-0.112	0.05875	0.336	0.07625	0	0.087	-0.055	0.09775	0
0.04825	0	0.059	0.448	0.0765	0	0.08725	0	0.098	0.055
0.0485	0	0.05925	0.448	0.07675	-0.055	0.0875	0	0.09825	0
0.04875	-0.336	0.0595	0.448	0.077	0.055	0.08775	-0.055	0.0985	0
0.049	-0.112	0.05975	0.672	0.07725	-0.055	0.088	0.055	0.09875	0
0.04925	-0.224	0.06	1.01	0.0775	0	0.08825	-0.055	0.099	0
0.0495	0	0.06025	1.46	0.07775	0	0.0885	-0.055	0.09925	-0.055
0.04975	0	0.0605	1.9	0.078	0	0.08875	-0.055	0.0995	0
0.05	0	0.06075	2.91	0.07825	0	0.089	0	0.09975	0
0.05025	0	0.061	4.14	0.0785	0	0.08925	-0.111	0.1	0
0.0505	0	0.06125	5.59	0.07875	0.055	0.0895	0	0.10025	0
0.05075	0.112	0.0615	7.26	0.079	0	0.08975	-0.055	0.1005	0
0.051	0.112	0.06175	9.27	0.07925	0	0.09	-0.055	0.10075	0.055
0.05125	0	0.062	10.61	0.0795	-0.055	0.09025	-0.055	0.101	0
0.0515	0.112	0.06225	9.6	0.07975	-0.055	0.0905	0	0.10125	0
0.05175	0.112	0.0625	7.93	0.08	-0.055	0.09075	-0.055	0.1015	0
0.052	0	0.06275	6.26	0.08025	0	0.091	-0.055	0.10175	-0.055
0.05225	0.112	0.063	1.68	0.0805	0	0.09125	-0.055	0.102	0.055
0.0525	-0.112	0.06325	-7.18	0.08075	0	0.0915	0	0.10225	0
0.05275	0.112	0.0635	-13.49	0.081	0	0.09175	0	0.1025	0.055
0.053	0.224	0.06375	-13.49	0.08125	0	0.092	-0.055	0.10275	0.111
0.05325	0.112	0.064	-13.49	0.0815	0	0.09225	-0.055	0.103	0.055
0.0535	0.112	0.06425	-13.49	0.08175	0	0.0925	-0.111	0.10325	0
0.05375	0.112			0.082	0	0.09275	-0.111	0.1035	0.055
0.054	-0.112			0.08225	0	0.093	0	0.10375	0.055

Gauge 13_4 Time msec	Gauge 13_4 Stress MPa	Gauge 13_4 Time msec	Gauge 13_4 Stress MPa	Gauge 13_4 Time msec	Gauge 13_4 Stress MPa	Gauge 13_4 Time msec	Gauge 13_4 Stress MPa	Gauge 13_4 Time msec	Gauge 13_4 Stress MPa
0.104	0.055	0.11475	0.166	0.1255	1.94	0.13625	3.59	0.147	5.42
0.10425	0.055	0.115	0.221	0.12575	1.99	0.1365	4.42	0.14725	5.47
0.1045	0.055	0.11525	0.166	0.126	2.05	0.13675	5.53	0.1475	5.53
0.10475	0.111	0.1155	0.221	0.12625	2.05	0.137	6.41	0.14775	5.53
0.105	0.111	0.11575	0.221	0.1265	2.16	0.13725	7.12	0.148	5.47
0.10525	0.055	0.116	0.221	0.12675	2.32	0.1375	7.29	0.14825	5.36
0.1055	0.111	0.11625	0.221	0.127	2.49	0.13775	7.29	0.1485	5.19
0.10575	0.111	0.1165	0.221	0.12725	2.16	0.138	7.23	0.14875	4.97
0.106	0.111	0.11675	0.221	0.1275	1.77	0.13825	7.29	0.149	4.7
0.10625	0.111	0.117	0.221	0.12775	1.6	0.1385	7.29	0.14925	4.53
0.1065	0.111	0.11725	0.221	0.128	1.88	0.13875	7.23	0.1495	4.31
0.10675	0.111	0.1175	0.221	0.12825	1.99	0.139	7.23	0.14975	4.09
0.107	0.166	0.11775	0.221	0.1285	1.88	0.13925	7.29	0.15	3.81
0.10725	0.111	0.118	0.277	0.12875	1.49	0.1395	7.29	0.15025	3.48
0.1075	0.111	0.11825	0.221	0.129	0.775	0.13975	7.29	0.1505	3.15
0.10775	0.111	0.1185	0.277	0.12925	0.941	0.14	7.23	0.15075	2.82
0.108	0.166	0.11875	0.221	0.1295	1.94	0.14025	7.29	0.151	2.54
0.10825	0.166	0.119	0.221	0.12975	2.71	0.1405	7.29	0.15125	2.21
0.1085	0.166	0.11925	0.221	0.13	2.93	0.14075	7.29	0.1515	1.88
0.10875	0.166	0.1195	0.221	0.13025	2.6	0.141	7.29	0.15175	1.77
0.109	0.166	0.11975	0.277	0.1305	2.1	0.14125	7.23	0.152	1.66
0.10925	0.166	0.12	0.332	0.13075	1.44	0.1415	7.23	0.15225	1.55
0.1095	0.111	0.12025	0.332	0.131	0.553	0.14175	7.29	0.1525	1.55
0.10975	0.166	0.1205	0.332	0.13125	-0.554	0.142	7.12	0.15275	1.6
0.11	0.166	0.12075	0.332	0.1315	-1.27	0.14225	6.3	0.153	1.66
0.11025	0.166	0.121	0.332	0.13175	-1.77	0.1425	5.53	0.15325	1.66
0.1105	0.166	0.12125	0.332	0.132	-1.77	0.14275	4.86	0.1535	1.66
0.11075	0.166	0.1215	0.332	0.13225	-1.55	0.143	4.31	0.15375	1.6
0.111	0.111	0.12175	0.387	0.1325	-1.44	0.14325	3.76	0.154	1.55
0.11125	0.166	0.122	0.332	0.13275	-1.72	0.1435	3.59	0.15425	1.55
0.1115	0.166	0.12225	0.387	0.133	-1.88	0.14375	3.59	0.1545	1.71
0.11175	0.111	0.1225	0.387	0.13325	-1.27	0.144	3.65	0.15475	1.77
0.112	0.221	0.12275	0.553	0.1335	-0.996	0.14425	3.7	0.155	1.88
0.11225	0.166	0.123	0.609	0.13375	-1.66	0.1445	3.81	0.15525	1.99
0.1125	0.166	0.12325	0.719	0.134	-1.44	0.14475	3.92	0.1555	2.05
0.11275	0.221	0.1235	0.885	0.13425	0.277	0.145	4.09	0.15575	2.16
0.113	0.221	0.12375	0.996	0.1345	1.49	0.14525	4.2	0.156	2.16
0.11325	0.166	0.124	1.16	0.13475	0.775	0.1455	4.42	0.15625	2.27
0.1135	0.221	0.12425	1.38	0.135	0.719	0.14575	4.53	0.1565	2.43
0.11375	0.166	0.1245	1.6	0.13525	1.27	0.146	4.7	0.15675	2.49
0.114	0.166	0.12475	1.77	0.1355	1.71	0.14625	4.92	0.157	2.49
0.11425	0.221	0.125	1.83	0.13575	2.16	0.1465	5.08	0.15725	2.6
0.1145	0.166	0.12525	1.83	0.136	2.93	0.14675	5.25	0.1575	2.6

Gauge13_4 Time msec	Gauge13_4 Stress MPa	Gauge13_4 Time msec	Gauge13_4 Stress MPa	Gauge13_4 Time msec	Gauge13_4 Stress MPa	Gauge13_4 Time msec	Gauge13_4 Stress MPa	Gauge13_4 Time msec	Gauge13_4 Stress MPa
0.15775	2.49	0.1685	0.664	0.17925	3.59	0.19	1.66	0.20075	-7.21
0.158	2.49	0.16875	0.553	0.1795	3.7	0.19025	1.44	0.201	-7.21
0.15825	2.27	0.169	0.387	0.17975	3.81	0.1905	-0.775	0.20125	-7.21
0.1585	2.1	0.16925	0.498	0.18	3.7	0.19075	-0.111	0.2015	-7.21
0.15875	1.99	0.1695	0.609	0.18025	3.59	0.191	1.88	0.20175	-7.21
0.159	1.71	0.16975	0.775	0.1805	4.09	0.19125	2.05	0.202	2.49
0.15925	1.55	0.17	0.996	0.18075	3.92	0.1915	1.27	0.20225	3.59
0.1595	1.38	0.17025	1.16	0.181	3.81	0.19175	1.05	0.2025	1.44
0.15975	1.22	0.1705	1.33	0.18125	3.81	0.192	5.69	0.20275	0.387
0.16	1.05	0.17075	1.49	0.1815	3.76	0.19225	6.96	0.203	-0.111
0.16025	1.05	0.171	1.71	0.18175	3.76	0.1925	4.15	0.20325	0.664
0.1605	1.11	0.17125	1.66	0.182	3.7	0.19275	2.71	0.2035	0.996
0.16075	0.996	0.1715	1.66	0.18225	3.48	0.193	2.93	0.20375	1.88
0.161	1.05	0.17175	2.32	0.1825	3.48	0.19325	5.36	0.204	2.27
0.16125	1.16	0.172	2.93	0.18275	3.48	0.1935	-0.941	0.20425	2.1
0.1615	1.16	0.17225	3.04	0.183	3.48	0.19375	0.941	0.2045	1.77
0.16175	1.27	0.1725	2.99	0.18325	3.48	0.194	4.09	0.20475	1.49
0.162	1.49	0.17275	2.93	0.1835	3.15	0.19425	5.19	0.205	1.33
0.16225	1.6	0.173	2.71	0.18375	3.04	0.1945	6.9	0.20525	1.38
0.1625	1.77	0.17325	2.43	0.184	2.88	0.19475	6.9	0.2055	1.33
0.16275	1.88	0.1735	2.71	0.18425	2.54	0.195	5.58	0.20575	1.16
0.163	1.94	0.17375	2.71	0.1845	2.6	0.19525	4.64	0.206	1.16
0.16325	1.99	0.174	2.71	0.18475	2.43	0.1955	5.03	0.20625	1.16
0.1635	1.99	0.17425	2.65	0.185	2.16	0.19575	4.31	0.2065	1.33
0.16375	2.05	0.1745	2.71	0.18525	2.27	0.196	2.76	0.20675	1.44
0.164	2.1	0.17475	2.54	0.1855	2.21	0.19625	1.6	0.207	1.22
0.16425	2.1	0.175	2.49	0.18575	2.43	0.1965	4.7	0.20725	0.996
0.1645	2.1	0.17525	5.03	0.186	2.49	0.19675	6.96	0.2075	0.885
0.16475	2.16	0.1755	4.37	0.18625	2.6	0.197	6.63	0.20775	0.941
0.165	2.27	0.17575	2.88	0.1865	2.71	0.19725	5.14	0.208	0.885
0.16525	2.27	0.176	2.82	0.18675	2.88	0.1975	4.92	0.20825	0.83
0.1655	2.27	0.17625	3.87	0.187	3.37	0.19775	6.63	0.2085	0.83
0.16575	2.32	0.1765	3.15	0.18725	2.88	0.198	6.9	0.20875	0.664
0.166	2.21	0.17675	2.6	0.1875	2.16	0.19825	6.96	0.209	0.664
0.16625	2.05	0.177	2.6	0.18775	2.38	0.1985	6.96	0.20925	0.553
0.1665	1.99	0.17725	2.71	0.188	2.27	0.19875	4.64	0.2095	0.609
0.16675	1.77	0.1775	2.88	0.18825	2.1	0.199	3.59	0.20975	0.719
0.167	1.55	0.17775	3.04	0.1885	2.32	0.19925	3.43	0.21	1.11
0.16725	1.38	0.178	3.26	0.18875	2.27	0.1995	2.88	0.21025	1.16
0.1675	1.22	0.17825	3.43	0.189	1.83	0.19975	2.99	0.2105	0.885
0.16775	1.11	0.1785	3.48	0.18925	0.941	0.2	2.82	0.21075	1.05
0.168	0.941	0.17875	3.87	0.1895	1.22	0.20025	2.54	0.211	1.16
0.16825	0.719	0.179	3.7	0.18975	1.6	0.2005	-4.54	0.21125	0.885

Gauge13_4 Time msec	Gauge13_4 Stress MPa	Gauge13_5 Time msec	Gauge13_5 Stress MPa	Gauge13_5 Time msec	Gauge13_5 Stress MPa	Gauge13_5 Time msec	Gauge13_5 Stress MPa	Gauge13_5 Time msec	Gauge13_5 Stress MPa
0.2115	0.387	0.06425	0.224	0.08575	0.336	0.10725	-0.112	0.12875	1.06
0.21175	0.332	0.06475	0.224	0.08625	0.392	0.10775	0	0.12925	1.57
0.212	0.277	0.06525	0.168	0.08675	0.392	0.10825	-0.056	0.12975	1.73
0.21225	0.387	0.06575	0.224	0.08725	0.336	0.10875	-0.056	0.13025	1.46
0.2125	0.166	0.06625	0.224	0.08775	0.28	0.10925	0.056	0.13075	2.18
0.21275	0.166	0.06675	0.224	0.08825	0.336	0.10975	0	0.13125	4.47
0.213	0.277	0.06725	0.224	0.08875	0.336	0.11025	-0.056	0.13175	3.8
0.21325	0.221	0.06775	0.224	0.08925	0.28	0.11075	0	0.13225	-3.25
0.2135	0.166	0.06825	0.168	0.08975	0.28	0.11125	0	0.13275	-4.43
0.21375	0.055	0.06875	0.168	0.09025	0.28	0.11175	0	0.13325	-4.54
0.214	0.055	0.06925	0.168	0.09075	0.28	0.11225	-0.056	0.13375	-5.16
0.21425	0.055	0.06975	0.224	0.09125	0.28	0.11275	-0.056	0.13425	-5.66
0.2145	-0.055	0.07025	0.224	0.09175	0.224	0.11325	-0.056	0.13475	-6.39
		0.07075	0.224	0.09225	0.168	0.11375	0	0.13525	-7.07
		0.07125	0.168	0.09275	0.224	0.11425	0	0.13575	-7.63
		0.07175	0.224	0.09325	0.224	0.11475	0	0.13625	-7.57
		0.07225	0.224	0.09375	0.224	0.11525	0	0.13675	-7.57
		0.07275	0.168	0.09425	0.224	0.11575	-0.056	0.13725	-7.63
		0.07325	0.224	0.09475	0.168	0.11625	-0.056	0.13775	-7.18
		0.07375	0.224	0.09525	0.168	0.11675	-0.056	0.13825	-6.45
		0.07425	0.224	0.09575	0.168	0.11725	-0.056	0.13875	-6.51
		0.07475	0.224	0.09625	0.168	0.11775	-0.056	0.13925	-6.34
		0.07525	0.224	0.09675	0.168	0.11825	-0.056	0.13975	-5.33
		0.07575	0.224	0.09725	0.168	0.11875	-0.056	0.14025	-4.6
		0.07625	0.224	0.09775	0.168	0.11925	-0.056	0.14075	-4.04
		0.07675	0.28	0.09825	0.112	0.11975	-0.056	0.14125	-3.76
		0.07725	0.28	0.09875	0.168	0.12025	-0.056	0.14175	-3.7
		0.07775	0.28	0.09925	0.168	0.12075	-0.112	0.14225	-3.76
		0.07825	0.28	0.09975	0.112	0.12125	-0.112	0.14275	-3.81
		0.07875	0.224	0.10025	0.168	0.12175	-0.112	0.14325	-4.32
		0.07925	0.28	0.10075	0.112	0.12225	-0.112	0.14375	-4.48
		0.07975	0.336	0.10125	0.056	0.12275	-0.168	0.14425	-3.92
		0.08025	0.224	0.10175	0.056	0.12325	-0.168	0.14475	-3.53
		0.08075	0.28	0.10225	0.056	0.12375	-0.168	0.14525	-3.81
		0.08125	0.28	0.10275	0.056	0.12425	-0.224	0.14575	-4.04
		0.08175	0.28	0.10325	0	0.12475	-0.224	0.14625	-4.99
		0.08225	0.28	0.10375	0	0.12525	-0.168	0.14675	-4.88
		0.08275	0.336	0.10425	0	0.12575	-0.112	0.14725	-5.78
		0.08325	0.336	0.10475	-0.056	0.12625	0	0.14775	-5.78
		0.08375	0.336	0.10525	0	0.12675	0.056	0.14825	-5.55
		0.08425	0.392	0.10575	0	0.12725	0.224	0.14875	-5.44
		0.08475	0.392	0.10625	0	0.12775	0.392	0.14925	-5.44
		0.08525	0.336	0.10675	0	0.12825	0.616	0.14975	-5.55



Gauge I3_5 Time msec	Gauge I3_5 Stress MPa	Gauge I3_6 Time msec	Gauge I3_6 Stress MPa	Gauge I3_6 Time msec	Gauge I3_6 Stress MPa	Gauge I3_6 Time msec	Gauge I3_6 Stress MPa	Gauge I3_6 Time msec	Gauge I3_6 Stress MPa	Gauge I3_6 Time msec	Gauge I3_6 Stress MPa
0.15025	-5.83	0.14175	0.068	0.1525	0.068	0.16325	0.068	0.174	-0.135	0.18475	2.57
0.15075	-6.11	0.142	0.045	0.15275	0.068	0.1635	0.068	0.17425	-0.045	0.185	2.86
0.15125	-6.34	0.14225	0.068	0.153	0.113	0.16375	0.09	0.1745	0.068	0.18525	2.99
0.15175	-6.51	0.1425	0.068	0.15325	0.068	0.164	0.068	0.17475	0.068	0.1855	2.99
0.15225	-6.56	0.14275	0	0.1535	0.068	0.16425	0.09	0.175	0.09	0.18575	2.95
0.15275	-6.62	0.143	0.068	0.15375	0.09	0.1645	0.09	0.17525	0.068	0.186	2.9
0.15325	-6.56	0.14325	0.023	0.154	0.09	0.16475	0.068	0.1755	0.023	0.18625	2.39
0.15375	-6.73	0.1435	0.068	0.15425	0.09	0.165	0.068	0.17575	-0.023	0.1865	0.158
		0.14375	0.045	0.1545	0.113	0.16525	0.068	0.176	0	0.18675	-2.73
		0.144	0.068	0.15475	0.113	0.1655	0.09	0.17625	0.045	0.187	-2.73
		0.14425	0.045	0.155	0.113	0.16575	0.068	0.1765	0.068	0.18725	-2.75
		0.1445	0.068	0.15525	0.113	0.166	0.068	0.17675	0.09	0.1875	-2.75
		0.14475	0.09	0.1555	0.113	0.16625	0.068	0.177	0.113	0.18775	-2.73
		0.145	0.09	0.15575	0.068	0.1665	0.068	0.17725	0.09	0.188	-2.75
		0.14525	0.09	0.156	0.068	0.16675	0.045	0.1775	0.068	0.18825	-2.41
		0.1455	0.09	0.15625	0.09	0.167	0.045	0.17775	0.045	0.1885	-1.85
		0.14575	0.068	0.1565	0.068	0.16725	0.023	0.178	0.023	0.18875	-2.3
		0.146	0.113	0.15675	0.045	0.1675	0	0.17825	0.023	0.189	-2.75
		0.14625	0.113	0.157	0.068	0.16775	0.023	0.1785	0.045		
		0.1465	0.113	0.15725	0.068	0.168	0.023	0.17875	0.068		
		0.14675	0.09	0.1575	0.045	0.16825	0	0.179	0.068		
		0.147	0.135	0.15775	0.045	0.1685	0.023	0.17925	0.09		
		0.14725	0.09	0.158	0.045	0.16875	0.023	0.1795	0.09		
		0.1475	0.09	0.15825	0.045	0.169	0.023	0.17975	0.068		
		0.14775	0.09	0.1585	0.068	0.16925	0.023	0.18	0.068		
		0.148	0.135	0.15875	0.068	0.1695	0.045	0.18025	0.045		
		0.14825	0.113	0.159	0.045	0.16975	0.023	0.1805	0.113		
		0.1485	0.09	0.15925	0.045	0.17	0	0.18075	0.113		
		0.14875	0.113	0.1595	0.09	0.17025	0	0.181	0.248		
		0.149	0.135	0.15975	0.068	0.1705	0.023	0.18125	0.293		
		0.14925	0.113	0.16	0.068	0.17075	-0.023	0.1815	0.338		
		0.1495	0.135	0.16025	0.045	0.171	0	0.18175	0.383		
		0.14975	0.113	0.1605	0.068	0.17125	0	0.182	0.496		
		0.15	0.113	0.16075	0.068	0.1715	-0.023	0.18225	0.608		
		0.15025	0.113	0.161	0.068	0.17175	-0.203	0.1825	0.698		
		0.1505	0.113	0.16125	0.068	0.172	-0.383	0.18275	0.878		
		0.15075	0.09	0.1615	0.068	0.17225	-0.135	0.183	1.04		
		0.151	0.09	0.16175	0.09	0.1725	0.113	0.18325	1.19		
		0.15125	0.09	0.162	0.09	0.17275	0.158	0.1835	1.35		
		0.1515	0.09	0.16225	0.09	0.173	0.045	0.18375	1.53		
		0.15175	0.09	0.1625	0.09	0.17325	-0.18	0.184	1.69		
		0.152	0.09	0.16275	0.068	0.1735	-0.203	0.18425	1.96		
		0.15225	0.068	0.163	0.09	0.17375	-0.225	0.1845	2.34		

Gauge I4_1 Time msec	Gauge I4_1 Stress MPa	Gauge I4_1 Time msec	Gauge I4_1 Stress MPa	Gauge I4_1 Time msec	Gauge I4_1 Stress MPa	Gauge I4_1 Time msec	Gauge I4_1 Stress MPa	Gauge I4_1 Time msec	Gauge I4_1 Stress MPa
-0.01275	-0.573	-0.002	0.573	0.00875	-52.49	0.0195	10.29	0.03025	41.93
-0.0125	-0.573	-0.00175	0	0.009	-98.45	0.01975	21.09	0.0305	44.17
-0.01225	-0.573	-0.0015	0.573	0.00925	-95.23	0.02	40.25	0.03075	42.49
-0.012	-0.573	-0.00125	0	0.0095	-5.17	0.02025	27.87	0.031	44.73
-0.01175	-0.573	-0.001	0.573	0.00975	15.41	0.0205	26.74	0.03125	45.28
-0.0115	-0.573	-0.00075	0.573	0.01	-0.573	0.02075	20.52	0.0315	50.98
-0.01125	-0.573	-0.0005	1.15	0.01025	-23.66	0.021	19.95	0.03175	46.21
-0.011	-0.573	-0.00025	0.573	0.0105	5.45	0.02125	18.82	0.032	39.69
-0.01075	-0.573	0	0.573	0.01075	-26.56	0.0215	28.44	0.03225	37.44
-0.0105	0	0.00025	19.39	0.011	-36.47	0.02175	39.69	0.0325	32.95
-0.01025	0	0.0005	88.36	0.01125	27.87	0.022	43.61	0.03275	30.13
-0.01	-0.573	0.00075	88.36	0.0115	6.3	0.02225	42.49	0.033	34.07
-0.00975	-0.573	0.001	89.39	0.01175	41.37	0.0225	33.51	0.03325	40.81
-0.0095	0	0.00125	88.36	0.012	0.573	0.02275	25.05	0.0335	34.07
-0.00925	0.573	0.0015	88.36	0.01225	5.72	0.023	29	0.03375	31.26
-0.009	0	0.00175	88.36	0.0125	-7.47	0.02325	39.69	0.034	23.92
-0.00875	0	0.002	88.36	0.01275	-6.89	0.0235	36.32	0.03425	22.22
-0.0085	0	0.00225	88.36	0.013	-1.15	0.02375	38	0.0345	19.95
-0.00825	-0.573	0.0025	88.36	0.01325	5.72	0.024	77.91	0.03475	18.82
-0.008	0	0.00275	88.36	0.0135	-25.4	0.02425	88.36	0.035	17.68
-0.00775	0	0.003	88.36	0.01375	-10.35	0.0245	88.36	0.03525	21.09
-0.0075	0	0.00325	88.36	0.014	40.25	0.02475	88.36	0.0355	19.39
-0.00725	0	0.0035	88.36	0.01425	31.82	0.025	80.04	0.03575	19.39
-0.007	0	0.00375	89.39	0.0145	-29.47	0.02525	88.36	0.036	6.3
-0.00675	0	0.004	88.36	0.01475	-14.39	0.0255	61.41	0.03625	13.71
-0.0065	0	0.00425	88.36	0.015	-40.57	0.02575	88.36	0.0365	10.29
-0.00625	0	0.0045	88.36	0.01525	-38.23	0.026	87.34	0.03675	15.41
-0.006	0	0.00475	88.36	0.0155	-22.49	0.02625	88.36	0.037	15.41
-0.00575	0	0.005	88.36	0.01575	-14.97	0.0265	88.36	0.03725	18.25
-0.0055	0	0.00525	77.91	0.016	-14.39	0.02675	83.19	0.0375	14.84
-0.00525	0	0.0055	88.36	0.01625	17.12	0.027	87.34	0.03775	19.39
-0.005	0.573	0.00575	25.61	0.0165	31.26	0.02725	87.34	0.038	20.52
-0.00475	0	0.006	-111.02	0.01675	23.35	0.0275	78.98	0.03825	19.39
-0.0045	0	0.00625	-109.99	0.017	-24.24	0.02775	86.31	0.0385	19.39
-0.00425	0	0.0065	-111.02	0.01725	-6.32	0.028	82.14	0.03875	18.82
-0.004	0	0.00675	-111.02	0.0175	-32.97	0.02825	73.61	0.039	18.82
-0.00375	0	0.007	-111.02	0.01775	-0.573	0.0285	56.83	0.03925	18.25
-0.0035	0	0.00725	-109.99	0.018	18.82	0.02875	45.28	0.0395	11.43
-0.00325	0.573	0.0075	-42.92	0.01825	18.25	0.029	45.28	0.03975	15.98
-0.003	0	0.00775	-11.5	0.0185	9.72	0.02925	41.37	0.04	15.41
-0.00275	0.573	0.008	-15.54	0.01875	22.22	0.0295	38.57	0.04025	18.25
-0.0025	0	0.00825	-19.02	0.019	2.86	0.02975	38	0.0405	20.52
-0.00225	0.573	0.0085	-32.39	0.01925	3.44	0.03	38	0.04075	20.52

Gauge14_1 Time msec	Gauge14_1 Stress MPa	Gauge14_2 Time msec	Gauge14_2 Stress MPa	Gauge14_2 Time msec	Gauge14_2 Stress MPa	Gauge14_2 Time msec	Gauge14_2 Stress MPa	Gauge14_2 Time msec	Gauge14_2 Stress MPa
0.041	21.65	0.00975	0.112	0.03125	0	0.05275	8.81	0.07425	3.57
0.04125	19.95	0.01025	-0.447	0.03175	0	0.05325	11.03	0.07475	4.24
0.0415	22.22	0.01075	-0.335	0.03225	-0.112	0.05375	11.03	0.07525	4.58
0.04175	24.48	0.01125	0.112	0.03275	-0.112	0.05425	8.25	0.07575	5.36
0.042	22.79	0.01175	0	0.03325	-0.112	0.05475	-5.48	0.07625	5.36
0.04225	19.95	0.01225	-0.335	0.03375	0.112	0.05525	-11.89	0.07675	5.58
0.0425	17.12	0.01275	-0.447	0.03425	0.112	0.05575	-10.76	0.07725	5.91
0.04275	14.28	0.01325	0.112	0.03475	0	0.05625	-8.63	0.07775	6.92
0.043	12.57	0.01375	0	0.03525	0	0.05675	-8.4	0.07825	7.81
0.04325	11.43	0.01425	-0.112	0.03575	0	0.05725	-5.15	0.07875	8.58
0.0435	13.14	0.01475	-0.671	0.03625	0	0.05775	-3.47	0.07925	8.58
0.04375	21.65	0.01525	-0.224	0.03675	0	0.05825	-4.14	0.07975	7.92
0.044	27.87	0.01575	-0.224	0.03725	0	0.05875	-7.95	0.08025	7.47
0.04425	35.76	0.01625	-0.559	0.03775	0	0.05925	-6.83	0.08075	6.8
0.0445	53.34	0.01675	-0.335	0.03825	0	0.05975	-5.26	0.08125	6.14
0.04475	68.14	0.01725	-0.112	0.03875	0	0.06025	-3.24	0.08175	5.02
0.045	89.39	0.01775	-0.224	0.03925	0	0.06075	-2.8	0.08225	3.8
0.04525	88.36	0.01825	-0.112	0.03975	0	0.06125	-1.12	0.08275	3.13
0.0455	89.39	0.01875	-0.335	0.04025	0.112	0.06175	-0.335	0.08325	3.01
0.04575	88.36	0.01925	-0.112	0.04075	0.112	0.06225	0.335	0.08375	2.9
0.046	88.36	0.01975	0	0.04125	-0.112	0.06275	1.68	0.08425	3.57
0.04625	88.36	0.02025	0	0.04175	0.112	0.06325	3.13	0.08475	3.01
0.0465	88.36	0.02075	-0.335	0.04225	-0.112	0.06375	4.13	0.08525	3.35
0.04675	88.36	0.02125	0	0.04275	0	0.06425	4.91	0.08575	2.68
0.047	88.36	0.02175	-0.112	0.04325	0.112	0.06475	6.25	0.08625	2.9
0.04725	88.36	0.02225	0	0.04375	0.112	0.06525	7.36	0.08675	3.46
0.0475	88.36	0.02275	-0.112	0.04425	0.112	0.06575	8.47	0.08725	3.46
0.04775	81.09	0.02325	0	0.04475	0	0.06625	9.03	0.08775	2.79
0.048	69.24	0.02375	0.112	0.04525	0.112	0.06675	8.47	0.08825	2.23
0.04825	60.27	0.02425	0.224	0.04575	0.112	0.06725	6.58	0.08875	1.56
0.0485	52.16	0.02475	0.447	0.04625	0.112	0.06775	4.8	0.08925	1.23
0.04875	47.41	0.02525	1.56	0.04675	0.112	0.06825	3.46	0.08975	0.67
0.049	48.61	0.02575	0.447	0.04725	0	0.06875	2.9	0.09025	0.224
0.04925	48.61	0.02625	0.224	0.04775	0.224	0.06925	2.35	0.09075	0
0.0495	44.17	0.02675	0.112	0.04825	0.224	0.06975	2.57	0.09125	0
0.04975	44.73	0.02725	0.335	0.04875	0.224	0.07025	2.23	0.09175	-0.335
0.05	45.28	0.02775	0.447	0.04925	0.224	0.07075	3.01	0.09225	-0.894
0.05025	43.05	0.02825	0.112	0.04975	0.335	0.07125	3.8	0.09275	-1.01
0.0505	46.21	0.02875	-0.112	0.05025	0.447	0.07175	4.24	0.09325	-0.782
0.05075	43.61	0.02925	0	0.05075	0.67	0.07225	4.13	0.09375	0
0.051	43.61	0.02975	0.112	0.05125	1.23	0.07275	4.02	0.09425	0
0.05125	43.61	0.03025	0	0.05175	2.46	0.07325	3.57	0.09475	0.894
0.0515	43.05	0.03075	0.112	0.05225	4.13	0.07375	3.57	0.09525	1.45

Gauge14_2 Time msec	Gauge14_2 Stress MPa	Gauge14_2 Time msec	Gauge14_2 Stress MPa	Gauge14_3 Time msec	Gauge14_3 Stress MPa	Gauge14_3 Time msec	Gauge14_3 Stress MPa	Gauge14_3 Time msec	Gauge14_3 Stress MPa
0.09575	2.35	0.11725	0.782	0.03175	-0.11	0.0425	0	0.05325	1.1
0.09625	3.57	0.11775	0.894	0.032	-0.11	0.04275	0.11	0.0535	1.32
0.09675	1.56	0.11825	1.23	0.03225	-0.11	0.043	0.22	0.05375	1.43
0.09725	1.9	0.11875	1.01	0.0325	-0.11	0.04325	0.11	0.054	1.65
0.09775	2.79	0.11925	1.12	0.03275	-0.11	0.0435	0.11	0.05425	2.09
0.09825	3.35	0.11975	1.12	0.033	-0.22	0.04375	0	0.0545	2.63
0.09875	3.01	0.12025	0.67	0.03325	-0.11	0.044	0	0.05475	3.29
0.09925	6.14	0.12075	0.782	0.0335	0	0.04425	0.11	0.055	4.5
0.09975	3.35	0.12125	0.559	0.03375	-0.11	0.0445	0.11	0.05525	6.03
0.10025	3.68	0.12175	0.782	0.034	0	0.04475	0.22	0.0555	7.23
0.10075	0	0.12225	0.67	0.03425	0	0.045	0.11	0.05575	7.89
0.10125	1.01	0.12275	0.782	0.0345	0	0.04525	0.11	0.056	8.33
0.10175	3.13	0.12325	1.23	0.03475	0	0.0455	0.22	0.05625	8
0.10225	0.447	0.12375	1.34	0.035	0	0.04575	0.22	0.0565	7.23
0.10275	0.782	0.12425	2.12	0.03525	0	0.046	0.11	0.05675	5.7
0.10325	-4.14	0.12475	2.68	0.0355	-0.11	0.04625	0.11	0.057	2.85
0.10375	-1.45	0.12525	-0.224	0.03575	-0.11	0.0465	0.11	0.05725	0.329
0.10425	-2.35	0.12575	0.559	0.036	-0.11	0.04675	0	0.0575	-0.989
0.10475	-2.8	0.12625	1.12	0.03625	0	0.047	0.11	0.05775	-1.43
0.10525	0.112	0.12675	0.559	0.0365	0	0.04725	0.22	0.058	-2.42
0.10575	-0.671	0.12725	1.56	0.03675	0	0.0475	0.11	0.05825	-3.3
0.10625	-6.61	0.12775	0.67	0.037	-0.11	0.04775	0.11	0.0585	-4.51
0.10675	-3.58	0.12825	0.894	0.03725	-0.11	0.048	0.11	0.05875	-5.39
0.10725	-2.8	0.12875	-0.559	0.0375	0	0.04825	0.22	0.059	-6.49
0.10775	-4.14	0.12925	-1.12	0.03775	-0.22	0.0485	0.11	0.05925	-7.04
0.10825	-4.81	0.12975	-1.34	0.038	0	0.04875	0.22	0.0595	-7.04
0.10875	-2.01	0.13025	-2.01	0.03825	0	0.049	0.22	0.05975	-6.71
0.10925	-0.671	0.13075	-1.68	0.0385	0	0.04925	0.11	0.06	-6.16
0.10975	1.12	0.13125	-1.79	0.03875	0	0.0495	0.22	0.06025	-5.39
0.11025	0.447	0.13175	-2.8	0.039	0	0.04975	0.11	0.0605	-5.06
0.11075	-1.34	0.13225	-2.8	0.03925	-0.11	0.05	0.22	0.06075	-4.73
0.11125	-1.45	0.13275	-3.24	0.0395	-0.11	0.05025	0.22	0.061	-5.17
0.11175	-3.58	0.13325	-3.8	0.03975	-0.11	0.0505	0.22	0.06125	-5.61
0.11225	-1.79	0.13375	-2.8	0.04	0	0.05075	0.329	0.0615	-5.28
0.11275	-1.12	0.13425	-3.02	0.04025	0	0.051	0.329	0.06175	-5.06
0.11325	-1.12	0.13475	-4.03	0.0405	0	0.05125	0.329	0.062	-4.73
0.11375	-0.447	0.13525	-4.36	0.04075	0	0.0515	0.329	0.06225	-4.62
0.11425	0.782	0.13575	-4.03	0.041	0.11	0.05175	0.329	0.0625	-4.18
0.11475	0.224	0.13625	-3.69	0.04125	0	0.052	0.439	0.06275	-4.18
0.11525	0.559	0.13675	-2.46	0.0415	0	0.05225	0.549	0.063	-4.4
0.11575	1.9	0.13725	-2.68	0.04175	0	0.0525	0.769	0.06325	-4.4
0.11625	0.782	0.13775	-2.46	0.042	0.11	0.05275	0.988	0.0635	-4.18
0.11675	1.23	0.13825	-1.68	0.04225	0	0.053	0.988	0.06375	-3.85

Gauge14_3	Gauge14_3	Gauge14_3	Gauge14_3	Gauge14_3	Gauge14_3	Gauge14_3	Gauge14_3	Gauge14_3	Gauge14_3
Time	Stress	Time	Stress	Time	Stress	Time	Stress	Time	Stress
msec	MPa	msec	MPa	msec	MPa	msec	MPa	msec	MPa
0.064	-3.3	0.07475	-1.87	0.0855	-6.49	0.09625	-4.4	0.107	-7.37
0.06425	-2.97	0.075	-1.76	0.08575	-6.38	0.0965	-4.4	0.10725	-6.49
0.0645	-2.97	0.07525	-0.989	0.086	-6.27	0.09675	-4.62	0.1075	-6.6
0.06475	-2.53	0.0755	-0.549	0.08625	-5.94	0.097	-4.62	0.10775	-6.82
0.065	-1.98	0.07575	0	0.0865	-5.83	0.09725	-4.51	0.108	-6.71
0.06525	-1.54	0.076	0.22	0.08675	-5.72	0.0975	-4.73	0.10825	-6.6
0.0655	-1.21	0.07625	0.439	0.087	-5.83	0.09775	-4.95	0.1085	-6.93
0.06575	-0.989	0.0765	0.439	0.08725	-6.05	0.098	-4.73	0.10875	-7.04
0.066	-0.33	0.07675	0.549	0.0875	-6.38	0.09825	-4.84	0.109	-6.82
0.06625	-0.22	0.077	0.329	0.08775	-5.94	0.0985	-4.73	0.10925	-7.26
0.0665	0	0.07725	0.329	0.088	-5.39	0.09875	-4.4	0.1095	-7.26
0.06675	0.22	0.0775	0.329	0.08825	-5.39	0.099	-4.29	0.10975	-6.71
0.067	0.439	0.07775	0.329	0.0885	-5.28	0.09925	-4.29	0.11	-6.6
0.06725	0.659	0.078	0.329	0.08875	-5.28	0.0995	-4.29	0.11025	-6.16
0.0675	1.21	0.07825	0.22	0.089	-5.39	0.09975	-4.84	0.1105	-5.94
0.06775	1.65	0.0785	-0.439	0.08925	-5.5	0.1	-4.84	0.11075	-6.6
0.068	1.76	0.07875	-0.22	0.0895	-5.61	0.10025	-4.84	0.111	-6.71
0.06825	1.76	0.079	0.22	0.08975	-5.83	0.1005	-5.39	0.11125	-6.6
0.0685	1.87	0.07925	0.329	0.09	-5.83	0.10075	-5.72	0.1115	-6.82
0.06875	1.76	0.0795	0.329	0.09025	-5.61	0.101	-5.83	0.11175	-7.15
0.069	1.54	0.07975	0	0.0905	-5.5	0.10125	-5.94	0.112	-7.6
0.06925	1.43	0.08	-0.439	0.09075	-5.39	0.1015	-6.6	0.11225	-7.93
0.0695	1.21	0.08025	-0.769	0.091	-5.72	0.10175	-6.71	0.1125	-8.15
0.06975	0.879	0.0805	-1.21	0.09125	-5.94	0.102	-6.93	0.11275	-8.15
0.07	0.439	0.08075	-1.76	0.0915	-5.94	0.10225	-6.93	0.113	-8.92
0.07025	0.11	0.081	-3.08	0.09175	-6.05	0.1025	-7.15	0.11325	-9.47
0.0705	-0.33	0.08125	-3.41	0.092	-5.94	0.10275	-7.37	0.1135	-9.47
0.07075	-0.22	0.0815	-3.52	0.09225	-6.05	0.103	-7.49	0.11375	-8.59
0.071	0	0.08175	-3.52	0.0925	-6.38	0.10325	-7.49	0.114	-7.49
0.07125	-0.22	0.082	-3.96	0.09275	-6.27	0.1035	-7.6	0.11425	-7.15
0.0715	-0.989	0.08225	-4.29	0.093	-5.94	0.10375	-7.49	0.1145	-7.71
0.07175	-1.32	0.0825	-4.29	0.09325	-5.83	0.104	-7.6	0.11475	-8.26
0.072	-1.54	0.08275	-4.4	0.0935	-5.5	0.10425	-7.49	0.115	-8.92
0.07225	-1.87	0.083	-4.95	0.09375	-5.5	0.1045	-7.26	0.11525	-9.14
0.0725	-2.2	0.08325	-5.39	0.094	-5.5	0.10475	-7.15	0.1155	-8.59
0.07275	-2.42	0.0835	-5.61	0.09425	-5.28	0.105	-6.6	0.11575	-7.93
0.073	-2.75	0.08375	-5.94	0.0945	-5.17	0.10525	-6.16	0.116	-7.6
0.07325	-2.42	0.084	-6.71	0.09475	-4.95	0.1055	-5.72	0.11625	-8.04
0.0735	-2.53	0.08425	-6.93	0.095	-4.95	0.10575	-5.17	0.1165	-8.81
0.07375	-2.31	0.0845	-7.04	0.09525	-4.73	0.106	-5.83	0.11675	-9.8
0.074	-1.98	0.08475	-6.82	0.0955	-4.84	0.10625	-6.82	0.117	-9.47
0.07425	-1.87	0.085	-6.71	0.09575	-4.62	0.1065	-7.37	0.11725	-8.48
0.0745	-1.76	0.08525	-6.71	0.096	-4.29	0.10675	-7.93	0.1175	-8.7

Gauge14_3	Gauge14_3	Gauge14_3	Gauge14_3	Gauge14_4	Gauge14_4	Gauge14_4	Gauge14_4	Gauge14_4	Gauge14_4
Time	Stress	Time	Stress	Time	Stress	Time	Stress	Time	Stress
msec	MPa	msec	MPa	msec	MPa	msec	MPa	msec	MPa
0.11775	-8.81	0.1285	-7.26	0.07175	0.169	0.0825	0.056	0.09325	-0.339
0.118	-8.92	0.12875	-7.15	0.072	0.282	0.08275	0.339	0.0935	-0.113
0.11825	-8.48	0.129	-6.93	0.07225	0.846	0.083	0.564	0.09375	-0.226
0.1185	-8.48	0.12925	-7.04	0.0725	0.79	0.08325	0.395	0.094	-0.169
0.11875	-8.26	0.1295	-8.37	0.07275	0.508	0.0835	0.282	0.09425	-0.169
0.119	-7.93	0.12975	-8.92	0.073	0.339	0.08375	0	0.0945	-0.113
0.11925	-7.82	0.13	-8.48	0.07325	0.564	0.084	0.056	0.09475	0
0.1195	-7.93	0.13025	-9.14	0.0735	0.677	0.08425	0.056	0.095	0.508
0.11975	-7.71	0.1305	-10.02	0.07375	0.564	0.0845	-0.113	0.09525	0.508
0.12	-7.37	0.13075	-10.8	0.074	0.79	0.08475	-0.113	0.0955	0.226
0.12025	-7.15	0.131	-11.02	0.07425	0.846	0.085	-0.056	0.09575	0.056
0.1205	-6.82	0.13125	-11.13	0.0745	0.621	0.08525	0.056	0.096	0.339
0.12075	-6.71	0.1315	-11.02	0.07475	0.508	0.0855	0.056	0.09625	0.226
0.121	-6.6	0.13175	-10.91	0.075	0	0.08575	0.169	0.0965	0.113
0.12125	-6.38	0.132	-10.58	0.07525	0.056	0.086	0.621	0.09675	0
0.1215	-6.82	0.13225	-9.58	0.0755	0.113	0.08625	0.79	0.097	0.056
0.12175	-5.94	0.1325	-11.02	0.07575	0.056	0.0865	1.3	0.09725	0.113
0.122	-5.28	0.13275	-11.68	0.076	0.339	0.08675	0.959	0.0975	0.282
0.12225	-5.83	0.133	-11.24	0.07625	0.451	0.087	0.621	0.09775	0
0.1225	-5.94	0.13325	-13.56	0.0765	0.339	0.08725	0.508	0.098	-0.226
0.12275	-5.94	0.1335	-13.56	0.07675	0.395	0.0875	0.621	0.09825	-0.169
0.123	-5.28	0.13375	-10.91	0.077	0.508	0.08775	0.621	0.0985	-0.056
0.12325	-5.72	0.134	-10.13	0.07725	0.564	0.088	0.169	0.09875	0.169
0.1235	-5.28			0.0775	0.169	0.08825	0	0.099	0.113
0.12375	-5.61			0.07775	0.113	0.0885	0.169	0.09925	0.113
0.124	-9.91			0.078	0.169	0.08875	0.508	0.0995	0.339
0.12425	-5.94			0.07825	-0.056	0.089	0.564	0.09975	0.451
0.1245	-4.95			0.0785	-0.113	0.08925	0.79	0.1	0.451
0.12475	-5.61			0.07875	-0.113	0.0895	0.339	0.10025	0.79
0.125	-6.05			0.079	-0.056	0.08975	0.282	0.1005	1.07
0.12525	-6.27			0.07925	0	0.09	0.395	0.10075	1.02
0.1255	-6.6			0.0795	-0.056	0.09025	0.339	0.101	1.3
0.12575	-6.6			0.07975	-0.056	0.0905	0.056	0.10125	1.97
0.126	-6.82			0.08	0.226	0.09075	-0.169	0.1015	2.14
0.12625	-6.6			0.08025	0.621	0.091	-0.113	0.10175	2.09
0.1265	-6.6			0.0805	0.395	0.09125	-0.169	0.102	2.26
0.12675	-6.49			0.08075	0.056	0.0915	-0.056	0.10225	2.31
0.127	-6.71			0.081	0.226	0.09175	-0.226	0.1025	2.48
0.12725	-6.82			0.08125	0.733	0.092	-0.282	0.10275	2.76
0.1275	-6.27			0.0815	0.395	0.09225	-0.226	0.103	3.27
0.12775	-6.6			0.08175	-0.056	0.0925	-0.451	0.10325	3.83
0.128	-7.04			0.082	-0.113	0.09275	-0.339	0.1035	4.4
0.12825	-7.49			0.08225	-0.113	0.093	-0.395	0.10375	5.07

Gauge1_4_4	Gauge1_4_4	Gauge1_4_4	Gauge1_4_4	Gauge1_4_4	Gauge1_4_4	Gauge1_4_4	Gauge1_4_4	Gauge1_4_5	Gauge1_4_5
Time	Stress	Time	Stress	Time	Stress	Time	Stress	Time	Stress
msec	MPa	msec	MPa	msec	MPa	msec	MPa	msec	MPa
0.104	5.07	0.11475	5.02	0.1255	1.8	0.13625	-0.169	0.04925	0
0.10425	5.07	0.115	4.85	0.12575	1.64	0.1365	-2.99	0.04975	0
0.1045	5.07	0.11525	4.9	0.126	1.41	0.13675	-1.81	0.05025	0
0.10475	5.07	0.1155	5.02	0.12625	0.846	0.137	-0.113	0.05075	0.057
0.105	5.07	0.11575	5.02	0.1265	0.564	0.13725	0.169	0.05125	0.057
0.10525	5.07	0.116	5.02	0.12675	0.959	0.1375	0.113	0.05175	0
0.1055	5.07	0.11625	4.9	0.127	0.564	0.13775	0.056	0.05225	0.057
0.10575	5.07	0.1165	4.9	0.12725	0.508	0.138	0.056	0.05275	0.283
0.106	5.07	0.11675	4.9	0.1275	0.282	0.13825	0	0.05325	0.34
0.10625	5.07	0.117	4.79	0.12775	0.621	0.1385	-0.169	0.05375	0.227
0.1065	5.07	0.11725	4.68	0.128	0.903	0.13875	0.226	0.05425	0.227
0.10675	5.07	0.1175	4.73	0.12825	0.677	0.139	1.07	0.05475	0.283
0.107	5.07	0.11775	5.02	0.1285	-1.13	0.13925	0.339	0.05525	0.17
0.10725	4.68	0.118	5.02	0.12875	0.395	0.1395	0.339	0.05575	0.34
0.1075	4.06	0.11825	5.02	0.129	1.13	0.13975	0.113	0.05625	0.227
0.10775	4.56	0.1185	5.02	0.12925	1.02	0.14	-0.677	0.05675	0.057
0.108	4.28	0.11875	4.85	0.1295	0.79	0.14025	0	0.05725	-0.17
0.10825	3.72	0.119	5.02	0.12975	0.903	0.1405	-3.33	0.05775	0
0.1085	3.55	0.11925	5.02	0.13	1.3	0.14075	-5.88	0.05825	-0.113
0.10875	4.17	0.1195	4.85	0.13025	1.58	0.141	-4.01	0.05875	-0.51
0.109	4.73	0.11975	4.51	0.1305	0.903	0.14125	-2.48	0.05925	-0.17
0.10925	5.02	0.12	4.23	0.13075	0.564	0.1415	-1.98	0.05975	-0.227
0.1095	5.07	0.12025	3.61	0.131	0.564			0.06025	-0.227
0.10975	5.07	0.1205	3.38	0.13125	0.621			0.06075	-0.283
0.11	4.96	0.12075	3.04	0.1315	0.733			0.06125	-0.057
0.11025	4.51	0.121	2.88	0.13175	0.339			0.06175	-0.17
0.1105	4.11	0.12125	2.71	0.132	0.395			0.06225	-0.227
0.11075	3.95	0.1215	2.14	0.13225	-0.113			0.06275	-0.397
0.111	3.89	0.12175	1.97	0.1325	-0.226			0.06325	-0.227
0.11125	3.95	0.122	2.42	0.13275	-0.056			0.06375	-0.113
0.1115	4.23	0.12225	2.76	0.133	-0.113			0.06425	-0.113
0.11175	4.62	0.1225	2.59	0.13325	-0.113			0.06475	0.057
0.112	4.9	0.12275	3.04	0.1335	0			0.06525	0.057
0.11225	5.02	0.123	3.33	0.13375	0			0.06575	-0.68
0.1125	5.07	0.12325	3.44	0.134	0.113			0.06625	-0.227
0.11275	5.02	0.1235	3.27	0.13425	-0.113			0.06675	-0.34
0.113	5.02	0.12375	3.04	0.1345	0			0.06725	-0.34
0.11325	5.02	0.124	2.48	0.13475	0.226			0.06775	-0.397
0.1135	5.02	0.12425	2.59	0.135	0.169			0.06825	-0.283
0.11375	5.02	0.1245	2.37	0.13525	0.282			0.06875	-0.057
0.114	5.02	0.12475	2.31	0.1355	-0.113			0.06925	-0.34
0.11425	5.02	0.125	2.31	0.13575	-0.395			0.06975	-0.51
0.1145	5.02	0.12525	2.03	0.136	-0.226			0.07025	-0.17

Gauge1_4_5	Gauge1_4_5	Gauge1_4_5	Gauge1_4_5	Gauge1_4_6	Gauge1_4_6	Gauge1_4_6	Gauge1_4_6	Gauge1_4_6	Gauge1_4_6
Time	Stress	Time	Stress	Time	Stress	Time	Stress	Time	Stress
msec	MPa	msec	MPa	msec	MPa	msec	MPa	msec	MPa
0.07075	-0.113	0.09225	-0.227	0.05675	0.022	0.0675	0.011	0.07825	0
0.07125	-0.34	0.09275	-0.057	0.057	-0.066	0.06775	-0.044	0.0785	-0.088
0.07175	-0.737	0.09325	2.77	0.05725	-0.022	0.068	0.055	0.07875	-0.088
0.07225	-0.283	0.09375	0.227	0.0575	-0.066	0.06825	-0.066	0.079	-0.175
0.07275	-0.057	0.09425	0.397	0.05775	-0.022	0.0685	0	0.07925	-0.219
0.07325	-0.227	0.09475	-0.227	0.058	-0.044	0.06875	0.022	0.0795	-0.142
0.07375	-0.34	0.09525	-0.283	0.05825	-0.022	0.069	-0.022	0.07975	-0.219
0.07425	-0.34	0.09575	-5.56	0.0585	-0.022	0.06925	0	0.08	-0.295
0.07475	-1.08	0.09625	-0.737	0.05875	-0.022	0.0695	-0.022	0.08025	-0.197
0.07525	-0.793	0.09675	0.17	0.059	0.022	0.06975	0.022	0.0805	-0.088
0.07575	-0.51	0.09725	0.227	0.05925	0	0.07	0	0.08075	-0.022
0.07625	0.34	0.09775	-0.283	0.0595	0.022	0.07025	0	0.081	-0.088
0.07675	0.453	0.09825	-0.057	0.05975	0	0.0705	0	0.08125	-0.897
0.07725	-0.793	0.09875	0.17	0.06	0	0.07075	0.022	0.0815	-3.4
0.07775	-0.623	0.09925	0.113	0.06025	0.022	0.071	0.022	0.08175	-2.19
0.07825	-1.25	0.09975	0.227	0.0605	0.022	0.07125	0	0.082	-1.07
0.07875	-0.68	0.10025	0.227	0.06075	0	0.0715	0.022	0.08225	-1.03
0.07925	-0.907	0.10075	0.397	0.061	0.022	0.07175	0.044	0.0825	-0.963
0.07975	-1.53	0.10125	-1.36	0.06125	0.044	0.072	0.044	0.08275	-0.897
0.08025	3.11	0.10175	0.227	0.0615	0.022	0.07225	0.044	0.083	-0.908
0.08075	-0.227			0.06175	0.044	0.0725	0.022	0.08325	-0.744
0.08125	1.98			0.062	0.055	0.07275	0.044	0.0835	0.274
0.08175	0.34			0.06225	0.044	0.073	0.055	0.08375	0.153
0.08225	1.13			0.0625	0.044	0.07325	0.044	0.084	-0.383
0.08275	1.76			0.06275	0	0.0735	0.077	0.08425	-1.38
0.08325	0.17			0.063	0.011	0.07375	0.088	0.0845	-1.01
0.08375	0.68			0.06325	0.022	0.074	0.109	0.08475	-0.547
0.08425	0			0.0635	0.022	0.07425	0.088	0.085	-0.854
0.08475	0.113			0.06375	0.022	0.0745	0.088	0.08525	-1.88
0.08525	0.397			0.064	0.022	0.07475	0.109	0.0855	-1.87
0.08575	0.736			0.06425	0.022	0.075	0.131	0.08575	-1.75
0.08625	0.566			0.0645	0.066	0.07525	0.175	0.086	-1.14
0.08675	0			0.06475	0.044	0.0755	0.219	0.08625	-0.7
0.08725	-0.057			0.065	0.033	0.07575	0.219	0.0865	-0.427
0.08775	0.227			0.06525	0.022	0.076	0.197	0.08675	-0.482
0.08825	-0.113			0.0655	0.022	0.07625	0.197	0.087	-1.31
0.08875	-0.113			0.06575	0	0.0765	0.197	0.08725	-1.34
0.08925	-0.057			0.066	-0.175	0.07675	0.197	0.0875	-0.941
0.08975	-7.04			0.06625	0.066	0.077	0.186	0.08775	-0.744
0.09025	0.85			0.0665	-0.088	0.07725	0.131	0.088	-0.766
0.09075	0.227			0.06675	0.066	0.0775	-0.088	0.08825	-0.919
0.09125	0.227			0.067	-0.066	0.07775	-0.022	0.0885	-1.03
0.09175	-0.057			0.06725	-0.022	0.078	0.022	0.08875	-0.963

Gauge14_6 Time msec	Gauge14_6 Stress MPa	Gauge14_6 Time msec	Gauge14_6 Stress MPa	Gauge14_6 Time msec	Gauge14_6 Stress MPa	Gauge14_6 Time msec	Gauge14_6 Stress MPa	Gauge14_6 Time msec	Gauge14_6 Stress MPa
0.089	-0.722	0.09975	0.022	0.1105	0.438	0.12125	-0.35	0.132	0.197
0.08925	-1.4	0.1	-0.175	0.11075	0.416	0.1215	-0.361	0.13225	0.066
0.0895	-1.73	0.10025	-0.219	0.111	0.317	0.12175	-0.372	0.1325	0.131
0.08975	-1.88	0.1005	-0.044	0.11125	0.328	0.122	-0.471	0.13275	0.153
0.09	-1.71	0.10075	-0.022	0.1115	0.252	0.12225	-0.438	0.133	-0.12
0.09025	-1.44	0.101	0	0.11175	0.241	0.1225	0.744	0.13325	0.175
0.0905	-0.744	0.10125	0.022	0.112	-0.131	0.12275	0.788	0.1335	0.263
0.09075	-0.285	0.1015	0.022	0.11225	-0.832	0.123	0.306	0.13375	0.131
0.091	-0.066	0.10175	0.066	0.1125	-0.011	0.12325	0.153	0.134	0.077
0.09125	-0.022	0.102	0.131	0.11275	0.284	0.1235	0.219	0.13425	0.066
0.0915	-0.175	0.10225	0.153	0.113	0.284	0.12375	0.219	0.1345	-0.044
0.09175	-0.109	0.1025	0.109	0.11325	0.197	0.124	0.186	0.13475	-0.131
0.092	-0.022	0.10275	-0.219	0.1135	0.317	0.12425	0.219	0.135	-0.12
0.09225	0.131	0.103	0.23	0.11375	0.284	0.1245	0.186	0.13525	-0.285
0.0925	-0.022	0.10325	0.153	0.114	0.328	0.12475	0.066	0.1355	-0.263
0.09275	-0.066	0.1035	0.23	0.11425	0.284	0.125	-0.055	0.13575	0.284
0.093	-0.12	0.10375	0.241	0.1145	0.284	0.12525	-0.219	0.136	0.328
0.09325	-0.197	0.104	0.263	0.11475	0.263	0.1255	-0.613	0.13625	0.284
0.0935	-0.23	0.10425	0.241	0.115	0.427	0.12575	-1.51	0.1365	0.241
0.09375	-1.27	0.1045	0.263	0.11525	0.438	0.126	-1.99	0.13675	0.263
0.094	-1.89	0.10475	0.219	0.1155	0.328	0.12625	-1.82	0.137	0.241
0.09425	-1.4	0.105	0.23	0.11575	0.328	0.1265	-1.86	0.13725	-0.044
0.0945	-0.755	0.10525	0.219	0.116	0.328	0.12675	-1.95	0.1375	-0.175
0.09475	-0.569	0.1055	0.197	0.11625	0.306	0.127	0.678	0.13775	-0.175
0.095	-0.503	0.10575	0.241	0.1165	0.306	0.12725	1.42	0.138	-0.306
0.09525	-0.525	0.106	0.274	0.11675	0.328	0.1275	0.656	0.13825	-0.372
0.0955	-0.558	0.10625	0.263	0.117	0.284	0.12775	-0.109	0.1385	-0.46
0.09575	-0.679	0.1065	0.361	0.11725	0.263	0.128	-0.109	0.13875	-0.679
0.096	-0.657	0.10675	0.481	0.1175	0.328	0.12825	0.044	0.139	-0.744
0.09625	-0.657	0.107	0.481	0.11775	0.394	0.1285	0.066	0.13925	-0.525
0.0965	-1.07	0.10725	0.481	0.118	0.263	0.12875	-0.066	0.1395	-0.066
0.09675	-1.86	0.1075	0.481	0.11825	0.153	0.129	-0.175	0.13975	-0.153
0.097	-1.72	0.10775	0.438	0.1185	0.088	0.12925	-0.416	0.14	-0.219
0.09725	-1.01	0.108	0.438	0.11875	0.088	0.1295	-0.744	0.14025	-0.109
0.0975	-1.28	0.10825	0.503	0.119	0.022	0.12975	-1.05	0.1405	-0.066
0.09775	-0.766	0.1085	0.569	0.11925	-0.153	0.13	-1.09	0.14075	-0.066
0.098	0	0.10875	0.591	0.1195	-0.197	0.13025	-1.07	0.141	0.613
0.09825	0.219	0.109	0.525	0.11975	-0.175	0.1305	-0.722	0.14125	1.4
0.0985	0.219	0.10925	0.438	0.12	-0.175	0.13075	-0.35	0.1415	1.17
0.09875	0.175	0.1095	0.438	0.12025	-0.263	0.131	-0.241	0.14175	0.394
0.099	0.153	0.10975	0.46	0.1205	-0.372	0.13125	0.985	0.142	0.328
0.09925	0.109	0.11	0.46	0.12075	-0.438	0.1315	1.42	0.14225	0.35
0.0995	0.109	0.11025	0.438	0.121	-0.416	0.13175	1.42	0.1425	0.383

Gauge14_6 Time msec	Gauge14_6 Stress MPa	Gauge14_6 Time msec	Gauge14_6 Stress MPa
0.14275	0.394	0.1535	-0.055
0.143	0.416	0.15375	-0.022
0.14325	0.416	0.154	-0.285
0.1435	0.405	0.15425	-0.306
0.14375	0.394	0.1545	-0.098
0.144	0.394	0.15475	-0.285
0.14425	0.284		
0.1445	0.153		
0.14475	0.131		
0.145	0.077		
0.14525	-0.044		
0.1455	-0.23		
0.14575	-0.328		
0.146	-0.482		
0.14625	-0.547		
0.1465	-0.438		
0.14675	-0.306		
0.147	-0.328		
0.14725	-0.416		
0.1475	-0.46		
0.14775	-0.482		
0.148	-0.525		
0.14825	-0.525		
0.1485	-0.46		
0.14875	-0.394		
0.149	-0.372		
0.14925	-0.372		
0.1495	-0.263		
0.14975	-0.153		
0.15	-0.131		
0.15025	-0.066		
0.1505	0		
0.15075	0.109		
0.151	0.175		
0.15125	0.109		
0.1515	0.077		
0.15175	0.088		
0.152	0.077		
0.15225	0.088		
0.1525	0.088		
0.15275	0.088		
0.153	0.011		
0.15325	-0.022		

Gauge15_1 Time msec	Gauge15_1 Stress MPa	Gauge15_1 Time msec	Gauge15_1 Stress MPa	Gauge15_1 Time msec	Gauge15_1 Stress MPa	Gauge15_1 Time msec	Gauge15_1 Stress MPa	Gauge15_1 Time msec	Gauge15_1 Stress MPa
-0.01425	0	-0.0035	0	0.00725	-95.04	0.018	0	0.02875	90
-0.014	17.22	-0.00325	0	0.0075	-17.39	0.01825	-17.39	0.029	57.38
-0.01375	17.22	-0.003	17.22	0.00775	605.03	0.0185	-17.39	0.02925	57.38
-0.0135	0	-0.00275	0	0.008	90	0.01875	-17.39	0.0295	90
-0.01325	0	-0.0025	0	0.00825	-34.95	0.019	0	0.02975	90
-0.013	17.22	-0.00225	17.22	0.0085	17.22	0.01925	17.22	0.03	57.38
-0.01275	0	-0.002	0	0.00875	17.22	0.0195	17.22	0.03025	57.38
-0.0125	0	-0.00175	0	0.009	0	0.01975	0	0.0305	57.38
-0.01225	0	-0.0015	0	0.00925	0	0.02	17.22	0.03075	34.26
-0.012	17.22	-0.00125	17.22	0.0095	34.26	0.02025	0	0.031	17.22
-0.01175	0	-0.001	17.22	0.00975	90	0.0205	0	0.03125	17.22
-0.0115	0	-0.00075	0	0.01	145.31	0.02075	17.22	0.0315	34.26
-0.01125	0	-0.0005	17.22	0.01025	17.22	0.021	17.22	0.03175	34.26
-0.011	17.22	-0.00025	0	0.0105	-34.95	0.02125	34.26	0.032	34.26
-0.01075	0	0	17.22	0.01075	169.66	0.0215	34.26	0.03225	34.26
-0.0105	0	0.00025	34.26	0.011	17.22	0.02175	34.26	0.0325	34.26
-0.01025	0	0.0005	145.31	0.01125	-17.39	0.022	17.22	0.03275	34.26
-0.01	0	0.00075	237.12	0.0115	57.38	0.02225	145.31	0.033	34.26
-0.00975	0	0.001	329.78	0.01175	17.22	0.0225	119.02	0.03325	34.26
-0.0095	0	0.00125	718.99	0.012	0	0.02275	34.26	0.0335	34.26
-0.00925	0	0.0015	1014.12	0.01225	17.22	0.023	57.38	0.03375	17.22
-0.009	0	0.00175	1103.18	0.0125	17.22	0.02325	57.38	0.034	34.26
-0.00875	17.22	0.002	1148.15	0.01275	-17.39	0.0235	57.38	0.03425	17.22
-0.0085	0	0.00225	1148.15	0.013	0	0.02375	34.26	0.0345	34.26
-0.00825	0	0.0025	1103.18	0.01325	-17.39	0.024	57.38	0.03475	34.26
-0.008	17.22	0.00275	970.16	0.0135	-17.39	0.02425	34.26	0.035	17.22
-0.00775	0	0.003	883.73	0.01375	0	0.0245	90	0.03525	0
-0.0075	-17.39	0.00325	758.96	0.014	17.22	0.02475	57.38	0.0355	17.22
-0.00725	17.22	0.0035	534.76	0.01425	17.22	0.025	34.26	0.03575	0
-0.007	0	0.00375	282.02	0.0145	0	0.02525	34.26	0.036	17.22
-0.00675	0	0.004	57.38	0.01475	17.22	0.0255	34.26	0.03625	17.22
-0.0065	0	0.00425	34.26	0.015	0	0.02575	17.22	0.0365	17.22
-0.00625	17.22	0.0045	0	0.01525	-34.95	0.026	57.38	0.03675	17.22
-0.006	0	0.00475	17.22	0.0155	0	0.02625	57.38	0.037	17.22
-0.00575	0	0.005	17.22	0.01575	17.22	0.0265	90	0.03725	34.26
-0.0055	17.22	0.00525	-17.39	0.016	0	0.02675	119.02	0.0375	0
-0.00525	0	0.0055	-17.39	0.01625	17.22	0.027	119.02	0.03775	0
-0.005	17.22	0.00575	-181.9	0.0165	17.22	0.02725	119.02	0.038	17.22
-0.00475	0	0.006	-234.69	0.01675	17.22	0.0275	90	0.03825	0
-0.0045	17.22	0.00625	-208.27	0.017	0	0.02775	90	0.0385	17.22
-0.00425	17.22	0.0065	-95.04	0.01725	-17.39	0.028	57.38	0.03875	17.22
-0.004	0	0.00675	-181.9	0.0175	0	0.02825	90	0.039	0
0.00375	0	0.007	-126.14	0.01775	0	0.0285	90	0.03925	0

Gauge15_1 Time msec	Gauge15_1 Stress MPa	Gauge15_2 Time msec	Gauge15_2 Stress MPa	Gauge15_2 Time msec	Gauge15_2 Stress MPa	Gauge15_2 Time msec	Gauge15_2 Stress MPa	Gauge15_2 Time msec	Gauge15_2 Stress MPa
0.0395	17.22	0.024	-0.106	0.0455	0	0.067	7.64	0.0885	10.29
0.03975	17.22	0.0245	0	0.046	-0.106	0.0675	6.9	0.089	14.3
0.04	17.22	0.025	0.106	0.0465	0.106	0.068	6.37	0.0895	9.02
0.04025	0	0.0255	0.213	0.047	-0.106	0.0685	6.27	0.09	5.31
0.0405	0	0.026	0.106	0.0475	0	0.069	5.63	0.0905	2.34
0.04075	0	0.0265	0.106	0.048	0	0.0695	5.63	0.091	4.46
0.041	17.22	0.027	0.106	0.0485	0	0.07	5.63	0.0915	5.84
0.04125	0	0.0275	0.106	0.049	0.106	0.0705	5.52	0.092	2.76
0.0415	17.22	0.028	0.106	0.0495	0.106	0.071	5.1	0.0925	5.31
0.04175	0	0.0285	0.106	0.05	-0.106	0.0715	5.1	0.093	7.75
0.042	0	0.029	0.106	0.0505	-0.106	0.072	5.21	0.0935	9.02
0.04225	-17.39	0.0295	0	0.051	0	0.0725	4.89	0.094	7.22
0.0425	0	0.03	0	0.0515	-0.106	0.073	4.89	0.0945	7.43
0.04275	0	0.0305	-0.106	0.052	-0.319	0.0735	4.57	0.095	6.27
0.043	0	0.031	0	0.0525	-0.213	0.074	4.99	0.0955	9.87
0.04325	-17.39	0.0315	0.213	0.053	0.106	0.0745	5.21	0.096	8.07
0.0435	-967.84	0.032	0.106	0.0535	0.319	0.075	5.1	0.0965	4.78
		0.0325	0	0.054	0.957	0.0755	4.78	0.097	6.8
		0.033	0.106	0.0545	7.85	0.076	4.89	0.0975	8.17
		0.0335	0.319	0.055	15.46	0.0765	4.89	0.098	7.32
		0.034	0.213	0.0555	15.15	0.077	4.99	0.0985	8.07
		0.0345	0	0.056	15.36	0.0775	4.99	0.099	6.16
		0.035	0.106	0.0565	11.24	0.078	5.1	0.0995	6.8
		0.0355	-0.106	0.057	11.56	0.0785	5.52	0.1	7.32
		0.036	0	0.0575	10.08	0.079	5.31	0.1005	7.11
		0.0365	-0.106	0.058	10.61	0.0795	5.21	0.101	5.84
		0.037	-0.213	0.0585	11.03	0.08	4.89	0.1015	7.01
		0.0375	-0.106	0.059	11.56	0.0805	4.89	0.102	6.05
		0.038	-0.106	0.0595	11.56	0.081	5.1	0.1025	4.36
		0.0385	0	0.06	10.71	0.0815	5.1	0.103	7.64
		0.039	-0.106	0.0605	8.7	0.082	4.78	0.1035	6.16
		0.0395	-0.106	0.061	7.01	0.0825	4.89	0.104	6.58
		0.04	-0.213	0.0615	6.16	0.083	4.78	0.1045	8.49
		0.0405	0	0.062	5.95	0.0835	4.99	0.105	6.48
		0.041	0.106	0.0625	6.05	0.084	4.99	0.1055	8.17
		0.0415	0	0.063	6.27	0.0845	3.08	0.106	7.43
		0.042	-0.106	0.0635	6.48	0.085	5.42	0.1065	6.9
		0.0425	0.213	0.064	7.22	0.0855	6.37	0.107	6.58
		0.043	0.106	0.0645	7.64	0.086	6.37	0.1075	6.05
		0.0435	-0.106	0.065	7.85	0.0865	7.96	0.108	5.95
		0.044	-3.41	0.0655	8.6	0.087	7.64	0.1085	6.58
		0.0445	0.106	0.066	8.07	0.0875	9.23	0.109	7.43
		0.045	0	0.0665	8.17	0.088	10.61	0.1095	7.43

Gauge15_2 Time msec	Gauge15_2 Stress MPa	Gauge15_2 Time msec	Gauge15_2 Stress MPa	Gauge15_2 Time msec	Gauge15_2 Stress MPa	Gauge15_3 Time msec	Gauge15_3 Stress MPa	Gauge15_3 Time msec	Gauge15_3 Stress MPa
0.11	9.65	0.1315	0.638	0.153	1.81	0.0315	0.219	0.04225	0.219
0.1105	6.16	0.132	2.23	0.1535	0.957	0.03175	0.11	0.0425	0.219
0.111	7.22	0.1325	2.02	0.154	0.638	0.032	0.11	0.04275	0.11
0.1115	4.14	0.133	2.02	0.1545	0.213	0.03225	0.11	0.043	0.11
0.112	5.31	0.1335	1.6	0.155	-2.87	0.0325	0.219	0.04325	0.11
0.1125	5.95	0.134	4.78	0.1555	2.23	0.03275	0.219	0.0435	0.11
0.113	5.63	0.1345	5.63	0.156	0	0.033	0.219	0.04375	0
0.1135	4.78	0.135	6.9	0.1565	2.02	0.03325	0.11	0.044	0
0.114	6.69	0.1355	6.48	0.157	-0.106	0.0335	0.11	0.04425	0
0.1145	6.16	0.136	6.69	0.1575	0	0.03375	0.11	0.0445	0.11
0.115	9.55	0.1365	5.95	0.158	1.6	0.034	0.11	0.04475	0.11
0.1155	8.07	0.137	4.99	0.1585	4.99	0.03425	0.11	0.045	0.11
0.116	5.31	0.1375	5.1	0.159	4.46	0.0345	0.11	0.04525	0.11
0.1165	6.58	0.138	-4.36	0.1595	1.81	0.03475	0.219	0.0455	-0.11
0.117	8.38	0.1385	2.98	0.16	3.08	0.035	0.219	0.04575	-0.11
0.1175	5.84	0.139	3.4	0.1605	15.25	0.03525	0.219	0.046	-0.11
0.118	2.76	0.1395	2.87	0.161	9.44	0.0355	0.329	0.04625	-0.219
0.1185	6.16	0.14	1.6	0.1615	6.05	0.03575	0.329	0.0465	0
0.119	6.58	0.1405	1.81	0.162	7.11	0.036	0.329	0.04675	0
0.1195	7.22	0.141	0.532	0.1625	-9.39	0.03625	0.219	0.047	0
0.12	4.78	0.1415	2.76	0.163	4.25	0.0365	0.219	0.04725	0
0.1205	5.21	0.142	-0.319	0.1635	6.58	0.03675	0.219	0.0475	0
0.121	4.78	0.1425	0.426	0.164	5.42	0.037	0.11	0.04775	0.11
0.1215	3.29	0.143	2.66	0.1645	3.93	0.03725	0.11	0.048	0.11
0.122	4.04	0.1435	5.42	0.165	5.95	0.0375	0.11	0.04825	0
0.1225	2.76	0.144	1.81	0.1655	15.25	0.03775	0.11	0.0485	0
0.123	0.745	0.1445	2.76	0.166	15.25	0.038	0.11	0.04875	0.11
0.1235	-0.851	0.145	2.45	0.1665	4.99	0.03825	0.219	0.049	0.11
0.124	-2.77	0.1455	1.28	0.167	4.67	0.0385	0.219	0.04925	-0.11
0.1245	-1.7	0.146	10.29	0.1675	9.34	0.03875	0.11	0.0495	-0.11
0.125	1.81	0.1465	2.02	0.168	7.96	0.039	0.11	0.04975	0.11
0.1255	-0.851	0.147	1.7	0.1685	7.75	0.03925	0.11	0.05	0.11
0.126	1.81	0.1475	-0.106	0.169	8.7	0.0395	0	0.05025	0.11
0.1265	-0.532	0.148	1.43	0.1695	8.49	0.03975	0.11	0.0505	0.329
0.127	1.17	0.1485	4.46	0.17	15.15	0.04	0.11	0.05075	0.329
0.1275	0	0.149	2.34	0.1705	9.97	0.04025	0.11	0.051	0.219
0.128	2.76	0.1495	1.6	0.171	6.16	0.0405	0.11	0.05125	0.219
0.1285	2.34	0.15	1.38	0.1715	8.07	0.04075	0.11	0.0515	0.219
0.129	2.45	0.1505	-0.213	0.172	11.45	0.041	0.11	0.05175	0.219
0.1295	11.98	0.151	-1.28	0.1725	12.93	0.04125	0.11	0.052	0.219
0.13	2.02	0.1515	-0.745	0.173	6.69	0.0415	0.219	0.05225	0.219
0.1305	2.66	0.152	-1.17			0.04175	0.11	0.0525	0.219
0.131	2.66	0.1525	-0.106			0.042	0.11	0.05275	0.219

Gauge15_3 Time msec	Gauge15_3 Stress MPa	Gauge15_3 Time msec	Gauge15_3 Stress MPa	Gauge15_3 Time msec	Gauge15_3 Stress MPa	Gauge15_3 Time msec	Gauge15_3 Stress MPa	Gauge15_3 Time msec	Gauge15_3 Stress MPa
0.053	0.219	0.06375	1.75	0.0745	2.96	0.08525	5.04	0.096	1.53
0.05325	0.219	0.064	1.64	0.07475	3.5	0.0855	4.93	0.09625	1.53
0.0535	0.11	0.06425	1.53	0.075	3.83	0.08575	3.72	0.0965	1.53
0.05375	0.11	0.0645	1.86	0.07525	3.94	0.086	3.29	0.09675	1.75
0.054	0	0.06475	2.3	0.0755	3.83	0.08625	3.72	0.097	1.75
0.05425	-0.11	0.065	2.74	0.07575	3.72	0.0865	4.05	0.09725	1.64
0.0545	0.219	0.06525	3.4	0.076	3.61	0.08675	3.72	0.0975	1.64
0.05475	0.219	0.0655	3.94	0.07625	3.5	0.087	3.72	0.09775	1.64
0.055	0.329	0.06575	4.38	0.0765	3.29	0.08725	3.29	0.098	1.64
0.05525	0.438	0.066	5.15	0.07675	3.07	0.0875	0.767	0.09825	1.53
0.0555	0.767	0.06625	5.91	0.077	2.85	0.08775	0.767	0.0985	1.53
0.05575	1.21	0.0665	6.24	0.07725	2.85	0.088	2.74	0.09875	1.32
0.056	2.63	0.06675	6.57	0.0775	2.74	0.08825	3.94	0.099	1.21
0.05625	5.36	0.067	6.57	0.07775	2.52	0.0885	3.83	0.09925	0.877
0.0565	8.86	0.06725	6.57	0.078	2.52	0.08875	3.29	0.0995	0.767
0.05675	10.93	0.0675	6.24	0.07825	2.3	0.089	3.5	0.09975	0.767
0.057	11.8	0.06775	6.13	0.0785	2.19	0.08925	3.83	0.1	1.21
0.05725	12.34	0.068	5.91	0.07875	1.97	0.0895	4.16	0.10025	1.32
0.0575	12.02	0.06825	5.58	0.079	1.86	0.08975	4.27	0.1005	1.21
0.05775	10.49	0.0685	5.69	0.07925	1.86	0.09	4.49	0.10075	1.1
0.058	8.09	0.06875	5.36	0.0795	1.97	0.09025	4.6	0.101	1.1
0.05825	6.24	0.069	5.15	0.07975	2.3	0.0905	4.71	0.10125	1.21
0.0585	5.36	0.06925	4.49	0.08	2.41	0.09075	4.49	0.1015	1.64
0.05875	5.47	0.0695	4.27	0.08025	2.52	0.091	4.27	0.10175	1.64
0.059	5.91	0.06975	3.61	0.0805	2.63	0.09125	4.05	0.102	1.64
0.05925	6.13	0.07	2.85	0.08075	2.74	0.0915	3.83	0.10225	1.75
0.0595	6.35	0.07025	2.3	0.081	2.96	0.09175	3.83	0.1025	1.86
0.05975	6.89	0.0705	1.97	0.08125	2.85	0.092	3.4	0.10275	1.97
0.06	7.55	0.07075	1.75	0.0815	3.29	0.09225	3.5	0.103	2.08
0.06025	8.09	0.071	1.42	0.08175	3.61	0.0925	3.4	0.10325	1.97
0.0605	8.53	0.07125	1.21	0.082	3.61	0.09275	3.07	0.1035	1.75
0.06075	8.64	0.0715	1.1	0.08225	3.61	0.093	2.96	0.10375	1.64
0.061	8.42	0.07175	0.877	0.0825	3.72	0.09325	2.63	0.104	1.64
0.06125	8.2	0.072	1.1	0.08275	4.16	0.0935	2.52	0.10425	1.75
0.0615	7.66	0.07225	1.21	0.083	4.16	0.09375	2.63	0.1045	1.75
0.06175	7	0.0725	1.32	0.08325	3.83	0.094	2.52	0.10475	1.86
0.062	6.13	0.07275	1.53	0.0835	3.61	0.09425	2.3	0.105	2.08
0.06225	5.25	0.073	1.86	0.08375	3.18	0.0945	2.19	0.10525	2.08
0.0625	4.38	0.07325	2.3	0.084	3.72	0.09475	2.08	0.1055	1.97
0.06275	3.61	0.0735	2.41	0.08425	4.05	0.095	1.75	0.10575	1.75
0.063	3.07	0.07375	2.41	0.0845	4.6	0.09525	1.75	0.106	1.32
0.06325	2.63	0.074	2.52	0.08475	5.36	0.0955	1.64	0.10625	1.1
0.0635	2.3	0.07425	2.74	0.085	4.49	0.09575	1.53	0.1065	0.658



Gauge15_3 Time msec	Gauge15_3 Stress MPa	Gauge15_3 Time msec	Gauge15_3 Stress MPa	Gauge15_4 Time msec	Gauge15_4 Stress MPa	Gauge15_4 Time msec	Gauge15_4 Stress MPa	Gauge15_4 Time msec	Gauge15_4 Stress MPa
0.10675	0.438	0.1175	1.485	0.074	0.111	0.08475	0.498	0.0955	0.719
0.107	1.21	0.11775	8.64	0.07425	0.166	0.085	0.553	0.09575	0.719
0.10725	1.21	0.118	4.27	0.0745	0.111	0.08525	0.553	0.096	0.719
0.1075	0.658	0.11825	2.52	0.07475	0.111	0.0855	0.553	0.09625	0.775
0.10775	0.548	0.1185	3.4	0.075	0.111	0.08575	0.609	0.0965	0.719
0.108	0.658	0.11875	3.94	0.07525	0.111	0.086	0.609	0.09675	0.719
0.10825	0.658	0.119	3.61	0.0755	0.221	0.08625	0.609	0.097	0.664
0.1085	0.329	0.11925	3.5	0.07575	0.221	0.0865	0.664	0.09725	0.609
0.10875	0.438	0.1195	3.4	0.076	0.221	0.08675	0.664	0.0975	0.609
0.109	0.767	0.11975	2.3	0.07625	0.221	0.087	0.664	0.09775	0.664
0.10925	1.42	0.12	4.93	0.0765	0.221	0.08725	0.664	0.098	0.664
0.1095	0.767	0.12025	3.07	0.07675	0.277	0.0875	0.609	0.09825	0.996
0.10975	0.548	0.1205	2.3	0.077	0.277	0.08775	0.609	0.0985	0.055
0.11	0.658	0.12075	2.08	0.07725	0.277	0.088	0.664	0.09875	0.443
0.11025	0.877	0.121	2.3	0.0775	0.277	0.08825	0.664	0.099	0
0.1105	1.53	0.12125	3.18	0.07775	0.332	0.0885	0.719	0.09925	0.332
0.11075	1.53	0.1215	1.97	0.078	0.332	0.08875	0.664	0.0995	0.221
0.111	1.21	0.12175	1.42	0.07825	0.332	0.089	0.719	0.09975	0
0.11125	1.42	0.122	1.32	0.0785	0.332	0.08925	0.719	0.1	-0.055
0.1115	1.86	0.12225	0.548	0.07875	0.332	0.0895	0.664	0.10025	0.221
0.11175	1.97	0.1225	0.329	0.079	0.387	0.08975	0.664	0.1005	-0.111
0.112	1.97	0.12275	1.1	0.07925	0.387	0.09	0.664	0.10075	0.221
0.11225	1.75	0.123	0.438	0.0795	0.387	0.09025	0.664	0.101	0.055
0.1125	1.86	0.12325	-1.54	0.07975	0.332	0.0905	0.664	0.10125	0.221
0.11275	2.19	0.1235	-1.54	0.08	0.443	0.09075	0.775	0.1015	0.111
0.113	3.18	0.12375	-1.65	0.08025	0.387	0.091	0.664	0.10175	0.055
0.11325	2.85	0.124	-1.32	0.0805	0.387	0.09125	0.664	0.102	-0.111
0.1135	2.41	0.12425	-0.987	0.08075	0.443	0.0915	0.719	0.10225	0.166
0.11375	4.27	0.1245	-1.43	0.081	0.443	0.09175	0.664	0.1025	0.443
0.114	3.5	0.12475	-1.75	0.08125	0.498	0.092	0.719	0.10275	0.941
0.11425	2.41	0.125	-1.1	0.0815	0.387	0.09225	0.719	0.103	2.05
0.1145	3.07	0.12525	-2.96	0.08175	0.332	0.0925	0.719	0.10325	3.7
0.11475	4.05	0.1255	-4.83	0.082	0.443	0.09275	0.775	0.1035	5.3
0.115	3.72			0.08225	0.332	0.093	0.719	0.10375	8.12
0.11525	3.83			0.0825	0.498	0.09325	0.719	0.104	9.44
0.1155	3.72			0.08275	0.443	0.0935	0.719	0.10425	9.49
0.11575	4.27			0.083	0.498	0.09375	0.664	0.1045	9.44
0.116	5.8			0.08325	0.498	0.094	0.719	0.10475	9.44
0.11625	6.67			0.0835	0.498	0.09425	0.719	0.105	9.49
0.1165	5.36			0.08375	0.498	0.0945	0.719	0.10525	9.44
0.11675	4.38			0.084	0.498	0.09475	0.719	0.1055	9.44
0.117	4.49			0.08425	0.553	0.095	0.719	0.10575	9.44
0.11725	4.93			0.0845	0.498	0.09525	0.719	0.106	9.44

Gauge15_4 Time msec	Gauge15_4 Stress MPa	Gauge15_4 Time msec	Gauge15_4 Stress MPa	Gauge15_4 Time msec	Gauge15_4 Stress MPa	Gauge15_4 Time msec	Gauge15_4 Stress MPa	Gauge15_4 Time msec	Gauge15_4 Stress MPa
0.10625	9.44	0.117	6.63	0.12775	6.79	0.1385	7.62	0.14925	9.22
0.1065	9.44	0.11725	6.79	0.128	6.79	0.13875	7.57	0.1495	9.22
0.10675	9.33	0.1175	7.62	0.12825	6.74	0.139	6.9	0.14975	9.22
0.107	9	0.11775	7.29	0.1285	6.74	0.13925	6.3	0.15	9.22
0.10725	8.89	0.118	6.9	0.12875	6.9	0.1395	6.57	0.15025	9.22
0.1075	8.61	0.11825	6.79	0.129	6.74	0.13975	7.35	0.1505	9
0.10775	8.45	0.1185	6.79	0.12925	6.57	0.14	7.4	0.15075	9.22
0.108	8.28	0.11875	6.85	0.1295	5.86	0.14025	8.61	0.151	8.23
0.10825	8.23	0.119	7.18	0.12975	4.97	0.1405	8.94	0.15125	7.4
0.1085	8.12	0.11925	7.12	0.13	5.75	0.14075	7.35	0.1515	7.95
0.10875	8.06	0.1195	7.07	0.13025	7.12	0.141	7.57	0.15175	7.79
0.109	8.12	0.11975	7.18	0.1305	6.85	0.14125	8.12	0.152	7.51
0.10925	8.01	0.12	7.29	0.13075	6.96	0.1415	7.4	0.15225	7.84
0.1095	8.01	0.12025	7.29	0.131	7.4	0.14175	6.46	0.1525	7.07
0.10975	8.06	0.1205	7.23	0.13125	7.51	0.142	8.17	0.15275	8.5
0.11	8.06	0.12075	7.18	0.1315	7.57	0.14225	7.84	0.153	7.29
0.11025	8.12	0.121	7.23	0.13175	7.95	0.1425	7.46	0.15325	5.75
0.1105	8.17	0.12125	7.4	0.132	9.33	0.14275	8.17	0.1535	6.85
0.11075	7.9	0.1215	7.46	0.13225	8.89	0.143	6.9	0.15375	6.02
0.111	7.84	0.12175	7.51	0.1325	7.18	0.14325	7.18	0.154	4.92
0.11125	7.4	0.122	7.51	0.13275	5.69	0.1435	8.39	0.15425	7.07
0.1115	7.23	0.12225	7.51	0.133	8.45	0.14375	7.68	0.1545	8.72
0.11175	7.46	0.1225	7.68	0.13325	9.33	0.144	6.63	0.15475	7.07
0.112	7.4	0.12275	7.62	0.1335	4.97	0.14425	6.96	0.155	4.2
0.11225	7.18	0.123	7.68	0.13375	7.79	0.1445	7.01	0.15525	7.12
0.1125	6.96	0.12325	7.84	0.134	5.75	0.14475	7.01	0.1555	3.98
0.11275	6.85	0.1235	7.84	0.13425	5.8	0.145	9.27	0.15575	4.81
0.113	6.68	0.12375	7.9	0.1345	6.85	0.14525	9.27	0.156	5.36
0.11325	6.46	0.124	7.9	0.13475	9	0.1455	6.46	0.15625	3.65
0.1135	6.46	0.12425	7.9	0.135	7.62	0.14575	6.96	0.1565	5.14
0.11375	6.3	0.1245	7.62	0.13525	5.8	0.146	6.46	0.15675	6.02
0.114	6.19	0.12475	7.51	0.1355	6.02	0.14625	5.86	0.157	5.64
0.11425	6.13	0.125	7.35	0.13575	7.07	0.1465	5.42	0.15725	5.69
0.1145	6.13	0.12525	7.4	0.136	7.51	0.14675	5.3	0.1575	5.47
0.11475	6.35	0.1255	7.29	0.13625	7.4	0.147	4.04	0.15775	5.97
0.115	6.35	0.12575	7.12	0.1365	5.86	0.14725	5.08	0.158	6.68
0.11525	6.19	0.126	7.01	0.13675	5.14	0.1475	8.94	0.15825	5.69
0.1155	6.24	0.12625	6.9	0.137	6.41	0.14775	9.16	0.1585	4.09
0.11575	6.19	0.1265	6.74	0.13725	6.74	0.148	8.45	0.15875	4.37
0.116	6.24	0.12675	6.74	0.1375	7.95	0.14825	7.73	0.159	4.26
0.11625	6.3	0.127	6.85	0.13775	8.01	0.1485	9.27	0.15925	4.81
0.1165	6.46	0.12725	6.74	0.138	8.34	0.14875	9.27	0.1595	5.47
0.11675	6.52	0.1275	6.74	0.13825	8.23	0.149	9.22	0.15975	6.19

Gauge15_4 Time msec	Gauge15_4 Stress MPa	Gauge15_4 Time msec	Gauge15_4 Stress MPa	Gauge15_4 Time msec	Gauge15_4 Stress MPa	Gauge15_4 Time msec	Gauge15_4 Stress MPa	Gauge15_4 Time msec	Gauge15_4 Stress MPa
0.16	5.97	0.17075	9	0.1815	5.46	0.19225	9	0.203	5.8
0.16025	6.35	0.171	9.11	0.18175	5.64	0.1925	9	0.20325	7.07
0.1605	5.47	0.17125	8.94	0.182	5.64	0.19275	9	0.2035	6.9
0.16075	4.48	0.1715	7.07	0.18225	6.96	0.193	5.69	0.20375	6.3
0.161	4.37	0.17175	7.79	0.1825	6.63	0.19325	5.47	0.204	6.13
0.16125	4.48	0.172	7.95	0.18275	6.85	0.1935	5.91	0.20425	-4.54
0.1615	5.19	0.17225	8.45	0.183	6.46	0.19375	5.03	0.2045	-0.83
0.16175	6.85	0.1725	8.83	0.18325	7.57	0.194	4.92	0.20475	5.03
0.162	7.01	0.17275	8.28	0.1835	8.06	0.19425	5.3	0.205	5.75
0.16225	6.74	0.173	8.56	0.18375	7.46	0.1945	5.47	0.20525	-1.44
0.1625	6.85	0.17325	8.83	0.184	6.96	0.19475	5.53	0.2055	0.775
0.16275	6.74	0.1735	8.5	0.18425	6.41	0.195	4.37	0.20575	5.42
0.163	6.85	0.17375	7.4	0.1845	6.19	0.19525	4.48	0.206	6.02
0.16325	8.94	0.174	7.01	0.18475	6.19	0.1955	4.48	0.20625	5.64
0.1635	9.16	0.17425	6.79	0.185	5.97	0.19575	3.81	0.2065	5.64
0.16375	7.46	0.1745	6.85	0.18525	5.97	0.196	2.32	0.20675	5.97
0.164	7.01	0.17475	7.29	0.1855	5.86	0.19625	2.93	0.207	5.25
0.16425	7.35	0.175	6.5	0.18575	6.08	0.1965	0.221	0.20725	5.75
0.1645	7.73	0.17525	8.78	0.186	5.97	0.19675	1.83	0.2075	5.97
0.16475	8.28	0.1755	8.12	0.18625	5.8	0.197	3.7	0.20775	6.08
0.165	8.61	0.17575	8.45	0.1865	5.03	0.19725	2.93	0.208	6.24
0.16525	6.96	0.176	9.11	0.18675	5.3	0.1975	2.82	0.20825	6.19
0.1655	6.9	0.17625	9.05	0.187	5.75	0.19775	2.27	0.2085	4.46
0.16575	8.28	0.1765	9.11	0.18725	6.24	0.198	2.65	0.20875	5.91
0.166	8.5	0.17675	7.51	0.1875	4.64	0.19825	3.59	0.209	5.64
0.16625	8.78	0.177	6.96	0.18775	4.59	0.1985	3.76	0.20925	5.3
0.1665	8.23	0.17725	7.68	0.188	5.3	0.19875	2.43	0.2095	5.19
0.16675	9.16	0.1775	7.4	0.18825	5.53	0.199	4.42	0.20975	5.42
0.167	7.9	0.17775	7.46	0.1885	5.58	0.19925	5.58	0.21	4.92
0.16725	7.84	0.178	7.01	0.18875	5.64	0.1995	5.42	0.21025	5.08
0.1675	6.17	0.17825	6.46	0.189	5.86	0.19975	4.92	0.2105	5.47
0.16775	8.12	0.1785	6.63	0.18925	6.02	0.2	4.04	0.21075	8.94
0.168	8.01	0.17875	7.07	0.1895	7.07	0.20025	4.64	0.211	5.86
0.16825	7.18	0.179	8.83	0.18975	6.57	0.2005	-2.82	0.21125	4.97
0.1685	8.17	0.17925	9.05	0.19	5.64	0.20075	-0.332	0.2115	4.92
0.16875	8.34	0.1795	8.61	0.19025	5.58	0.201	2.93	0.21175	5.69
0.169	8.67	0.17975	7.4	0.1905	5.75	0.20125	5.03	0.212	6.35
0.16925	8.34	0.18	8.28	0.19075	6.46	0.2015	5.64	0.21225	5.58
0.1695	8.28	0.18025	7.35	0.191	6.3	0.20175	5.58	0.2125	4.42
0.16975	8.17	0.1805	5.75	0.19125	5.97	0.202	6.08	0.21275	4.97
0.17	7.46	0.18075	6.52	0.1915	6.08	0.20225	5.69	0.213	5.8
0.17025	8.28	0.181	6.63	0.19175	7.4	0.2025	5.03	0.21325	5.47
0.1705	8.45	0.18125	7.95	0.192	8.78	0.20275	5.47	0.2135	5.19

Gauge15_4 Time msec	Gauge15_4 Stress MPa	Gauge15_4 Time msec	Gauge15_4 Stress MPa	Gauge15_4 Time msec	Gauge15_4 Stress MPa	Gauge15_5 Time msec	Gauge15_5 Stress MPa	Gauge15_5 Time msec	Gauge15_5 Stress MPa
0.21375	4.86	0.228	8.06	0.22675	5.91	0.079	0	0.1005	0.055
0.214	5.08	0.22825	6.63	0.227	6.02	0.0795	0	0.101	0.988
0.21425	4.97	0.2285	5.75	0.22725	7.46	0.08	-0.055	0.1015	5.26
0.2145	5.36	0.22875	5.64	0.2275	8.83	0.0805	0	0.102	7.56
0.21475	6.68	0.229	5.36	0.22775	8.83	0.081	-0.055	0.1025	7.56
0.215	5.75	0.22925	5.08			0.0815	-0.055	0.103	7.51
0.21525	5.25	0.2295	4.7			0.082	0.055	0.1035	7.51
0.2155	5.19	0.22975	4.42			0.0825	0.055	0.104	7.56
0.21575	5.19	0.23	4.09			0.083	0.055	0.1045	7.51
0.216	5.14	0.23025	3.92			0.0835	0.055	0.105	6.63
0.21625	5.42	0.2305	3.76			0.084	0	0.1055	5.98
0.2165	5.42	0.23075	3.7			0.0845	0.055	0.106	5.43
0.21675	5.36	0.231	3.92			0.085	0.055	0.1065	4.33
0.217	5.19	0.23125	3.87			0.0855	0.055	0.107	3.51
0.21725	5.91	0.2315	3.7			0.086	0.055	0.1075	3.13
0.2175	6.13	0.23175	3.54			0.0865	0	0.108	3.24
0.21775	5.47	0.232	3.54			0.087	0.055	0.1085	3.18
0.218	5.3	0.23225	3.37			0.0875	0.055	0.109	3.24
0.21825	5.3	0.2325	3.43			0.088	0.055	0.1095	3.07
0.2185	5.47	0.23275	3.54			0.0885	0.11	0.11	2.96
0.21875	5.91	0.233	3.54			0.089	0.329	0.1105	3.29
0.219	6.13	0.23325	3.21			0.0895	0.11	0.111	3.35
0.21925	6.57	0.2335	3.59			0.09	0.11	0.1115	2.91
0.2195	6.24	0.23375	3.32			0.0905	0.055	0.112	2.8
0.21975	5.69	0.234	2.93			0.091	0.165	0.1125	2.8
0.22	5.47	0.23425	3.04			0.0915	0.055	0.113	2.74
0.22025	5.36	0.2345	2.93			0.092	0.11	0.1135	2.47
0.2205	5.08	0.23475	2.71			0.0925	0.11	0.114	2.25
0.22075	5.91	0.235	2.71			0.093	0.275	0.1145	1.87
0.221	5.97	0.23525	2.65			0.0935	0.165	0.115	1.76
0.22125	5.8	0.2355	2.76			0.094	0.549	0.1155	1.65
0.2215	5.58	0.23575	2.88			0.0945	0.11	0.116	1.7
0.22175	5.42	0.236	2.54			0.095	0.329	0.1165	1.76
0.222	5.42	0.23625	2.32			0.0955	0.11	0.117	1.65
0.22225	6.41	0.2245	5.58			0.096	0.055	0.1175	1.65
0.2225	5.75	0.22475	5.69			0.0965	0	0.118	1.7
0.22275	5.42	0.225	5.42			0.097	0	0.1185	2.14
0.223	5.42	0.22525	5.36			0.0975	0.11	0.119	1.98
0.22325	5.47	0.2255	5.42			0.098	-0.275	0.1195	1.65
0.2235	5.58	0.22575	5.42			0.0985	-0.165	0.12	1.98
0.22375	5.53	0.226	5.53			0.099	-0.275	0.1205	2.03
0.224	5.42	0.22625	5.91			0.0995	-0.33	0.121	2.14
0.22425	5.36	0.2265	6.08			0.1	-0.165	0.1215	2.25

Gauge15_5 Time msec	Gauge15_5 Stress MPa	Gauge15_5 Time msec	Gauge15_5 Stress MPa	Gauge15_5 Time msec	Gauge15_5 Stress MPa	Gauge15_5 Time msec	Gauge15_5 Stress MPa	Gauge15_6 Time msec	Gauge15_6 Stress MPa
0.122	2.31	0.1435	3.24	0.165	3.57	0.1865	2.85	0.139	-0.306
0.1225	2.47	0.144	3.84	0.1655	3.57	0.187	2.03	0.13925	-0.284
0.123	2.47	0.1445	3.18	0.166	4.22	0.1875	2.25	0.1395	-0.306
0.1235	2.47	0.145	2.96	0.1665	4.99	0.188	2.25	0.13975	-0.306
0.124	2.31	0.1455	0.275	0.167	4.17	0.1885	-2.64	0.14	-0.328
0.1245	2.58	0.146	3.18	0.1675	4.06	0.189	2.52	0.14025	-0.328
0.125	2.8	0.1465	2.85	0.168	5.43	0.1895	1.81	0.1405	-0.306
0.1255	2.96	0.147	2.63	0.1685	4.77	0.19	0.275	0.14075	-0.284
0.126	2.96	0.1475	0.11	0.169	5.48	0.1905	1.32	0.141	-0.284
0.1265	2.96	0.148	2.47	0.1695	4.17	0.191	0.659	0.14125	-0.262
0.127	2.96	0.1485	2.58	0.17	3.51	0.1915	2.25	0.1415	-0.262
0.1275	2.52	0.149	3.24	0.1705	3.35	0.192	2.74	0.14175	-0.262
0.128	2.69	0.1495	2.74	0.171	3.07	0.1925	2.85	0.142	-0.262
0.1285	2.91	0.15	2.09	0.1715	2.91	0.193	2.96	0.14225	-0.262
0.129	3.02	0.1505	1.98	0.172	2.31	0.1935	2.25	0.1425	-0.262
0.1295	2.85	0.151	5.81	0.1725	1.76	0.194	0.714	0.14275	-0.284
0.13	2.69	0.1515	2.41	0.173	2.52	0.1945	1.54	0.143	-0.262
0.1305	2.52	0.152	0.879	0.1735	1.92	0.195	1.76	0.14325	-0.262
0.131	2.47	0.1525	2.03	0.174	2.31	0.1955	2.47	0.1435	-0.262
0.1315	2.36	0.153	2.85	0.1745	1.92	0.196	2.25	0.14375	-0.24
0.132	1.87	0.1535	0.494	0.175	2.58	0.1965	2.52	0.144	-0.218
0.1325	1.98	0.154	2.63	0.1755	0.659	0.197	2.74	0.14425	-0.262
0.133	1.76	0.1545	2.2	0.176	3.07	0.1975	2.2	0.1445	-0.218
0.1335	2.85	0.155	3.57	0.1765	2.2	0.198	2.2	0.14475	-0.218
0.134	2.2	0.1555	3.24	0.177	2.63	0.1985	2.36	0.145	-0.24
0.1345	3.51	0.156	2.25	0.1775	0.879	0.199	2.14	0.14525	-0.24
0.135	3.84	0.1565	4.55	0.178	1.81	0.1995	2.25	0.1455	-0.24
0.1355	2.25	0.157	2.91	0.1785	4.22	0.2	1.92	0.14575	-0.24
0.136	-0.33	0.1575	3.35	0.179	2.69	0.2005	2.91	0.146	-0.24
0.1365	7.18	0.158	3.46	0.1795	3.13	0.201	1.92	0.14625	-0.24
0.137	1.26	0.1585	2.8	0.18	4.06	0.2015	1.87	0.1465	-0.197
0.1375	2.8	0.159	2.96	0.1805	5.15	0.202	4.94	0.14675	-0.197
0.138	3.51	0.1595	3.62	0.181	3.73	0.2025	2.8	0.147	-0.175
0.1385	4.83	0.16	1.1	0.1815	3.95	0.203	2.47	0.14725	-0.175
0.139	-0.714	0.1605	2.52	0.182	5.7	0.2035	2.03	0.1475	-0.175
0.1395	2.85	0.161	2.52	0.1825	6.41	0.204	2.14	0.14775	-0.175
0.14	2.41	0.1615	3.4	0.183	5.98	0.2045	1.98	0.148	-0.175
0.1405	0.055	0.162	1.48	0.1835	5.1	0.205	1.87	0.14825	-0.153
0.141	2.25	0.1625	2.69	0.184	3.35	0.2055	1.92	0.1485	-0.153
0.1415	2.63	0.163	3.4	0.1845	3.57	0.206	1.15	0.14875	-0.153
0.142	2.41	0.1635	3.62	0.185	2.8	0.2065	1.54	0.149	-0.131
0.1425	1.04	0.164	4.06	0.1855	2.8	0.207	1.81	0.14925	-0.153
0.143	3.95	0.1645	4.06	0.186	3.02	0.2075	1.65	0.1495	-0.131

Gauge15_6 Time msec	Gauge15_6 Stress MPa	Gauge15_6 Time msec	Gauge15_6 Stress MPa	Gauge15_6 Time msec	Gauge15_6 Stress MPa	Gauge15_6 Time msec	Gauge15_6 Stress MPa	Gauge15_6 Time msec	Gauge15_6 Stress MPa
0.14975	-0.131	0.1605	0.044	0.17125	3.47	0.182	2.84	0.19275	2.66
0.15	-0.153	0.16075	0.044	0.1715	3.47	0.18225	2.64	0.193	2.51
0.15025	-0.153	0.161	0.066	0.17175	3.47	0.1825	2.44	0.19325	2.38
0.1505	-0.131	0.16125	0.153	0.172	3.47	0.18275	2.23	0.1935	2.23
0.15075	-0.131	0.1615	0.328	0.17225	3.47	0.183	2.05	0.19375	1.96
0.151	-0.109	0.16175	0.546	0.1725	3.47	0.18325	1.72	0.194	2.23
0.15125	-0.087	0.162	0.939	0.17275	3.3	0.1835	1.68	0.19425	2.36
0.1515	-0.087	0.16225	1.57	0.173	3.32	0.18375	1.03	0.1945	2.38
0.15175	-0.109	0.1625	2.4	0.17325	3.34	0.184	0.83	0.19475	2.31
0.152	-0.066	0.16275	3.1	0.1735	3.34	0.18425	0.786	0.195	2.38
0.15225	-0.066	0.163	3.53	0.17375	3.4	0.1845	0.895	0.19525	2.34
0.1525	-0.087	0.16325	3.53	0.174	3.45	0.18475	0.437	0.1955	2.29
0.15275	-0.066	0.1635	3.53	0.17425	3.45	0.185	0.721	0.19575	2.34
0.153	-0.066	0.16375	3.53	0.1745	2.99	0.18525	0.175	0.196	2.42
0.15325	-0.087	0.164	3.51	0.17475	3.4	0.1855	0.087	0.19625	2.42
0.1535	-0.087	0.16425	3.53	0.175	3.43	0.18575	-0.568	0.1965	2.36
0.15375	-0.044	0.1645	3.53	0.17525	3.45	0.186	-0.262	0.19675	2.34
0.154	-0.044	0.16475	3.53	0.1755	3.43	0.18625	0.917	0.197	2.36
0.15425	-0.066	0.165	3.51	0.17575	3.43	0.1865	0.83	0.19725	2.36
0.1545	-0.044	0.16525	3.51	0.176	3.27	0.18675	1.11	0.1975	2.34
0.15475	-0.022	0.1655	3.51	0.17625	3.08	0.187	1.42	0.19775	2.27
0.155	-0.066	0.16575	3.49	0.1765	2.95	0.18725	0.087	0.198	2.2
0.15525	-0.044	0.166	3.49	0.17675	3.01	0.1875	0.611	0.19825	2.18
0.1555	-0.044	0.16625	3.51	0.177	3.23	0.18775	0.852	0.1985	2.18
0.15575	-0.066	0.1665	3.49	0.17725	3.34	0.188	1.24	0.19875	2.18
0.156	-0.044	0.16675	3.49	0.1775	3.36	0.18825	1.51	0.199	2.23
0.15625	-0.022	0.167	3.49	0.17775	3.4	0.1885	2.64	0.19925	2.31
0.1565	0	0.16725	3.49	0.178	3.43	0.18875	2.86	0.1995	2.4
0.15675	-0.022	0.1675	3.49	0.17825	3.38	0.189	2.36	0.19975	2.44
0.157	0.022	0.16775	3.51	0.1785	3.4	0.18925	2.55	0.2	2.44
0.15725	0.022	0.168	3.49	0.17875	3.4	0.1895	3.34	0.20025	2.47
0.1575	0	0.16825	3.49	0.179	3.4	0.18975	3.34	0.2005	2.38
0.15775	0.022	0.1685	3.49	0.17925	3.43	0.19	2.62	0.20075	2.38
0.158	0.022	0.16875	3.49	0.1795	3.43	0.19025	2.68	0.201	2.38
0.15825	0	0.169	3.47	0.17975	3.4	0.1905	2.82	0.20125	2.38
0.1585	0	0.16925	3.49	0.18	3.4	0.19075	3.16	0.2015	2.34
0.15875	0.044	0.1695	3.47	0.18025	3.4	0.191	3.19	0.20175	2.36
0.159	0.022	0.16975	3.47	0.1805	3.4	0.19125	3.06	0.202	2.36
0.15925	0.022	0.17	3.47	0.18075	3.1	0.1915	2.97	0.20225	2.49
0.1595	0.022	0.17025	3.47	0.181	3.14	0.19175	2.92	0.2025	2.55
0.15975	0.022	0.1705	3.47	0.18125	3.16	0.192	2.99	0.20275	2.6
0.16	0	0.17075	3.47	0.1815	2.99	0.19225	2.75	0.203	2.64
0.16025	0.022	0.171	3.47	0.18175	2.88	0.1925	2.64	0.20325	2.68

Gauge15_6 Time msec	Gauge15_6 Stress MPa	Gauge15_6 Time msec	Gauge15_6 Stress MPa
0.2035	2.66	0.21425	1
0.20375	2.75	0.2145	1.18
0.204	2.77	0.21475	1.29
0.20425	2.77	0.215	2.01
0.2045	2.77	0.21525	1.2
0.20475	2.82	0.2155	0.961
0.205	2.99	0.21575	0.371
0.20525	3.14	0.216	-0.109
0.2055	3.01	0.21625	-0.284
0.20575	2.9	0.2165	-0.306
0.206	2.86	0.21675	0.24
0.20625	2.86	0.217	0.24
0.2065	2.86	0.21725	-0.677
0.20675	2.88		
0.207	2.88		
0.20725	2.73		
0.2075	2.88		
0.20775	2.95		
0.208	2.77		
0.20825	3.21		
0.2085	3.21		
0.20875	3.21		
0.209	1.68		
0.20925	2.51		
0.2095	3.1		
0.20975	2.97		
0.21	2.92		
0.21025	2.58		
0.2105	2.18		
0.21075	1.57		
0.211	3.21		
0.21125	3.19		
0.2115	2.2		
0.21175	2.34		
0.212	2.31		
0.21225	2.14		
0.2125	1.9		
0.21275	2.1		
0.213	2.2		
0.21325	2.03		
0.2135	1.53		
0.21375	1.31		
0.214	1.2		

Gauge16_1 Time msec	Gauge16_1 Stress MPa	Gauge16_1 Time msec	Gauge16_1 Stress MPa	Gauge16_1 Time msec	Gauge16_1 Stress MPa	Gauge16_1 Time msec	Gauge16_1 Stress MPa	Gauge16_1 Time msec	Gauge16_1 Stress MPa
-0.03025	17.28	-0.0195	17.28	-0.00875	34.39	0.002	932.94	0.01275	-17.45
-0.03	0	-0.01925	34.39	-0.0085	17.28	0.00225	932.94	0.013	0
-0.02975	17.28	-0.019	34.39	-0.00825	34.39	0.0025	847.02	0.01325	17.28
-0.0295	17.28	-0.01875	17.28	-0.008	17.28	0.00275	763.9	0.0135	17.28
-0.02925	0	-0.0185	0	-0.00775	34.39	0.003	723.6	0.01375	0
-0.029	34.39	-0.01825	34.39	-0.0075	0	0.00325	608.7	0.014	-17.45
-0.02875	34.39	-0.018	17.28	-0.00725	17.28	0.0035	504.32	0.01425	-17.45
-0.0285	17.28	-0.01775	0	-0.007	17.28	0.00375	441.28		
-0.02825	0	-0.0175	17.28	-0.00675	0	0.004	472.12		
-0.028	0	-0.01725	17.28	-0.0065	17.28	0.00425	504.32		
-0.02775	0	-0.017	17.28	-0.00625	17.28	0.0045	383.67		
-0.0275	34.39	-0.01675	17.28	-0.006	34.39	0.00475	283.15		
-0.02725	17.28	-0.0165	17.28	-0.00575	34.39	0.005	238.01		
-0.027	17.28	-0.01625	17.28	-0.0055	0	0.00525	215.84		
-0.02675	17.28	-0.016	17.28	-0.00525	17.28	0.0055	193.43		
-0.0265	17.28	-0.01575	17.28	-0.005	17.28	0.00575	215.84		
-0.02625	17.28	-0.0155	0	-0.00475	0	0.006	193.43		
-0.026	0	-0.01525	17.28	-0.0045	17.28	0.00625	57.78		
-0.02575	34.39	-0.015	34.39	-0.00425	17.28	0.0065	90.48		
-0.0255	17.28	-0.01475	17.28	-0.004	17.28	0.00675	57.78		
-0.02525	0	-0.0145	17.28	-0.00375	17.28	0.007	34.39		
-0.025	0	-0.01425	17.28	-0.0035	17.28	0.00725	90.48		
-0.02475	17.28	-0.014	34.39	-0.00325	0	0.0075	90.48		
-0.0245	17.28	-0.01375	17.28	-0.003	17.28	0.00775	119.56		
-0.02425	0	-0.0135	0	-0.00275	17.28	0.008	145.91		
-0.024	17.28	-0.01325	17.28	-0.0025	34.39	0.00825	57.78		
-0.02375	0	-0.013	34.39	-0.00225	17.28	0.0085	57.78		
-0.0235	34.39	-0.01275	17.28	-0.002	17.28	0.00875	17.28		
-0.02325	17.28	-0.0125	0	-0.00175	17.28	0.009	-17.45		
-0.023	17.28	-0.01225	17.28	-0.0015	17.28	0.00925	-17.45		
-0.02275	17.28	-0.012	0	-0.00125	0	0.0095	17.28		
-0.0225	34.39	-0.01175	17.28	-0.001	0	0.00975	57.78		
-0.02225	34.39	-0.0115	17.28	-0.00075	0	0.01	57.78		
-0.022	0	-0.01125	0	-0.0005	34.39	0.01025	57.78		
-0.02175	17.28	-0.011	17.28	-0.00025	34.39	0.0105	57.78		
-0.0215	17.28	-0.01075	17.28	0	17.28	0.01075	57.78		
-0.02125	0	-0.0105	17.28	0.00025	57.78	0.011	34.39		
-0.021	17.28	-0.01025	17.28	0.0005	170.31	0.01125	17.28		
-0.02075	0	-0.01	17.28	0.00075	283.15	0.0115	34.39		
-0.0205	0	-0.00975	0	0.001	356.83	0.01175	17.28		
-0.02025	34.39	-0.0095	0	0.00125	763.9	0.012	17.28		
-0.02	0	-0.00925	17.28	0.0015	932.94	0.01225	57.78		
-0.01975	17.28	-0.009	17.28	0.00175	932.94	0.0125	-17.45		

Gauge 16_2	Gauge 16_2	Gauge 16_2	Gauge 16_2	Gauge 16_2	Gauge 16_2	Gauge 16_2	Gauge 16_2	Gauge 16_2	Gauge 16_2
Time	Stress	Time	Stress	Time	Stress	Time	Stress	Time	Stress
msec	MPa	msec	MPa	msec	MPa	msec	MPa	msec	MPa
-0.00275	0.222	0.01875	0.444	0.04025	0.667	0.06175	0.667	0.08325	1.78
-0.00225	0.222	0.01925	0.667	0.04075	0.667	0.06225	-0.222	0.08375	2
-0.00175	0.222	0.01975	0.667	0.04125	0.667	0.06275	-0.667	0.08425	1.78
-0.00125	0	0.02025	0.444	0.04175	0.667	0.06325	-0.667	0.08475	1.55
-0.00075	0.222	0.02075	0.444	0.04225	0.889	0.06375	0	0.08525	0.222
-0.00025	0.222	0.02125	0.444	0.04275	0.889	0.06425	0.889	0.08575	1.11
0.00025	0	0.02175	0.444	0.04325	0.889	0.06475	1.33	0.08625	1.55
0.00075	0	0.02225	0.222	0.04375	0.889	0.06525	1.55	0.08675	1.78
0.00125	0.222	0.02275	0.444	0.04425	0.889	0.06575	2.66	0.08725	1.78
0.00175	0	0.02325	0.222	0.04475	0.667	0.06625	5.55	0.08775	1.33
0.00225	0	0.02375	0.444	0.04525	0.889	0.06675	5.55	0.08825	1.33
0.00275	0.222	0.02425	0.444	0.04575	0.889	0.06725	4.22	0.08875	1.78
0.00325	0	0.02475	0.667	0.04625	0.889	0.06775	3.33	0.08925	1.78
0.00375	0	0.02525	0.667	0.04675	0.889	0.06825	3.11	0.08975	2.89
0.00425	0.222	0.02575	0.667	0.04725	0.667	0.06875	3.55	0.09025	3.11
0.00475	0.222	0.02625	0.444	0.04775	0.889	0.06925	2.66	0.09075	1.55
0.00525	0.222	0.02675	0.667	0.04825	0.889	0.06975	1.78	0.09125	1.33
0.00575	0	0.02725	0.667	0.04875	0.667	0.07025	0.444	0.09175	1.55
0.00625	0	0.02775	0.444	0.04925	0.889	0.07075	0.444	0.09225	2
0.00675	0.222	0.02825	0.444	0.04975	0.667	0.07125	1.11	0.09275	2.66
0.00725	-0.445	0.02875	0.222	0.05025	0.444	0.07175	1.11	0.09325	2.22
0.00775	-0.222	0.02925	0.444	0.05075	0.667	0.07225	0.667	0.09375	2.44
0.00825	-0.222	0.02975	0.444	0.05125	0.444	0.07275	1.78	0.09425	2
0.00875	-0.222	0.03025	0.444	0.05175	0.444	0.07325	2.66	0.09475	2.44
0.00925	-0.445	0.03075	0.444	0.05225	0.222	0.07375	3.11	0.09525	1.78
0.00975	-0.667	0.03125	0.444	0.05275	0.444	0.07425	3.33	0.09575	1.11
0.01025	-0.222	0.03175	0.667	0.05325	0.667	0.07475	3.33	0.09625	-1.11
0.01075	-0.222	0.03225	0.444	0.05375	0.889	0.07525	2.89	0.09675	-0.445
0.01125	-0.445	0.03275	0.444	0.05425	1.33	0.07575	2.89	0.09725	0
0.01175	0	0.03325	0.667	0.05475	3.33	0.07625	2.89	0.09775	-0.889
0.01225	0.444	0.03375	0.667	0.05525	10.63	0.07675	2.66	0.09825	-3.11
0.01275	0	0.03425	0.667	0.05575	18.57	0.07725	1.55	0.09875	3
0.01325	-0.222	0.03475	0.667	0.05625	16.37	0.07775	1.11	0.09925	4.77
0.01375	0	0.03525	0.667	0.05675	7.1	0.07825	1.33	0.09975	-1.78
0.01425	0.444	0.03575	0.444	0.05725	3.77	0.07875	2	0.10025	-2.67
0.01475	-2.67	0.03625	0.444	0.05775	4	0.07925	1.33	0.10075	1.33
0.01525	-0.445	0.03675	0.667	0.05825	4.66	0.07975	2	0.10125	2.44
0.01575	0	0.03725	0.667	0.05875	4.66	0.08025	2	0.10175	0.444
0.01625	0.222	0.03775	0.667	0.05925	4.88	0.08075	2	0.10225	-1.33
0.01675	0	0.03825	0.667	0.05975	4.88	0.08125	1.78	0.10275	0.222
0.01725	0.222	0.03875	0.667	0.06025	4.22	0.08175	1.33	0.10325	2.44
0.01775	0.222	0.03925	0.667	0.06075	3.33	0.08225	1.11	0.10375	2.44
0.01825	0.222	0.03975	0.667	0.06125	2	0.08275	2.22	0.10425	1.11
Gauge 16_2	Gauge 16_2	Gauge 16_3	Gauge 16_3	Gauge 16_3	Gauge 16_3	Gauge 16_3	Gauge 16_3	Gauge 16_3	Gauge 16_3
Time	Stress	Time	Stress	Time	Stress	Time	Stress	Time	Stress
msec	MPa	msec	MPa	msec	MPa	msec	MPa	msec	MPa
0.10475	0.222	0.026	-0.224	0.03675	-0.224	0.0495	0	0.06025	6.92
0.10525	0.444	0.02625	-0.224	0.039	-0.224	0.04975	0	0.0605	6.69
0.10575	-0.667	0.0285	-0.224	0.03925	-0.224	0.05	0	0.06075	6.25
0.10625	-2.22	0.02875	-0.224	0.0395	-0.224	0.05025	0	0.061	6.02
0.10675	-3.56	0.029	-0.224	0.03975	-0.224	0.0505	0	0.06125	5.58
0.10725	-4	0.02925	-0.224	0.04	0	0.05075	0	0.0615	5.36
0.10775	-5.12	0.0295	-0.224	0.04025	-0.224	0.051	0	0.06175	4.69
0.10825	-4.9	0.02975	-0.224	0.0405	-0.224	0.05125	0	0.062	4.46
0.10875	-3.78	0.03	-0.224	0.04075	-0.224	0.0515	-0.224	0.06225	4.02
0.10925	-3.56	0.03025	-0.224	0.041	-0.224	0.05175	-0.224	0.0625	3.8
0.10975	-5.34	0.0305	-0.224	0.04125	-0.224	0.052	-0.224	0.06275	3.57
0.11025	-5.56	0.03075	-0.224	0.0415	-0.224	0.05225	-0.224	0.063	3.57
0.11075	-5.56	0.031	-0.224	0.04175	0	0.0525	0	0.06325	3.35
0.11125	-5.12	0.03125	-0.224	0.042	-0.224	0.05275	0	0.0635	3.35
0.11175	-5.79	0.0315	-0.224	0.04225	0	0.053	0	0.06375	3.35
0.11225	-5.79	0.03175	-0.224	0.0425	-0.224	0.05325	0	0.064	3.57
		0.032	-0.224	0.04275	0	0.0535	0	0.06425	3.8
		0.03225	-0.224	0.043	0	0.05375	0	0.0645	3.8
		0.0325	-0.224	0.04325	-0.224	0.054	0	0.06475	4.02
		0.03275	-0.224	0.0435	0	0.05425	0	0.065	4.24
		0.033	-0.224	0.04375	0	0.0545	0	0.06525	4.46
		0.03325	-0.224	0.044	-0.224	0.05475	0.447	0.0655	4.46
		0.0335	-0.224	0.04425	0	0.055	1.34	0.06575	4.91
		0.03375	-0.224	0.0445	-0.224	0.05525	2.68	0.066	5.36
		0.034	-0.224	0.04475	-0.224	0.0555	4.91	0.06625	5.8
		0.03425	-0.224	0.045	0	0.05575	8.03	0.0665	6.02
		0.0345	-0.224	0.04525	0	0.056	10.47	0.06675	6.25
		0.03475	-0.224	0.0455	0	0.05625	12.03	0.067	6.02
		0.035	-0.447	0.04575	0	0.0565	12.47	0.06725	6.47
		0.03525	-0.224	0.046	0	0.05675	12.25	0.0675	6.69
		0.0355	-0.224	0.04625	0	0.057	11.59	0.06775	6.92
		0.03575	-0.224	0.0465	0	0.05725	11.59	0.068	7.14
		0.036	-0.224	0.04675	0	0.0575	11.14	0.06825	7.14
		0.03625	-0.224	0.047	0	0.05775	10.47	0.0685	7.14
		0.0365	-0.224	0.04725	0	0.058	9.81	0.06875	7.14
		0.03675	-0.224	0.0475	0	0.05825	9.14	0.069	6.69
		0.037	-0.224	0.04775	0	0.0585	8.47	0.06925	6.47
		0.03725	-0.224	0.048	0	0.05875	7.81	0.0695	5.8
		0.0375	-0.224	0.04825	0	0.059	7.36	0.06975	5.58
		0.03775	-0.224	0.0485	0	0.05925	7.14	0.07	4.91
		0.038	-0.224	0.04875	0	0.0595	6.92	0.07025	4.91
		0.03825	-0.224	0.049	0	0.05975	6.69	0.0705	4.46
		0.0385	-0.224	0.04925	0	0.06	6.92	0.07075	4.24

Gauge16_3 Time msec	Gauge16_3 Stress MPa	Gauge16_3 Time msec	Gauge16_3 Stress MPa	Gauge16_4 Time msec	Gauge16_4 Stress MPa	Gauge16_4 Time msec	Gauge16_4 Stress MPa	Gauge16_4 Time msec	Gauge16_4 Stress MPa
0.071	4.02	0.08175	5.13	0.06975	0	0.0805	0	0.09125	-0.217
0.07125	4.02	0.082	5.36	0.07	0	0.08075	0	0.0915	0
0.0715	3.8	0.08225	4.69	0.07025	0	0.081	-0.217	0.09175	0
0.07175	3.35	0.0825	4.46	0.0705	0	0.08125	0	0.092	0
0.072	3.13	0.08275	4.24	0.07075	0	0.0815	0	0.09225	0
0.07225	3.35	0.083	3.57	0.071	0	0.08175	0	0.0925	0
0.0725	3.13	0.08325	3.13	0.07125	0	0.082	0	0.09275	0
0.07275	3.13	0.0835	3.13	0.0715	0.217	0.08225	0	0.093	0
0.073	3.13	0.08375	3.13	0.07175	0	0.0825	-0.217	0.09325	0
0.07325	3.13	0.084	3.13	0.072	0.217	0.08275	0.217	0.0935	0
0.0735	3.13	0.08425	3.13	0.07225	0.217	0.083	0	0.09375	0
0.07375	3.13	0.0845	3.13	0.0725	0.217	0.08325	0.217	0.094	0
0.074	3.13	0.08475	3.13	0.07275	0.217	0.0835	0	0.09425	0
0.07425	2.68	0.085	2.9	0.073	0	0.08375	0	0.0945	0
0.0745	2.68	0.08525	2.68	0.07325	0	0.084	0	0.09475	0
0.07475	2.46	0.0855	2.68	0.0735	0	0.08425	0	0.095	0
0.075	2.46	0.08575	2.68	0.07375	0	0.0845	0	0.09525	0.217
0.07525	2.46	0.086	2.68	0.074	0.217	0.08475	0	0.0955	0.217
0.0755	2.9	0.08625	2.23	0.07425	0	0.085	0	0.09575	0.217
0.07575	2.9	0.0865	2.01	0.0745	0	0.08525	0	0.096	0.217
0.076	3.13	0.08675	2.68	0.07475	0	0.0855	-0.217	0.09625	0.217
0.07625	3.13	0.087	2.9	0.075	0	0.08575	0	0.0965	0.217
0.0765	3.13	0.08725	2.46	0.07525	0	0.086	0	0.09675	0
0.07675	2.9	0.0875	2.01	0.0755	0	0.08625	0	0.097	0
0.077	3.13	0.08775	1.12	0.07575	0	0.0865	0	0.09725	-0.217
0.07725	3.35	0.088	2.01	0.076	0	0.08675	0	0.0975	-1.08
0.0775	3.35	0.08825	2.68	0.07625	0	0.087	-0.217	0.09775	0
0.07775	3.35	0.0885	1.79	0.0765	0	0.08725	0	0.098	0
0.078	3.8	0.08875	0.67	0.07675	0	0.0875	0	0.09825	-1.74
0.07825	3.8	0.089	-0.447	0.077	0	0.08775	0	0.0985	-1.52
0.0785	4.02	0.08925	-0.894	0.07725	0	0.088	0	0.09875	-0.217
0.07875	3.8	0.0895	4.46	0.0775	0	0.08825	0	0.099	0.434
0.079	4.24	0.08975	5.8	0.07775	0	0.0885	0	0.09925	0.217
0.07925	4.24	0.09	1.79	0.078	0	0.08875	0	0.0995	0.217
0.0795	4.69	0.09025	-0.224	0.07825	0.217	0.089	0	0.09975	0.217
0.07975	4.69	0.0905	-0.671	0.0785	0.217	0.08925	0	0.1	0
0.08	4.69	0.09075	-0.671	0.07875	-0.217	0.0895	0	0.10025	0.217
0.08025	4.69	0.091	0.447	0.079	0	0.08975	0	0.1005	0.217
0.0805	4.91	0.09125	-0.447	0.07925	0	0.09	0	0.10075	0.217
0.08075	5.13	0.0915	-4.48	0.0795	0	0.09025	-0.217	0.101	0.434
0.081	5.58	0.09175	-3.58	0.07975	0	0.0905	0	0.10125	0.434
0.08125	5.36	0.092	1.79	0.08	0	0.09075	0	0.1015	0.434
0.0815	5.13	0.09225	-1.12	0.08025	0	0.091	0	0.10175	0.434

Gauge16_4 Time msec	Gauge16_4 Stress MPa	Gauge16_4 Time msec	Gauge16_4 Stress MPa	Gauge16_4 Time msec	Gauge16_4 Stress MPa	Gauge16_4 Time msec	Gauge16_4 Stress MPa	Gauge16_4 Time msec	Gauge16_4 Stress MPa
0.102	0.217	0.11275	5.41	0.1235	4.33	0.13425	3.9	0.145	3.47
0.10225	0.434	0.113	5.63	0.12375	4.33	0.1345	3.9	0.14525	3.25
0.1025	0.434	0.11325	5.19	0.124	4.33	0.13475	4.11	0.1455	3.25
0.10275	0.217	0.1135	5.41	0.12425	4.11	0.135	3.9	0.14575	3.25
0.103	0.434	0.11375	5.63	0.1245	4.11	0.13525	3.9	0.146	3.25
0.10325	0.217	0.114	5.41	0.12475	3.9	0.1355	3.9	0.14625	3.25
0.1035	0.434	0.11425	4.98	0.125	3.9	0.13575	3.9	0.1465	3.25
0.10375	0.434	0.1145	4.76	0.12525	4.11	0.136	3.9	0.14675	3.47
0.104	0.434	0.11475	4.55	0.1255	3.9	0.13625	3.9	0.147	3.47
0.10425	0.217	0.115	4.55	0.12575	3.9	0.1365	3.9	0.14725	3.47
0.1045	0.217	0.11525	4.76	0.126	4.11	0.13675	3.9	0.1475	3.47
0.10475	0.434	0.1155	4.76	0.12625	4.11	0.137	3.9	0.14775	3.68
0.105	0.434	0.11575	4.55	0.1265	3.9	0.13725	3.9	0.148	3.47
0.10525	0.434	0.116	4.55	0.12675	4.11	0.1375	3.9	0.14825	3.47
0.1055	0.65	0.11625	4.55	0.127	3.9	0.13775	3.68	0.1485	3.47
0.10575	0.65	0.1165	4.11	0.12725	4.11	0.138	3.68	0.14875	3.25
0.106	1.08	0.11675	4.33	0.1275	3.9	0.13825	3.68	0.149	3.25
0.10625	1.95	0.117	4.33	0.12775	3.9	0.1385	3.68	0.14925	3.25
0.1065	2.38	0.11725	3.9	0.128	3.9	0.13875	3.68	0.1495	3.47
0.10675	3.03	0.1175	4.11	0.12825	3.9	0.139	3.68	0.14975	3.47
0.107	3.9	0.11775	3.9	0.1285	3.9	0.13925	3.68	0.15	3.68
0.10725	3.9	0.118	4.11	0.12875	3.9	0.1395	3.25	0.15025	3.68
0.1075	4.33	0.11825	4.11	0.129	3.9	0.13975	3.47	0.1505	3.47
0.10775	5.84	0.1185	4.11	0.12925	3.9	0.14	3.68	0.15075	3.47
0.108	6.71	0.11875	4.11	0.1295	3.9	0.14025	3.47	0.151	3.47
0.10825	6.92	0.119	4.11	0.12975	4.11	0.1405	3.47	0.15125	3.47
0.1085	7.14	0.11925	4.33	0.13	3.9	0.14075	3.47	0.1515	3.25
0.10875	6.49	0.1195	4.33	0.13025	3.9	0.141	3.47	0.15175	3.25
0.109	6.06	0.11975	4.33	0.1305	3.9	0.14125	3.25	0.152	3.68
0.10925	6.06	0.12	4.33	0.13075	3.9	0.1415	3.25	0.15225	3.9
0.1095	6.92	0.12025	4.33	0.131	3.9	0.14175	3.25	0.1525	3.68
0.10975	7.14	0.1205	4.55	0.13125	4.11	0.142	3.47	0.15275	3.68
0.11	7.35	0.12075	4.55	0.1315	4.11	0.14225	3.47	0.153	3.68
0.11025	6.92	0.121	4.76	0.13175	4.11	0.1425	3.68	0.15325	3.68
0.1105	6.71	0.12125	4.55	0.132	4.11	0.14275	3.47	0.1535	3.68
0.11075	6.06	0.1215	4.76	0.13225	3.9	0.143	3.25	0.15375	3.47
0.111	5.63	0.12175	4.55	0.1325	3.9	0.14325	3.47	0.154	3.68
0.11125	5.41	0.122	4.33	0.13275	4.11	0.1435	3.47	0.15425	3.47
0.1115	5.19	0.12225	4.55	0.133	4.11	0.14375	3.25	0.1545	2.17
0.11175	5.19	0.1225	4.33	0.13325	4.33	0.144	3.25	0.15475	2.6
0.112	5.19	0.12275	4.55	0.1335	4.33	0.14425	3.25	0.155	3.03
0.11225	5.19	0.123	4.55	0.13375	4.11	0.1445	3.25	0.15525	3.03
0.1125	5.41	0.12325	4.11	0.134	3.9	0.14475	3.47	0.1555	3.03

Gauge16_4 Time msec	Gauge16_4 Stress MPa	Gauge16_4 Time msec	Gauge16_4 Stress MPa	Gauge16_4 Time msec	Gauge16_4 Stress MPa	Gauge16_5 Time msec	Gauge16_5 Stress MPa	Gauge16_5 Time msec	Gauge16_5 Stress MPa
0.15575	3.47	0.1665	3.47	0.17725	4.98	0.07225	0.056	0.09375	0.056
0.156	3.68	0.16675	4.33	0.1775	4.98	0.07275	0.056	0.09425	0.056
0.15625	3.9	0.167	3.9	0.17775	5.19	0.07325	0.056	0.09475	0.056
0.1565	4.11	0.16725	3.47	0.178	4.98	0.07375	0	0.09525	0.056
0.15675	4.55	0.1675	3.47	0.17825	5.19	0.07425	0	0.09575	0
0.157	4.55	0.16775	3.25	0.1785	5.19	0.07475	0.112	0.09625	0.056
0.15725	4.33	0.168	2.6	0.17875	5.19	0.07525	0	0.09675	0
0.1575	4.55	0.16825	3.03	0.179	4.98	0.07575	0.056	0.09725	-0.056
0.15775	3.9	0.1685	2.82	0.17925	4.98	0.07625	0.056	0.09775	-0.056
0.158	3.68	0.16875	2.82	0.1795	4.33	0.07675	0.056	0.09825	0
0.15825	3.47	0.169	3.25	0.17975	4.33	0.07725	0.056	0.09875	0.056
0.1585	3.47	0.16925	3.68	0.18	4.11	0.07775	0.056	0.09925	0.056
0.15875	3.25	0.1695	3.47	0.18025	4.33	0.07825	0	0.09975	0.056
0.159	3.25	0.16975	3.25	0.1805	4.33	0.07875	0	0.10025	0.112
0.15925	3.47	0.17	3.25	0.18075	4.11	0.07925	0	0.10075	0.112
0.1595	3.25	0.17025	3.47	0.181	3.9	0.07975	0	0.10125	0.167
0.15975	3.25	0.1705	3.68	0.18125	3.9	0.08025	0	0.10175	0.056
0.16	3.03	0.17075	3.9	0.1815	3.68	0.08075	0	0.10225	0.112
0.16025	3.47	0.171	3.9	0.18175	3.68	0.08125	0.112	0.10275	0.167
0.1605	3.47	0.17125	3.9	0.182	3.47	0.08175	0	0.10325	0.167
0.16075	3.47	0.1715	3.9	0.18225	3.25	0.08225	-0.056	0.10375	0.223
0.161	3.25	0.17175	3.9	0.1825	3.25	0.08275	-0.112	0.10425	0.279
0.16125	3.25	0.172	3.9	0.18275	3.03	0.08325	-0.056	0.10475	0.279
0.1615	3.47	0.17225	3.9	0.183	3.25	0.08375	-0.056	0.10525	0.279
0.16175	3.47	0.1725	4.11	0.18325	3.25	0.08425	-0.056	0.10575	0.335
0.162	3.25	0.17275	4.11	0.1835	3.25	0.08475	-0.056	0.10625	0.335
0.16225	3.03	0.173	3.9	0.18375	3.03	0.08525	-0.056	0.10675	0.39
0.1625	3.03	0.17325	3.9	0.184	3.03	0.08575	-0.056	0.10725	0.279
0.16275	3.03	0.1735	4.11	0.18425	3.03	0.08625	-0.056	0.10775	0.335
0.163	3.25	0.17375	4.11	0.1845	2.6	0.08675	0	0.10825	0.335
0.16325	3.25	0.174	4.76			0.08725	-0.112	0.10875	0.335
0.1635	3.03	0.17425	4.98			0.08775	0	0.10925	0.39
0.16375	3.03	0.1745	4.76			0.08825	0	0.10975	0.39
0.164	3.03	0.17475	4.98			0.08875	0	0.11025	0.446
0.16425	3.03	0.175	5.41			0.08925	0.056	0.11075	0.502
0.1645	3.25	0.17525	5.19			0.08975	0.056	0.11125	0.725
0.16475	3.25	0.1755	5.19			0.09025	0.056	0.11175	0.892
0.165	3.25	0.17575	4.98			0.09075	0.056	0.11225	1.06
0.16525	3.25	0.176	4.76			0.09125	0	0.11275	1.62
0.1655	3.25	0.17625	4.76			0.09175	0.056	0.11325	2.73
0.16575	3.25	0.1765	4.76			0.09225	0.112	0.11375	4.29
0.166	3.03	0.17675	4.55			0.09275	0.056	0.11425	4.68
0.16625	3.25	0.177	4.76			0.09325	0.056	0.11475	4.12

Gauge16_5 Time msec	Gauge16_5 Stress MPa	Gauge16_5 Time msec	Gauge16_5 Stress MPa	Gauge16_5 Time msec	Gauge16_5 Stress MPa	Gauge16_5 Time msec	Gauge16_5 Stress MPa	Gauge16_6 Time msec	Gauge16_6 Stress MPa
0.11525	4.23	0.13675	4.18	0.15825	4.51	0.17975	5.07	0.1385	0.022
0.11575	4.29	0.13725	4.23	0.15875	4.62	0.18025	5.29	0.13875	0.022
0.11625	4.62	0.13775	4.29	0.15925	4.51	0.18075	5.46	0.139	0.022
0.11675	5.18	0.13825	4.34	0.15975	4.51	0.18125	5.51	0.13925	0.077
0.11725	5.46	0.13875	4.34	0.16025	4.46	0.18175	5.51	0.1395	0.022
0.11775	5.29	0.13925	4.46	0.16075	4.57	0.18225	5.68	0.13975	0.022
0.11825	5.74	0.13975	4.51	0.16125	4.68	0.18275	5.96	0.14	0.022
0.11875	6.12	0.14025	4.57	0.16175	4.62	0.18325	5.96	0.14025	0.077
0.11925	5.85	0.14075	4.68	0.16225	4.79	0.18375	5.96	0.1405	0.022
0.11975	5.51	0.14125	4.62	0.16275	5.07	0.18425	5.9	0.14075	0.077
0.12025	5.57	0.14175	4.57	0.16325	4.96	0.18475	5.85	0.141	0.022
0.12075	5.4	0.14225	4.62	0.16375	4.85	0.18525	5.68	0.14125	0.022
0.12125	5.68	0.14275	4.79	0.16425	4.68	0.18575	5.51	0.1415	0.022
0.12175	5.74	0.14325	4.68	0.16475	4.9	0.18625	5.4	0.14175	0.022
0.12225	5.57	0.14375	4.79	0.16525	4.73	0.18675	5.46	0.142	-0.033
0.12275	5.23	0.14425	4.62	0.16575	4.79			0.14225	-0.033
0.12325	5.18	0.14475	4.51	0.16625	4.73			0.1425	-0.033
0.12375	5.07	0.14525	4.51	0.16675	4.73			0.14275	0.022
0.12425	4.96	0.14575	4.4	0.16725	4.96			0.143	-0.033
0.12475	4.79	0.14625	4.29	0.16775	4.96			0.14325	-0.033
0.12525	4.68	0.14675	4.34	0.16825	4.9			0.1435	-0.033
0.12575	4.62	0.14725	4.34	0.16875	4.79			0.14375	-0.033
0.12625	4.73	0.14775	4.34	0.16925	4.9			0.144	0.022
0.12675	4.62	0.14825	4.46	0.16975	4.96			0.14425	0.022
0.12725	4.51	0.14875	4.4	0.17025	4.85			0.1445	0.077
0.12775	4.51	0.14925	4.29	0.17075	4.85			0.14475	0.077
0.12825	4.4	0.14975	4.18	0.17125	4.9			0.145	0.022
0.12875	4.4	0.15025	4.23	0.17175	4.96			0.14525	0.022
0.12925	4.29	0.15075	4.23	0.17225	4.96			0.1455	0.022
0.12975	4.23	0.15125	4.23	0.17275	4.96			0.14575	0.022
0.13025	4.07	0.15175	4.29	0.17325	4.96			0.146	0.022
0.13075	4.01	0.15225	4.34	0.17375	4.85			0.14625	0.077
0.13125	4.12	0.15275	4.51	0.17425	4.73			0.1465	0.077
0.13175	4.12	0.15325	4.46	0.17475	4.79			0.14675	0.077
0.13225	3.96	0.15375	4.51	0.17525	4.62			0.147	0.022
0.13275	3.9	0.15425	4.57	0.17575	4.62			0.14725	0.077
0.13325	4.01	0.15475	4.62	0.17625	4.68			0.1475	0.022
0.13375	3.96	0.15525	4.68	0.17675	4.73			0.14775	0.022
0.13425	4.01	0.15575	4.57	0.17725	4.79			0.148	0.022
0.13475	4.01	0.15625	4.51	0.17775	4.9			0.14825	0.077
0.13525	4.07	0.15675	4.46	0.17825	4.9			0.1485	0.077
0.13575	4.07	0.15725	4.4	0.17875	5.01			0.14875	0.022
0.13625	4.01	0.15775	4.4	0.17925	5.12			0.149	-0.033

Gauge16_6 Time msec	Gauge16_6 Stress MPa	Gauge16_6 Time msec	Gauge16_6 Stress MPa	Gauge16_6 Time msec	Gauge16_6 Stress MPa	Gauge16_6 Time msec	Gauge16_6 Stress MPa	Gauge16_6 Time msec	Gauge16_6 Stress MPa
0.14925	0.022	0.16	-0.033	0.17075	2.33	0.1815	4.25	0.19225	4.25
0.1495	0.022	0.16025	-0.033	0.171	2.77	0.18175	4.3	0.1925	4.3
0.14975	0.077	0.1605	-0.033	0.17125	3.26	0.182	4.41	0.19275	4.25
0.15	0.022	0.16075	0.022	0.1715	3.75	0.18225	4.52	0.193	4.14
0.15025	0.022	0.161	0.022	0.17175	4.03	0.1825	4.68	0.19325	4.19
0.1505	0.022	0.16125	0.022	0.172	4.25	0.18275	4.85	0.1935	4.14
0.15075	-0.033	0.1615	0.077	0.17225	4.46	0.183	4.9	0.19375	4.03
0.151	0.022	0.16175	0.077	0.1725	4.96	0.18325	4.9	0.194	4.08
0.15125	0.022	0.162	0.077	0.17275	5.34	0.1835	4.79	0.19425	4.08
0.1515	0.022	0.16225	0.022	0.173	5.67	0.18375	4.57	0.1945	4.03
0.15175	0.022	0.1625	0.022	0.17325	5.83	0.184	4.52	0.19475	3.97
0.152	0.022	0.16275	0.022	0.1735	5.89	0.18425	4.52	0.195	3.97
0.15225	0.022	0.163	0.022	0.17375	5.78	0.1845	4.52	0.19525	3.97
0.1525	0.077	0.16325	0.077	0.174	5.72	0.18475	4.52	0.1955	3.86
0.15275	0.022	0.1635	0.077	0.17425	5.61	0.185	4.52	0.19575	3.86
0.153	0.077	0.16375	0.077	0.1745	5.56	0.18525	4.57	0.196	3.97
0.15325	0.077	0.164	0.022	0.17475	5.61	0.1855	4.52	0.19625	3.97
0.1535	0.077	0.16425	0.022	0.175	5.45	0.18575	4.46	0.1965	3.92
0.15375	0.022	0.1645	0.022	0.17525	5.4	0.186	4.52	0.19675	3.86
0.154	0.077	0.16475	0.022	0.1755	5.34	0.18625	4.52	0.197	3.81
0.15425	0.077	0.165	0.077	0.17575	5.23	0.1865	4.57	0.19725	3.86
0.1545	0.132	0.16525	0.077	0.176	5.18	0.18675	4.57	0.1975	3.97
0.15475	0.077	0.1655	0.077	0.17625	5.12	0.187	4.52	0.19775	3.97
0.155	0.022	0.16575	0.132	0.1765	5.07	0.18725	4.46	0.198	3.86
0.15525	0.077	0.166	0.132	0.17675	4.96	0.1875	4.52	0.19825	4.03
0.1555	0.022	0.16625	0.132	0.177	4.85	0.18775	4.52	0.1985	4.25
0.15575	0.077	0.1665	0.187	0.17725	4.68	0.188	4.52	0.19875	4.25
0.156	0.077	0.16675	0.242	0.1775	4.57	0.18825	4.57	0.199	4.14
0.15625	0.077	0.167	0.351	0.17775	4.41	0.1885	4.57	0.19925	3.97
0.1565	0.022	0.16725	0.461	0.178	4.3	0.18875	4.57	0.1995	3.92
0.15675	0.022	0.1675	0.681	0.17825	4.3	0.189	4.57	0.19975	4.03
0.157	0.022	0.16775	1.01	0.1785	4.3	0.18925	4.52	0.2	3.97
0.15725	0.022	0.168	1.45	0.17875	4.36	0.1895	4.52	0.20025	4.08
0.1575	0.077	0.16825	1.94	0.179	4.36	0.18975	4.46	0.2005	4.3
0.15775	0.077	0.1685	2.44	0.17925	4.41	0.19	4.3	0.20075	4.36
0.158	0.077	0.16875	2.82	0.1795	4.3	0.19025	4.36	0.201	4.03
0.15825	0.022	0.169	3.26	0.17975	4.25	0.1905	4.36	0.20125	3.92
0.1585	-0.033	0.16925	3.31	0.18	4.14	0.19075	4.3	0.2015	3.75
0.15875	0.022	0.1695	3.2	0.18025	4.14	0.191	4.36	0.20175	3.75
0.159	-0.033	0.16975	2.88	0.1805	4.14	0.19125	4.41	0.202	3.81
0.15925	-0.033	0.17	2.38	0.18075	4.14	0.1915	4.36	0.20225	3.92
0.1595	0.022	0.17025	1.94	0.181	4.19	0.19175	4.19	0.2025	3.97
0.15975	0.022	0.1705	1.94	0.18125	4.25	0.192	4.19	0.20275	3.92

Gauge16_6 Time msec	Gauge16_6 Stress MPa	Gauge16_6 Time msec	Gauge16_6 Stress MPa	Gauge16_6 Time msec	Gauge16_6 Stress MPa	Gauge16_6 Time msec	Gauge16_6 Stress MPa	Gauge16_6 Time msec	Gauge16_6 Stress MPa
0.203	3.81	0.21375	3.26	0.2245	4.08	0.23525	2.88	0.246	2.93
0.20325	3.75	0.214	3.31	0.22475	3.7	0.2355	3.04	0.24625	3.31
0.2035	3.86	0.21425	2.88	0.225	3.04	0.23575	2.99	0.2465	2.82
0.20375	3.92	0.2145	2.99	0.22525	3.26	0.236	3.04	0.24675	2.93
0.204	4.19	0.21475	2.99	0.2255	3.15	0.23625	2.99	0.247	2.99
0.20425	4.19	0.215	3.2	0.22575	3.15	0.2365	2.82	0.24725	3.04
0.2045	4.08	0.21525	3.42	0.226	3.15	0.23675	2.99	0.2475	2.71
0.20475	4.08	0.2155	3.64	0.22625	3.2	0.237	2.93	0.24775	3.86
0.205	4.03	0.21575	3.64	0.2265	2.66	0.23725	2.71	0.248	4.03
0.20525	4.03	0.216	3.59	0.22675	2.71	0.2375	2.88	0.24825	2.88
0.2055	3.81	0.21625	3.92	0.227	2.99	0.23775	2.99	0.2485	2.38
0.20575	3.75	0.2165	3.86	0.22725	2.88	0.238	2.88	0.24875	1.78
0.206	3.86	0.21675	3.92	0.2275	2.77	0.23825	2.82	0.249	2.16
0.20625	3.97	0.217	4.14	0.22775	2.6	0.2385	2.55	0.24925	2.22
0.2065	4.08	0.21725	3.81	0.228	2.71	0.23875	2.71	0.2495	3.15
0.20675	4.14	0.2175	3.81	0.22825	2.66	0.239	2.71	0.24975	2.49
0.207	4.14	0.21775	4.03	0.2285	2.77	0.23925	2.82	0.25	2
0.20725	4.14	0.218	3.81	0.22875	3.04	0.2395	2.82	0.25025	1.61
0.2075	4.08	0.21825	3.81	0.229	2.99	0.23975	2.93	0.2505	1.94
0.20775	3.81	0.2185	3.97	0.22925	3.2	0.24	3.15	0.25075	2
0.208	3.7	0.21875	4.03	0.2295	3.64	0.24025	3.37	0.251	2.22
0.20825	3.81	0.219	4.79	0.22975	3.04	0.2405	3.15	0.25125	2.11
0.2085	3.75	0.21925	4.03	0.23	3.15	0.24075	2.93	0.2515	2.11
0.20875	3.75	0.2195	3.42	0.23025	3.59	0.241	2.93	0.25175	2.22
0.209	3.81	0.21975	3.53	0.2305	3.75	0.24125	2.88	0.252	1.83
0.20925	3.97	0.22	3.15	0.23075	3.37	0.2415	2.71	0.25225	1.83
0.2095	4.19	0.22025	3.37	0.231	3.42	0.24175	2.93	0.2525	2.16
0.20975	3.92	0.2205	2.82	0.23125	3.53	0.242	2.99	0.25275	2.77
0.21	3.75	0.22075	3.09	0.2315	3.92	0.24225	2.6	0.253	2.27
0.21025	3.81	0.221	2.82	0.23175	4.08	0.2425	2.71	0.25325	2.11
0.2105	3.81	0.22125	2.49	0.232	3.81	0.24275	2.77	0.2535	2
0.21075	3.92	0.2215	2.88	0.23225	3.59	0.243	2.6	0.25375	1.94
0.211	3.97	0.22175	3.15	0.2325	3.7	0.24325	2.44	0.254	1.39
0.21125	3.97	0.222	3.37	0.23275	3.75	0.2435	1.89	0.25425	1.45
0.2115	3.92	0.22225	3.48	0.233	3.7	0.24375	2.16	0.2545	0.242
0.21175	3.92	0.2225	3.42	0.23325	3.26	0.244	2.44	0.25475	1.39
0.212	3.81	0.22275	3.2	0.2335	3.04	0.24425	2.6	0.255	2.16
0.21225	3.81	0.223	3.09	0.23375	3.15	0.2445	2.16	0.25525	1.83
0.2125	3.75	0.22325	3.53	0.234	3.09	0.24475	2.55	0.2555	1.94
0.21275	3.75	0.2235	3.75	0.23425	3.04	0.245	2.6	0.25575	2.05
0.213	3.31	0.22375	4.36	0.2345	2.6	0.24525	2.33	0.256	2.16
0.21325	3.15	0.224	4.36	0.23475	2.33	0.2455	2.49	0.25625	0.626
0.2135	3.26	0.22425	4.3	0.235	2.44	0.24575	2.71	0.2565	1.17



Gauge 16_6 Time msec	Gauge 16_6 Stress MPa	Gauge 16_6 Time msec	Gauge 16_6 Stress MPa
0.25675	1.83	0.2675	-0.363
0.257	1.89	0.26775	-0.143
0.25725	2	0.268	-0.088
0.2575	2	0.26825	-0.143
0.25775	2	0.2685	-0.143
0.258	1.94	0.26875	-0.033
0.25825	2.05	0.269	0.242
0.2585	1.78	0.26925	0.242
0.25875	1.56	0.2695	-0.198
0.259	1.56	0.26975	-0.088
0.25925	1.72	0.27	0.461
0.2595	1.83	0.27025	0.791
0.25975	1.56	0.2705	1.23
0.26	1.5	0.27075	0.351
0.26025	1.45	0.271	1.61
0.2605	1.67	0.27125	2.38
0.26075	1.72	0.2715	1.94
0.261	1.78	0.27175	0.406
0.26125	6.11	0.272	0.132
0.2615	7.64	0.27225	-0.143
0.26175	7.64	0.2725	-0.088
0.262	5.94	0.27275	2.6
0.26225	4.63	0.273	1.83
0.2625	4.3	0.27325	0.681
0.26275	3.97	0.2735	0.571
0.263	3.42	0.27375	3.37
0.26325	2.82	0.274	5.01
0.2635	2.44	0.27425	1.67
0.26375	1.78	0.2745	1.12
0.264	1.5	0.27475	2.16
0.26425	1.28	0.275	1.78
0.2645	0.955	0.27525	0.077
0.26475	0.955	0.2755	-0.637
0.265	0.736	0.27575	-0.692
0.26525	0.516	0.276	-0.143
0.2655	0.297	0.27625	0.846
0.26575	0.022	0.2765	1.94
0.266	-0.143	0.27675	0.297
0.26625	-0.033	0.277	1.67
0.2665	0.077	0.27725	0.791
0.26675	0.022		
0.267	-0.198		
0.26725	-0.308		

Gauge 17_1 Time msec	Gauge 17_1 Stress MPa	Gauge 17_1 Time msec	Gauge 17_1 Stress MPa	Gauge 17_1 Time msec	Gauge 17_1 Stress MPa	Gauge 17_1 Time msec	Gauge 17_1 Stress MPa	Gauge 17_1 Time msec	Gauge 17_1 Stress MPa
-0.02725	84.57	-0.0165	28.47	-0.00575	0	0.005	112.19	0.01575	-87.13
-0.027	56.66	-0.01625	0	-0.0055	0	0.00525	112.19	0.016	-87.13
-0.02675	56.66	-0.016	28.47	-0.00525	28.47	0.0055	84.57	0.01625	-87.13
-0.0265	56.66	-0.01575	28.47	-0.005	0	0.00575	84.57	0.0165	-116.75
-0.02625	28.47	-0.0155	28.47	-0.00475	28.47	0.006	56.66	0.01675	-116.75
-0.026	28.47	-0.01525	0	-0.0045	0	0.00625	28.47	0.017	-146.65
-0.02575	56.66	-0.015	28.47	-0.00425	0	0.0065	0	0.01725	-116.75
-0.0255	28.47	-0.01475	0	-0.004	0	0.00675	0	0.0175	-207.3
-0.02525	28.47	-0.0145	28.47	-0.00375	0	0.007	-28.76	0.01775	-176.83
-0.025	56.66	-0.01425	0	-0.0035	-28.76	0.00725	-28.76	0.018	-176.83
-0.02475	56.66	-0.014	28.47	-0.00325	0	0.0075	-28.76	0.01825	-207.3
-0.0245	56.66	-0.01375	0	-0.003	0	0.00775	0	0.0185	-207.3
-0.02425	56.66	-0.0135	0	-0.00275	0	0.008	0	0.01875	-238.05
-0.024	28.47	-0.01325	0	-0.0025	0	0.00825	0	0.019	-238.05
-0.02375	28.47	-0.013	28.47	-0.00225	0	0.0085	0	0.01925	-304.94
-0.0235	28.47	-0.01275	0	-0.002	-28.76	0.00875	0	0.0195	-337.61
-0.02325	28.47	-0.0125	0	-0.00175	-28.76	0.009	28.47	0.01975	-373.16
-0.023	28.47	-0.01225	0	-0.0015	28.47	0.00925	56.66	0.02	-411.67
-0.02275	28.47	-0.012	0	-0.00125	-28.76	0.0095	84.57	0.02025	-453.21
-0.0225	28.47	-0.01175	0	-0.001	0	0.00975	84.57	0.0205	-497.84
-0.02225	28.47	-0.0115	0	-0.00075	0	0.01	84.57	0.027	-411.67
-0.022	28.47	-0.01125	0	-0.0005	0	0.01025	84.57	0.02725	-411.67
-0.02175	28.47	-0.011	28.47	-0.00025	0	0.0105	56.66	0.0275	-411.67
-0.0215	28.47	-0.01075	0	0	28.47	0.01075	56.66	0.028	-411.67
-0.02125	28.47	-0.0105	0	0.00025	84.57	0.011	56.66	0.02825	-337.61
-0.021	56.66	-0.01025	0	0.0005	219.82	0.01125	56.66	0.0285	-337.61
-0.02075	28.47	-0.01	0	0.00075	487.78	0.0115	0	0.02875	-304.94
-0.0205	28.47	-0.00975	28.47	0.001	787.94	0.01175	0	0.029	-238.05
-0.02025	28.47	-0.0095	28.47	0.00125	999.94	0.012	28.47	0.02925	-207.3
-0.02	28.47	-0.00925	0	0.0015	1043.92	0.01225	-28.76	0.0295	-238.05
-0.01975	28.47	-0.009	0	0.00175	1088.32	0.0125	0	0.02975	-238.05
-0.0195	56.66	-0.00875	28.47	0.002	1043.92	0.01275	-28.76	0.03	-207.3
-0.01925	28.47	-0.0085	0	0.00225	999.94	0.013	-87.13	0.03025	-207.3
-0.019	28.47	-0.00825	28.47	0.0025	913.42	0.01325	0.012	0.0305	-176.83
-0.01875	28.47	-0.008	0	0.00275	829.13	0.0135	-87.13	0.03075	-176.83
-0.0185	28.47	-0.00775	28.47	0.003	747.45	0.01375	-87.13	0.031	-146.65
-0.01825	28.47	-0.0075	0	0.00325	630.66	0.014	-87.13	0.03125	-116.75
-0.018	28.47	-0.00725	0	0.0035	487.78	0.01425	-57.8	0.0315	-116.75
-0.01775	28.47	-0.007	0	0.00375	422.77	0.0145	0	0.03175	-116.75
-0.0175	28.47	-0.00675	0	0.004	334.52	0.01475	-28.76	0.032	-116.75
-0.01725	28.47	-0.0065	28.47	0.00425	219.82	0.015	-28.76	0.03225	-116.75
-0.017	28.47	-0.00625	0	0.0045	139.52	0.01525	-87.13	0.0325	-116.75
-0.01675	56.66	-0.006	0	0.00475	139.52	0.0155	-87.13	0.03275	-116.75

Gauge17_1 Time msec	Gauge17_1 Stress MPa	Gauge17_1 Time msec	Gauge17_1 Stress MPa	Gauge17_2 Time msec	Gauge17_2 Stress MPa	Gauge17_2 Time msec	Gauge17_2 Stress MPa	Gauge17_3 Time msec	Gauge17_3 Stress MPa
0.033	-116.75	0.04375	-238.05	0.03275	0.356	0.05425	0	0.03775	0.354
0.03325	-116.75	0.044	-238.05	0.03325	0.713	0.05475	0	0.038	0.354
0.0335	-116.75	0.04425	-238.05	0.03375	0.356	0.05525	0	0.03825	0.354
0.03375	-146.65	0.0445	-207.3	0.03425	0.356	0.05575	0	0.0385	0.354
0.034	-146.65	0.04475	-238.05	0.03475	0.356	0.05625	0	0.03875	0.354
0.03425	-176.83	0.045	-207.3	0.03525	0.356	0.05675	0	0.039	0.354
0.0345	-146.65	0.04525	-207.3	0.03575	0.356	0.05725	0.356	0.03925	0.354
0.03475	-146.65	0.0455	-238.05	0.03625	0.356	0.05775	0.356	0.0395	0.354
0.035	-146.65	0.04575	-207.3	0.03675	0.356	0.05825	0.356	0.03975	0.354
0.03525	-146.65	0.046	-207.3	0.03725	0.356	0.05875	0	0.04	0.354
0.0355	-146.65	0.04625	-207.3	0.03775	0.356	0.05925	0	0.04025	0.354
0.03575	-146.65	0.0465	-207.3	0.03825	0.356	0.05975	0.356	0.0405	0
0.036	-146.65	0.04675	-207.3	0.03875	0.356	0.06025	0	0.04075	0.354
0.03625	-146.65	0.047	-207.3	0.03925	0.356	0.06075	0	0.041	0
0.0365	-176.83	0.04725	-238.05	0.03975	0.356	0.06125	0	0.04125	0.354
0.03675	-146.65	0.0475	-453.21	0.04025	0.356	0.06175	-0.356	0.0415	0.354
0.037	-146.65	0.04775	-411.67	0.04075	0.356	0.06225	0	0.04175	0.354
0.03725	-146.65	0.048	-337.61	0.04125	0.356	0.06275	0	0.042	0.354
0.0375	-146.65	0.04825	-373.16	0.04175	0.356	0.06325	-0.356	0.04225	0.354
0.03775	-146.65	0.0485	-411.67	0.04225	0.356	0.06375	-0.356	0.0425	0.354
0.038	-146.65	0.04875	-453.21	0.04275	0.356	0.06425	1.07	0.04275	0.354
0.03825	-146.65	0.049	-453.21	0.04325	0.356	0.06475	6.05	0.043	0.354
0.0385	-146.65	0.04925	-497.84	0.04375	0.356	0.06525	12.8	0.04325	0.354
0.03875	-146.65			0.04425	0.713	0.06575	13.16	0.0435	0.354
0.039	-176.83			0.04475	0.356	0.06625	12.45	0.04375	0
0.03925	-176.83			0.04525	0.356	0.06675	9.25	0.044	0
0.0395	-176.83			0.04575	0.356	0.06725	8.19	0.04425	0.354
0.03975	-176.83			0.04625	0.356	0.06775	8.9	0.0445	0
0.04	-176.83			0.04675	0.356	0.06825	-1.43	0.04475	0.354
0.04025	-207.3			0.04725	0.356			0.045	0.354
0.0405	-207.3			0.04775	0.356			0.04525	0.354
0.04075	-238.05			0.04825	0			0.0455	0
0.041	-497.84			0.04875	0			0.04575	0
0.04125	-238.05			0.04925	0.356			0.046	0
0.0415	-238.05			0.04975	0			0.04625	0
0.04175	-207.3			0.05025	0.356			0.0465	0.354
0.042	-207.3			0.05075	0			0.04675	0
0.04225	-238.05			0.05125	-0.356			0.047	0
0.0425	-207.3			0.05175	0.356			0.04725	0.354
0.04275	-207.3			0.05225	0			0.0475	0
0.043	-238.05			0.05275	0			0.04775	0
0.04325	-207.3			0.05325	0			0.048	0.354
0.0435	-207.3			0.05375	0			0.04825	0

Gauge17_3 Time msec	Gauge17_3 Stress MPa	Gauge17_3 Time msec	Gauge17_3 Stress MPa	Gauge17_3 Time msec	Gauge17_3 Stress MPa	Gauge17_3 Time msec	Gauge17_3 Stress MPa	Gauge17_3 Time msec	Gauge17_3 Stress MPa
0.0485	0	0.05925	0.354	0.07	-3.89	0.08075	-6.37	0.0915	-7.08
0.04875	0	0.0595	0.354	0.07025	-3.54	0.081	-6.02	0.09175	-6.37
0.049	0	0.05975	0.707	0.0705	-3.89	0.08125	-5.31	0.092	-6.73
0.04925	0	0.06	1.41	0.07075	-4.25	0.0815	-4.96	0.09225	-6.37
0.0495	0	0.06025	1.77	0.071	-4.6	0.08175	-4.25	0.0925	-6.37
0.04975	0	0.0605	1.77	0.07125	-4.25	0.082	-4.6	0.09275	-5.66
0.05	0.354	0.06075	2.12	0.0715	-3.54	0.08225	-4.6	0.093	-6.37
0.05025	0	0.061	3.18	0.07175	-3.19	0.0825	-4.96	0.09325	-7.08
0.0505	0	0.06125	2.83	0.072	-3.89	0.08275	-5.31	0.0935	-7.79
0.05075	0	0.0615	5.3	0.07225	-3.54	0.083	-5.31	0.09375	-6.02
0.051	0	0.06175	6.01	0.0725	-2.48	0.08325	-6.02	0.094	-6.02
0.05125	0.354	0.062	7.07	0.07275	-1.77	0.0835	-5.66	0.09425	-6.73
0.0515	0	0.06225	7.07	0.073	-1.77	0.08375	-5.66	0.0945	-5.31
0.05175	0.354	0.0625	7.42	0.07325	-2.48	0.084	-5.31	0.09475	-4.25
0.052	0	0.06275	6.71	0.0735	-2.83	0.08425	-5.31	0.095	-5.66
0.05225	0	0.063	6.71	0.07375	-3.19	0.0845	-5.31	0.09525	-7.79
0.0525	0.354	0.06325	6.01	0.074	-2.83	0.08475	-4.96	0.0955	-11.7
0.05275	0.354	0.0635	5.3	0.07425	-3.19	0.085	-4.6	0.09575	-9.92
0.053	0.354	0.06375	5.3	0.0745	-3.89	0.08525	-5.31	0.096	-11.34
0.05325	0	0.064	5.65	0.07475	-3.89	0.0855	-5.31	0.09625	-8.5
0.0535	0.354	0.06425	5.3	0.075	-3.19	0.08575	-5.31	0.0965	-12.05
0.05375	0	0.0645	4.24	0.07525	-4.25	0.086	-4.25	0.09675	-12.41
0.054	-0.354	0.06475	2.83	0.0755	-4.25	0.08625	-3.19	0.097	-10.63
0.05425	0	0.065	1.41	0.07575	-3.89	0.0865	-3.19	0.09725	-11.7
0.0545	0	0.06525	-0.708	0.076	-3.89	0.08675	-3.89	0.0975	-13.12
0.05475	0	0.0655	-1.77	0.07625	-4.25	0.087	-3.89	0.09775	-14.54
0.055	0.354	0.06575	-2.48	0.0765	-4.25	0.08725	-3.89		
0.05525	0	0.066	-3.19	0.07675	-3.89	0.0875	-4.25		
0.0555	0.354	0.06625	-4.25	0.077	-5.66	0.08775	-4.6		
0.05575	0	0.0665	-4.6	0.07725	-7.44	0.088	-4.6		
0.056	0	0.06675	-5.66	0.0775	-8.15	0.08825	-5.31		
0.05625	0	0.067	-6.02	0.07775	-7.79	0.0885	-5.31		
0.0565	0	0.06725	-5.66	0.078	-7.08	0.08875	-5.31		
0.05675	0	0.0675	-6.02	0.07825	-6.02	0.089	-6.37		
0.057	0	0.06775	-6.02	0.0785	-5.31	0.08925	-6.73		
0.05725	0	0.068	-5.31	0.07875	-5.66	0.0895	-5.66		
0.0575	0	0.06825	-5.31	0.079	-5.31	0.08975	-4.96		
0.05775	0	0.0685	-5.66	0.07925	-5.31	0.09	-5.31		
0.058	0.354	0.06875	-6.02	0.0795	-5.66	0.09025	-6.02		
0.05825	0.354	0.069	-5.66	0.07975	-5.66	0.0905	-6.73		
0.0585	0.354	0.06925	-4.96	0.08	-5.66	0.09075	-7.79		
0.05875	0.354	0.0695	-4.25	0.08025	-6.02	0.091	-7.08		
0.059	0.354	0.06975	-3.89	0.0805	-6.37	0.09125	-7.08		

Gauge17_4 Time msec	Gauge17_4 Stress MPa	Gauge17_4 Time msec	Gauge17_4 Stress MPa	Gauge17_4 Time msec	Gauge17_4 Stress MPa	Gauge17_4 Time msec	Gauge17_4 Stress MPa	Gauge17_4 Time msec	Gauge17_4 Stress MPa
0.06025	0	0.071	-0.684	0.06175	0	0.0925	0.342	0.10325	-1.03
0.0605	0	0.07125	-1.03	0.082	0	0.09275	0.342	0.1035	-1.37
0.06075	0	0.0715	-0.684	0.08225	-0.342	0.093	0	0.10375	0
0.061	0	0.07175	-0.684	0.0825	0	0.09325	-0.342	0.104	0.342
0.06125	0	0.072	-0.342	0.08275	0	0.0935	0	0.10425	0.342
0.0615	-0.342	0.07225	-0.342	0.083	-0.342	0.09375	0	0.1045	0
0.06175	-0.342	0.0725	-0.342	0.08325	0	0.094	-0.342	0.10475	0
0.062	-0.684	0.07275	-0.342	0.0835	0	0.09425	0.342	0.105	0
0.06225	-0.342	0.073	-0.684	0.08375	-0.684	0.0945	0	0.10525	0.342
0.0625	-0.342	0.07325	-0.684	0.084	-0.342	0.09475	-0.342	0.1055	0
0.06275	-0.684	0.0735	-0.684	0.08425	0	0.095	-0.342	0.10575	0.342
0.063	-1.03	0.07375	-1.03	0.0845	0.342	0.09525	-0.342	0.106	0.342
0.06325	-0.684	0.074	-1.03	0.08475	0	0.0955	0	0.10625	0.342
0.0635	-0.684	0.07425	-0.684	0.085	0	0.09575	0	0.1065	0.342
0.06375	-1.03	0.0745	-0.684	0.08525	0	0.096	0	0.10675	0.342
0.064	-1.03	0.07475	-0.684	0.0855	0	0.09625	-0.342	0.107	0.342
0.06425	-0.342	0.075	-0.684	0.08575	0	0.0965	0	0.10725	0.342
0.0645	-0.342	0.07525	0	0.086	0	0.09675	-0.342	0.1075	0.684
0.06475	-0.684	0.0755	-0.684	0.08625	0	0.097	-0.342	0.10775	0.684
0.065	-1.03	0.07575	-0.684	0.0865	0	0.09725	0	0.108	0.342
0.06525	-0.342	0.076	-0.684	0.08675	0	0.0975	0	0.10825	0.342
0.0655	-0.684	0.07625	-0.684	0.087	0	0.09775	0	0.1085	0.342
0.06575	-1.03	0.0765	0	0.08725	0	0.098	-0.342	0.10875	0.342
0.066	-1.03	0.07675	-0.342	0.0875	0	0.09825	0.342	0.109	0.342
0.06625	-0.684	0.077	-0.342	0.08775	0	0.0985	0.342	0.10925	0.342
0.0665	-0.684	0.07725	-0.684	0.088	0	0.09875	0.342	0.1095	0.684
0.06675	-0.342	0.0775	-0.342	0.08825	0	0.099	0	0.10975	0.684
0.067	-0.684	0.07775	-0.342	0.0885	0	0.09925	0.342	0.11	0.684
0.06725	-0.684	0.078	-0.342	0.08875	0	0.0995	0	0.11025	0.684
0.0675	-0.684	0.07825	-0.342	0.089	0	0.09975	-0.342	0.1105	0.684
0.06775	-1.03	0.0785	-0.342	0.08925	0.342	0.1	-0.342	0.11075	0.684
0.068	-1.03	0.07875	-0.684	0.0895	0	0.10025	0	0.111	0.684
0.06825	-1.03	0.079	-0.342	0.08975	0	0.1005	0	0.11125	0.684
0.0685	-1.03	0.07925	0	0.09	0.342	0.10075	0.342	0.1115	0.684
0.06875	-1.03	0.0795	0	0.09025	0	0.101	0	0.11175	0.684
0.069	-1.03	0.07975	-0.342	0.0905	0	0.10125	0	0.112	0.684
0.06925	-0.684	0.08	-0.342	0.09075	0	0.1015	-0.342	0.11225	0.684
0.0695	-0.342	0.08025	-0.342	0.091	0	0.10175	0	0.1125	0.684
0.06975	-1.03	0.0805	-0.342	0.09125	0	0.102	0	0.11275	0.684
0.07	-1.03	0.08075	-0.342	0.0915	0	0.10225	0	0.113	0.684
0.07025	-0.684	0.081	0	0.09175	0	0.1025	-1.03	0.11325	0.684
0.0705	-1.03	0.08125	-0.342	0.092	-0.342	0.10275	-2.05	0.1135	0.342
0.07075	-0.342	0.0815	-0.342	0.09225	0	0.103	-0.684	0.11375	0.684

Gauge17_4 Time msec	Gauge17_4 Stress MPa	Gauge17_4 Time msec	Gauge17_4 Stress MPa	Gauge17_4 Time msec	Gauge17_4 Stress MPa	Gauge17_4 Time msec	Gauge17_4 Stress MPa	Gauge17_5 Time msec	Gauge17_5 Stress MPa
0.114	0.684	0.12475	-3.08	0.1355	-1.71	0.14625	10.24	0.05825	0.18
0.11425	0.342	0.125	-3.42	0.13575	-0.684	0.1465	10.58	0.05875	0.18
0.1145	0.684	0.12525	-3.42	0.136	-0.342	0.14675	11.26	0.05925	0
0.11475	0.684	0.1255	-3.42	0.13625	-0.342	0.147	15.01	0.05975	0
0.115	1.03	0.12575	-3.76	0.1365	-1.37	0.14725	8.88	0.06025	0.359
0.11525	1.03	0.126	-3.42	0.13675	-2.05	0.1475	1.03	0.06075	0.18
0.1155	1.03	0.12625	-3.08	0.137	-1.71	0.14775	-2.74	0.06125	-0.359
0.11575	1.37	0.1265	-3.08	0.13725	-1.37	0.148	-2.74	0.06175	0
0.116	1.03	0.12675	-3.08	0.1375	-1.03	0.14825	-2.39	0.06225	0.18
0.11625	1.37	0.127	-2.39	0.13775	-2.39	0.1485	-7.88	0.06275	0.18
0.1165	1.03	0.12725	-2.05	0.138	-3.76	0.14875	-8.22	0.06325	0.18
0.11675	1.03	0.1275	-1.71	0.13825	-4.79	0.149	-10.62	0.06375	0
0.117	1.03	0.12775	-1.71	0.1385	-5.48	0.14925	-7.19	0.06425	0.359
0.11725	1.03	0.128	-2.05	0.13875	-6.16	0.1495	-7.19	0.06475	0.18
0.1175	1.37	0.12825	-2.05	0.139	-5.48	0.14975	-6.85	0.06525	0.18
0.11775	1.37	0.1285	-2.05	0.13925	-5.48	0.15	-8.22	0.06575	0.18
0.118	1.37	0.12875	-1.71	0.1395	-5.48	0.15025	-10.62	0.06625	0.18
0.11825	1.37	0.129	-1.71	0.13975	-6.85	0.1505	-13.03	0.06675	0.539
0.1185	0.684	0.12925	-1.71	0.14	-7.53			0.06725	0.18
0.11875	1.03	0.1295	-2.05	0.14025	-7.53			0.06775	0
0.119	0.684	0.12975	-1.37	0.1405	-7.53			0.06825	0.18
0.11925	1.03	0.13	-1.37	0.14075	-8.22			0.06875	-0.18
0.1195	1.03	0.13025	-1.71	0.141	-7.19			0.06925	0
0.11975	1.37	0.1305	-2.05	0.14125	-5.13			0.06975	0
0.12	1.71	0.13075	-2.39	0.1415	-5.48			0.07025	0
0.12025	2.05	0.131	-2.39	0.14175	-4.11			0.07075	0.18
0.1205	3.08	0.13125	-2.05	0.142	-4.79			0.07125	0.18
0.12075	3.76	0.1315	-2.39	0.14225	-3.42			0.07175	-0.898
0.121	5.81	0.13175	-3.08	0.1425	-4.45			0.07225	0.18
0.12125	8.88	0.132	-2.74	0.14275	-5.48			0.07275	0.898
0.1215	10.58	0.13225	-3.42	0.143	-5.48			0.07325	-0.18
0.12175	12.28	0.1325	-3.76	0.14325	-5.48			0.07375	-0.539
0.122	11.26	0.13275	-3.42	0.1435	-5.82			0.07425	0
0.12225	8.54	0.133	-2.74	0.14375	-5.82			0.07475	0.18
0.1225	5.81	0.13325	-2.05	0.144	-5.48			0.07525	0.18
0.12275	3.76	0.1335	-1.71	0.14425	-5.13			0.07575	0
0.123	1.71	0.13375	-2.39	0.1445	-6.16			0.07625	0.18
0.12325	0.684	0.134	-2.39	0.14475	-6.16			0.07675	0.18
0.1235	-0.684	0.13425	-2.74	0.145	-5.13			0.07725	0.18
0.12375	-1.71	0.1345	-2.39	0.14525	-5.13			0.07775	0
0.124	-2.39	0.13475	-2.05	0.1455	-5.48			0.07825	0
0.12425	-2.39	0.135	-2.05	0.14575	-4.79			0.07875	-0.18
0.1245	-3.08	0.13525	-2.05	0.146	2.73			0.07925	0.18

Gauge17_5 Time msec	Gauge17_5 Stress MPa	Gauge17_5 Time msec	Gauge17_5 Stress MPa	Gauge17_5 Time msec	Gauge17_5 Stress MPa	Gauge17_6 Time msec	Gauge17_6 Stress MPa	Gauge17_6 Time msec	Gauge17_6 Stress MPa
0.07975	0	0.10125	0	0.12275	-9.89	0.12275	0	0.1335	0
0.08025	0.18	0.10175	0.18	0.12325	-11.16	0.123	0	0.13375	0
0.08075	-0.18	0.10225	-0.359	0.12375	-12.78	0.12325	0.179	0.134	0
0.08125	0.18	0.10275	0	0.12425	-12.6	0.1235	0	0.13425	0
0.08175	0	0.10325	0.18	0.12475	-13.68	0.12375	0	0.1345	-0.179
0.08225	0.18	0.10375	0			0.124	0	0.13475	-0.179
0.08275	0.18	0.10425	-0.18			0.12425	0	0.135	-0.179
0.08325	0.18	0.10475	-0.18			0.1245	0	0.13525	-0.179
0.08375	0	0.10525	0.18			0.12475	-0.179	0.1355	-0.179
0.08425	0.18	0.10575	0			0.125	-0.179	0.13575	0
0.08475	0.18	0.10625	0.18			0.12525	-0.179	0.136	-0.179
0.08525	0	0.10675	0.18			0.1255	-0.179	0.13625	0
0.08575	0	0.10725	0.18			0.12575	0	0.1365	0
0.08625	0.18	0.10775	0.18			0.126	0	0.13675	0
0.08675	0	0.10825	0.359			0.12625	0	0.137	-0.179
0.08725	0	0.10875	0			0.1265	0	0.13725	-0.179
0.08775	-0.18	0.10925	0			0.12675	0	0.1375	-0.357
0.08825	0	0.10975	0			0.127	0	0.13775	-0.536
0.08875	0	0.11025	0			0.12725	0	0.138	0
0.08925	0.18	0.11075	-0.18			0.1275	0.179	0.13825	-0.179
0.08975	-0.18	0.11125	0.18			0.12775	0.179	0.1385	-0.179
0.09025	-0.18	0.11175	0.359			0.128	0	0.13875	-0.357
0.09075	0	0.11225	0.359			0.12825	0	0.139	-0.179
0.09125	0	0.11275	0.539			0.1285	0.179	0.13925	-0.179
0.09175	-0.18	0.11325	0.18			0.12875	0	0.1395	-0.893
0.09225	-0.18	0.11375	0.18			0.129	0	0.13975	-1.07
0.09275	-0.359	0.11425	0.18			0.12925	0.18	0.14	-1.25
0.09325	-0.18	0.11475	0.359			0.1295	0	0.14025	-1.25
0.09375	-0.18	0.11525	0.539			0.12975	0	0.1405	-1.43
0.09425	0	0.11575	0.18			0.13	0	0.14075	-1.43
0.09475	-0.539	0.11625	-0.718			0.13025	0	0.141	-1.61
0.09525	-0.359	0.11675	-3.23			0.1305	0	0.14125	-1.43
0.09575	-0.18	0.11725	1.08			0.13075	0	0.1415	-2.14
0.09625	-0.359	0.11775	1.8			0.131	0.179	0.14175	-1.61
0.09675	-0.18	0.11825	0			0.13125	0	0.142	-2.5
0.09725	-0.359	0.11875	-0.359			0.1315	0	0.14225	-0.893
0.09775	-0.359	0.11925	0.359			0.13175	0	0.1425	-3.39
0.09825	-0.539	0.11975	1.26			0.132	0.179	0.14275	-1.43
0.09875	-0.18	0.12025	1.8			0.13225	0.179	0.143	-1.79
0.09925	-0.18	0.12075	0.18			0.1325	0.179	0.14325	-0.357
0.09975	-0.18	0.12125	-2.7			0.13275	0.179	0.1435	-1.25
0.10025	0	0.12175	-6.29			0.133	0.179	0.14375	-1.25
0.10075	0	0.12225	-8.09			0.13325	0	0.144	-0.718

Gauge17_6 Time msec	Gauge17_6 Stress MPa	Gauge17_6 Time msec	Gauge17_6 Stress MPa	Gauge17_6 Time msec	Gauge17_6 Stress MPa	Gauge17_6 Time msec	Gauge17_6 Stress MPa	Gauge17_6 Time msec	Gauge17_6 Stress MPa	Gauge17_6 Time msec	Gauge17_6 Stress MPa
0.14425	-0.714	0.155	-2.68	0.16575	-1.96	0.1765	-0.893	0.18725	-0.536	0.198	0.179
0.1445	-1.25	0.15525	-2.68	0.166	-1.96	0.17675	-0.893	0.1875	-0.179	0.19825	0.179
0.14475	-1.61	0.1555	-3.04	0.16625	-1.96	0.177	-0.714	0.18775	-0.357	0.1985	0
0.145	-1.61	0.15575	-2.5	0.1665	-1.79	0.17725	-1.07	0.188	-0.536	0.19875	0.179
0.14525	-1.07	0.156	-2.68	0.16675	-1.61	0.1775	-0.714	0.18825	-0.179	0.199	0.179
0.1455	-1.96	0.15625	-2.32	0.167	-1.79	0.17775	-0.893	0.1885	-0.357	0.19925	0.357
0.14575	-1.43	0.1565	-2.5	0.16725	-1.79	0.178	-0.893	0.18875	-0.179	0.1995	0.179
0.146	-1.07	0.15675	-2.32	0.1675	-1.79	0.17825	-0.893	0.189	-0.179	0.19975	0.179
0.14625	-0.893	0.157	-2.5	0.16775	-1.79	0.1785	-0.893	0.18925	-0.179	0.2	0.179
0.1465	-0.714	0.15725	-2.14	0.168	-1.61	0.17875	-0.893	0.1895	-0.357	0.20025	0.179
0.14675	-1.25	0.1575	-2.32	0.16825	-1.43	0.179	-1.07	0.18975	-0.179	0.2005	0.179
0.147	-0.893	0.15775	-2.32	0.1685	-1.25	0.17925	-0.893	0.19	-0.179	0.20075	0.357
0.14725	-1.07	0.158	-2.32	0.16875	-1.25	0.1795	-1.07	0.19025	-0.179	0.201	0.357
0.1475	-0.714	0.15825	-2.32	0.169	-1.25	0.17975	-0.893	0.1905	0	0.20125	0.357
0.14775	-1.25	0.1585	-2.68	0.16925	-1.25	0.18	-0.714	0.19075	-0.179	0.2015	0.357
0.148	-1.07	0.15875	-2.5	0.1695	-1.43	0.18025	-0.536	0.191	-0.357	0.20175	0.357
0.14825	-1.07	0.159	-2.32	0.16975	-1.61	0.1805	-0.714	0.19125	-0.179	0.202	0.536
0.1485	-0.357	0.15925	-2.32	0.17	-1.61	0.18075	-0.536	0.1915	-0.357	0.20225	0.714
0.14875	-0.714	0.1595	-2.32	0.17025	-1.43	0.181	-0.714	0.19175	0	0.2025	0.714
0.149	-1.43	0.15975	-2.5	0.1705	-1.43	0.18125	-0.536	0.192	-0.536	0.20275	0.893
0.14925	-1.07	0.16	-2.32	0.17075	-1.25	0.1815	-0.714	0.19225	0.357	0.203	1.07
0.1495	-1.43	0.16025	-2.32	0.171	-1.25	0.18175	-0.536	0.1925	-0.179	0.20325	1.43
0.14975	-0.536	0.1605	-2.14	0.17125	-1.07	0.182	-0.536	0.19275	0.179	0.2035	1.61
0.15	-1.61	0.16075	-2.14	0.1715	-1.25	0.18225	-0.357	0.193	-0.179	0.20375	2.32
0.15025	-1.07	0.161	-2.32	0.17175	-1.61	0.1825	-0.357	0.19325	-0.179	0.204	3.03
0.1505	-1.96	0.16125	-2.14	0.172	-1.61	0.18275	-0.536	0.1935	0	0.20425	3.39
0.15075	-0.536	0.1615	-2.14	0.17225	-1.61	0.183	-0.536	0.19375	-0.357	0.2045	4.1
0.151	-1.96	0.16175	-2.32	0.1725	-1.43	0.18325	-0.357	0.194	0.357	0.20475	4.28
0.15125	-1.07	0.162	-2.14	0.17275	-1.43	0.1835	-0.357	0.19425	-0.179	0.205	4.1
0.1515	-1.61	0.16225	-1.96	0.173	-1.07	0.18375	-0.536	0.1945	0.179	0.20525	4.1
0.15175	-1.07	0.1625	-1.79	0.17325	-1.07	0.184	-0.536	0.19475	0.357	0.2055	4.1
0.152	-2.14	0.16275	-1.61	0.1735	-1.07	0.18425	-0.357	0.195	0	0.20575	3.93
0.15225	-1.96	0.163	-1.61	0.17375	-1.25	0.1845	-0.357	0.19525	0.179	0.206	3.57
0.1525	-2.32	0.16325	-1.96	0.174	-1.61	0.18475	-0.714	0.1955	0	0.20625	3.03
0.15275	-2.14	0.1635	-1.96	0.17425	-1.25	0.185	-0.536	0.19575	0.179	0.2065	1.43
0.153	-2.32	0.16375	-2.14	0.1745	-1.25	0.18525	-0.536	0.196	-0.179	0.20675	-0.536
0.15325	-2.32	0.164	-2.14	0.17475	-1.25	0.1855	-0.536	0.19625	0	0.207	-1.25
0.1535	-2.14	0.16425	-1.96	0.175	-1.25	0.18575	-0.357	0.1965	0	0.20725	-3.93
0.15375	-2.5	0.1645	-1.96	0.17525	-1.07	0.186	-0.536	0.19675	0.179	0.2075	-6.08
0.154	-2.5	0.16475	-1.79	0.1755	-0.893	0.18625	-0.536	0.197	0.179	0.20775	-10.2
0.15425	-2.5	0.165	-1.79	0.17575	-0.893	0.1865	-0.536	0.19725	0.179		
0.1545	-2.68	0.16525	-1.79	0.176	-0.893	0.18675	-0.536	0.1975	0.179		
0.15475	-2.68	0.1655	-1.96	0.17625	-1.07	0.187	-0.536	0.19775	0		

Gauge18_1 Time msec	Gauge18_1 Stress MPa	Gauge18_1 Time msec	Gauge18_1 Stress MPa	Gauge18_1 Time msec	Gauge18_1 Stress MPa	Gauge18_1 Time msec	Gauge18_1 Stress MPa	Gauge18_1 Time msec	Gauge18_1 Stress MPa
-0.02725	0	-0.0165	-29.51	-0.00575	-29.51	0.005	775.3	0.01575	-59.31
-0.027	0	-0.01625	-29.51	-0.0055	-29.51	0.00525	575.97	0.016	-89.4
-0.02675	0	-0.016	-29.51	-0.00525	0	0.0055	468.63	0.01625	-59.31
-0.0265	0	-0.01575	0	-0.005	0	0.00575	372.31	0.0165	-59.31
-0.02625	0	-0.0155	-29.51	-0.00475	0	0.006	225.54	0.01675	-89.4
-0.026	0	-0.01525	0	-0.0045	0	0.00625	143.15	0.017	-89.4
-0.02575	0	-0.015	-29.51	-0.00425	0	0.0065	115.11	0.01725	-89.4
-0.0255	0	-0.01475	-29.51	-0.004	0	0.00675	143.15	0.0175	-59.31
-0.02525	0	-0.0145	0	-0.00375	0	0.007	198.37	0.01775	-150.46
-0.025	0	-0.01425	0	-0.0035	-29.51	0.00725	170.9	0.018	-89.4
-0.02475	0	-0.014	-29.51	-0.00325	0	0.0075	198.37	0.01825	-119.78
-0.0245	0	-0.01375	-29.51	-0.003	0	0.00775	115.11	0.0185	-119.78
-0.02425	0	-0.0135	-29.51	-0.00275	0	0.008	58.14	0.01875	-59.31
-0.024	0	-0.01325	-29.51	-0.0025	0	0.00825	29.21	0.019	-119.78
-0.02375	0	-0.013	0	-0.00225	0	0.0085	-89.4	0.01925	-89.4
-0.0235	0	-0.01275	-29.51	-0.002	0	0.00875	-89.4	0.0195	-119.78
-0.02325	0	-0.0125	0	-0.00175	0	0.009	29.21	0.01975	-119.78
-0.023	0	-0.01225	0	-0.0015	0	0.00925	86.77	0.02	-150.46
-0.02275	0	-0.012	0	-0.00125	0	0.0095	0	0.02025	-119.78
-0.0225	0	-0.01175	0	-0.001	0	0.00975	0	0.0205	-119.78
-0.02225	0	-0.0115	-29.51	-0.00075	29.21	0.01	-89.4	0.02075	-212.69
-0.022	0	-0.01125	-29.51	-0.0005	0	0.01025	-89.4	0.021	-119.78
-0.02175	0	-0.011	0	-0.00025	0	0.0105	-59.31	0.02125	-89.4
-0.0215	0	-0.01075	0	0	-29.51	0.01075	0	0.0215	-59.31
-0.02125	0	-0.0105	0	0.00025	0	0.011	29.21	0.02175	-59.31
-0.021	0	-0.01025	-29.51	0.0005	0	0.01125	58.14	0.022	-59.31
-0.02075	0	-0.01	-29.51	0.00075	0	0.0115	115.11	0.02225	-59.31
-0.0205	0	-0.00975	-29.51	0.001	0	0.01175	86.77	0.0225	-89.4
-0.02025	0	-0.0095	0	0.00125	-29.51	0.012	86.77	0.02275	-59.31
-0.02	0	-0.00925	0	0.0015	0	0.01225	86.77	0.023	-59.31
-0.01975	0	-0.009	0	0.00175	58.14	0.0125	86.77	0.02325	-59.31
-0.0195	0	-0.00875	-29.51	0.002	170.9	0.01275	58.14	0.0235	-89.4
-0.01925	0	-0.0085	0	0.00225	288.58	0.013	29.21	0.02375	-59.31
-0.019	0	-0.00825	0	0.0025	403.09	0.01325	29.21	0.024	-89.4
-0.01875	0	-0.008	0	0.00275	775.3	0.0135	86.77	0.02425	-59.31
-0.0185	0	-0.00775	0	0.003	1086.2	0.01375	86.77	0.0245	-59.31
-0.01825	-59.31	-0.0075	0	0.00325	1132.78	0.014	0	0.02475	-59.31
-0.018	-59.31	-0.00725	0	0.0035	1086.2	0.01425	-59.31	0.025	-89.4
-0.01775	-59.31	-0.007	0	0.00375	1086.2	0.0145	-89.4	0.02525	-89.4
-0.0175	-59.31	-0.00675	-29.51	0.004	994.42	0.01475	-59.31	0.0255	-59.31
-0.01725	-29.51	-0.0065	-29.51	0.00425	860.93	0.015	-29.51	0.02575	-59.31
-0.017	-29.51	-0.00625	29.21	0.0045	817.75	0.01525	-89.4	0.026	-89.4
-0.01675	-29.51	-0.006	0	0.00475	817.75	0.0155	-59.31	0.02625	-89.4

Gauge18_1 Time msec	Gauge18_1 Stress MPa	Gauge18_1 Time msec	Gauge18_1 Stress MPa	Gauge18_2 Time msec	Gauge18_2 Stress MPa	Gauge18_2 Time msec	Gauge18_2 Stress MPa	Gauge18_2 Time msec	Gauge18_2 Stress MPa
0.0265	-89.4	0.03725	-59.31	-0.00475	0	0.01675	0.371	0.03825	0.743
0.02675	-89.4	0.0375	-59.31	-0.00425	-0.371	0.01725	0	0.03875	0.743
0.027	-119.78	0.03775	-59.31	-0.00375	0	0.01775	1.11	0.03925	0.371
0.02725	-89.4	0.038	-59.31	-0.00325	0	0.01825	-0.371	0.03975	0.371
0.0275	-89.4	0.03825	-59.31	-0.00275	0	0.01875	-1.49	0.04025	-0.371
0.02775	-89.4	0.0385	-59.31	-0.00225	-0.371	0.01925	0.743	0.04075	0.371
0.028	-59.31	0.03875	-59.31	-0.00175	-0.371	0.01975	1.49	0.04125	0
0.02825	-59.31	0.039	-59.31	-0.00125	0.743	0.02025	-1.11	0.04175	0
0.0285	-59.31	0.03925	-59.31	-0.00075	0.371	0.02075	0.371	0.04225	10.38
0.02875	-29.51	0.0395	-59.31	-0.00025	-0.371	0.02125	-2.23	0.04275	3.71
0.029	-29.51	0.03975	-59.31	0.00025	-0.371	0.02175	0	0.04325	5.57
0.02925	-29.51	0.04	-59.31	0.00075	0	0.02225	0	0.04375	5.57
0.0295	-29.51	0.04025	-59.31	0.00125	0	0.02275	0.371	0.04425	5.94
0.02975	-29.51	0.0405	-29.51	0.00175	-0.371	0.02325	0.743	0.04475	6.31
0.03	0	0.04075	-29.51	0.00225	0	0.02375	-0.371	0.04525	9.64
0.03025	0	0.041	-29.51	0.00275	1.11	0.02425	0	0.04575	2.23
0.0305	0			0.00325	0	0.02475	0.371	0.04625	6.68
0.03075	0			0.00375	0	0.02525	0	0.04675	5.57
0.031	29.21			0.00425	0	0.02575	0	0.04725	7.79
0.03125	0			0.00475	0	0.02625	0	0.04775	7.42
0.0315	-29.51			0.00525	-0.371	0.02675	0	0.04825	7.05
0.03175	0			0.00575	-0.371	0.02725	0	0.04875	7.42
0.032	-29.51			0.00625	-0.743	0.02775	0.371	0.04925	8.16
0.03225	-29.51			0.00675	-0.371	0.02825	0.371	0.04975	8.16
0.0325	-29.51			0.00725	0	0.02875	0	0.05025	7.79
0.03275	-29.51			0.00775	0	0.02925	0	0.05075	8.53
0.033	-29.51			0.00825	1.49	0.02975	0.371	0.05125	7.79
0.03325	-29.51			0.00875	0.743	0.03025	0.371	0.05175	8.53
0.0335	-29.51			0.00925	0	0.03075	0	0.05225	8.16
0.03375	-59.31			0.00975	0.371	0.03125	0.743	0.05275	8.53
0.034	-59.31			0.01025	0.743	0.03175	0	0.05325	8.16
0.03425	-59.31			0.01075	0	0.03225	0.371	0.05375	8.9
0.0345	-29.51			0.01125	0	0.03275	0	0.05425	8.53
0.03475	-59.31			0.01175	0	0.03325	0.371	0.05475	9.27
0.035	-59.31			0.01225	0	0.03375	-0.371	0.05525	8.9
0.03525	-59.31			0.01275	0.371	0.03425	0.371	0.05575	8.9
0.0355	-59.31			0.01325	0	0.03475	0	0.05625	8.9
0.03575	-59.31			0.01375	0	0.03525	0	0.05675	8.53
0.036	-59.31			0.01425	1.49	0.03575	-0.371	0.05725	7.79
0.03625	-59.31			0.01475	0.371	0.03625	0	0.05775	8.16
0.0365	-59.31			0.01525	0.743	0.03675	0.371	0.05825	3.71
0.03675	-59.31			0.01575	0.371	0.03725	0.371	0.05875	8.53
0.037	-59.31			0.01625	0	0.03775	0	0.05925	8.9

Gauge18_2 Time msec	Gauge18_2 Stress MPa	Gauge18_2 Time msec	Gauge18_2 Stress MPa	Gauge18_2 Time msec	Gauge18_2 Stress MPa	Gauge18_2 Time msec	Gauge18_2 Stress MPa	Gauge18_2 Time msec	Gauge18_2 Stress MPa
0.05975	7.05	0.08125	3.34	0.10275	7.05	0.12425	10.01	0.14575	5.57
0.06025	7.42	0.08175	1.86	0.10325	5.94	0.12475	11.12	0.14625	22.94
0.06075	5.94	0.08225	4.08	0.10375	4.45	0.12525	10.38	0.14675	
0.06125	6.31	0.08275	5.19	0.10425	5.57	0.12575	-1.86	0.14725	19.62
0.06175	5.57	0.08325	5.94	0.10475	5.94	0.12625	8.16	0.14775	10.38
0.06225	5.19	0.08375	4.82	0.10525	6.68	0.12675	13.34	0.14825	13.71
0.06275	6.68	0.08425	3.71	0.10575	5.94	0.12725	12.97	0.14875	13.34
0.06325	12.23	0.08475	4.82	0.10625	5.19	0.12775	10.75	0.14925	14.45
0.06375	21.46	0.08525	5.57	0.10675	5.57	0.12825	12.97	0.14975	15.56
0.06425	28.46	0.08575	6.31	0.10725	5.94	0.12875	9.27	0.15025	7.42
0.06475	24.41	0.08625	5.19	0.10775	5.57	0.12925	6.68	0.15075	12.97
0.06525	15.93	0.08675	4.45	0.10825	5.57	0.12975	11.12	0.15125	7.42
0.06575	12.23	0.08725	-0.743	0.10875	5.57	0.13025	13.34	0.15175	24.41
0.06625	12.97	0.08775	7.05	0.10925	3.71	0.13075	14.45	0.15225	9.27
0.06675	12.97	0.08825	5.94	0.10975	6.31	0.13125	21.09	0.15275	13.34
0.06725	14.08	0.08875	4.08	0.11025	3.34	0.13175	17.03	0.15325	17.03
0.06775	13.71	0.08925	4.82	0.11075	-1.11	0.13225	13.71	0.15375	13.34
0.06825	13.34	0.08975	5.57	0.11125	-2.6	0.13275	8.9	0.15425	8.16
0.06875	11.12	0.09025	4.45	0.11175	1.49	0.13325	16.3	0.15475	9.27
0.06925	8.9	0.09075	5.19	0.11225	3.34	0.13375	11.12	0.15525	7.79
0.06975	7.79	0.09125	4.45	0.11275	-2.23	0.13425	12.6	0.15575	13.34
0.07025	6.68	0.09175	4.45	0.11325	-2.23	0.13475	11.12	0.15625	2.23
0.07075	6.68	0.09225	6.31	0.11375	-0.371	0.13525	12.6	0.15675	-4.09
0.07125	7.42	0.09275	3.71	0.11425	-0.743	0.13575	14.82	0.15725	4.08
0.07175	8.53	0.09325	-0.371	0.11475	-0.743	0.13625	13.34	0.15775	-2.23
0.07225	10.38	0.09375	-0.743	0.11525	0.743	0.13675	10.75	0.15825	5.57
0.07275	11.49	0.09425	4.45	0.11575	0.371	0.13725	13.34		
0.07325	12.6	0.09475	1.49	0.11625	4.08	0.13775	7.05		
0.07375	12.97	0.09525	1.49	0.11675	2.97	0.13825	12.23		
0.07425	13.34	0.09575	4.08	0.11725	4.82	0.13875	14.08		
0.07475	13.34	0.09625	4.08	0.11775	6.68	0.13925	10.38		
0.07525	12.23	0.09675	5.94	0.11825	6.68	0.13975	2.97		
0.07575	11.49	0.09725	7.05	0.11875	7.79	0.14025	11.86		
0.07625	10.38	0.09775	8.16	0.11925	7.79	0.14075	11.12		
0.07675	8.9	0.09825	6.31	0.11975	8.53	0.14125	9.64		
0.07725	8.53	0.09875	7.79	0.12025	10.01	0.14175	6.68		
0.07775	7.05	0.09925	7.42	0.12075	10.38	0.14225	10.01		
0.07825	7.05	0.09975	5.57	0.12125	10.01	0.14275	17.03		
0.07875	5.94	0.10025	7.05	0.12175	6.68	0.14325	12.97		
0.07925	3.34	0.10075	2.6	0.12225	6.68	0.14375	8.53		
0.07975	4.45	0.10125	6.31	0.12275	7.05	0.14425	18.14		
0.08025	5.94	0.10175	7.79	0.12325	7.42	0.14475	21.09		
0.08075	4.45	0.10225	7.05	0.12375	8.53	0.14525	17.03		

Gauge18_3 Time msec	Gauge18_3 Stress MPa	Gauge18_3 Time msec	Gauge18_3 Stress MPa	Gauge18_3 Time msec	Gauge18_3 Stress MPa	Gauge18_3 Time msec	Gauge18_3 Stress MPa	Gauge18_3 Time msec	Gauge18_3 Stress MPa
0.02525	0.371	0.036	0.371	0.04675	1.49	0.0575	1.11	0.06825	10.75
0.0255	0	0.03625	0.371	0.047	1.49	0.05775	1.86	0.0685	11.49
0.02575	0	0.0365	0.371	0.04725	2.23	0.058	1.11	0.06875	12.23
0.026	0	0.03675	0	0.0475	2.23	0.05825	0.743	0.069	12.97
0.02625	0	0.037	0.371	0.04775	1.49	0.0585	0	0.06925	13.34
0.0265	0	0.03725	0.743	0.048	1.49	0.05875	0.371	0.0695	13.71
0.02675	0.371	0.0375	0.371	0.04825	1.49	0.059	1.11	0.06975	12.6
0.027	0.371	0.03775	0.371	0.0485	1.86	0.05925	0.743	0.07	11.49
0.02725	0.371	0.038	0.743	0.04875	1.86	0.0595	0.371	0.07025	9.64
0.0275	0.371	0.03825	0.371	0.049	1.49	0.05975	0.743	0.0705	9.27
0.02775	0.743	0.0385	0.371	0.04925	1.49	0.06	0.743	0.07075	8.53
0.028	0.743	0.03875	0	0.0495	1.49	0.06025	0.371	0.071	8.16
0.02825	0.743	0.039	0.743	0.04975	1.86	0.0605	0.371	0.07125	8.53
0.0285	0.371	0.03925	0.743	0.05	1.86	0.06075	0.371	0.0715	9.27
0.02875	0	0.0395	0.371	0.05025	1.86	0.061	0.743	0.07175	9.27
0.029	0	0.03975	0.371	0.0505	1.86	0.06125	0.371	0.072	10.01
0.02925	0	0.04	0.371	0.05075	1.49	0.0615	0.371	0.07225	10.38
0.0295	0.371	0.04025	0.371	0.051	1.49	0.06175	0.371	0.0725	10.75
0.02975	0.371	0.0405	0.371	0.05125	1.49	0.062	0.371	0.07275	11.12
0.03	0.371	0.04075	0	0.0515	1.49	0.06225	0.371	0.073	11.49
0.03025	0	0.041	0.371	0.05175	1.49	0.0625	0.371	0.07325	11.49
0.0305	0	0.04125	0.371	0.052	1.49	0.06275	0	0.0735	11.49
0.03075	0.371	0.0415	0	0.05225	1.49	0.063	0.371	0.07375	10.38
0.031	0	0.04175	0	0.0525	1.49	0.06325	0.371	0.074	10.75
0.03125	0.371	0.042	0.743	0.05275	1.49	0.0635	0	0.07425	10.38
0.0315	0.371	0.04225	1.49	0.053	1.49	0.06375	0	0.0745	9.64
0.03175	0	0.0425	1.49	0.05325	1.49	0.064	0.371	0.07475	8.9
0.032	0.371	0.04275	1.11	0.0535	1.49	0.06425	0.371	0.075	7.79
0.03225	0.371	0.043	1.49	0.05375	1.49	0.0645	0.371	0.07525	6.68
0.0325	0.371	0.04325	1.49	0.054	1.49	0.06475	0.743	0.0755	5.94
0.03275	0.371	0.0435	1.49	0.05425	1.86	0.065	1.11	0.07575	4.08
0.033	0.371	0.04375	1.11	0.0545	1.86	0.06525	2.6	0.076	4.08
0.03325	0.371	0.044	1.49	0.05475	1.49	0.0655	4.08	0.07625	4.08
0.0335	0.371	0.04425	1.86	0.055	1.49	0.06575	5.94	0.0765	4.08
0.03375	0.371	0.0445	1.86	0.05525	1.49	0.066	7.79	0.07675	4.08
0.034	0.371	0.04475	1.86	0.0555	1.86	0.06625	9.27	0.077	3.71
0.03425	0.371	0.045	2.6	0.05575	1.49	0.0665	10.38	0.07725	3.71
0.0345	0.371	0.04525	2.97	0.056	1.49	0.06675	10.38	0.0775	3.71
0.03475	0.743	0.0455	1.49	0.05625	1.49	0.067	10.38	0.07775	3.71
0.035	0.371	0.04575	0.743	0.0565	1.49	0.06725	10.75	0.078	4.08
0.03525	0.371	0.046	1.11	0.05675	1.86	0.0675	11.49	0.07825	4.08
0.0355	0.371	0.04625	1.49	0.057	1.49	0.06775	11.12	0.0785	4.45
0.03575	0.371	0.0465	1.86	0.05725	1.11	0.068	10.75	0.07875	4.45

Gauge18_3	Gauge18_3	Gauge18_3	Gauge18_3	Gauge18_3	Gauge18_3	Gauge18_3	Gauge18_3	Gauge18_4	Gauge18_4
Time	Stress	Time	Stress	Time	Stress	Time	Stress	Time	Stress
msec	MPa	msec	MPa	msec	MPa	msec	MPa	msec	MPa
0.079	4.45	0.08975	4.45	0.1005	4.45	0.11125	-0.743	0.01775	0
0.07925	4.45	0.09	4.08	0.10075	5.57	0.1115	-0.371	0.018	0
0.0795	4.82	0.09025	4.82	0.101	5.19	0.11175	0	0.01825	0
0.07975	5.57	0.0905	4.45	0.10125	4.08	0.112	0.371	0.0185	0
0.08	6.68	0.09075	3.34	0.1015	4.08	0.11225	1.86	0.01875	0.371
0.08025	6.68	0.091	4.82	0.10175	4.08	0.1125	-0.371	0.019	0
0.0805	6.31	0.09125	4.08	0.102	3.71	0.11275	-1.11	0.01925	0.371
0.08075	5.94	0.0915	6.31	0.10225	3.71	0.113	-1.11	0.0195	0
0.081	4.45	0.09175	7.05	0.1025	3.71			0.01975	0.371
0.08125	3.34	0.092	5.19	0.10275	2.6			0.02	0
0.0815	2.6	0.09225	8.53	0.103	4.08			0.02025	-0.371
0.08175	3.34	0.0925	8.53	0.10325	3.34			0.0205	0
0.082	3.71	0.09275	10.01	0.1035	2.97			0.02075	0
0.08225	4.08	0.093	10.75	0.10375	2.23			0.021	-0.743
0.0825	3.71	0.09325	10.38	0.104	2.23			0.02125	0
0.08275	2.97	0.0935	8.9	0.10425	1.86			0.0215	0
0.083	2.97	0.09375	8.16	0.1045	1.86			0.02175	0.371
0.08325	2.97	0.094	7.42	0.10475	2.23			0.022	0
0.0835	2.97	0.09425	6.68	0.105	-0.371			0.02225	0.371
0.08375	2.6	0.0945	7.79	0.10525	-0.371			0.0225	-0.371
0.084	2.6	0.09475	7.05	0.1055	-0.371			0.02275	0
0.08425	2.97	0.095	7.05	0.10575	-5.58			0.023	0
0.0845	3.34	0.09525	6.68	0.106	-5.58			0.02325	0.371
0.08475	3.71	0.0955	7.42	0.10625	-1.11			0.0235	0.371
0.085	4.45	0.09575	7.79	0.1065	1.49			0.02375	0.371
0.08525	5.19	0.096	6.68	0.10675	1.86			0.024	0.371
0.0855	5.57	0.09625	6.68	0.107	2.97			0.02425	0
0.08575	6.68	0.0965	6.68	0.10725	2.6			0.0245	0
0.086	6.31	0.09675	6.31	0.1075	-1.11			0.02475	0
0.08625	6.31	0.097	6.31	0.10775	-1.49			0.025	0
0.0865	5.94	0.09725	6.31	0.108	-0.371			0.02525	0
0.08675	6.31	0.0975	5.57	0.10825	-0.371			0.0255	0.371
0.087	5.57	0.09775	4.82	0.1085	0.371			0.02575	0
0.08725	6.31	0.098	4.82	0.10875	0.371			0.026	0.371
0.0875	5.94	0.09825	4.82	0.109	0			0.02625	0
0.08775	5.94	0.0985	4.45	0.10925	0			0.0265	-0.371
0.088	5.57	0.09875	4.82	0.1095	0.371			0.02675	-0.371
0.08825	5.57	0.099	4.45	0.10975	0.743			0.027	0
0.0885	5.57	0.09925	4.82	0.11	0			0.02725	-0.371
0.08875	6.31	0.0995	4.45	0.11025	0.371			0.0275	0
0.089	4.82	0.09975	4.45	0.1105	0			0.02775	0
0.08925	3.71	0.1	4.82	0.11075	-0.371			0.028	0
0.0895	4.08	0.10025	4.08	0.111	-0.371			0.02825	-0.371

Gauge18_4	Gauge18_4	Gauge18_4	Gauge18_4	Gauge18_4	Gauge18_4	Gauge18_4	Gauge18_4	Gauge18_4	Gauge18_4
Time	Stress	Time	Stress	Time	Stress	Time	Stress	Time	Stress
msec	MPa	msec	MPa	msec	MPa	msec	MPa	msec	MPa
0.0285	0	0.03925	3.34	0.05	-0.743	0.06075	-0.371	0.0715	5.57
0.02875	-0.371	0.0395	2.6	0.05025	-0.743	0.061	-1.11	0.07175	4.45
0.029	0	0.03975	1.49	0.0505	-1.11	0.06125	-0.743	0.072	4.45
0.02925	-0.371	0.04	0.371	0.05075	-1.49	0.0615	-0.743	0.07225	8.9
0.0295	0	0.04025	-0.743	0.051	-1.11	0.06175	-1.11	0.0725	7.42
0.02975	0	0.0405	-1.11	0.05125	-0.743	0.062	-0.743	0.07275	5.57
0.03	0.371	0.04075	-1.11	0.0515	-0.371	0.06225	-1.11	0.073	4.45
0.03025	0.371	0.041	-0.743	0.05175	-0.743	0.0625	-0.743	0.07325	4.08
0.0305	0	0.04125	-0.371	0.052	-1.49	0.06275	-0.371	0.0735	3.34
0.03075	-0.371	0.0415	-0.371	0.05225	-1.11	0.063	-0.371	0.07375	3.34
0.031	0	0.04175	0	0.0525	-1.11	0.06325	-0.371	0.074	3.34
0.03125	0.371	0.042	0	0.05275	-1.11	0.0635	-0.743	0.07425	1.49
0.0315	0	0.04225	1.11	0.053	-1.49	0.06375	-0.743	0.0745	3.34
0.03175	-0.371	0.0425	-0.743	0.05325	-0.371	0.064	-0.743	0.07475	2.97
0.032	-0.371	0.04275	1.11	0.0535	-0.743	0.06425	-0.743	0.075	1.49
0.03225	-0.371	0.043	0	0.05375	-1.49	0.0645	-0.743	0.07525	1.11
0.0325	0	0.04325	0.371	0.054	-1.11	0.06475	-0.371	0.0755	0
0.03275	-0.371	0.0435	-1.49	0.05425	-1.11	0.065	-0.371	0.07575	0
0.033	0	0.04375	-0.743	0.0545	-0.743	0.06525	0	0.076	1.11
0.03325	0	0.044	-0.371	0.05475	-1.11	0.0655	-0.371	0.07625	0.743
0.0335	0	0.04425	0	0.055	-1.11	0.06575	-0.371	0.0765	1.49
0.03375	0	0.0445	-0.743	0.05525	-0.743	0.066	-0.743	0.07675	1.11
0.034	-0.371	0.04475	-0.371	0.0555	-0.743	0.06625	-0.371	0.077	2.23
0.03425	0.371	0.045	0	0.05575	-0.743	0.0665	-0.743	0.07725	1.86
0.0345	0.743	0.04525	1.49	0.056	-1.49	0.06675	-0.371	0.0775	0.743
0.03475	0	0.0455	-0.743	0.05625	-1.49	0.067	-0.371	0.07775	-0.743
0.035	0	0.04575	-2.23	0.0565	-1.11	0.06725	-0.371	0.078	-1.11
0.03525	-0.743	0.046	-1.49	0.05675	-0.743	0.0675	-0.371	0.07825	-0.371
0.0355	-4.46	0.04625	-0.371	0.057	-1.11	0.06775	-0.371	0.0785	0
0.03575	-3.72	0.0465	-2.23	0.05725	-0.743	0.068	-0.371	0.07875	0.371
0.036	2.97	0.04675	-0.743	0.0575	-1.86	0.06825	-0.371	0.079	0.743
0.03625	5.94	0.047	0.371	0.05775	-1.11	0.0685	-0.743	0.07925	1.11
0.0365	4.82	0.04725	1.49	0.058	-2.23	0.06875	0.371	0.0795	0.743
0.03675	1.11	0.0475	-0.743	0.05825	0.743	0.069	1.49	0.07975	0.371
0.037	-1.86	0.04775	-1.49	0.0585	-1.49	0.06925	1.11	0.08	-0.371
0.03725	-2.23	0.048	-1.49	0.05875	2.6	0.0695	1.86	0.08025	-0.743
0.0375	1.11	0.04825	-0.743	0.059	-2.97	0.06975	1.86	0.0805	-0.743
0.03775	2.23	0.0485	-1.11	0.05925	-0.743	0.07	2.23	0.08075	0.371
0.038	-2.6	0.04875	-1.86	0.0595	-2.97	0.07025	2.23	0.081	0
0.03825	-4.46	0.049	-1.11	0.05975	0.371	0.0705	2.23	0.08125	0
0.0385	-3.72	0.04925	0	0.06	-1.86	0.07075	4.08	0.0815	0
0.03875	-0.743	0.0495	0	0.06025	-0.371	0.071	5.57	0.08175	0
0.039	2.6	0.04975	-1.11	0.0605	-1.11	0.07125	5.57	0.082	0.371

Gauge18_4	Gauge18_4	Gauge18_4	Gauge18_4	Gauge18_4	Gauge18_4	Gauge18_4	Gauge18_4	Gauge18_5	Gauge18_5		
Time	Stress	Time	Stress	Time	Stress	Time	Stress	Time	Stress	Time	Stress
msec	MPa	msec	MPa	msec	MPa	msec	MPa	msec	MPa	msec	MPa
0.08225	0	0.093	-0.743	0.10375	0.743	0.1145	7.42	0.05525	-0.186		
0.0825	0	0.09325	-0.371	0.104	1.11	0.11475	7.79	0.05575	0		
0.08275	-0.371	0.0935	-0.371	0.10425	1.49	0.115	7.42	0.05625	-0.186		
0.083	-0.371	0.09375	0	0.1045	1.49	0.11525	7.05	0.05675	0		
0.08325	-0.743	0.094	0.371	0.10475	1.49	0.1155	7.05	0.05725	0		
0.0835	-0.743	0.09425	0.371	0.105	1.49	0.11575	6.31	0.05775	-0.186		
0.08375	-1.49	0.0945	0.743	0.10525	1.49	0.116	5.19	0.05825	-0.371		
0.084	-1.11	0.09475	0.371	0.1055	1.49	0.11625	3.34	0.05875	0		
0.08425	0.371	0.095	0.371	0.10575	1.49	0.1165	2.23	0.05925	-0.743		
0.0845	1.11	0.09525	0	0.106	1.86	0.11675	0.371	0.05975	-0.186		
0.08475	1.86	0.0955	0.371	0.10625	1.86	0.117	-1.11	0.06025	-0.371		
0.085	0	0.09575	0.371	0.1065	1.49	0.11725	-2.6	0.06075	-0.186		
0.08525	-0.743	0.096	1.11	0.10675	0.743			0.06125	-0.371		
0.0855	-0.371	0.09625	1.11	0.107	0.743			0.06175	-0.371		
0.08575	0.371	0.0965	1.11	0.10725	0.743			0.06225	-0.371		
0.086	-0.371	0.09675	1.49	0.1075	0.743			0.06275	0		
0.08625	0.743	0.097	1.49	0.10775	0.371			0.06325	-0.371		
0.0865	1.86	0.09725	1.11	0.108	0.371			0.06375	-0.186		
0.08675	3.34	0.0975	1.11	0.10825	0			0.06425	-0.371		
0.087	3.34	0.09775	0.743	0.1085	0			0.06475	-0.371		
0.08725	2.97	0.098	0	0.10875	0.371			0.06525	-0.371		
0.0875	1.86	0.09825	0	0.109	0.371			0.06575	-0.557		
0.08775	1.11	0.0985	0	0.10925	0			0.06625	-0.557		
0.088	0.743	0.09875	-0.371	0.1095	0.371			0.06675	-0.371		
0.08825	0.371	0.099	-0.371	0.10975	0.743			0.06725	-0.743		
0.0885	0	0.09925	-0.371	0.11	0.371			0.06775	-0.371		
0.08875	0	0.0995	-0.371	0.11025	0.371			0.06825	-0.743		
0.089	-0.371	0.09975	0	0.1105	-0.371			0.06875	-0.371		
0.08925	-0.371	0.1	-0.371	0.11075	-0.371			0.06925	-0.743		
0.0895	-0.371	0.10025	-0.743	0.111	0			0.06975	-0.186		
0.08975	0.371	0.1005	-1.11	0.11125	0			0.07025	-0.371		
0.09	1.11	0.10075	-0.743	0.1115	-0.371			0.07075	-0.557		
0.09025	0.743	0.101	-0.743	0.11175	0			0.07125	-0.186		
0.0905	0.371	0.10125	-0.743	0.112	0			0.07175	-0.186		
0.09075	0	0.1015	-0.743	0.11225	0.371			0.07225	-0.371		
0.091	-0.743	0.10175	-0.743	0.1125	0			0.07275	-0.186		
0.09125	-0.743	0.102	-0.743	0.11275	0.371			0.07325	-0.371		
0.0915	-0.743	0.10225	-0.743	0.113	1.11			0.07375	-0.371		
0.09175	-0.371	0.1025	0	0.11325	2.23			0.07425	0		
0.092	0	0.10275	0	0.1135	2.97			0.07475	-0.371		
0.09225	0	0.103	-0.371	0.11375	4.82			0.07525	-0.371		
0.0925	0.371	0.10325	-0.371	0.114	5.19			0.07575	-0.371		
0.09275	-0.371	0.1035	0.371	0.11425	6.68			0.07625	-0.371		

Gauge18_5	Gauge18_5	Gauge18_5	Gauge18_5	Gauge18_6	Gauge18_6	Gauge18_6	Gauge18_6	Gauge18_6	Gauge18_6	Gauge18_6	Gauge18_6
Time	Stress	Time	Stress	Time	Stress	Time	Stress	Time	Stress	Time	Stress
msec	MPa	msec	MPa	msec	MPa	msec	MPa	msec	MPa	msec	MPa
0.07675	-0.557	0.09825	-1.49	0.14525	0	0.156	0	0.16675	0	0.1775	0
0.07725	-0.186	0.09875	-0.929	0.1455	-0.371	0.15625	-0.186	0.167	-0.186	0.17775	-0.371
0.07775	-0.371	0.09925	-0.186	0.14575	-0.186	0.1565	0	0.16725	0	0.178	-0.186
0.07825	-0.557	0.09975	0.186	0.146	0	0.15675	0	0.1675	0	0.17825	0
0.07875	-0.186	0.10025	0	0.14625	-0.186	0.157	0	0.16775	0.186	0.1785	0
0.07925	-0.186	0.10075	0.557	0.1465	0	0.15725	-0.186	0.168	-1.11	0.17875	0.186
0.07975	-0.557	0.10125	0	0.14675	0	0.1575	0	0.16825	-0.371	0.179	0.186
0.08025	0	0.10175	0	0.147	0	0.15775	0	0.1685	0	0.17925	0.186
0.08075	-0.186	0.10225	0	0.14725	-0.186	0.158	-0.186	0.16875	0.186	0.1795	0.186
0.08125	-0.929	0.10275	-0.557	0.1475	-0.186	0.15825	0	0.169	0.557	0.17975	0.186
0.08175	-2.42	0.10325	-0.371	0.14775	-0.186	0.1585	0	0.16925	1.11	0.18	-0.186
0.08225	-3.53	0.10375	-0.186	0.148	-0.186	0.15875	-0.186	0.1695	-0.186	0.18025	-0.186
0.08275	-0.929	0.10425	0.371	0.14825	-0.371	0.159	-0.371	0.16975	0	0.1805	0.186
0.08325	0	0.10475	0.557	0.1485	0	0.15925	0	0.17	-0.929	0.18075	0.371
0.08375	0	0.10525	0	0.14875	0	0.1595	0.186	0.17025	-0.186	0.181	0.371
0.08425	0.186	0.10575	0.186	0.149	0	0.15975	0.186	0.1705	-0.557	0.18125	0.371
0.08475	1.86	0.10625	0	0.14925	-0.186	0.16	0	0.17075	0.186	0.1815	0.928
0.08525	1.11	0.10675	0	0.1495	-0.186	0.16025	0	0.171	0	0.18175	1.67
0.08575	0.557	0.10725	0.186	0.14975	-0.186	0.1605	0	0.17125	0.743	0.182	2.6
0.08625	1.67	0.10775	0.371	0.15	0	0.16075	0	0.1715	0.371	0.18225	3.71
0.08675	0.928	0.10825	0.186	0.15025	-0.186	0.161	-0.186	0.17175	0.371	0.1825	4.45
0.08725	-2.04	0.10875	0.371	0.1505	0	0.16125	-0.186	0.172	-0.186	0.18275	5.57
0.08775	0.557	0.10925	0.186	0.15075	0	0.1615	-0.186	0.17225	-0.186	0.183	6.31
0.08825	0.371	0.10975	0.557	0.151	0	0.16175	0	0.1725	-0.371	0.18325	7.6
0.08875	-1.11	0.11025	0.186	0.15125	0	0.162	0	0.17275	0.557	0.1835	9.83
0.08925	-0.929	0.11075	0.743	0.1515	0	0.16225	-0.371	0.173	-0.371	0.18375	11.49
0.08975	-0.557	0.11125	0.186	0.15175	-0.186	0.1625	-0.371	0.17325	-0.743	0.184	11.86
0.09025	-0.929	0.11175	0.743	0.152	-0.186	0.16275	0	0.1735	0	0.18425	12.6
0.09075	-0.186	0.11225	0.928	0.15225	-0.186	0.163	0.186	0.17375	-0.186	0.1845	12.6
0.09125	-5.39	0.11275	0.928	0.1525	-0.186	0.16325	0.557	0.174	0.557	0.18475	13.34
0.09175	-0.371	0.11325	0.743	0.15275	0	0.1635	0.186	0.17425	0.557	0.185	13.52
0.09225	0.928	0.11375	2.97	0.153	0	0.16375	-0.186	0.1745	0.743	0.18525	14.45
0.09275	-0.557	0.11425	8.53	0.15325	0	0.164	-0.557	0.17475	0.186	0.1855	13.89
0.09325	-2.23	0.11475	17.22	0.1535	0	0.16425	-0.743	0.175	0	0.18575	13.15
0.09375	-6.13	0.11525	18.51	0.15375	0	0.1645	-0.557	0.17525	-0.371	0.186	11.12
0.09425	-0.929	0.11575	9.09	0.154	0	0.16475	-0.371	0.1755	-0.371	0.18625	7.79
0.09475	-3.34	0.11625	0.928	0.15425	0	0.165	-0.371	0.17575	-0.371	0.1865	6.31
0.09525	-2.04			0.1545	-0.186	0.16525	0.186	0.176	-0.371	0.18675	4.08
0.09575	-2.42			0.15475	-0.186	0.1655	0.186	0.17625	0.186	0.187	2.23
0.09625	0.186			0.155	-0.186	0.16575	0.186	0.1765	0.186	0.18725	0
0.09675	0			0.15525	-0.186	0.166	0	0.17675	0.371	0.1875	-0.557
0.09725	-0.743			0.1555	-0.186	0.16625	-0.186	0.177	0	0.18775	-2.42
0.09775	-2.42			0.15575	0	0.1665	-0.371	0.17725	-0.186	0.188	-3.53



Gauge20_1 Time msec	Gauge20_1 Stress MPa	Gauge20_1 Time msec	Gauge20_1 Stress MPa	Gauge20_1 Time msec	Gauge20_1 Stress MPa	Gauge20_1 Time msec	Gauge20_1 Stress MPa	Gauge20_1 Time msec	Gauge20_1 Stress MPa
-0.0155	28.1997	-0.00475	0	0.006	83.7527	0.01675	-57.2458	0.0275	-57.2458
-0.01525	0	-0.0045	0	0.00625	83.7527	0.017	-115.62	0.02775	-57.2458
-0.015	0	-0.00425	28.1997	0.0065	111.106	0.01725	-28.4818	0.028	-28.4818
-0.01475	0	-0.004	28.1997	0.00675	28.1997	0.0175	-115.62	0.02825	-57.2458
-0.0145	0	-0.00375	0	0.007	-28.4818	0.01775	-86.2918	0.0285	-28.4818
-0.01425	0	-0.0035	28.1997	0.00725	56.1172	0.018	-86.2918	0.02875	-28.4818
-0.014	-28.4818	-0.00325	0	0.0075	83.7527	0.01825	-28.4818	0.029	-28.4818
-0.01375	0	-0.003	0	0.00775	28.1997	0.0185	-57.2458	0.02925	0
-0.0135	0	-0.00275	28.1997	0.008	28.1997	0.01875	-57.2458	0.0295	-57.2458
-0.01325	0	-0.0025	28.1997	0.00825	0	0.019	-57.2458	0.02975	-57.2458
-0.013	0	-0.00225	-28.4818	0.0085	0	0.01925	-115.62	0.03	-28.4818
-0.01275	0	-0.002	28.1997	0.00875	28.1997	0.0195	-57.2458	0.03025	0
-0.0125	28.1997	-0.00175	0	0.009	83.7527	0.01975	-86.2918	0.0305	28.1997
-0.01225	0	-0.0015	-28.4818	0.00925	111.106	0.02	-57.2458	0.03075	-57.2458
-0.012	0	-0.00125	0	0.0095	83.7527	0.02025	-86.2918	0.031	-57.2458
-0.01175	0	-0.001	0	0.00975	111.106	0.0205	-86.2918	0.03125	-28.4818
-0.0115	0	-0.00075	0	0.01	111.106	0.02075	-86.2918	0.0315	0
-0.01125	0	-0.0005	28.1997	0.01025	83.7527	0.021	-145.23	0.03175	0
-0.011	0	-0.00025	28.1997	0.0105	83.7527	0.02125	-86.2918	0.032	-57.2458
-0.01075	0	0	0	0.01075	83.7527	0.0215	-86.2918	0.03225	-28.4818
-0.0105	0	0.00025	83.7527	0.011	56.1172	0.02175	-57.2458	0.0325	-57.2458
-0.01025	0	0.0005	111.106	0.01125	28.1997	0.022	-28.4818	0.03275	-28.4818
-0.01	0	0.00075	515.715	0.0115	0	0.02225	-28.4818	0.033	-28.4818
-0.00975	-28.4818	0.001	985.263	0.01175	0	0.0225	-86.2918	0.03325	-86.2918
-0.0095	0	0.00125	1072.06	0.012	28.1997	0.02275	-28.4818	0.0335	-57.2458
-0.00925	0	0.0015	1072.06	0.01225	28.1997	0.023	-28.4818	0.03375	-57.2458
-0.009	-28.4818	0.00175	985.263	0.0125	-28.4818	0.02325	-57.2458	0.034	-57.2458
-0.00875	0	0.002	1028.46	0.01275	0	0.0235	-28.4818	0.03425	-28.4818
-0.0085	28.1997	0.00225	942.525	0.013	0	0.02375	-28.4818	0.0345	-28.4818
-0.00825	0	0.0025	900.287	0.01325	28.1997	0.024	0	0.03475	-28.4818
-0.008	0	0.00275	858.595	0.0135	0	0.02425	-28.4818	0.035	-28.4818
-0.00775	0	0.003	777.032	0.01375	28.1997	0.0245	-28.4818	0.03525	-86.2918
-0.0075	0	0.00325	622.522	0.014	28.1997	0.02475	-28.4818	0.0355	-28.4818
-0.00725	0	0.0035	482.111	0.01425	28.1997	0.025	0	0.03575	-28.4818
-0.007	0	0.00375	449.592	0.0145	-28.4818	0.02525	0	0.036	-57.2458
-0.00675	0	0.004	388.022	0.01475	-57.2458	0.0255	-28.4818	0.03625	-57.2458
-0.0065	28.1997	0.00425	243.641	0.015	-28.4818	0.02575	-57.2458	0.0365	-86.2918
-0.00625	28.1997	0.0045	191.473	0.01525	-28.4818	0.026	-28.4818	0.03675	-86.2918
-0.006	0	0.00475	138.177	0.0155	-57.2458	0.02625	28.1997	0.037	-57.2458
-0.00575	0	0.005	164.966	0.01575	-86.2918	0.0265	28.1997	0.03725	-57.2458
-0.0055	0	0.00525	138.177	0.016	-115.62	0.02675	0	0.0375	-57.2458
-0.00525	-28.4818	0.0055	138.177	0.01625	-28.4818	0.027	0	0.03775	-28.4818
-0.005	28.1997	0.00575	138.177	0.0165	-57.2458	0.02725	0	0.038	-57.2458

Gauge20_2 Time msec	Gauge20_2 Stress MPa	Gauge20_2 Time msec	Gauge20_2 Stress MPa	Gauge20_2 Time msec	Gauge20_2 Stress MPa	Gauge20_2 Time msec	Gauge20_2 Stress MPa	Gauge20_2 Time msec	Gauge20_2 Stress MPa
0.032	-2.87754	0.04275	-1.75677	0.0535	-1.89949	0.06425	9.41441	0.075	4.63331
0.03225	-2.74865	0.043	-0.208953	0.05375	0.0809016	0.0645	9.41441	0.07525	3.09797
0.0325	-2.64888	0.04325	-3.6521	0.054	-2.00461	0.06475	11.5826	0.0755	3.70055
0.03275	-4.05082	0.0435	-4.59935	0.05425	-1.69092	0.065	10.4987	0.07575	4.52029
0.033	-4.91321	0.04375	-4.18885	0.0545	-1.145	0.06525	11.5826	0.076	4.3338
0.03325	-3.90992	0.044	-6.30264	0.05475	-1.83802	0.0655	12.666	0.07625	3.78596
0.0335	-4.71808	0.04425	-4.34318	0.055	-2.23121	0.06575	11.5826	0.0765	4.07804
0.03375	-3.95401	0.0445	-5.00829	0.05525	-0.299586	0.066	13.7491	0.07675	4.00174
0.034	-4.07033	0.04475	-0.431174	0.0555	-3.30163	0.06625	14.11	0.077	3.28658
0.03425	-4.3222	0.045	-2.43327	0.05575	-2.22655	0.0665	13.3881	0.07725	4.03978
0.0345	-3.92288	0.04525	0.610077	0.056	-0.753807	0.06675	13.0271	0.0775	4.52807
0.03475	-2.25782	0.0455	1.93541	0.05625	-1.50028	0.067	12.666	0.07775	3.88928
0.035	-3.40624	0.04575	4.17781	0.0565	-2.09405	0.06725	11.5826	0.078	3.57066
0.03525	-2.85904	0.046	3.67532	0.05675	-0.920517	0.0675	11.5826	0.07825	4.06339
0.0355	-3.4886	0.04625	3.11648	0.057	-1.85131	0.06775	10.86	0.0785	4.67864
0.03575	-2.85695	0.0465	3.78798	0.05725	-0.932442	0.068	9.77588	0.07875	4.29116
0.036	-2.84158	0.04675	5.26915	0.0575	-0.80472	0.06825	9.77588	0.079	3.86312
0.03625	-3.19894	0.047	2.3906	0.05775	-1.58802	0.0685	11.2213	0.07925	3.61248
0.0365	-4.06659	0.04725	2.32148	0.058	-2.12873	0.06875	9.41441	0.0795	4.64068
0.03675	-4.0733	0.0475	2.51786	0.05825	-1.20026	0.069	10.4987	0.07975	4.63075
0.037	-3.54561	0.04775	1.93368	0.0585	-1.01207	0.06925	11.9438	0.08	4.11143
0.03725	-3.38826	0.048	2.54945	0.05875	-1.81125	0.0695	10.1373	0.08025	3.93067
0.0375	-3.82186	0.04825	2.86769	0.059	-1.24816	0.06975	10.4987	0.0805	4.66149
0.03775	-4.64319	0.0485	2.27496	0.05925	-1.56263	0.07	11.5826	0.08075	4.54377
0.038	-3.85215	0.04875	47.1944	0.0595	-0.849267	0.07025	7.96805	0.081	3.51744
0.03825	-3.54805	0.049	6.7299	0.05975	-0.061775	0.0705	10.86	0.08125	4.48931
0.0385	-4.25198	0.04925	5.51133	0.06	-0.131119	0.07075	12.3049	0.0815	3.54521
0.03875	-4.39521	0.0495	4.80531	0.06025	-1.04702	0.071	10.86	0.08175	3.8746
0.039	-4.54661	0.04975	6.16521	0.0605	0.655793	0.07125	11.5826	0.082	4.28725
0.03925	-5.03797	0.05	7.65431	0.06075	0.221828	0.0715	11.2213	0.08225	3.8717
0.0395	-4.0283	0.05025	6.67479	0.061	7.96805	0.07175	10.1373	0.0825	4.22954
0.03975	-4.16424	0.0505	5.37045	0.06125	9.05288	0.072	10.4987	0.08275	3.40389
0.04	-4.12343	0.05075	1.74714	0.0615	7.60634	0.07225	9.41441	0.083	4.2556
0.04025	-4.85139	0.051	0.93157	0.06175	18.7979	0.0725	6.8828	0.08325	3.09332
0.0405	-0.606706	0.05125	2.11233	0.062	17.3563	0.07275	7.60634	0.0835	3.54962
0.04075	-1.44021	0.0515	0.187774	0.06225	19.5185	0.073	6.8828	0.08375	3.72376
0.041	-1.66795	0.05175	-2.70838	0.0625	24.9166	0.07325	5.79713	0.084	3.91419
0.04125	2.29224	0.052	-1.11567	0.06275	19.1582	0.0735	5.79713	0.08425	3.34001
0.0415	0.59398	0.05225	-2.80745	0.063	18.0772	0.07375	4.18461	0.0845	3.70222
0.04175	2.85534	0.0525	-2.16146	0.06325	16.6352	0.074	4.60868	0.08475	3.92797
0.042	0.889405	0.05275	-1.48201	0.0635	10.1373	0.07425	4.35562	0.085	3.5376
0.04225	2.27642	0.053	-1.84633	0.06375	9.41441	0.0745	4.73322	0.08525	3.1767
0.0425	1.00858	0.05325	-2.17132	0.064	11.9438	0.07475	4.24132	0.0855	3.3736

Gauge20_2 Time msec	Gauge20_2 Stress MPa	Gauge20_2 Time msec	Gauge20_2 Stress MPa	Gauge20_2 Time msec	Gauge20_2 Stress MPa	Gauge20_2 Time msec	Gauge20_2 Stress MPa	Gauge20_2 Time msec	Gauge20_2 Stress MPa
0.08575	3.96913	0.0965	7.56152	0.10725	7.21663	0.118	5.32385	0.12875	5.79713
0.086	4.08833	0.09675	8.27877	0.1075	4.78666	0.11825	5.76651	0.129	2.1753
0.08625	3.76775	0.097	6.68614	0.10775	5.86814	0.1185	5.49857	0.12925	2.1753
0.0865	4.57844	0.09725	7.9682	0.108	6.66693	0.11875	5.1775	0.1295	2.90003
0.08675	3.92014	0.0975	7.35301	0.10825	5.92834	0.119	5.19276	0.12975	2.90003
0.087	3.31788	0.09775	7.69571	0.1085	4.71789	0.11925	5.95095	0.13	2.53768
0.08725	4.09751	0.098	7.312	0.10875	5.16339	0.1195	5.54927	0.13025	2.53768
0.0875	4.4634	0.09825	7.27871	0.109	6.60749	0.11975	5.78116	0.1305	0.362663
0.08775	4.38047	0.0985	6.85156	0.10925	5.44346	0.12	5.4567	0.13075	1.08785
0.088	4.8968	0.09875	7.73375	0.1095	4.97177	0.12025	6.42953		
0.08825	5.15144	0.099	6.41837	0.10975	5.52417	0.1205	5.62542		
0.0885	4.86506	0.09925	6.86402	0.11	5.51272	0.12075	5.78324		
0.08875	3.78922	0.0995	6.50671	0.11025	5.51012	0.121	6.32177		
0.089	5.69276	0.09975	6.41607	0.1105	4.62223	0.12125	6.52095		
0.08925	5.6032	0.1	6.89562	0.11075	5.29534	0.1215	5.07313		
0.0895	5.37085	0.10025	7.06877	0.111	5.24757	0.12175	6.15907		
0.08975	5.25147	0.1005	5.79023	0.11125	4.08895	0.122	4.34895		
0.09	6.14032	0.10075	6.04285	0.1115	5.53267	0.12225	5.07313		
0.09025	7.01618	0.101	6.4497	0.11175	3.75369	0.1225	6.52095		
0.0905	5.78019	0.10125	6.52229	0.112	5.74597	0.12275	6.52095		
0.09075	5.7172	0.1015	5.73282	0.11225	4.58745	0.123	6.8828		
0.091	6.89399	0.10175	6.50119	0.1125	3.89354	0.12325	6.15907		
0.09125	7.05528	0.102	6.20613	0.11275	4.25579	0.1235	6.52095		
0.0915	6.60271	0.10225	5.13974	0.113	4.39945	0.12375	6.15907		
0.09175	7.33898	0.1025	6.24121	0.11325	4.56821	0.124	2.90003		
0.092	6.73577	0.10275	6.58578	0.1135	3.48292	0.12425	5.07313		
0.09225	7.94704	0.103	6.35705	0.11375	4.03984	0.1245	4.71106		
0.0925	6.55354	0.10325	5.90178	0.114	4.419	0.12475	-2.17694		
0.09275	8.83362	0.1035	5.24414	0.11425	4.54191	0.125	3.62458		
0.093	7.78019	0.10375	6.15068	0.1145	3.18778	0.12525	4.34895		
0.09325	7.86851	0.104	5.76604	0.11475	4.4701	0.1255	2.53768		
0.0935	7.06015	0.10425	6.51589	0.115	4.66801	0.12575	3.26233		
0.09375	7.90607	0.1045	6.73482	0.11525	3.99774	0.126	2.90003		
0.094	7.62235	0.10475	4.89938	0.1155	3.76209	0.12625	3.26233		
0.09425	9.31992	0.105	5.98239	0.11575	4.61553	0.1265	4.34895		
0.0945	8.16634	0.10525	6.31715	0.116	4.10253	0.12675	3.26233		
0.09475	8.33366	0.1055	5.92722	0.11625	4.96585	0.127	3.62458		
0.095	6.95809	0.10575	6.3744	0.1165	4.60792	0.12725	3.98679		
0.09525	7.75318	0.106	5.54319	0.11675	4.84555	0.1275	3.62458		
0.0955	8.37364	0.10625	6.35705	0.117	4.55921	0.12775	2.90003		
0.09575	7.82958	0.1065	5.89133	0.11725	4.13353	0.128	3.26233		
0.096	8.24267	0.10675	6.24824	0.1175	5.48751	0.12825	4.34895		
0.09625	8.30927	0.107	4.90032	0.11775	4.40852	0.1285	5.07313		

Gauge20_3 Time msec	Gauge20_3 Stress MPa	Gauge20_3 Time msec	Gauge20_3 Stress MPa	Gauge20_3 Time msec	Gauge20_3 Stress MPa	Gauge20_4 Time msec	Gauge20_4 Stress MPa	Gauge20_4 Time msec	Gauge20_4 Stress MPa
0.017	0	0.0385	0.359156	0.06	20.0431	0.087	0	0.09775	-0.364131
0.0175	0	0.039	0.718267	0.0605	25.0317	0.08725	-0.364131	0.098	-0.364131
0.018	0.359156	0.0395	0.359156	0.061	20.0431	0.0875	-0.364131	0.09825	-0.364131
0.0185	0.359156	0.04	0	0.0615	1.43635	0.08775	0	0.0985	-0.364131
0.019	0.359156	0.0405	0.359156	0.062	-6	0.088	-0.364131	0.09875	0
0.0195	0.359156	0.041	0			0.08825	0	0.099	-0.364131
0.02	0.359156	0.0415	1.07733			0.0885	0	0.09925	-0.364131
0.0205	0.359156	0.042	1.07733			0.08875	0	0.0995	-0.364131
0.021	0	0.0425	2.15426			0.089	-0.364131	0.09975	0
0.0215	0.359156	0.043	0			0.08925	-0.364131	0.1	0
0.022	0	0.0435	-0.359201			0.0895	0	0.10025	0
0.0225	0.359156	0.044	0			0.08975	-0.364131	0.1005	0
0.023	0	0.0445	0			0.09	-0.364131	0.10075	0
0.0235	0.359156	0.045	1.07733			0.09025	0	0.101	0
0.024	0.359156	0.0455	1.43635			0.0905	-0.364131	0.10125	0
0.0245	0.359156	0.046	1.07733			0.09075	0	0.1015	0
0.025	0.359156	0.0465	-0.718448			0.091	0	0.10175	-0.364131
0.0255	0	0.047	-0.359201			0.09125	0	0.102	0
0.026	0.359156	0.0475	0			0.0915	-0.364131	0.10225	0
0.0265	0.359156	0.048	0			0.09175	-0.364131	0.1025	0
0.027	0.359156	0.0485	0.359156			0.092	-0.364131	0.10275	0.364086
0.0275	0	0.049	0			0.09225	-0.364131	0.103	0
0.028	0.359156	0.0495	-1.07774			0.0925	-0.364131	0.10325	-0.364131
0.0285	0	0.05	1.07733			0.09275	0	0.1035	0
0.029	0	0.0505	1.07733			0.093	0	0.10375	-0.364131
0.0295	0	0.051	-1.79646			0.09325	-0.364131	0.104	-0.364131
0.03	0.359156	0.0515	1.43635			0.0935	-0.364131	0.10425	0
0.0305	0.359156	0.052	1.07733			0.09375	0	0.1045	0
0.031	0	0.0525	-0.359201			0.094	0	0.10475	0
0.0315	0	0.053	-0.359201			0.09425	-0.364131	0.105	0.364086
0.032	0.359156	0.0535	-0.359201			0.0945	0	0.10525	0
0.0325	0.359156	0.054	-0.718448			0.09475	-0.364131	0.1055	0
0.033	0.359156	0.0545	0			0.095	0	0.10575	0
0.0335	0.359156	0.055	0.718267			0.09525	-0.364131	0.106	-0.364131
0.034	0	0.0555	0			0.0955	-0.364131	0.10625	-0.364131
0.0345	0	0.056	0.359156			0.09575	-0.364131	0.1065	0
0.035	0.359156	0.0565	-0.359201			0.096	0	0.10675	0
0.0355	0.359156	0.057	0			0.09625	-0.728309	0.107	-0.364131
0.036	0.359156	0.0575	0.359156			0.0965	-0.364131	0.10725	-0.364131
0.0365	0.359156	0.058	0.359156			0.09675	-0.364131	0.1075	0
0.037	0.359156	0.0585	1.43635			0.097	0	0.10775	-0.364131
0.0375	0	0.059	4.30689			0.09725	-0.364131	0.108	0
0.038	0	0.0595	11.1128			0.0975	-0.364131	0.10825	-0.364131

Gauge20_4 Time msec	Gauge20_4 Stress MPa	Gauge20_4 Time msec	Gauge20_4 Stress MPa	Gauge20_4 Time msec	Gauge20_4 Stress MPa	Gauge20_4 Time msec	Gauge20_4 Stress MPa	Gauge20_4 Time msec	Gauge20_4 Stress MPa
0.1085	0	0.11925	21.4026	0.13	5.45647	0.14075	6.90979	0.1515	4.65825
0.10875	0	0.1195	22.8479	0.13025	5.45647	0.141	6.18322	0.15175	3.77147
0.109	-0.364131	0.11975	23.5702	0.1305	5.09303	0.14125	5.81987	0.152	3.88508
0.10925	0	0.12	22.1253	0.13075	5.09303	0.1415	5.45647	0.15225	3.77494
0.1095	-0.364131	0.12025	18.1481	0.131	5.09303	0.14175	5.09303	0.1525	3.2282
0.10975	0	0.1205	14.1654	0.13125	5.09303	0.142	5.09303	0.15275	2.70323
0.11	0	0.12075	10.9026	0.1315	5.09303	0.14225	5.09303	0.153	3.26304
0.11025	0	0.121	10.5399	0.13175	5.09303	0.1425	5.81987	0.15325	1.99204
0.1105	0	0.12125	9.81422	0.132	4.72954	0.14275	5.81987	0.1535	2.26996
0.11075	-0.364131	0.1215	7.63617	0.13225	4.366	0.143	5.45647	0.15375	2.63693
0.111	-0.364131	0.12175	6.18322	0.1325	4.00242	0.14325	5.45647	0.154	1.70116
0.11125	0	0.122	7.273	0.13275	4.72954	0.1435	5.45647	0.15425	1.61311
0.1115	0	0.12225	7.63617	0.133	4.366	0.14375	5.45647	0.1545	2.69133
0.11175	0	0.1225	7.99929	0.13325	4.72954	0.144	5.09303	0.15475	1.31013
0.112	0	0.12275	7.273	0.1335	5.45647	0.14425	5.09303	0.155	2.6896
0.11225	0	0.123	6.54653	0.13375	5.09303	0.1445	2.9114	0.15525	2.82586
0.1125	0	0.12325	6.54653	0.134	5.45647	0.14475	2.65378	0.1555	3.50626
0.11275	0	0.1235	5.81987	0.13425	4.00242	0.145	2.09529	0.15575	2.94808
0.113	0	0.12375	5.81987	0.1345	3.63879	0.14525	2.95232	0.156	4.81148
0.11325	-0.364131	0.124	6.18322	0.13475	4.72954	0.1455	2.07989	0.15625	4.62178
0.1135	0	0.12425	6.54653	0.135	4.72954	0.14575	2.26524	0.1565	6.17545
0.11375	0	0.1245	6.90979	0.13525	5.45647	0.146	2.68672	0.15675	5.73631
0.114	0	0.12475	7.63617	0.1355	5.09303	0.14625	1.56354	0.157	7.02176
0.11425	0	0.125	7.99929	0.13575	5.45647	0.1465	2.84847	0.15725	7.60727
0.1145	0	0.12525	7.99929	0.136	5.09303	0.14675	0.883356	0.1575	7.55599
0.11475	0	0.1255	7.99929	0.13625	5.09303	0.147	1.84441	0.15775	8.65957
0.115	0	0.12575	7.273	0.1365	5.09303	0.14725	2.00194	0.158	9.0268
0.11525	0	0.126	6.54653	0.13675	5.09303	0.1475	2.34391	0.15825	9.51077
0.1155	-0.364131	0.12625	6.18322	0.137	5.45647	0.14775	1.27176	0.1585	10.216
0.11575	0	0.1265	5.81987	0.13725	5.81987	0.148	2.50687	0.15875	9.71638
0.116	0.364086	0.12675	5.45647	0.1375	5.81987	0.14825	2.26027	0.159	9.34619
0.11625	0	0.127	6.18322	0.13775	6.90979	0.1485	2.13662	0.15925	9.97869
0.1165	0.364086	0.12725	5.81987	0.138	6.18322	0.14875	2.79324	0.1595	9.33715
0.11675	0.728125	0.1275	5.81987	0.13825	5.81987	0.149	2.80754	0.15975	9.76404
0.117	1.45607	0.12775	5.09303	0.1385	5.81987	0.14925	3.20367	0.16	8.41833
0.11725	5.81987	0.128	5.09303	0.13875	5.81987	0.1495	3.2994	0.16025	9.05222
0.1175	6.18322	0.12825	5.09303	0.139	6.90979	0.14975	4.12167	0.1605	8.43408
0.11775	7.273	0.1285	5.45647	0.13925	6.54653	0.15	3.31456	0.16075	6.98527
0.118	10.5399	0.12875	5.09303	0.1395	6.18322	0.15025	4.22751	0.161	7.99716
0.11825	15.6143	0.129	4.72954	0.13975	5.81987	0.1505	4.55095	0.16125	5.66221
0.1185	17.7863	0.12925	5.45647	0.14	5.81987	0.15075	3.89281	0.1615	6.63104
0.11875	18.1481	0.1295	5.45647	0.14025	5.81987	0.151	4.46442	0.16175	5.48079
0.119	19.595	0.12975	5.45647	0.1405	7.63617	0.15125	3.97126	0.162	5.17814

Gauge20_4 Time msec	Gauge20_4 Stress MPa	Gauge20_4 Time msec	Gauge20_4 Stress MPa	Gauge20_4 Time msec	Gauge20_4 Stress MPa	Gauge20_4 Time msec	Gauge20_4 Stress MPa	Gauge20_5 Time msec	Gauge20_5 Stress MPa
0.16225	5.07192	0.173	1.84444	0.18375	7.67831	0.1945	9.82405	0.092	0.176511
0.1625	4.46531	0.17325	1.69953	0.184	9.95618	0.19475	7.91016	0.0925	0.5295
0.16275	4.34784	0.1735	2.5843	0.18425	9.79092	0.195	10.8207	0.093	0.176511
0.163	4.59372	0.17375	3.44522	0.1845	11.5251	0.19525	8.04104	0.0935	-0.176522
0.16325	3.97682	0.174	3.05385	0.18475	10.4466	0.1955	8.48508	0.094	0.353011
0.1635	4.18591	0.17425	5.26661	0.185	12.3662	0.19575	8.62729	0.0945	0
0.16375	5.03386	0.1745	5.20448	0.18525	11.5262	0.196	7.92033	0.095	0
0.164	3.57227	0.17475	6.00718	0.1855	12.1105	0.19625	7.45221	0.0955	0.176511
0.16425	4.8081	0.175	7.69549	0.18575	11.6365	0.1965	7.98645	0.096	0.176511
0.1645	5.1847	0.17525	8.09377	0.186	11.8248	0.19675	6.7133	0.0965	-0.176522
0.16475	4.08711	0.1755	9.32057	0.18625	11.0141	0.197	7.74498	0.097	-0.176522
0.165	5.88488	0.17575	10.7511	0.1865	11.289	0.19725	6.75126	0.0975	0.176511
0.16525	5.23237	0.176	9.87895	0.18675	9.6166	0.1975	7.47119	0.098	0
0.1655	6.11943	0.17625	12.4915	0.187	9.92842	0.19775	6.91324	0.0985	0.176511
0.16575	5.59645	0.1765	11.4586	0.18725	8.41589	0.198	7.03983	0.099	0.176511
0.166	6.24335	0.17675	12.8576	0.1875	7.51313	0.19825	7.24151	0.0995	0.176511
0.16625	6.86264	0.177	12.9905	0.18775	6.90825	0.1985	7.52414	0.1	0.176511
0.1665	5.62459	0.17725	12.6309	0.188	5.88184	0.19875	6.82664	0.1005	0.176511
0.16675	7.24581	0.1775	13.1662	0.18825	4.77317	0.199	7.96027	0.101	0.176511
0.167	5.77069	0.17775	11.9571	0.1885	4.32717	0.19925	7.2474	0.1015	0
0.16725	6.83294	0.178	12.674	0.18875	3.54984	0.1995	7.4468	0.102	0
0.1675	6.2449	0.17825	11.7389	0.189	2.19782	0.19975	7.2172	0.1025	0
0.16775	6.31749	0.1785	11.9403	0.18925	2.85306	0.2	7.40672	0.103	0
0.168	6.21057	0.17875	11.1407	0.1895	1.96947	0.20025	7.33299	0.1035	-0.176522
0.16825	5.06475	0.179	10.2266	0.18975	1.94416	0.2005	7.22261	0.104	-0.176522
0.1685	5.82511	0.17925	9.96683	0.19	1.80824	0.20075	6.67786	0.1045	0
0.16875	4.04225	0.1795	9.79716	0.19025	2.25292	0.201	6.48259	0.105	0
0.169	4.37092	0.17975	7.82585	0.1905	1.70642	0.20125	5.77394	0.1055	0.176511
0.16925	3.96714	0.18	7.67371	0.19075	2.18772	0.2015	6.37235	0.106	0.176511
0.1695	3.32872	0.18025	7.26223	0.191	3.0372			0.1065	0.353011
0.16975	2.84744	0.1805	5.996	0.19125	4.23982			0.107	-0.176522
0.17	1.81966	0.18075	5.77831	0.1915	3.8352			0.1075	0.5295
0.17025	3.00915	0.181	5.42404	0.19175	5.42365			0.108	0.353011
0.1705	0.801976	0.18125	5.27487	0.192	4.47679			0.1085	0.176511
0.17075	1.89458	0.1815	5.63633	0.19225	6.73082			0.109	0.176511
0.171	0.748322	0.18175	5.12069	0.1925	6.13499			0.1095	0.176511
0.17125	0.293761	0.182	5.18864	0.19275	8.59076			0.11	-0.176522
0.1715	0.883169	0.18225	5.63735	0.193	7.27286			0.1105	0
0.17175	0.44692	0.1825	5.78855	0.19325	6.69309			0.111	-0.176522
0.172	0.36547	0.18275	6.22153	0.1935	8.67452			0.1115	0
0.17225	0.837536	0.183	7.19834	0.19375	8.4227			0.112	-0.176522
0.1725	1.22394	0.18325	6.9116	0.194	8.91714			0.1125	-0.176522
0.17275	0.755978	0.1835	9.40509	0.19425	9.22911			0.113	0.176511

Gauge20_5 Time msec	Gauge20_5 Stress MPa	Gauge20_6 Time msec	Gauge20_6 Stress MPa	Gauge20_6 Time msec	Gauge20_6 Stress MPa
0.1135	0.353011	0.165	0	0.1865	0.889206
0.114	0.176511	0.1655	0.177864	0.187	1.06701
0.1145	0.353011	0.166	0	0.1875	2.31135
0.115	0.176511	0.1665	0	0.188	4.44323
0.1155	0.176511	0.167	0	0.1885	6.04108
0.116	0.5295	0.1675	0	0.189	6.75094
0.1165	0.5295	0.168	0.177864	0.1895	8.34748
0.117	0.176511	0.1685	0	0.19	10.2976
0.1175	0	0.169	0	0.1905	10.652
0.118	0	0.1695	0	0.191	5.50856
0.1185	0.176511	0.17	0.177864	0.1915	-6.76711
0.119	1.0589	0.1705	0		
0.1195	4.40944	0.171	0.177864		
0.12	7.05177	0.1715	0		
0.1205	11.2743	0.172	-0.177875		
0.121	14.7882	0.1725	0.177864		
0.1215	16.017	0.173	0		
0.122	12.1532	0.1735	0.177864		
0.1225	-6	0.174	0		
		0.1745	0.355716		
		0.175	-0.177875		
		0.1755	0		
		0.176	0.177864		
		0.1765	0		
		0.177	0		
		0.1775	0		
		0.178	0.177864		
		0.1785	0		
		0.179	0		
		0.1795	0.177864		
		0.18	0.177864		
		0.1805	-0.177875		
		0.181	0.177864		
		0.1815	0		
		0.182	0.177864		
		0.1825	0.177864		
		0.183	0.177864		
		0.1835	0.355716		
		0.184	0.355716		
		0.1845	0.355716		
		0.185	0.355716		
		0.1855	0.355716		
		0.186	0.355716		

Gauge21_1 Time msec	Gauge21_1 Stress MPa	Gauge21_1 Time msec	Gauge21_1 Stress MPa	Gauge21_1 Time msec	Gauge21_1 Stress MPa	Gauge21_1 Time msec	Gauge21_1 Stress MPa	Gauge21_1 Time msec	Gauge21_1 Stress MPa
-0.02275	-28.1021	-0.012	0	-0.00125	27.8237	0.0095	55.369	0.02025	-28.1021
-0.0225	-28.1021	-0.01175	27.8237	-0.001	0	0.00975	27.8237	0.0205	-28.1021
-0.02225	0	-0.0115	27.8237	-0.00075	0	0.01	0	0.02075	-56.4825
-0.022	0	-0.01125	0	-0.0005	27.8237	0.01025	-56.4825	0.021	-56.4825
-0.02175	0	-0.011	27.8237	-0.00025	27.8237	0.0105	-28.1021	0.02125	-56.4825
-0.0215	0	-0.01075	0	0	0	0.01075	-56.4825	0.0215	-28.1021
-0.02125	0	-0.0105	27.8237	0.00025	136.335	0.011	0	0.02175	-56.4825
-0.021	0	-0.01025	27.8237	0.0005	240.392	0.01125	0	0.022	-28.1021
-0.02075	0	-0.01	0	0.00075	382.542	0.0115	-28.1021	0.02225	27.8237
-0.0205	0	-0.00975	27.8237	0.001	648.018	0.01175	0	0.0225	0
-0.02025	0	-0.0095	-28.1021	0.00125	965.389	0.012	55.369	0.02275	0
-0.02	0	-0.00925	0	0.0015	1092.94	0.01225	27.8237	0.023	0
-0.01975	0	-0.009	0	0.00175	1092.94	0.0125	0	0.02325	27.8237
-0.0195	27.8237	-0.00875	27.8237	0.002	1050.05	0.01275	27.8237	0.0235	27.8237
-0.01925	0	-0.0085	0	0.00225	965.389	0.013	55.369	0.02375	0
-0.019	0	-0.00825	27.8237	0.0025	882.501	0.01325	27.8237	0.024	0
-0.01875	0	-0.008	0	0.00275	841.83	0.0135	-56.4825	0.02425	-56.4825
-0.0185	0	-0.00775	27.8237	0.003	882.501	0.01375	-28.1021	0.0245	0
-0.01825	0	-0.0075	0	0.00325	841.83	0.014	0	0.02475	-56.4825
-0.018	0	-0.00725	0	0.0035	685.354	0.01425	27.8237	0.025	0
-0.01775	0	-0.007	0	0.00375	474.428	0.0145	-56.4825	0.02525	-56.4825
-0.0175	0	-0.00675	27.8237	0.004	412.029	0.01475	-85.1413	0.0255	0
-0.01725	0	-0.0065	0	0.00425	327.256	0.015	-56.4825	0.02575	-56.4825
-0.017	-28.1021	-0.00625	27.8237	0.0045	240.392	0.01525	0	0.026	-56.4825
-0.01675	27.8237	-0.006	27.8237	0.00475	240.392	0.0155	-28.1021	0.02625	-56.4825
-0.0165	27.8237	-0.00575	27.8237	0.005	188.92	0.01575	-28.1021	0.0265	-28.1021
-0.01625	0	-0.0055	0	0.00525	162.767	0.016	27.8237	0.02675	0
-0.016	27.8237	-0.00525	0	0.0055	82.636	0.01625	82.636	0.027	0
-0.01575	0	-0.005	27.8237	0.00575	0	0.0165	0	0.02725	0
-0.0155	0	-0.00475	27.8237	0.006	-28.1021	0.01675	-28.1021	0.0275	0
-0.01525	0	-0.0045	27.8237	0.00625	-143.294	0.017	-28.1021	0.02775	27.8237
-0.015	-28.1021	-0.00425	0	0.0065	-85.1413	0.01725	55.369	0.028	55.369
-0.01475	0	-0.004	27.8237	0.00675	0	0.0175	27.8237	0.02825	27.8237
-0.0145	0	-0.00375	0	0.007	82.636	0.01775	27.8237	0.0285	0
-0.01425	27.8237	-0.0035	27.8237	0.00725	188.92	0.018	-28.1021		
-0.014	-28.1021	-0.00325	0	0.0075	162.767	0.01825	-28.1021		
-0.01375	27.8237	-0.003	-28.1021	0.00775	27.8237	0.0185	0		
-0.0135	27.8237	-0.00275	27.8237	0.008	55.369	0.01875	-28.1021		
-0.01325	27.8237	-0.0025	27.8237	0.00825	27.8237	0.019	27.8237		
-0.013	0	-0.00225	0	0.0085	55.369	0.01925	27.8237		
-0.01275	-28.1021	-0.002	27.8237	0.00875	109.625	0.0195	0		
-0.0125	0	-0.00175	27.8237	0.009	162.767	0.01975	-56.4825		
-0.01225	27.8237	-0.0015	0	0.00925	109.625	0.02	-28.1021		

Gauge21_2 Time msec	Gauge21_2 Stress MPa	Gauge21_2 Time msec	Gauge21_2 Stress MPa	Gauge21_2 Time msec	Gauge21_2 Stress MPa	Gauge21_2 Time msec	Gauge21_2 Stress MPa	Gauge21_2 Time msec	Gauge21_2 Stress MPa
0.05225	0	0.063	0	0.07375	10.2575	0.0845	11.7199	0.09525	3.30101
0.0525	-0.734066	0.06325	0.366964	0.074	8.79438	0.08475	10.9888	0.0955	3.66756
0.05275	0	0.0635	0.366964	0.07425	8.06253	0.085	9.16023	0.09575	2.20109
0.053	0.733881	0.06375	0.366964	0.0745	6.96441	0.08525	9.16023	0.096	0.733881
0.05325	0	0.064	0	0.07475	7.3305	0.0855	9.8918	0.09625	0.366964
0.0535	0	0.06425	0	0.075	7.3305	0.08575	8.06253	0.0965	1.46758
0.05375	0	0.0645	0.366964	0.07525	6.96441	0.086	6.96441	0.09675	4.03406
0.054	0	0.06475	-0.36701	0.0755	6.96441	0.08625	8.79438	0.097	2.93442
0.05425	-0.36701	0.065	0	0.07575	8.42848	0.0865	9.8918	0.09725	5.86588
0.0545	-0.36701	0.06525	0.366964	0.076	7.3305	0.08675	8.06253	0.0975	11.7199
0.05475	0	0.0655	0	0.07625	6.59828	0.087	5.86588	0.09775	8.42848
0.055	0	0.06575	-0.734066	0.0765	7.69654	0.08725	5.86588	0.098	4.03406
0.05525	-0.36701	0.066	1.10075	0.07675	10.6232	0.0875	6.59828	0.09825	3.30101
0.0555	0	0.06625	0.733881	0.077	6.96441	0.08775	4.76692	0.0985	0.366964
0.05575	0	0.0665	0	0.07725	5.86588	0.088	5.13329	0.09875	-1.46832
0.056	0	0.06675	1.10075	0.0775	8.79438	0.08825	5.13329	0.099	1.10075
0.05625	0	0.067	1.46758	0.07775	8.79438	0.0885	5.86588	0.09925	1.10075
0.0565	0.366964	0.06725	1.83436	0.078	5.86588	0.08875	3.66756	0.0995	1.10075
0.05675	0	0.0675	2.93442	0.07825	6.2321	0.089	4.03406	0.09975	0.733881
0.057	0	0.06775	5.4996	0.0785	8.06253	0.08925	4.40052	0.1	0.366964
0.05725	0	0.068	9.52604	0.07875	9.52604	0.0895	3.66756	0.10025	-2.20275
0.0575	0	0.06825	1.46425	0.079	9.16023	0.08975	4.40052	0.1005	-2.93737
0.05775	0	0.0685	19.0208	0.07925	10.6232	0.09	4.40052	0.10075	1.10075
0.058	0	0.06875	26.3033	0.0795	10.6232	0.09025	1.83436	0.101	1.83436
0.05825	0	0.069	24.8483	0.07975	9.16023	0.0905	0.733881	0.10125	-1.10117
0.0585	0.366964	0.06925	24.4844	0.08	8.06253	0.09075	1.83436	0.1015	-1.10117
0.05875	0	0.0695	26.3033	0.08025	8.06253	0.091	0	0.10175	-1.10117
0.059	0	0.06975	28.4844	0.0805	8.42848	0.09125	1.10075	0.102	-0.734066
0.05925	0.366964	0.07	26.3033	0.08075	8.79438	0.0915	2.93442	0.10225	-0.734066
0.0595	0	0.07025	22.6644	0.081	9.8918	0.09175	2.93442	0.1025	-0.734066
0.05975	0	0.0705	20.4788	0.08125	9.8918	0.092	-0.734066	0.10275	-1.10117
0.06	0	0.07075	16.8325	0.0815	9.16023	0.09225	0	0.103	-0.36701
0.06025	0	0.071	12.4508	0.08175	9.52604	0.0925	0.733881	0.10325	-1.10117
0.0605	0	0.07125	10.6232	0.082	8.79438	0.09275	1.83436	0.1035	-1.46832
0.06075	0	0.0715	10.9888	0.08225	9.52604	0.093	2.56778	0.10375	0
0.061	-0.36701	0.07175	10.6232	0.0825	16.1027	0.09325	2.56778	0.104	-0.36701
0.06125	1.10075	0.072	10.2575	0.08275	12.0854	0.0935	2.56778	0.10425	-0.734066
0.0615	0.366964	0.07225	10.2575	0.083	9.52604	0.09375	2.56778	0.1045	-0.734066
0.06175	-0.36701	0.0725	10.6232	0.08325	8.79438	0.094	4.76692	0.10475	0
0.062	-0.734066	0.07275	10.9888	0.0835	9.16023	0.09425	4.40052	0.105	0.366964
0.06225	0.366964	0.073	10.9888	0.08375	17.1973	0.0945	1.83436	0.10525	-2.20275
0.0625	0.366964	0.07325	10.9888	0.084	15.0076	0.09475	2.56778	0.1055	-2.93737
0.06275	0	0.0735	11.3544	0.08425	10.2575	0.095	1.10075	0.10575	0.366964

Gauge21_2 Time msec	Gauge21_2 Stress MPa	Gauge21_3 Time msec	Gauge21_3 Stress MPa	Gauge21_3 Time msec	Gauge21_3 Stress MPa	Gauge21_3 Time msec	Gauge21_3 Stress MPa	Gauge21_3 Time msec	Gauge21_3 Stress MPa
0.106	1.10075	0.02975	0	0.05125	0	0.07275	5.88915	0.09425	4.78584
0.10625	0	0.03025	0.36842	0.05175	0	0.07325	4.05007	0.09475	11.0324
0.1065	2.20109	0.03075	-0.368466	0.05225	0.36842	0.07375	4.78584	0.09525	2.20982
0.10675	2.20109	0.03125	0.36842	0.05275	0	0.07425	4.78584	0.09575	9.93106
0.107	-2.20275	0.03175	0	0.05325	0.36842	0.07475	10.2982	0.09625	10.6653
0.10725	-1.10117	0.03225	0	0.05375	0.36842	0.07525	6.99205	0.09675	2.94606
0.1075	-1.46832	0.03275	0	0.05425	-0.368466	0.07575	8.82927	0.09725	9.19658
0.10775	-0.734066	0.03325	0	0.05475	0	0.07625	9.19658	0.09775	9.56384
0.108	-0.734066	0.03375	-0.368466	0.05525	0	0.07675	11.3994	0.09825	9.93106
0.10825	-2.20275	0.03425	-0.368466	0.05575	0	0.07725	9.19658	0.09875	6.62446
0.1085	-2.20275	0.03475	0.36842	0.05625	-0.368466	0.07775	6.62446	0.09925	12.5003
0.10875	-2.57004	0.03525	0.736794	0.05675	0.36842	0.07825	8.46192	0.09975	8.46192
0.109	-4.03965	0.03575	0.36842	0.05725	-0.368466	0.07875	6.99205	0.10025	16.1666
0.10925	-3.30475	0.03625	0	0.05775	0	0.07925	6.99205	0.10075	3.68211
0.1095	-2.93737	0.03675	0	0.05825	0.36842	0.07975	15.8002	0.10125	5.52143
0.10975	-5.14235	0.03725	0	0.05875	0.36842	0.08025	8.09452	0.10175	6.99205
0.11	-5.51	0.03775	0	0.05925	0.736794	0.08075	5.88915	0.10225	13.6006
0.11025	-5.87771	0.03825	0.36842	0.05975	0.736794	0.08125	5.88915	0.10275	12.1334
0.1105	-6.61325	0.03875	0.36842	0.06025	2.20982	0.08175	5.52143	0.10325	6.62446
0.11075	-7.34898	0.03925	0.36842	0.06075	6.99205	0.08225	5.88915	0.10375	6.62446
0.111	-7.34898	0.03975	0	0.06125	20.9259	0.08275	4.78584	0.10425	-4.79368
0.11125	-5.51	0.04025	0	0.06175	30.0564	0.08325	7.72708	0.10475	4.41798
0.1115	-5.51	0.04075	0	0.06225	31.1501	0.08375	6.62446	0.10525	3.31411
0.11175	-5.87771	0.04125	0	0.06275	19.4623	0.08425	8.09452	0.10575	3.31411
0.112	-5.14235	0.04175	0.36842	0.06325	11.0324	0.08475	2.94606	0.10625	11.0324
0.11225	-5.51	0.04225	0.36842	0.06375	11.7664	0.08525	4.05007	0.10675	1.4734
0.1125	-5.51	0.04275	0	0.06425	12.8671	0.08575	3.68211	0.10725	1.10512
0.11275	-5.51	0.04325	0	0.06475	12.5003	0.08625	3.31411	0.10775	2.20982
0.113	-6.98109	0.04375	0	0.06525	8.09452	0.08675	4.41798	0.10825	2.94606
0.11325	-6.61325	0.04425	0	0.06575	7.72708	0.08725	6.25683	0.10875	1.84164
0.1135	-5.87771	0.04475	0.36842	0.06625	7.35958	0.08775	8.46192	0.10925	2.94606
0.11375	-5.51	0.04525	0.36842	0.06675	7.72708	0.08825	7.72708	0.10975	3.68211
0.114	-5.14235	0.04575	0.36842	0.06725	6.99205	0.08875	9.93106	0.11025	0
0.11425	-5.87771	0.04625	0.36842	0.06775	6.99205	0.08925	1.84164	0.11075	0.736794
		0.04675	0.36842	0.06825	6.99205	0.08975	5.52143	0.11125	3.31411
		0.04725	0	0.06875	7.35958	0.09025	7.35958	0.11175	11.0324
		0.04775	0.36842	0.06925	8.09452	0.09075	9.56384	0.11225	7.72708
		0.04825	0.36842	0.06975	8.09452	0.09125	-13.294	0.11275	6.99205
		0.04875	0	0.07025	7.72708	0.09175	5.52143	0.11325	10.6653
		0.04925	0	0.07075	7.72708	0.09225	4.41798	0.11375	9.56384
		0.04975	0	0.07125	6.62446	0.09275	7.72708	0.11425	12.8671
		0.05025	0.36842	0.07175	6.62446	0.09325	13.6006	0.11475	11.7664
		0.05075	0	0.07225	4.78584	0.09375	12.8671	0.11525	19.8283

Gauge21_3 Time msec	Gauge21_3 Stress MPa	Gauge21_3 Time msec	Gauge21_3 Stress MPa	Gauge21_4 Time msec	Gauge21_4 Stress MPa	Gauge21_4 Time msec	Gauge21_4 Stress MPa	Gauge21_4 Time msec	Gauge21_4 Stress MPa
0.11575	21.2917	0.13725	4.78584	0.07225	0	0.083	0.362663	0.09375	0.362663
0.11625	21.6574	0.13775	5.15366	0.0725	0.362663	0.08325	0	0.094	0.362663
0.11675	16.1666	0.13825	4.05007	0.07275	0.362663	0.0835	-0.362709	0.09425	0
0.11725	17.998	0.13875	6.99205	0.073	0.362663	0.08375	0.362663	0.0945	0
0.11775	1.84164	0.13925	4.41798	0.07325	0.362663	0.084	0	0.09475	0
0.11825	16.8993	0.13975	-1.10554	0.0735	0	0.08425	0.362663	0.095	0
0.11875	8.82927	0.14025	0	0.07375	0.362663	0.0845	0.362663	0.09525	0
0.11925	6.99205	0.14075	-0.736979	0.074	0.362663	0.08475	0.725281	0.0955	0
0.11975	4.41798	0.14125	-1.47414	0.07425	0.725281	0.085	1.08785	0.09575	0
0.12025	5.52143	0.14175	-1.8426	0.0745	0.725281	0.08525	1.45038	0.096	0.362663
0.12075	5.88915			0.07475	0.362663	0.0855	1.45038	0.09625	0.362663
0.12125	6.62446			0.075	0.362663	0.08575	0.725281	0.0965	0.362663
0.12175	-1.8428			0.07525	0	0.086	0.362663	0.09675	0.362663
0.12225	-0.368466			0.0755	0.725281	0.08625	-0.362709	0.097	0.362663
0.12275	13.2339			0.07575	0.725281	0.0865	-0.362709	0.09725	0.362663
0.12325	11.7664			0.076	0.725281	0.08675	-0.362709	0.0975	0.362663
0.12375	5.52143			0.07625	0.362663	0.087	0	0.09775	0.362663
0.12425	2.94606			0.0765	0.362663	0.08725	-0.725464	0.098	0.362663
0.12475	5.88915			0.07675	0.725281	0.0875	-0.725464	0.09825	0.362663
0.12525	5.15366			0.077	0.362663	0.08775	-0.362709	0.0985	0.725281
0.12575	0.736794			0.07725	0.725281	0.088	-0.362709	0.09875	0.362663
0.12625	1.10512			0.0775	0.362663	0.08825	0	0.099	0.362663
0.12675	0.36842			0.07775	0.362663	0.0885	0	0.09925	0.362663
0.12725	-9.96488			0.078	0.362663	0.08875	0	0.0995	0.362663
0.12775	2.94606			0.07825	0	0.089	0	0.09975	0.362663
0.12825	2.94606			0.0785	0	0.08925	0	0.1	0
0.12875	1.4734			0.07875	0	0.0895	0	0.10025	0
0.12925	6.99205			0.079	0	0.08975	0.362663	0.1005	0.362663
0.12975	3.31411			0.07925	0	0.09	0	0.10075	0
0.13025	1.4734			0.0795	0	0.09025	0	0.101	0.362663
0.13075	4.05007			0.07975	0	0.0905	0.725281	0.10125	0.362663
0.13125	15.8002			0.08	0	0.09075	0.362663	0.1015	0.362663
0.13175	8.46192			0.08025	0	0.091	0.362663	0.10175	0.362663
0.13225	8.82927			0.0805	0.362663	0.09125	0.362663	0.102	0
0.13275	6.99205			0.08075	0.725281	0.0915	0.362663	0.10225	0
0.13325	11.7664			0.081	0.725281	0.09175	0.362663	0.1025	0.362663
0.13375	13.6006			0.08125	0.725281	0.092	0	0.10275	0.362663
0.13425	16.1666			0.0815	0.362663	0.09225	0	0.103	-0.362709
0.13475	-9.22558			0.08175	0.725281	0.0925	0	0.10325	0.362663
0.13525	5.52143			0.082	0.725281	0.09275	0	0.1035	0.362663
0.13575	4.41798			0.08225	0.362663	0.093	0.362663	0.10375	0.362663
0.13625	6.25683			0.0825	0.362663	0.09325	0.362663	0.104	0
0.13675	7.72708			0.08275	0.362663			0.10425	0.362663

Gauge21_4 Time msec	Gauge21_4 Stress MPa	Gauge21_4 Time msec	Gauge21_4 Stress MPa	Gauge21_4 Time msec	Gauge21_4 Stress MPa	Gauge21_4 Time msec	Gauge21_4 Stress MPa	Gauge21_4 Time msec	Gauge21_4 Stress MPa
0.1045	0.362663	0.11525	0	0.126	-0.362709	0.13675	-2.53992	0.1475	-2.17694
0.10475	0.362663	0.1155	6.4426E-13	0.12625	-0.725464	0.137	-2.53992	0.14775	-3.99231
0.105	0.362663	0.11575	0	0.1265	-0.362709	0.13725	-2.90295	0.148	-3.62915
0.10525	0.362663	0.116	0	0.12675	0	0.1375	-2.53992	0.14825	-3.26603
0.1055	0.362663	0.11625	6.4426E-13	0.127	-0.362709	0.13775	-1.814	0.1485	-2.53992
0.10575	0	0.1165	0	0.12725	-0.725464	0.138	-1.814	0.14875	-2.17694
0.106	0	0.11675	0	0.1275	0	0.13825	-1.08826	0.149	-2.17694
0.10625	0	0.117	-0.362709	0.12775	-1.45111	0.1385	-1.08826	0.14925	-1.45111
0.1065	-0.362709	0.11725	0	0.128	0	0.13875	-1.45111	0.1495	-1.45111
0.10675	0	0.1175	-0.362709	0.12825	-2.17694	0.139	-1.45111	0.14975	-1.08826
0.107	0	0.11775	0.362663	0.1285	-2.53992	0.13925	-1.08826	0.15	-0.725464
0.10725	-0.362709	0.118	0.362663	0.12875	-2.53992	0.1395	-1.45111	0.15025	-0.725464
0.1075	0.362663	0.11825	0.362663	0.129	-2.53992	0.13975	-1.45111	0.1505	-0.725464
0.10775	0	0.1185	0.362663	0.12925	-2.90295	0.14	-1.45111	0.15075	-0.725464
0.108	0.362663	0.11875	0.362663	0.1295	-3.26603	0.14025	-1.45111	0.151	-0.362709
0.10825	0.362663	0.119	0.725281	0.12975	-2.90295	0.1405	-1.45111	0.15125	0.725281
0.1085	0	0.11925	1.45038	0.13	-3.26603	0.14075	-1.814	0.1515	0.362663
0.10875	0	0.1195	1.45038	0.13025	-3.26603	0.141	-1.814	0.15175	0.362663
0.109	0	0.11975	2.53768	0.1305	-2.53992	0.14125	-2.17694	0.152	-0.362709
0.10925	0	0.12	3.98679	0.13075	-2.53992	0.1415	-2.17694	0.15225	-1.08826
0.1095	-0.362709	0.12025	7.24459	0.131	-2.90295	0.14175	-2.17694	0.1525	-1.45111
0.10975	-0.362709	0.1205	12.666	0.13125	-2.90295	0.142	-2.17694	0.15275	-2.17694
0.11	-0.362709	0.12075	19.1582	0.1315	-2.90295	0.14225	-2.17694	0.153	-1.08826
0.11025	0	0.121	24.5571	0.13175	-2.90295	0.1425	-2.17694	0.15325	-1.45111
0.1105	0	0.12125	26.7137	0.132	-3.26603	0.14275	-2.17694	0.1535	-0.725464
0.11075	-0.362709	0.1215	25.995	0.13225	-2.90295	0.143	-1.45111	0.15375	-0.725464
0.111	-0.362709	0.12175	23.1184	0.1325	-2.90295	0.14325	-1.08826	0.154	-0.725464
0.11125	-0.362709	0.122	18.4376	0.13275	-2.90295	0.1435	-1.08826	0.15425	-0.362709
0.1115	0	0.12225	14.8318	0.133	-2.90295	0.14375	-1.45111	0.1545	-0.725464
0.11175	-0.362709	0.1225	12.666	0.13325	-2.53992	0.144	-1.45111	0.15475	-0.725464
0.112	-0.362709	0.12275	11.9438	0.1335	-2.90295	0.14425	-1.45111	0.155	-1.45111
0.11225	-0.362709	0.123	11.2213	0.13375	-2.90295	0.1445	-2.17694	0.15525	-1.08826
0.1125	-0.362709	0.12325	9.05288	0.134	-2.90295	0.14475	-2.90295	0.1555	-0.362709
0.11275	-0.362709	0.1235	6.52095	0.13425	-2.90295	0.145	-2.53992	0.15575	-0.725464
0.113	-0.362709	0.12375	5.07313	0.1345	-2.90295	0.14525	-2.17694	0.156	-1.08826
0.11325	-0.362709	0.124	3.26233	0.13475	-2.53992	0.1455	-1.45111	0.15625	-1.08826
0.1135	0	0.12425	1.45038	0.135	-2.53992	0.14575	-2.53992	0.1565	-1.814
0.11375	-0.362709	0.1245	-0.725464	0.13525	-2.90295	0.146	-2.53992	0.15675	-1.45111
0.114	0	0.12475	-2.53992	0.1355	-2.53992	0.14625	-2.17694	0.157	-1.08826
0.11425	0	0.125	-2.53992	0.13575	-2.53992	0.1465	-2.17694	0.15725	0
0.1145	0	0.12525	-1.814	0.136	-2.17694	0.14675	-2.17694	0.1575	0
0.11475	0	0.1255	-2.17694	0.13625	-1.814	0.147	-1.45111	0.15775	-1.814
0.115	0	0.12575	-1.45111	0.1365	-2.17694	0.14725	-1.45111	0.158	-2.17694

Gauge21_4	Gauge21_4	Gauge21_4	Gauge21_4	Gauge21_4	Gauge21_4	Gauge21_4	Gauge21_4	Gauge21_4	Gauge21_4
Time	Stress	Time	Stress	Time	Stress	Time	Stress	Time	Stress
msec	MPa	msec	MPa	msec	MPa	msec	MPa	msec	MPa
0.15825	-1.814	0.169	-2.53992	0.17975	0	0.1905	-4.35552	0.20125	-0.725464
0.1585	-1.08826	0.16925	-1.814	0.18	-1.814	0.19075	8.69132	0.2015	-2.53992
0.15875	-1.08826	0.1695	-1.814	0.18025	-2.53992	0.191	4.34895	0.20175	0.725281
0.159	-1.08826	0.16975	-1.08826	0.1805	-2.53992	0.19125	-0.725464	0.202	7.96805
0.15925	-1.08826	0.17	0.725281	0.18075	-2.90295	0.1915	1.45038	0.20225	6.52095
0.1595	-1.45111	0.17025	2.1753	0.181	-2.53992	0.19175	1.81286	0.2025	2.53768
0.15975	-2.90295	0.1705	1.81286	0.18125	-2.53992	0.192	3.26233	0.20275	1.81286
0.16	-2.17694	0.17075	1.08785	0.1815	-0.725464	0.19225	1.81286	0.203	0
0.16025	-2.53992	0.171	0.725281	0.18175	-1.08826	0.1925	1.45038	0.20325	-3.99231
0.1605	-1.814	0.17125	-0.725464	0.182	0.362663	0.19275	0.362663	0.2035	-5.44543
0.16075	-3.26603	0.1715	1.08785	0.18225	1.45038	0.193	-3.62915	0.20375	1.45038
0.161	-3.26603	0.17175	1.45038	0.1825	1.81286	0.19325	1.08785	0.204	5.43516
0.16125	-2.90295	0.172	0.362663	0.18275	1.08785	0.1935	2.1753	0.20425	2.90003
0.1615	-2.90295	0.17225	1.45038	0.183	0.725281	0.19375	2.1753	0.2045	5.79713
0.16175	-2.90295	0.1725	3.26233	0.18325	3.26233	0.194	0	0.20475	3.62458
0.162	-3.99231	0.17275	-0.362709	0.1835	1.45038	0.19425	-2.17694	0.205	0.725281
0.16225	-2.90295	0.173	-0.725464	0.18375	-0.362709	0.1945	2.53768	0.20525	-0.362709
0.1625	-2.90295	0.17325	1.08785	0.184	0.362663	0.19475	7.24459	0.2055	0.725281
0.16275	-2.90295	0.1735	1.08785	0.18425	1.08785	0.195	4.71106	0.20575	2.1753
0.163	-1.45111	0.17375	1.45038	0.1845	1.45038	0.19525	2.53768	0.206	6.15907
0.16325	-1.45111	0.174	1.45038	0.18475	2.1753	0.1955	1.81286	0.20625	2.90003
0.1635	-2.17694	0.17425	1.08785	0.185	1.81286	0.19575	-1.45111	0.2065	-2.53992
0.16375	-1.45111	0.1745	-1.08826	0.18525	-3.62915	0.196	-2.90295	0.20675	-0.725464
0.164	-0.725464	0.17475	-2.17694	0.1855	-2.17694	0.19625	0.725281	0.207	0
0.16425	-0.725464	0.175	-2.53992	0.18575	0.362663	0.1965	1.08785	0.20725	-1.08826
0.1645	-2.90295	0.17525	-2.53992	0.186	-5.08208	0.19675	3.26233	0.2075	-3.99231
0.16475	-3.26603	0.1755	-2.17694	0.18625	-10.9011	0.197	0	0.20775	-5.08208
0.165	-1.08826	0.17575	-1.814	0.1865	-6.53575	0.19725	3.62458	0.208	-3.62915
0.16525	0.362663	0.176	-5.08208	0.18675	2.1753	0.1975	3.62458	0.20825	-1.814
0.1655	-0.725464	0.17625	-1.814	0.187	0.362663	0.19775	0.725281	0.2085	-1.45111
0.16575	-1.814	0.1765	-2.17694	0.18725	2.1753	0.198	2.1753	0.20875	-1.08826
0.166	-0.725464	0.17675	-2.53992	0.1875	7.24459	0.19825	5.79713	0.209	0
0.16625	-1.08826	0.177	-1.45111	0.18775	6.15907	0.1985	-2.90295	0.20925	-1.08826
0.1665	-0.725464	0.17725	0	0.188	2.53768	0.19875	-3.62915	0.2095	-1.814
0.16675	-0.362709	0.1775	-0.725464	0.18825	-0.725464	0.199	-3.99231	0.20975	0
0.167	-1.08826	0.17775	0	0.1885	0	0.19925	-1.45111	0.21	2.90003
0.16725	-0.725464	0.178	-0.362709	0.18875	-3.26603	0.1995	-0.362709	0.21025	2.90003
0.1675	0.362663	0.17825	-1.08826	0.189	-3.62915	0.19975	-1.45111	0.2105	2.90003
0.16775	0.725281	0.1785	0	0.18925	-5.44543	0.2	-1.814	0.21075	2.53768
0.168	0.362663	0.17875	-1.814	0.1895	-4.71878	0.20025	1.08785	0.211	3.62458
0.16825	-1.45111	0.179	-2.17694	0.18975	-2.17694	0.2005	0.362663	0.21125	4.71106
0.1685	-1.814	0.17925	-2.53992	0.19	-2.53992	0.20075	-1.08826	0.2115	3.62458
0.16875	-2.17694	0.1795	-0.362709	0.19025	-4.71878	0.201	0.362663	0.21175	2.1753

Gauge21_4	Gauge21_4	Gauge21_5	Gauge21_5	Gauge21_5	Gauge21_5	Gauge21_5	Gauge21_5	Gauge21_5	Gauge21_5
Time	Stress	Time	Stress	Time	Stress	Time	Stress	Time	Stress
msec	MPa	msec	MPa	msec	MPa	msec	MPa	msec	MPa
0.212	4.71106	0.07975	0.360551	0.10125	0	0.12275	-0.721238	0.14425	-6.31699
0.21225	5.07313	0.08025	0.180281	0.10175	0.180281	0.12325	-2.52513	0.14475	-6.31699
0.2125	4.34895	0.08075	0.180281	0.10225	0	0.12375	-3.4275	0.14525	-1.62304
0.21275	3.98679	0.08125	0.360551	0.10275	0.180281	0.12425	-1.98384	0.14575	-0.901576
0.213	4.34895	0.08175	0.180281	0.10325	0	0.12475	-1.98384	0.14625	-5.23309
0.21325	4.34895	0.08225	0.180281	0.10375	0	0.12525	-1.62304	0.14675	2.88314
0.2135	3.26233	0.08275	0.180281	0.10425	-0.180292	0.12575	-1.44266	0.14725	-2.34469
0.21375	2.90003	0.08325	0.360551	0.10475	0.180281	0.12625	-2.34469	0.14775	-5.41371
0.214	3.26233	0.08375	-0.180292	0.10525	0.180281	0.12675	-2.88604	0.14825	-0.901576
0.21425	2.53768	0.08425	0.360551	0.10575	0	0.12725	-4.1496	0.14875	-5.77499
0.2145	2.1753	0.08475	0.180281	0.10625	0.180281	0.12775	-3.78852	0.14925	-7.03982
0.21475	1.81286	0.08525	0	0.10675	0.360551	0.12825	-4.1496	0.14975	-5.77499
0.215	1.81286	0.08575	0.180281	0.10725	0.180281	0.12875	-4.33015	0.15025	-3.96906
0.21525	-4.71878	0.08625	-0.180292	0.10775	-0.180292	0.12925	-4.51072	0.15075	-5.95564
0.2155	-7.99015	0.08675	-0.360596	0.10825	-0.360596	0.12975	-5.41371	0.15125	-5.95564
0.21575	-1.814	0.08725	-0.180292	0.10875	-0.180292	0.13025	-5.59434	0.15175	-7.94361
0.216	1.81286	0.08775	0	0.10925	-0.540911	0.13075	-5.59434	0.15225	-7.94361
0.21625	1.45038	0.08825	-0.180292	0.10975	-0.540911	0.13125	-5.23309	0.15275	-3.247
0.2165	0	0.08875	-0.180292	0.11025	-0.180292	0.13175	-4.87188	0.15325	-1.62304
0.21675	-0.362709	0.08925	-0.360596	0.11075	-0.180292	0.13225	-5.05248	0.15375	-3.60801
0.217	-0.362709	0.08975	-0.360596	0.11125	0	0.13275	-4.69129	0.15425	-3.96906
0.21725	1.08785	0.09025	-0.180292	0.11175	-0.180292	0.13325	-4.69129	0.15475	-3.06652
0.2175	1.81286	0.09075	-0.360596	0.11225	0	0.13375	-4.1496	0.15525	-2.52513
0.21775	1.45038	0.09125	-0.540911	0.11275	0	0.13425	-3.96906	0.15575	-2.52513
0.218	1.45038	0.09175	-0.360596	0.11325	0	0.13475	-3.4275	0.15625	-4.51072
0.21825	1.81286	0.09225	-0.360596	0.11375	0.360551	0.13525	-3.247	0.15675	-1.98384
0.2185	0.362663	0.09275	-0.721238	0.11425	0.180281	0.13575	-3.247	0.15725	-4.33015
0.21875	-0.362709	0.09325	-0.360596	0.11475	0.540809	0.13625	-3.78852	0.15775	-3.96906
0.219	0	0.09375	-0.540911	0.11525	0.180281	0.13675	-4.1496	0.15825	-4.69129
0.21925	0	0.09425	-0.180292	0.11575	0	0.13725	-4.33015	0.15875	-1.62304
0.2195	0.362663	0.09475	-0.360596	0.11625	0.180281	0.13775	-4.1496	0.15925	-5.05248
0.21975	0	0.09525	-0.180292	0.11675	-0.540911	0.13825	-4.69129	0.15975	-5.05248
0.22	-0.725464	0.09575	-0.180292	0.11725	-0.180292	0.13875	-5.77499	0.16025	-3.60801
0.22025	-1.08826	0.09625	0.180281	0.11775	0.180281	0.13925	-7.4013	0.16075	-3.06652
0.2205	-0.725464	0.09675	0.360551	0.11825	0.901292	0.13975	-6.67838	0.16125	-2.88604
0.22075	-1.08826	0.09725	0.540809	0.11875	2.88314	0.14025	-5.77499	0.16175	-2.88604
0.221	-1.814	0.09775	0.721056	0.11925	8.10141	0.14075	-7.58206	0.16225	-4.51072
0.22125	-2.17694	0.09825	0	0.11975	1.4566	0.14125	-5.95564	0.16275	-3.60801
0.2215	-1.814	0.09875	0.180281	0.12025	13.669	0.14175	-5.59434	0.16325	-7.4013
0.22175	-2.53992	0.09925	0	0.12075	15.642	0.14225	-4.1496	0.16375	-6.67838
0.222	-2.17694	0.09975	0.360551	0.12125	10.7968	0.14275	-4.33015	0.16425	-5.9434
		0.10025	0.360551	0.12175	6.12319	0.14325	-9.02853	0.16475	-2.88604
		0.10075	0.360551	0.12225	-3.96906	0.14375	-6.13631	0.16525	-2.16426

Gauge21_5 Time msec	Gauge21_5 Stress MPa	Gauge21_5 Time msec	Gauge21_5 Stress MPa	Gauge21_5 Time msec	Gauge21_5 Stress MPa	Gauge21_6 Time msec	Gauge21_6 Stress MPa	Gauge21_6 Time msec	Gauge21_6 Stress MPa
0.16575	-5.77499	0.18725	3.60347	0.20875	0.180281	0.15275	0	0.17425	0.361252
0.16625	-7.76282	0.18775	-0.721238	0.20925	-1.98384	0.15325	-0.180643	0.17475	0.361252
0.16675	-3.78852	0.18825	-2.70558	0.20975	-2.70558	0.15375	0.361252	0.17525	0.361252
0.16725	-1.08192	0.18875	-1.80344	0.21025	-6.85909	0.15425	0	0.17575	0.361252
0.16775	-3.60801	0.18925	-0.901576	0.21075	-0.540911	0.15475	0	0.17625	0.361252
0.16825	-1.26229	0.18975	-1.98384	0.21125	-1.26229	0.15525	0	0.17675	0.180632
0.16875	-1.98384	0.19025	1.44193	0.21175	-4.1496	0.15575	0	0.17725	0.180632
0.16925	-2.52513	0.19075	3.78352	0.21225	0.360551	0.15625	0.180632	0.17775	0.180632
0.16975	-1.80344	0.19125	1.98247	0.21275	-5.23309	0.15675	0	0.17825	0.361252
0.17025	-4.69129	0.19175	-1.26229	0.21325	-7.94361	0.15725	0	0.17875	0.361252
0.17075	-5.59434	0.19225	-4.33015	0.21375	-3.78852	0.15775	0	0.17925	0.361252
0.17125	-5.05248	0.19275	-2.52513	0.21425	-5.59434	0.15825	0	0.17975	0.180632
0.17175	-8.1244	0.19325	-0.540911	0.21475	-7.03982	0.15875	0.180632	0.18025	-0.361298
0.17225	-6.49768	0.19375	-5.95564	0.21525	0	0.15925	0	0.18075	-0.361298
0.17275	-6.13631	0.19425	-3.60801	0.21575	-5.77499	0.15975	-0.180643	0.18125	0.180632
0.17325	-6.31699	0.19475	-2.16426	0.21625	-6.49768	0.16025	0.180632	0.18175	0.722459
0.17375	-4.33015	0.19525	-3.06652	0.21675	-7.22055	0.16075	0.180632	0.18225	0.361252
0.17425	-3.96906	0.19575	-3.60801	0.21725	-7.4013	0.16125	0.180632	0.18275	0.361252
0.17475	-6.85909	0.19625	-4.87188	0.21775	-6.67838	0.16175	0	0.18325	0.361252
0.17525	-7.58206	0.19675	-0.721238	0.21825	-6.67838	0.16225	-0.180643	0.18375	1.62528
0.17575	-3.96906	0.19725	-2.34469	0.21875	-6.85909	0.16275	-0.180643	0.18425	1.08362
0.17625	-7.22055	0.19775	-0.901576			0.16325	0	0.18475	0.361252
0.17675	-5.41371	0.19825	0.180281			0.16375	0.180632	0.18525	0.361252
0.17725	-4.51072	0.19875	1.62212			0.16425	0.180632	0.18575	0.541861
0.17775	-2.34469	0.19925	-1.80344			0.16475	0	0.18625	0.722459
0.17825	-3.96906	0.19975	-0.360596			0.16525	0.180632	0.18675	0.722459
0.17875	-6.13631	0.20025	-0.360596			0.16575	0	0.18725	0.722459
0.17925	-2.16426	0.20075	-1.44266			0.16625	0.180632	0.18775	0.180632
0.17975	-2.52513	0.20125	-5.23309			0.16675	0.180632	0.18825	0.722459
0.18025	-3.60801	0.20175	-6.13631			0.16725	0.180632	0.18875	1.62528
0.18075	-2.88604	0.20225	-4.87188			0.16775	0	0.18925	0.722459
0.18125	-3.247	0.20275	-7.03982			0.16825	0	0.18975	0.541861
0.18175	-3.96906	0.20325	-6.67838			0.16875	0.180632	0.19025	1.80581
0.18225	-2.70558	0.20375	-5.95564			0.16925	0.180632	0.19075	2.88874
0.18275	-3.78852	0.20425	-2.34469			0.16975	0.361252	0.19125	4.87307
0.18325	-1.08192	0.20475	-8.48601			0.17025	0.361252	0.19175	12.6168
0.18375	0	0.20525	-5.05248			0.17075	0.180632	0.19225	19.8013
0.18425	-1.26229	0.20575	-1.80344			0.17125	0.180632	0.19275	19.8013
0.18475	1.26173	0.20625	1.98247			0.17175	0.180632	0.19325	16.3909
0.18525	0.540809	0.20675	-4.1496			0.17225	0.180632	0.19375	11.3576
0.18575	1.26173	0.20725	0			0.17275	0.180632	0.19425	9.73784
0.18625	-1.62304	0.20775	0.540809			0.17325	0.180632	0.19475	6.85601
0.18675	-0.721238	0.20825	-3.60801			0.17375	0.180632	0.19525	3.43006

Gauge21_6 Time msec	Gauge21_6 Stress MPa	Gauge21_6 Time msec	Gauge21_6 Stress MPa
0.19575	7.03621	0.21725	1.08362
0.19625	3.43006	0.21775	1.80581
0.19675	4.51238	0.21825	3.61048
0.19725	5.05339	0.21875	3.24963
0.19775	5.05339	0.21925	1.44474
0.19825	4.33202	0.21975	4.33202
0.19875	4.87307	0.22025	4.87307
0.19925	5.41401	0.22075	4.33202
0.19975	5.41401	0.22125	3.97127
0.20025	5.23371	0.22175	3.97127
0.20075	4.69273	0.22225	5.95485
0.20125	5.77458	0.22275	5.05339
0.20175	5.41401	0.22325	3.06919
0.20225	5.5943	0.22375	3.43006
0.20275	5.23371	0.22425	3.97127
0.20325	4.69273	0.22475	3.43006
0.20375	4.51238	0.22525	3.43006
0.20425	4.51238	0.22575	4.69273
0.20475	5.23371	0.22625	3.79088
0.20525	5.05339	0.22675	3.43006
0.20575	4.33202	0.22725	0.903045
0.20625	3.61048	0.22775	1.80581
0.20675	3.06919		
0.20725	2.88874		
0.20775	3.61048		
0.20825	4.15165		
0.20875	4.51238		
0.20925	4.51238		
0.20975	4.33202		
0.21025	4.87307		
0.21075	6.31535		
0.21125	2.52781		
0.21175	2.16683		
0.21225	4.51238		
0.21275	4.33202		
0.21325	3.79088		
0.21375	2.34733		
0.21425	2.88874		
0.21475	3.24963		
0.21525	1.80581		
0.21575	1.44474		
0.21625	1.98632		
0.21675	1.62528		



Gauge22_1 Time msec	Gauge22_1 Stress MPa	Gauge22_1 Time msec	Gauge22_1 Stress MPa	Gauge22_1 Time msec	Gauge22_1 Stress MPa	Gauge22_1 Time msec	Gauge22_1 Stress MPa	Gauge22_1 Time msec	Gauge22_1 Stress MPa
-0.0055	-27.9954	0.003	877.543	0.01375	55.1589	0.0245	0	0.03525	27.7181
-0.00525	-27.9954	0.00325	797.341	0.014	55.1589	0.02475	-27.9954	0.0355	27.7181
-0.005	0	0.0035	608.413	0.01425	27.7181	0.025	-56.2681	0.03575	0
-0.00475	0	0.00375	472.285	0.0145	135.817	0.02525	-56.2681	0.036	0
-0.0045	0	0.004	381.013	0.01475	55.1589	0.0255	-27.9954	0.03625	0
-0.00425	0	0.00425	239.48	0.015	0	0.02575	0	0.0365	27.7181
-0.004	-27.9954	0.0045	188.203	0.01525	27.7181	0.026	0	0.03675	27.7181
-0.00375	-27.9954	0.00475	162.149	0.0155	0	0.02625	0	0.037	0
-0.0035	27.7181	0.005	213.98	0.01575	-27.9954	0.0265	0	0.03725	0
-0.00325	-27.9954	0.00525	213.98	0.016	55.1589	0.02675	0	0.0375	0
-0.003	-27.9954	0.0055	352.924	0.01625	0	0.027	0	0.03775	0
-0.00275	0	0.00575	381.013	0.0165	27.7181	0.02725	55.1589	0.038	0
-0.0025	0	0.006	300.563	0.01675	27.7181	0.0275	27.7181	0.03825	0
-0.00225	0	0.00625	300.563	0.017	-56.2681	0.02775	27.7181	0.0385	27.7181
-0.002	0	0.0065	188.203	0.01725	27.7181	0.028	82.3224	0.03875	27.7181
-0.00175	-27.9954	0.00675	0	0.0175	27.7181	0.02825	109.209	0.039	27.7181
-0.0015	-27.9954	0.007	-56.2681	0.01775	27.7181	0.0285	109.209	0.03925	27.7181
-0.00125	27.7181	0.00725	82.3224	0.018	-27.9954	0.02875	55.1589	0.0395	27.7181
-0.001	-27.9954	0.0075	82.3224	0.01825	0	0.029	82.3224	0.03975	27.7181
-0.00075	27.7181	0.00775	82.3224	0.0185	-56.2681	0.02925	55.1589	0.04	27.7181
-0.0005	0	0.008	0	0.01875	-56.2681	0.0295	109.209	0.04025	27.7181
-0.00025	0	0.00825	-56.2681	0.019	0	0.02975	82.3224	0.0405	27.7181
-0.0002	0	0.0085	-113.645	0.01925	-27.9954	0.03	82.3224	0.04075	0
-0.000175	0	0.00875	-297.838	0.0195	0	0.03025	82.3224	0.041	27.7181
-0.00015	0	0.009	-113.645	0.01975	-362.979	0.0305	55.1589	0.04125	27.7181
-0.000125	0	0.00925	0	0.02	-399.72	0.03075	55.1589	0.0415	27.7181
-0.0001	0	0.0095	0	0.02025	0	0.031	55.1589	0.04175	27.7181
-0.000075	27.7181	0.00975	-56.2681	0.0205	0	0.03125	55.1589	0.042	55.1589
-0.00005	0	0.01	109.209	0.02075	0	0.0315	55.1589	0.04225	0
-0.000025	-27.9954	0.01025	27.7181	0.021	-27.9954	0.03175	82.3224	0.0425	0
0	-27.9954	0.0105	0	0.02125	0	0.032	55.1589	0.04275	0
0.000025	-27.9954	0.01075	27.7181	0.0215	0	0.03225	55.1589	0.043	27.7181
0.00005	109.209	0.011	82.3224	0.02175	-27.9954	0.0325	55.1589		
0.000075	188.203	0.01125	109.209	0.022	27.7181	0.03275	27.7181		
0.0001	326.09	0.0115	0	0.02225	0	0.033	55.1589		
0.000125	538.454	0.01175	55.1589	0.0225	0	0.03325	55.1589		
0.00015	959.849	0.012	27.7181	0.02275	-27.9954	0.0335	55.1589		
0.000175	1129.39	0.01225	0	0.023	0	0.03375	27.7181		
0.0002	1129.39	0.0125	0	0.02325	27.7181	0.034	27.7181		
0.000225	1086.5	0.01275	-27.9954	0.0235	27.7181	0.03425	27.7181		
0.00025	1001.68	0.013	-113.645	0.02375	0	0.0345	27.7181		
0.000275	918.455	0.01325	0	0.024	0	0.03475	0		
0.0003	877.543	0.0135	27.7181	0.02425	0	0.035	27.7181		

Gauge22_2 Time msec	Gauge22_2 Stress MPa	Gauge22_2 Time msec	Gauge22_2 Stress MPa	Gauge22_2 Time msec	Gauge22_2 Stress MPa	Gauge22_2 Time msec	Gauge22_2 Stress MPa	Gauge22_2 Time msec	Gauge22_2 Stress MPa
0.0445	-0.35508	0.05525	-1.42059	0.066	-21.7417	0.07675	-23.8892	0.0875	-22.0995
0.04475	0	0.0555	-1.06538	0.06625	-21.384	0.077	-22.4574	0.08775	-22.4574
0.045	-0.35508	0.05575	-0.710206	0.0665	-20.3109	0.07725	-23.1732	0.088	-22.4574
0.04525	0	0.056	-0.35508	0.06675	-19.5958	0.0775	-22.0995	0.08825	-22.8153
0.0455	0	0.05625	0.710027	0.067	-18.5235	0.07775	-21.0262	0.0885	-22.8153
0.04575	0	0.0565	2.12954	0.06725	-16.7371	0.078	-18.8809	0.08875	-22.8153
0.046	0	0.05675	5.32084	0.0675	-14.2381	0.07825	-18.1661	0.089	-22.0995
0.04625	0	0.057	9.9241	0.06775	-12.4544	0.0785	-19.9534	0.08925	-22.4574
0.0465	0	0.05725	14.5198	0.068	-10.6719	0.07875	-21.384	0.0895	-23.5312
0.04675	0	0.0575	17.697	0.06825	-9.60286	0.079	-22.4574	0.08975	-25.3218
0.047	0	0.05775	21.223	0.0685	-9.95915	0.07925	-22.4574	0.09	-24.6054
0.04725	0	0.058	22.6322	0.06875	-9.95915	0.0795	-21.384	0.09025	-23.8892
0.0475	0	0.05825	20.5182	0.069	-9.95915	0.07975	-21.7417	0.0905	-22.4574
0.04775	0	0.0585	14.873	0.06925	-9.95915	0.08	-20.6686	0.09075	-23.5312
0.048	0	0.05875	7.44636	0.0695	-10.6719	0.08025	-19.9534	0.091	-26.7551
0.04825	-0.35508	0.059	2.12954	0.06975	-11.0283	0.0805	-18.1661	0.09125	-26.7551
0.0485	0	0.05925	-2.8419	0.07	-12.8111	0.08075	-17.8088	0.0915	-26.7551
0.04875	-0.35508	0.0595	-8.89042	0.07025	-14.2381	0.081	-18.1661	0.09175	-27.472
0.049	0	0.05975	-15.3088	0.0705	-16.7371	0.08125	-19.5958	0.092	-28.1891
0.04925	0	0.06	-18.1661	0.07075	-18.8809	0.0815	-22.4574	0.09225	-28.9064
0.0495	-0.35508	0.06025	-17.8088	0.071	-21.7417	0.08175	-22.0995	0.0925	-28.9064
0.04975	-0.35508	0.0605	-19.2383	0.07125	-23.5312	0.082	-19.2383	0.09275	-29.6238
0.05	-0.35508	0.06075	-20.6686	0.0715	-24.9636	0.08225	-21.384	0.093	-29.6238
0.05025	-0.35508	0.061	-20.3109	0.07175	-26.0384	0.0825	-21.7417	0.09325	-29.6238
0.0505	-0.710206	0.06125	-18.5235	0.072	-26.3967	0.08275	-21.7417	0.0935	-29.2651
0.05075	-0.710206	0.0615	-16.7371	0.07225	-25.3218	0.083	-23.8892	0.09375	-30.3414
0.051	-0.710206	0.06175	-14.595	0.0725	-25.3218	0.08325	-24.6054	0.094	-30.7003
0.05125	-1.06538	0.062	-13.1678	0.07275	-24.9636	0.0835	-23.5312	0.09425	-29.9826
0.0515	-1.06538	0.06225	-12.4544	0.073	-25.6801	0.08375	-21.384	0.0945	-28.9064
0.05175	-1.06538	0.0625	-12.8111	0.07325	-27.8305	0.084	-21.384	0.09475	-27.8305
0.052	-1.06538	0.06275	-12.8111	0.0735	-28.5477	0.08425	-22.0995	0.095	-27.1135
0.05225	-1.06538	0.063	-14.2381	0.07375	-29.2651	0.0845	-22.4574	0.09525	-27.1135
0.0525	-1.42059	0.06325	-16.0229	0.074	-29.9826	0.08475	-22.0995	0.0955	-26.3967
0.05275	-1.42059	0.0635	-18.1661	0.07425	-29.2651	0.085	-21.7417	0.09575	-24.9636
0.053	-1.42059	0.06375	-19.9534	0.0745	-28.5477	0.08525	-21.7417	0.096	-23.5312
0.05325	-1.42059	0.064	-21.384	0.07475	-29.2651	0.0855	-22.4574	0.09625	-25.3218
0.0535	-1.42059	0.06425	-22.4574	0.075	-29.6238	0.08575	-22.4574	0.0965	-26.7551
0.05375	-1.42059	0.0645	-22.0995	0.07525	-31.4182	0.086	-22.4574	0.09675	-26.0384
0.054	-1.42059	0.06475	-22.8153	0.0755	-32.1363	0.08625	-22.4574	0.097	-26.0384
0.05425	-1.42059	0.065	-22.4574	0.07575	-31.7772	0.0865	-21.7417	0.09725	-24.9636
0.0545	-1.42059	0.06525	-22.4574	0.076	-29.6238	0.08675	-21.7417	0.0975	-25.3218
0.05475	-1.42059	0.0655	-22.0995	0.07625	-28.1891	0.087	-22.0995	0.09775	-26.3967
0.055	-1.42059	0.06575	-26.0384	0.0765	-21.7417	0.088	-27.472		

Gauge22_2 Time msec	Gauge22_2 Stress MPa	Gauge22_3 Time msec	Gauge22_3 Stress MPa	Gauge22_3 Time msec	Gauge22_3 Stress MPa	Gauge22_4 Time msec	Gauge22_4 Stress MPa	Gauge22_4 Time msec	Gauge22_4 Stress MPa
0.09825	-27.472	0.04575	-0.353055	0.06725	22.1529	0.04575	1.0589	0.0565	1.0589
0.0985	-29.9826	0.04625	-0.353055	0.06775	24.2535	0.046	1.0589	0.05675	1.0589
0.09875	-29.2651	0.04675	-0.353055	0.06825	26.3524	0.04625	1.0589	0.057	1.0589
0.099	-28.5477	0.04725	-0.353055	0.06875	27.0518	0.0465	1.0589	0.05725	1.0589
0.09925	-27.8305	0.04775	-0.353055	0.06925	27.0518	0.04675	1.41178	0.0575	1.0589
0.0995	-27.472	0.04825	-0.353055	0.06975	27.0518	0.047	1.0589	0.05775	1.0589
0.09975	-27.8305	0.04875	0	0.07025	24.9533	0.04725	1.0589	0.058	0.705977
0.1	-28.1891	0.04925	0	0.07075	22.1529	0.0475	1.0589	0.05825	0.705977
0.10025	-29.2651	0.04975	0	0.07125	23.5534	0.04775	1.0589	0.0585	1.0589
0.1005	-29.6238	0.05025	-0.353055	0.07175	24.6034	0.048	1.0589	0.05875	1.41178
0.10075	-30.3414	0.05075	0.353011	0.07225	24.9533	0.04825	1.0589	0.059	1.0589
0.101	-30.7003	0.05125	-0.353055	0.07275	23.5534	0.0485	1.0589	0.05925	1.41178
0.10125	-32.1363	0.05175	-1.0593	0.07325	21.102	0.04875	1.41178	0.0595	1.41178
0.1015	-32.1363	0.05225	-1.0593	0.07375	20.0507	0.049	1.0589	0.05975	1.41178
0.10175	-32.1363	0.05275	-1.41249	0.07425	20.7516	0.04925	1.41178	0.06	1.0589
0.102	-31.4136	0.05325	-1.41249	0.07475	22.5031	0.0495	1.0589	0.06025	0.705977
0.10225	-31.4091	0.05375	-1.76572	0.07525	24.2535	0.04975	1.0589	0.0605	1.0589
0.1025	-32.1225	0.05425	-1.76572	0.07575	25.653	0.05	1.41178	0.06075	1.0589
0.10275	-32.118	0.05475	-2.119	0.07625	28.7993	0.05025	1.0589	0.061	1.41178
0.103	-32.1134	0.05525	-2.119	0.07675	32.2909	0.0505	1.0589	0.06125	1.41178
0.10325	-32.1088	0.05575	-1.76572	0.07725	33.3375	0.05075	1.0589	0.0615	1.0589
0.1035	-32.1042	0.05625	0	0.07775	31.9419	0.051	1.41178	0.06175	1.41178
		0.05675	7.75597	0.07825	32.6398	0.05125	1.0589	0.062	1.41178
		0.05725	16.8944	0.07875	30.5456	0.0515	1.0589	0.06225	1.0589
		0.05775	39.9569	0.07925	28.7993	0.05175	1.0589	0.0625	1.41178
		0.05825	57.6453	0.07975	26.3524	0.052	0.705977	0.06275	1.0589
		0.05875	57.2996	0.08025	24.9533	0.05225	0.705977	0.063	1.41178
		0.05925	39.6089	0.08075	21.4523	0.0525	1.0589	0.06325	1.76461
		0.05975	32.2909	0.08125	20.4011	0.05275	1.0589	0.0635	1.0589
		0.06025	26.3524	0.08175	20.0507	0.053	1.41178	0.06375	1.76461
		0.06075	28.7993	0.08225	18.6483	0.05325	1.0589	0.064	1.41178
		0.06125	32.2909	0.08275	18.999	0.0535	0.705977	0.06425	1.0589
		0.06175	37.1718			0.05375	0.705977	0.0645	1.0589
		0.06225	42.0439			0.054	1.0589	0.06475	1.0589
		0.06275	44.4767			0.05425	1.0589	0.065	1.76461
		0.06325	45.1714			0.0545	1.0589	0.06525	1.41178
		0.06375	41.0006			0.05475	0.705977	0.0655	1.41178
		0.06425	34.3838			0.055	1.0589	0.06575	1.41178
		0.06475	26.3524			0.05525	1.0589	0.066	1.41178
		0.06525	21.4523			0.0555	1.0589	0.06625	1.41178
		0.06575	19.3496			0.05575	1.0589	0.0665	1.0589
		0.06625	20.0507			0.056	1.0589	0.06675	1.41178
		0.06675	21.4523			0.05625	0.705977	0.067	1.0589

Gauge22_4 Time msec	Gauge22_4 Stress MPa	Gauge22_4 Time msec	Gauge22_4 Stress MPa	Gauge22_4 Time msec	Gauge22_4 Stress MPa	Gauge22_4 Time msec	Gauge22_4 Stress MPa	Gauge22_5 Time msec	Gauge22_5 Stress MPa
0.06725	1.0589	0.078	1.0589	0.08875	1.76461	0.0995	0	-0.175853	0.09175
0.0675	1.41178	0.07825	1.41178	0.089	1.76461	0.09975	0	-0.175853	0.09225
0.06775	1.41178	0.0785	1.41178	0.08925	1.41178	0.1	-0.353055	-0.175853	0.09275
0.068	1.0589	0.07875	1.41178	0.0895	1.0589	0.10025	-0.353055	-0.175853	0.09325
0.06825	1.76461	0.079	1.41178	0.08975	0.705977	0.1005	-0.353055	-0.175853	0.09375
0.0685	1.76461	0.07925	1.41178	0.09	0.705977	0.10075	-0.353055	0	0.09425
0.06875	1.41178	0.0795	1.0589	0.09025	0.705977	0.101	-0.353055	0	0.09475
0.069	1.76461	0.07975	1.0589	0.0905	0.705977	0.10125	-1.0593	1.5494E-13	0.09525
0.06925	1.76461	0.08	1.0589	0.09075	0.705977	0.1015	-0.353055	0.175842	0.09575
0.0695	1.41178	0.08025	1.41178	0.091	0.705977	0.10175	-0.706155	0	0.09625
0.06975	1.76461	0.0805	-1.41249	0.09125	0.705977	0.102	-0.706155	-0.175853	0.09675
0.07	1.76461	0.08075	-5.3005	0.0915	0.353011	0.10225	-0.706155	0	0.09725
0.07025	1.0589	0.081	-1.0593	0.09175	0	0.1025	-0.353055	0.175842	0.09775
0.0705	1.76461	0.08125	0.353011	0.092	-1.41249	0.10275	1.0589	0.175842	0.09825
0.07075	1.76461	0.0815	0.353011	0.09225	-1.41249	0.103	0	0	0.09875
0.071	1.41178	0.08175	0.353011	0.0925	-0.353055	0.10325	2.1174	0	0.09925
0.07125	1.41178	0.082	1.0589	0.09275	0.353011	0.1035	0.705977	0	0.09975
0.0715	1.41178	0.08225	1.0589	0.093	0.353011	0.10375	0	0	0.10025
0.07175	1.41178	0.0825	1.0589	0.09325	0.353011	0.104	0.353011	0	0.10075
0.072	1.76461	0.08275	0.705977	0.0935	0.353011	0.10425	1.0589	0.175842	0.10125
0.07225	1.41178	0.083	1.0589	0.09375	0.705977	0.1045	1.41178	0.175842	0.10175
0.0725	1.76461	0.08325	1.41178	0.094	1.0589	0.10475	0.705977	0	0.10225
0.07275	2.47014	0.0835	1.41178	0.09425	1.0589	0.105	0.353011	0.175842	0.10275
0.073	1.76461	0.08375	2.82284	0.0945	1.0589	0.10525	0.353011	-0.175853	0.10325
0.07325	2.1174	0.084	1.76461	0.09475	0.353011	0.1055	0.353011	0	0.10375
0.0735	1.0589	0.08425	1.76461	0.095	0.705977	0.10575	0.353011	0	0.10425
0.07375	1.0589	0.0845	1.41178	0.09525	0.705977	0.106	1.41178	0.175842	0.10475
0.074	1.41178	0.08475	1.41178	0.0955	1.0589	0.10625	0.705977	0	0.10525
0.07425	1.41178	0.085	2.47014	0.09575	0.705977	0.1065	0.353011	0.527494	0.10575
0.0745	1.41178	0.08525	2.1174	0.096	0.353011	0.10675	-6.271E-13	0.175842	0.10625
0.07475	1.0589	0.0855	1.76461	0.09625	0	0.107	0	0	0.10675
0.075	2.1174	0.08575	1.76461	0.0965	0.353011	0.10725	0.353011	0.351674	0.10725
0.07525	2.1174	0.086	1.76461	0.09675	0.353011	0.1075	0.705977	0.703303	0.10775
0.0755	1.76461	0.08625	1.41178	0.097	0.353011	0.10775	1.76461	0.879101	0.10825
0.07575	0.705977	0.0865	1.76461	0.09725	0.705977	0.108	3.52811	1.93366	0.10875
0.076	0.705977	0.08675	1.41178	0.0975	0.705977	0.10825	4.58567	3.69036	0.10925
0.07625	1.0589	0.087	1.76461	0.09775	0.353011	0.1085	5.99514	4.04157	0.10975
0.0765	1.76461	0.08725	1.76461	0.098	-0.353055	0.10875	9.8675	1.05489	0.11025
0.07675	1.41178	0.0875	1.76461	0.09825	0	0.109	10.9227	-2.46296	0.11075
0.077	1.41178	0.08775	1.0589	0.0985	1.0589	0.10925	12.6804	-6.69021	0.11125
0.07725	1.76461	0.088	1.0589	0.09875	0.353011	0.1095	13.3832		
0.0775	1.76461	0.08825	1.41178	0.099	0.353011	0.10975	10.571		
0.07775	1.41178	0.0885	1.41178	0.09925	0	0.11	3.52811		

Gauge22_6	Gauge22_6	Gauge22_6	Gauge22_6	Gauge22_6	Gauge22_6	Gauge22_6	Gauge22_6	Gauge22_6	Gauge22_6
Time	Stress	Time	Stress	Time	Stress	Time	Stress	Time	Stress
msec	MPa	msec	MPa	msec	MPa	msec	MPa	msec	MPa
0.09125	0.177185	0.11275	-0.886091	0.13425	-1.2406	0.15575	0.885812	0.17725	0.708672
0.09175	0	0.11325	-1.06334	0.13475	-1.41788	0.15625	1.06294	0.17775	3.01062
0.09225	0	0.11375	-0.886091	0.13525	-1.41788	0.15675	1.24006	0.17825	8.66893
0.09275	0.177185	0.11425	-0.886091	0.13575	-1.2406	0.15725	1.41716	0.17875	17.3111
0.09325	0	0.11475	-1.06334	0.13625	-1.2406	0.15775	1.41716	0.17925	23.6433
0.09375	0.177185	0.11525	-1.06334	0.13675	-1.41788	0.15825	1.59426	0.17975	20.479
0.09425	0.177185	0.11575	-1.2406	0.13725	-1.2406	0.15875	1.77134	0.18025	7.25542
0.09475	0	0.11625	-1.2406	0.13775	-1.41788	0.15925	1.59426	0.18075	-4.43324
0.09525	0.177185	0.11675	-1.2406	0.13825	-1.41788	0.15975	1.59426	0.18125	-6.9189
0.09575	0.177185	0.11725	-1.41788	0.13875	-1.41788	0.16025	1.41716	0.18175	-8.87346
0.09625	0.177185	0.11775	-1.41788	0.13925	-1.2406	0.16075	1.24006	0.18225	-10.2958
0.09675	0	0.11825	-1.41788	0.13975	-1.06334	0.16125	1.41716	0.18275	-11.1851
0.09725	0.177185	0.11875	-1.41788	0.14025	-1.2406	0.16175	1.06294	0.18325	-10.6515
0.09775	0.177185	0.11925	-1.77246	0.14075	-1.2406	0.16225	1.41716	0.18375	-12.7866
0.09825	0	0.11975	-1.77246	0.14125	-1.06334	0.16275	1.06294	0.18425	-11.5409
0.09875	0	0.12025	-1.77246	0.14175	-1.2406	0.16325	1.06294	0.18475	-13.4987
0.09925	1.5612E-13	0.12075	-1.59516	0.14225	-1.06334	0.16375	0.708672	0.18525	-13.4987
0.09975	0.177185	0.12125	-1.2406	0.14275	-1.06334	0.16425	1.06294	0.18575	-13.4987
0.10025	-1.94977	0.12175	-1.41788	0.14325	-1.2406	0.16475	1.24006	0.18625	-13.4987
0.10075	-0.177196	0.12225	-1.06334	0.14375	-1.06334	0.16525	1.06294	0.18675	-13.4987
0.10125	0.177185	0.12275	-1.2406	0.14425	-1.06334	0.16575	1.06294	0.18725	-13.4987
0.10175	-1.06334	0.12325	-1.2406	0.14475	-1.06334	0.16625	0.885812	0.18775	-13.6767
0.10225	0.177185	0.12375	-1.2406	0.14525	-1.06334	0.16675	1.06294	0.18825	-13.6767
0.10275	0.177185	0.12425	-1.2406	0.14575	-0.886091	0.16725	0.885812	0.18875	-13.6767
0.10325	3.54157	0.12475	-1.2406	0.14625	-0.886091	0.16775	0.354358	0.18925	-13.6767
0.10375	0	0.12525	-1.41788	0.14675	-0.886091	0.16825	0.885812		
0.10425	0	0.12575	-1.2406	0.14725	-0.886091	0.16875	0.885812		
0.10475	0.354358	0.12625	-1.2406	0.14775	-0.886091	0.16925	0.53152		
0.10525	0.53152	0.12675	-1.41788	0.14825	-0.886091	0.16975	0.177185		
0.10575	0.177185	0.12725	-1.06334	0.14875	-0.886091	0.17025	-0.354403		
0.10625	0.354358	0.12775	-1.2406	0.14925	-0.70885	0.17075	-0.354403		
0.10675	0.177185	0.12825	-0.886091	0.14975	-0.531621	0.17125	-0.531621		
0.10725	0.177185	0.12875	-1.06334	0.15025	-0.531621	0.17175	-0.70885		
0.10775	0.354358	0.12925	-1.06334	0.15075	-0.531621	0.17225	-1.06334		
0.10825	0.177185	0.12975	-1.2406	0.15125	-0.177196	0.17275	-1.06334		
0.10875	0	0.13025	-1.06334	0.15175	-0.177196	0.17325	-0.70885		
0.10925	0.177185	0.13075	-2.83647	0.15225	-0.177196	0.17375	-0.70885		
0.10975	0.177185	0.13125	-1.41788	0.15275	0.177185	0.17425	-1.06334		
0.11025	-0.177196	0.13175	-1.06334	0.15325	0.354358	0.17475	-1.2406		
0.11075	-0.177196	0.13225	-1.41788	0.15375	0.354358	0.17525	-1.41788		
0.11125	-0.354403	0.13275	-1.77246	0.15425	0.354358	0.17575	-1.06334		
0.11175	-0.354403	0.13325	-1.41788	0.15475	0.354358	0.17625	-0.177196		
0.11225	-0.531621	0.13375	-1.2406	0.15525	0.708672	0.17675	0.177185		

Gauge23_1	Gauge23_1	Gauge23_1	Gauge23_1	Gauge23_1	Gauge23_1	Gauge23_2	Gauge23_2	Gauge23_2	Gauge23_2
Time	Stress	Time	Stress	Time	Stress	Time	Stress	Time	Stress
msec	MPa	msec	MPa	msec	MPa	msec	MPa	msec	MPa
-0.01775	-28.7035	-0.007	0	0.00375	666.978	0.03725	-0.356443	0.048	-0.712932
-0.0175	0	-0.00675	28.4191	0.004	520.706	0.03775	-0.712932	0.04825	-1.06947
-0.01725	0	-0.0065	28.4191	0.00425	391.246	0.03775	-0.356443	0.0485	-0.712932
-0.017	0	-0.00625	56.554	0.0045	219.392	0.038	-0.712932	0.04875	-0.712932
-0.01675	0	-0.006	28.4191	0.00475	139.252	0.03825	0.049	0.049	-0.356443
-0.0165	0	-0.00575	0	0.005	111.971	0.0385	-0.712932	0.04925	0
-0.01625	-28.7035	-0.0055	28.4191	0.00525	84.4044	0.03875	-0.356443	0.0495	0
-0.016	0	-0.00525	28.4191	0.0055	84.4044	0.039	-0.712932	0.04975	-0.356443
-0.01575	0	-0.005	0	0.00575	56.554	0.03925	-0.712932	0.05	-0.356443
-0.0155	0	-0.00475	0	0.006	84.4044	0.0395	-0.356443	0.05025	-0.356443
-0.01525	0	-0.0045	0	0.00625	56.554	0.03975	-0.356443	0.0505	-0.712932
-0.015	-28.7035	-0.00425	28.4191	0.0065	56.554	0.04	-0.356443	0.05075	-0.712932
-0.01475	-28.7035	-0.004	0	0.00675	28.4191	0.04025	-0.712932	0.051	-0.356443
-0.0145	28.4191	-0.00375	0	0.007	28.4191	0.0405	-0.356443	0.05125	-0.712932
-0.01425	-28.7035	-0.0035	0	0.00725	56.554	0.04075	-0.356443	0.0515	-0.356443
-0.014	-28.7035	-0.00325	28.4191	0.0075	84.4044	0.041	-0.356443	0.05175	-0.356443
-0.01375	28.4191	-0.003	0	0.00775	139.252	0.04125	-0.356443	0.052	-0.356443
-0.0135	-28.7035	-0.00275	0	0.008	111.971	0.0415	-0.356443	0.05225	-0.356443
-0.01325	-28.7035	-0.0025	0	0.00825	139.252	0.04175	-0.356443	0.0525	-0.356443
-0.013	0	-0.00225	0	0.0085	56.554	0.042	-0.356443	0.05275	-0.356443
-0.01275	-28.7035	-0.002	0	0.00875	56.554	0.04225	0.356399	0.053	-0.356443
-0.0125	-28.7035	-0.00175	0	0.009	84.4044	0.0425	-1.06947	0.05325	0
-0.01225	0	-0.0015	0	0.00925	111.971	0.04275	-0.356443	0.0535	-0.712932
-0.012	0	-0.00125	0	0.0095	111.971	0.043	-0.712932	0.05375	-0.356443
-0.01175	-28.7035	-0.001	0	0.00975	139.252	0.04325	0	0.054	-0.356443
-0.0115	28.4191	-0.00075	0	0.01	111.971	0.0435	-0.712932	0.05425	0
-0.01125	0	-0.0005	28.4191	0.01025	56.554	0.04375	-0.712932	0.0545	-0.712932
-0.011	-28.7035	-0.00025	0	0.0105	-57.6912	0.044	-0.356443	0.05475	0
-0.01075	0	0	0	0.01075	28.4191	0.04425	-0.356443	0.055	-0.356443
-0.0105	28.4191	0.00025	28.4191	0.011	-28.7035	0.0445	-0.356443	0.05525	-0.356443
-0.01025	-28.7035	0.0005	84.4044			0.04475	-0.356443	0.0555	-0.356443
-0.01	-28.7035	0.00075	192.963			0.045	-0.356443	0.05575	0
-0.00975	28.4191	0.001	333.894			0.04525	-0.356443	0.056	-0.356443
-0.0095	0	0.00125	520.706			0.0455	-0.712932	0.05625	-0.356443
-0.00925	-28.7035	0.0015	953.61			0.04575	-0.712932	0.0565	0.356399
-0.009	0	0.00175	1174.59			0.046	-0.712932	0.05675	-1.06947
-0.00875	0	0.002	1174.59			0.04625	-0.356443	0.057	0.356399
-0.0085	-28.7035	0.00225	1129.65			0.0465	0	0.05725	-0.712932
-0.00825	0	0.0025	1085.03			0.04675	0	0.0575	-0.712932
-0.008	-28.7035	0.00275	996.969			0.047	0	0.05775	-0.356443
-0.00775	-28.7035	0.003	996.969			0.04725	0	0.058	-0.356443
-0.0075	0	0.00325	996.969			0.0475	-0.712932	0.05825	-0.356443
-0.00725	-28.7035	0.0035	868.467			0.04775	-1.06947	0.0585	0

Gauge23_2 Time msec	Gauge23_2 Stress MPa	Gauge23_2 Time msec	Gauge23_2 Stress MPa	Gauge23_3 Time msec	Gauge23_3 Stress MPa	Gauge23_3 Time msec	Gauge23_3 Stress MPa	Gauge23_4 Time msec	Gauge23_4 Stress MPa
0.05875	-0.356443	0.0695	17.0565	0.04225	0	0.06375	2.48907	0.09725	0.714123
0.059	-0.356443	0.06975	17.765	0.04275	0	0.06425	3.91041	0.0975	0.357084
0.05925	-0.356443	0.07	18.1191	0.04325	0.355716	0.06475	6.04108	0.09775	0.357084
0.0595	0	0.07025	14.9301	0.04375	0.355716	0.06525	8.87946	0.098	0.714123
0.05975	-0.356443	0.0705	6.40831	0.04425	0	0.06575	9.58861	0.09825	1.07112
0.06	0	0.07075	-10	0.04475	0	0.06625	13.1317	0.0985	0.714123
0.06025	-0.356443			0.04525	0.355716	0.06675	12.0692	0.09875	0.357084
0.0605	-0.356443			0.04575	-0.355761	0.06725	6.04108	0.099	0.714123
0.06075	0			0.04625	0.355716	0.06775	-2.84734	0.09925	0.357084
0.061	0			0.04675	0.355716	0.06825	-11.0494	0.0995	0.714123
0.06125	0			0.04725	0.355716			0.09975	0.357084
0.0615	0			0.04775	0.355716			0.1	0.357084
0.06175	0			0.04825	0			0.10025	0.714123
0.062	-0.356443			0.04875	0.355716			0.1005	0.357084
0.06225	0			0.04925	0			0.10075	0.714123
0.0625	-0.356443			0.04975	0.355716			0.101	0.357084
0.06275	0			0.05025	0			0.10125	1.07112
0.063	-0.356443			0.05075	0			0.1015	0.357084
0.06325	-0.356443			0.05125	0			0.10175	0.357084
0.0635	0			0.05175	0.711387			0.102	0.357084
0.06375	0			0.05225	0			0.10225	0.357084
0.064	0			0.05275	0			0.1025	0.357084
0.06425	0			0.05325	0			0.10275	0.357084
0.0645	0			0.05375	0.355716			0.103	0.714123
0.06475	0			0.05425	3.1343E-13			0.10325	0.714123
0.065	-0.356443			0.05475	0			0.1035	0.714123
0.06525	-0.356443			0.05525	0			0.10375	0.714123
0.0655	-0.356443			0.05575	0.355716			0.104	0.714123
0.06575	0			0.05625	0			0.10425	0.714123
0.066	0			0.05675	0			0.1045	0.714123
0.06625	0			0.05725	0.355716			0.10475	0.714123
0.0665	0.356399			0.05775	3.1343E-13			0.105	0.714123
0.06675	0.356399			0.05825	0.355716			0.10525	0.357084
0.067	0.356399			0.05875	0			0.1055	0.357084
0.06725	-0.356443			0.05925	0.355716			0.10575	0.357084
0.0675	-0.356443			0.05975	0			0.106	0.357084
0.06775	0			0.06025	0			0.10625	0.357084
0.068	0			0.06075	0			0.1065	0.357084
0.06825	0			0.06125	0			0.10675	0.357084
0.0685	1.06906			0.06175	0.355716			0.107	0.357084
0.06875	3.20597			0.06225	0			0.10725	0.714123
0.069	6.7639			0.06275	0.355716			0.1075	0.714123
0.06925	11.3825			0.06325	1.06701			0.10775	0.714123
Gauge23_4 Time msec	Gauge23_4 Stress MPa	Gauge23_4 Time msec	Gauge23_4 Stress MPa	Gauge23_4 Time msec	Gauge23_4 Stress MPa	Gauge23_5 Time msec	Gauge23_5 Stress MPa	Gauge23_5 Time msec	Gauge23_5 Stress MPa
0.108	0	0.11875	0.357084	0.1295	0.714123	0.10225	1.5612E-13	0.12375	-0.177196
0.10825	0	0.119	0.357084	0.12975	0.714123	0.10275	0.53152	0.12425	-1.2406
0.1085	0	0.11925	0.357084	0.13	0.357084	0.10325	0.354358	0.12475	0.177185
0.10875	0.357084	0.1195	0.357084	0.13025	0	0.10375	0.177185	0.12525	1.5612E-13
0.109	0	0.11975	1.07112	0.1305	-5.36166	0.10425	0.354358	0.12575	0.354358
0.10925	0.357084	0.12	0.714123	0.13075	-2.50085	0.10475	0.177185	0.12625	0.354358
0.1095	0.357084	0.12025	0.357084	0.131	-0.357129	0.10525	0.354358	0.12675	0.53152
0.10975	0.357084	0.1205	0.357084	0.13125	0.714123	0.10575	0.53152	0.12725	0.177185
0.11	0.357084	0.12075	0.357084	0.1315	0.714123	0.10625	0	0.12775	0.177185
0.11025	0.357084	0.121	0.714123	0.13175	0	0.10675	0.354358	0.12825	0
0.1105	0.357084	0.12125	0	0.132	0.714123	0.10725	0.708672	0.12875	0.177185
0.11075	0.357084	0.1215	0	0.13225	0.357084	0.10775	0.177185	0.12925	0.177185
0.111	0.357084	0.12175	0	0.1325	0.714123	0.10825	0.177185	0.12975	0.177185
0.11125	0.357084	0.122	0	0.13275	0.714123	0.10875	0.177185	0.13025	0.708672
0.1115	0.357084	0.12225	0	0.133	0.714123	0.10925	0.354358	0.13075	0.53152
0.11175	0.357084	0.1225	0	0.13325	0.357084	0.10975	0.354358	0.13125	0.354358
0.112	0.357084	0.12275	-0.714303	0.1335	0.714123	0.11025	0.53152	0.13175	0.354358
0.11225	0.357084	0.123	-4.64618	0.13375	1.07112	0.11075	0.53152	0.13225	0.354358
0.1125	0.714123	0.12325	-4.64618	0.134	0.357084	0.11125	0.53152	0.13275	-0.531621
0.11275	0.357084	0.1235	-1.07152	0.13425	0	0.11175	0.708672	0.13325	1.41716
0.113	0.357084	0.12375	0	0.1345	-0.357129	0.11225	0.354358	0.13375	2.47957
0.11325	0.357084	0.124	0	0.13475	-0.714303	0.11275	0.53152	0.13425	3.71854
0.1135	0	0.12425	0	0.135	-1.42879	0.11325	0.53152	0.13475	6.5484
0.11375	0.357084	0.1245	0	0.13525	-3.57331	0.11375	0.177185	0.13525	7.43215
0.114	0.357084	0.12475	0	0.1355	-3.57331	0.11425	0.177185	0.13575	3.01062
0.11425	0.357084	0.125	0	0.13575	-2.50085	0.11475	-0.177196	0.13625	-5.49826
0.1145	0	0.12525	-0.357129	0.136	-3.57331	0.11525	-0.354403	0.13675	-10.8294
0.11475	0	0.1255	0	0.13625	-2.50085	0.11575	-0.354403		
0.115	0.357084	0.12575	0	0.1365	-3.21578	0.11625	-0.354403		
0.11525	0	0.126	0	0.13675	-6.07731	0.11675	1.7134		
0.1155	0	0.12625	0.357084	0.137	-9.65827	0.11725	0.177185		
0.11575	0.357084	0.1265	0.714123	0.13725	-10.0166	0.11775	1.5612E-13		
0.116	0.357084	0.12675	0.357084	0.1375	-10.375	0.11825	2.30253		
0.11625	0	0.127	0.357084	0.13775	-10.0166	0.11875	1.59426		
0.1165	0	0.12725	0.714123	0.138	-10.375	0.11925	1.77134		
0.11675	0	0.1275	1.07112	0.13825	-8.58351	0.11975	2.6566		
0.117	0	0.12775	0.714123			0.12025	3.01062		
0.11725	0	0.128	0			0.12075	2.6566		
0.1175	0	0.12825	0			0.12125	1.5612E-13		
0.11775	0	0.1285	-0.357129			0.12175	-0.531621		
0.118	0	0.12875	0.357084			0.12225	-0.70885		
0.11825	0.357084	0.129	0			0.12275	-1.06334		
0.1185	0.357084	0.12925	0			0.12325	-1.06334		

Gauge23_6 Time msec	Gauge23_6 Stress MPa	Gauge23_6 Time msec	Gauge23_6 Stress MPa	Gauge23_6 Time msec	Gauge23_6 Stress MPa	Gauge23_6 Time msec	Gauge23_6 Stress MPa	Gauge23_6 Time msec	Gauge23_6 Stress MPa
0.05525	0	0.07675	0.178548	0.09825	0.535609	0.11975	-1.07152	0.14125	1.2496
0.05575	0	0.07725	0	0.09875	0.535609	0.12025	-0.53571	0.14175	0.535609
0.05625	0	0.07775	0.178548	0.09925	0.357084	0.12075	-0.714303	0.14225	1.07112
0.05675	0	0.07825	0.178548	0.09975	0.535609	0.12125	-0.714303	0.14275	2.14183
0.05725	0	0.07875	0.714123	0.10025	0.535609	0.12175	3.21214	0.14325	-0.178559
0.05775	0.178548	0.07925	1.07112	0.10075	0.714123	0.12225	0.357084	0.14375	0.178548
0.05825	0.178548	0.07975	1.42807	0.10125	0.714123	0.12275	0.357084	0.14425	-0.178559
0.05875	0	0.08025	1.42807	0.10175	0.714123	0.12325	6.42063	0.14475	-0.53571
0.05925	-0.178559	0.08075	1.07112	0.10225	4.10375	0.12375	0.535609	0.14525	-0.892907
0.05975	-0.178559	0.08125	0.535609	0.10275	0.714123	0.12425	-1.07152	0.14575	0
0.06025	-0.178559	0.08175	1.96341	0.10325	0.357084	0.12475	0.535609	0.14625	-0.892907
0.06075	-0.178559	0.08225	1.07112	0.10375	0.357084	0.12525	1.07112	0.14675	-1.42879
0.06125	0	0.08275	0.178548	0.10425	0.178548	0.12575	1.07112	0.14725	3.47414
0.06175	0	0.08325	0.357084	0.10475	-1.60743	0.12625	8.02351	0.14775	-2.32214
0.06225	0	0.08375	1.60652	0.10525	0.178548	0.12675	-8.04628	0.14825	-6.4352
0.06275	0	0.08425	0.535609	0.10575	1.07112	0.12725	-1.25015	0.14875	-3.7521
0.06325	0	0.08475	1.07112	0.10625	0	0.12775	1.2496	0.14925	-3.7521
0.06375	0	0.08525	1.07112	0.10675	-0.178559	0.12825	-2.14345	0.14975	-4.82503
0.06425	-0.178559	0.08575	1.07112	0.10725	-0.714303	0.12875	1.96341	0.15025	-5.18277
0.06475	0.357084	0.08625	1.07112	0.10775	0	0.12925	0.714123	0.15075	-5.71946
0.06525	0.178548	0.08675	0.535609	0.10825	0	0.12975	0.357084	0.15125	-5.0039
0.06575	0	0.08725	0.357084	0.10875	-0.714303	0.13025	0.892626	0.15175	-7.50915
0.06625	0	0.08775	0.178548	0.10925	0.535609	0.13075	0.535609	0.15225	-8.58351
0.06675	0	0.08825	0.892626	0.10975	0.535609	0.13125	0	0.15275	-10.1958
0.06725	0	0.08875	0.357084	0.11025	0.892626	0.13175	0.714123		
0.06775	0.178548	0.08925	0.178548	0.11075	-1.573E-13	0.13225	0.535609		
0.06825	0.178548	0.08975	0.178548	0.11125	-1.07152	0.13275	0.714123		
0.06875	0	0.09025	0.357084	0.11175	0	0.13325	1.42807		
0.06925	0	0.09075	0.357084	0.11225	0	0.13375	1.07112		
0.06975	0.178548	0.09125	-1.96477	0.11275	0.178548	0.13425	1.60652		
0.07025	0	0.09175	0	0.11325	0.178548	0.13475	3.03378		
0.07075	0	0.09225	-0.178559	0.11375	-0.178559	0.13525	2.67703		
0.07125	0	0.09275	0	0.11425	0.535609	0.13575	1.07112		
0.07175	0	0.09325	0.357084	0.11475	0.178548	0.13625	0.714123		
0.07225	0	0.09375	0	0.11525	-0.357129	0.13675	0.535609		
0.07275	0	0.09425	0	0.11575	0.357084	0.13725	0.535609		
0.07325	0.178548	0.09475	0.178548	0.11625	0	0.13775	2.14183		
0.07375	0	0.09525	0.178548	0.11675	-0.53571	0.13825	0.178548		
0.07425	0.178548	0.09575	0.357084	0.11725	0.178548	0.13875	0.357084		
0.07475	0.178548	0.09625	-0.892907	0.11775	-0.357129	0.13925	0.535609		
0.07525	0.178548	0.09675	-0.178559	0.11825	0.178548	0.13975	0.535609		
0.07575	0	0.09725	0.357084	0.11875	0.178548	0.14025	0.178548		
0.07625	0.178548	0.09775	0.357084	0.11925	0.178548	0.14075	2.32024		

Gauge28_1 Time msec	Gauge28_1 Stress MPa	Gauge28_1 Time msec	Gauge28_1 Stress MPa	Gauge28_1 Time msec	Gauge28_1 Stress MPa	Gauge28_1 Time msec	Gauge28_1 Stress MPa	Gauge28_2 Time msec	Gauge28_2 Stress MPa
-0.034	0	-0.0125	0	0.009	-56.0554	0.0305	-27.8896	-0.0185	0
-0.0335	0	-0.012	-27.8896	0.0095	-56.0554	0.031	-56.0554	-0.018	0.340704
-0.033	0	-0.0115	-27.8896	0.01	-27.8896	0.0315	-56.0554	-0.0175	0
-0.0325	0	-0.011	0	0.0105	0	0.032	-56.0554	-0.017	0
-0.032	0	-0.0105	0	0.011	27.6133	0.0325	-56.0554	-0.0165	0
-0.0315	0	-0.01	0	0.0115	54.9503	0.033	-56.0554	-0.016	-0.681537
-0.031	0	-0.0095	0	0.012	54.9503	0.0335	-56.0554	-0.0155	-0.681537
-0.0305	0	-0.009	-27.8896	0.0125	27.6133	0.034	-56.0554	-0.015	-0.681537
-0.03	0	-0.0085	0	0.013	-27.8896	0.0345	-56.0554	-0.0145	0.340704
-0.0295	0	-0.008	0	0.0135	-56.0554	0.035	-56.0554	-0.014	0.681365
-0.029	0	-0.0075	-27.8896	0.014	0	0.0355	-56.0554	-0.0135	0.340704
-0.0285	0	-0.007	0	0.0145	0	0.036	-56.0554	-0.013	0.340704
-0.028	0	-0.0065	0	0.015	0	0.0365	-56.0554	-0.0125	0.340704
-0.0275	0	-0.006	0	0.0155	0	0.037	-56.0554	-0.012	3.002E-13
-0.027	0	-0.0055	0	0.016	-27.8896	0.0375	-56.0554	-0.0115	-0.340747
-0.0265	0	-0.005	0	0.0165	-27.8896	0.038	-27.8896	-0.011	0
-0.026	0	-0.0045	0	0.017	-56.0554	0.0385	-27.8896	-0.0105	0
-0.0255	-27.8896	-0.004	0	0.0175	-56.0554	0.039	-27.8896	-0.01	0
-0.025	-56.0554	-0.0035	0	0.018	-56.0554	0.0395	-27.8896	-0.0095	0
-0.0245	0	-0.003	0	0.0185	-27.8896	0.04	-27.8896	-0.009	0
-0.024	-27.8896	-0.0025	0	0.019	-56.0554	0.0405	-27.8896	-0.0085	0
-0.0235	-27.8896	-0.002	0	0.0195	-56.0554	0.041	0	-0.008	0.340704
-0.023	0	-0.0015	-27.8896	0.02	-56.0554	0.0415	0	-0.0075	0.340704
-0.0225	-27.8896	-0.001	-27.8896	0.0205	-27.8896	0.042	0	-0.007	0
-0.022	-27.8896	-0.0005	0	0.021	-27.8896	0.0425	0	-0.0065	0
-0.0215	-27.8896	0	0	0.0215	-27.8896	0.043	-27.8896	-0.006	0
-0.021	-27.8896	0.0005	161.536	0.022	-27.8896	0.0435	0	-0.0055	-0.340747
-0.0205	0	0.001	238.574	0.0225	27.6133	0.044	27.6133	-0.005	-0.340747
-0.02	0	0.0015	408.598	0.023	82.0111	0.0445	54.9503	-0.0045	0
-0.0195	0	0.002	832.533	0.0235	82.0111	0.045	82.0111	-0.004	0
-0.019	0	0.0025	913.264	0.024	82.0111	0.0455	82.0111	-0.0035	0
-0.0185	0	0.003	792.994	0.0245	82.0111	0.046	82.0111	-0.003	0
-0.018	0	0.0035	715.793	0.025	54.9503	0.0465	82.0111	-0.0025	-0.340747
-0.0175	0	0.004	715.793	0.0255	54.9503	0.047	82.0111	-0.002	0
-0.017	0	0.0045	470.164	0.026	27.6133	0.0475	54.9503	-0.0015	0
-0.0165	0	0.005	238.574	0.0265	27.6133	0.048	54.9503	-0.001	0
-0.016	0	0.0055	108.796	0.027	27.6133	0.0485	54.9503	-0.0005	-0.340747
-0.0155	27.6133	0.006	82.0111	0.0275	0	0.049	27.6133	0	0
-0.015	54.9503	0.0065	0	0.028	-27.8896	0.0495	27.6133	0.0005	1.02198
-0.0145	0	0.007	-84.4975	0.0285	-27.8896	0.05	0	0.001	0.681365
-0.014	27.6133	0.0075	-84.4975	0.029	-27.8896	0.0505	-56.0554	0.0015	0
-0.0135	27.6133	0.008	0	0.0295	-56.0554	0.051	0	0.002	0.340704
-0.013	-27.8896	0.0085	-56.0554	0.03	-56.0554	0.0515	0	0.0025	-0.340747

Gauge28_2 Time msec	Gauge28_2 Stress MPa	Gauge28_2 Time msec	Gauge28_2 Stress MPa	Gauge28_2 Time msec	Gauge28_2 Stress MPa	Gauge28_3 Time msec	Gauge28_3 Stress MPa	Gauge28_3 Time msec	Gauge28_3 Stress MPa
0.003	1.02198	0.0245	-3.4094	0.046	0.681365	-0.024	-2.47232	-0.0025	-0.353055
0.0035	0.681365	0.025	-2.38613	0.0465	3.06479	-0.0235	-2.47232	-0.002	0
0.004	0	0.0255	-3.4094	0.047	2.72443	-0.023	-2.47232	-0.0015	0
0.0045	-0.340747	0.026	-2.72718	0.0475	1.70309	-0.0225	-7.77748	-0.001	-0.353055
0.005	0	0.0265	-2.72718	0.048	0.681365	-0.022	-0.706155	-0.0005	-3.11E-13
0.0055	-1.70416	0.027	-4.77436	0.0485	1.02198	-0.0215	-0.706155	0	-0.353055
0.006	0	0.0275	-3.06827	0.049	1.36256	-0.021	-1.76572	0.0005	-0.353055
0.0065	2.04358	0.028	-3.75058	0.0495	2.04358	-0.0205	-0.706155	0.001	-0.353055
0.007	-0.340747	0.0285	-4.43306	0.05	3.06479	-0.02	-0.353055	0.0015	-0.353055
0.0075	-3.4094	0.029	-4.09179	0.0505	1.36256	-0.0195	-0.353055	0.002	-0.353055
0.008	-4.77436	0.0295	-3.4094	0.051	3.40511	-0.019	-0.706155	0.0025	-0.353055
0.0085	0	0.03	-1.02237	0.0515	5.44612	-0.0185	0	0.003	0.353011
0.009	-2.72718	0.0305	-2.38613	0.052	4.76595	-0.018	-0.353055	0.0035	-0.706155
0.0095	-2.04512	0.031	-1.36324	0.0525	-1.36324	-0.0175	0	0.004	-0.706155
0.01	-5.79853	0.0315	-3.06827	0.053	-6.82309	-0.017	-0.353055	0.0045	-0.706155
0.0105	-1.02237	0.032	-2.38613	0.0535	9.52349	-0.0165	0	0.005	-0.706155
0.011	0.681365	0.0325	-1.36324	0.054	1.02025	-0.016	-0.353055	0.0055	-0.706155
0.0115	1.70309	0.033	-0.681537	0.0545	-1.70416	-0.0155	0	0.006	-0.706155
0.012	-1.02237	0.0335	1.02198	0.055	-1.70416	-0.015	-0.353055	0.0065	-0.706155
0.0125	-0.340747	0.034	-1.70416	0.0555	7.82534	-0.0145	0	0.007	-0.706155
0.013	2.72443	0.0345	-1.70416	0.056	-11.2206	-0.014	0	0.0075	-0.353055
0.0135	0.681365	0.035	-1.70416	0.0565	3.74538	-0.0135	-0.353055	0.008	0
0.014	-2.72718	0.0355	-1.02237	0.057	0.681365	-0.013	-0.353055	0.0085	0
0.0145	0.681365	0.036	-0.681537	0.0575	3.06479	-0.0125	0	0.009	0
0.015	1.02198	0.0365	0	0.058	2.04358	-0.012	0	0.0095	0
0.0155	0.340704	0.037	-0.340747			-0.0115	-0.353055	0.01	0
0.016	0	0.0375	-0.681537			-0.011	-0.353055	0.0105	0
0.0165	1.70309	0.038	-0.681537			-0.0105	-0.353055	0.011	-0.353055
0.017	2.04358	0.0385	0.340704			-0.01	-0.353055	0.0115	-0.353055
0.0175	1.36256	0.039	-1.36324			-0.0095	0	0.012	-0.353055
0.018	-0.681537	0.0395	-0.681537			-0.009	0	0.0125	-0.353055
0.0185	0.681365	0.04	-1.36324			-0.0085	0	0.013	-0.353055
0.019	3.74538	0.0405	-1.36324			-0.008	0	0.0135	0
0.0195	-0.340747	0.041	-3.06827			-0.0075	-0.353055	0.014	0
0.02	-1.70416	0.0415	2.04358			-0.007	-0.353055	0.0145	0
0.0205	-0.681537	0.042	-0.681537			-0.0065	-0.353055	0.015	0
0.021	1.36256	0.0425	-0.681537			-0.006	-0.353055	0.0155	0.353011
0.0215	0.340704	0.043	1.36256			-0.0055	0	0.016	0.353011
0.022	0.340704	0.0435	0.681365			-0.005	0	0.0165	0.705977
0.0225	-0.681537	0.044	1.02198			-0.0045	0	0.017	0.705977
0.023	-0.340747	0.0445	0.340704			-0.004	-0.353055	0.0175	0.705977
0.0235	-1.70416	0.045	-0.681537			-0.0035	-0.353055	0.018	1.0589
0.024	-1.70416	0.0455	-1.02237			-0.003	-0.353055	0.0185	1.0589

Gauge28_3 Time msec	Gauge28_3 Stress MPa	Gauge28_3 Time msec	Gauge28_3 Stress MPa	Gauge28_3 Time msec	Gauge28_3 Stress MPa	Gauge28_3 Time msec	Gauge28_3 Stress MPa	Gauge28_4 Time msec	Gauge28_4 Stress MPa
0.019	1.0589	0.0405	1.0589	0.062	39.2609	0.0835	-5.3005	-0.0205	-2.14758
0.0195	0.705977	0.041	1.0589	0.0625	30.5456	0.084	2.47014	-0.02	-1.07359
0.02	0.705977	0.0415	1.0589	0.063	19.7001	0.0845	-4.2396	-0.0195	-1.07359
0.0205	0.705977	0.042	1.0589	0.0635	13.3832	0.085	1.0589	-0.019	-0.715679
0.021	0.705977	0.0425	0.705977	0.064	9.8675	0.0855	0.705977	-0.0185	-0.715679
0.0215	0.705977	0.043	0.353011	0.0645	5.99514	0.086	-5.3005	-0.018	-0.715679
0.022	0.705977	0.0435	0.353011	0.065	4.93811	0.0865	2.47014	-0.0175	-0.715679
0.0225	0.705977	0.044	0.353011	0.0655	4.2332	0.087	0.353011	-0.017	-0.357817
0.023	0.705977	0.0445	0.353011	0.066	4.58567	0.0875	9.16383	-0.0165	0
0.0235	0.705977	0.045	0	0.0665	4.93811	0.088	2.82284	-0.016	0
0.024	0.705977	0.0455	0.353011	0.067	7.75597	0.0885	0.353011	-0.0155	0
0.0245	0.353011	0.046	0.353011	0.0675	9.51569	0.089	-5.65422	-0.015	-0.715679
0.025	0.705977	0.0465	0.353011	0.068	6.6996	0.0895	4.2332	-0.0145	-0.715679
0.0255	0.705977	0.047	0.705977	0.0685	6.6996	0.09	3.1755	-0.014	-0.715679
0.026	0.705977	0.0475	0.705977	0.069	5.64284	0.0905	4.2332	-0.0135	0
0.0265	1.0589	0.048	0.705977	0.0695	5.64284	0.091	5.29049	-0.013	0
0.027	0.705977	0.0485	0.705977	0.07	1.0589	0.0915	-5.3005	-0.0125	0
0.0275	0.353011	0.049	0.705977	0.0705	5.29049	0.092	3.1755	-0.012	0
0.028	0.353011	0.0495	0.705977	0.071	-4.59319	0.0925	21.102	-0.0115	0
0.0285	0.353011	0.05	1.0589	0.0715	-21.6177	0.093	15.8415	-0.011	0
0.029	0.353011	0.0505	1.0589	0.072	-14.8666	0.0935	14.437	-0.0105	-0.357817
0.0295	0.705977	0.051	0.705977	0.0725	-15.5765	0.094	15.4904	-0.01	0
0.03	0.705977	0.0515	0.705977	0.073	-11.6743	0.0945	7.75597	-0.0095	-0.357817
0.0305	0.705977	0.052	0.353011	0.0735	-19.4841	0.095	3.52811	-0.009	-0.357817
0.031	0.705977	0.0525	0.705977	0.074	-21.9735	0.0955	7.05177	-0.0085	0.357772
0.0315	0.705977	0.053	0.705977	0.0745	-12.738	0.096	9.8675	-0.008	0
0.032	0.705977	0.0535	1.0589	0.075	-13.8021	0.0965	4.93811	-0.0075	0
0.0325	1.0589	0.054	1.41178	0.0755	-7.77748	0.097	-0.706155	-0.007	0
0.033	1.0589	0.0545	1.76461	0.076	-0.706155	0.0975	-4.94682	-0.0065	0
0.0335	1.0589	0.055	2.1174	0.0765	-8.13152	0.098	-6.3618	-0.006	-0.357817
0.034	1.0589	0.0555	3.1755	0.077	-6.71565	0.0985	-13.4474	-0.0055	0
0.0345	1.0589	0.056	5.64284	0.0775	-10.2567	0.099	-10.2567	-0.005	-0.357817
0.035	1.0589	0.0565	15.1393	0.078	-2.82569	0.0995	1.0589	-0.0045	0.357772
0.0355	0.705977	0.057	37.1718	0.0785	-4.2396	0.1	-2.47232	-0.004	0
0.036	1.0589	0.0575	53.4937	0.079	-12.0288	0.1005	-4.59319	-0.0035	0
0.0365	1.0589	0.058	52.8012	0.0795	-17.7072	0.101	-12.3834	-0.003	0
0.037	0.705977	0.0585	53.1475	0.08	-12.0288	0.1015	-9.90235	-0.0025	0
0.0375	1.0589	0.059	38.2165	0.0805	-9.19388			-0.002	0
0.038	0.705977	0.0595	10.571	0.081	-10.9654			-0.0015	0
0.0385	1.0589	0.06	2.82284	0.0815	-9.90235			-0.001	-0.357817
0.039	0.705977	0.0605	15.1393	0.082	-6.00798			-0.0005	0
0.0395	1.0589	0.061	32.6398	0.0825	-6.00798			0	0
0.04	1.0589	0.0615	38.2165	0.083	-7.06955			0.0005	0

Gauge28_4 Time msec	Gauge28_4 Stress MPa	Gauge28_4 Time msec	Gauge28_4 Stress MPa	Gauge28_4 Time msec	Gauge28_4 Stress MPa	Gauge28_4 Time msec	Gauge28_4 Stress MPa	Gauge28_4 Time msec	Gauge28_4 Stress MPa
0.001	0	0.0225	-0.357817	0.044	-3.22198	0.0655	-1.43154	0.087	-1.07359
0.0015	0	0.023	0	0.0445	-3.22198	0.066	-1.07359	0.0875	-1.43154
0.002	0	0.0235	0	0.045	-3.22198	0.0665	-1.43154	0.088	-1.07359
0.0025	0	0.024	0	0.0455	-3.22198	0.067	-1.43154	0.0885	-1.78954
0.003	0	0.0245	0	0.046	-3.22198	0.0675	-1.43154	0.089	-1.43154
0.0035	-0.357817	0.025	-0.357817	0.0465	-3.22198	0.068	-1.07359	0.0895	-1.43154
0.004	0	0.0255	0	0.047	-3.22198	0.0685	-1.43154	0.09	-1.07359
0.0045	0	0.026	0	0.0475	-3.22198	0.069	-1.07359	0.0905	-0.715679
0.005	0	0.0265	0	0.048	-3.5802	0.0695	-1.07359	0.091	0
0.0055	0	0.027	0	0.0485	-3.22198	0.07	-1.07359	0.0915	0
0.006	0	0.0275	0	0.049	-3.22198	0.0705	-1.07359	0.092	1.07318
0.0065	-0.357817	0.028	0	0.0495	-3.5802	0.071	-1.07359	0.0925	4.64752
0.007	-0.357817	0.0285	0	0.05	-2.8638	0.0715	-1.07359	0.093	1.43082
0.0075	-0.357817	0.029	0	0.0505	-2.8638	0.072	-0.715679	0.0935	0
0.008	0	0.0295	0	0.051	-2.8638	0.0725	-0.357817	0.094	0
0.0085	0.357772	0.03	0	0.0515	-2.50567	0.073	-0.357817	0.0945	-0.357817
0.009	0.715499	0.0305	0.357772	0.052	-2.50567	0.0735	-0.715679	0.095	-0.715679
0.0095	0	0.031	0	0.0525	-2.8638	0.074	-0.715679	0.0955	-1.43154
0.01	0.715499	0.0315	0	0.053	-2.14758	0.0745	-0.715679	0.096	1.07318
0.0105	0.715499	0.032	0.357772	0.0535	-1.78954	0.075	0	0.0965	-0.357817
0.011	0.357772	0.0325	0.715499	0.054	-1.43154	0.0755	-0.715679	0.097	0
0.0115	0.357772	0.033	0	0.0545	-1.43154	0.076	-0.715679	0.0975	-1.43154
0.012	0.357772	0.0335	0.715499	0.055	-1.07359	0.0765	-3.152E-13	0.098	1.78841
0.0125	0.357772	0.034	0	0.0555	-1.07359	0.077	0	0.0985	-1.43154
0.013	0	0.0345	0	0.056	-0.715679	0.0775	-0.357817	0.099	-2.50567
0.0135	0.357772	0.035	0	0.0565	-0.715679	0.078	-0.357817	0.0995	-2.8638
0.014	0	0.0355	0	0.057	-0.715679	0.0785	-0.715679	0.1	-3.22198
0.0145	0	0.036	-0.357817	0.0575	-0.715679	0.079	-0.715679	0.1005	-3.22198
0.015	-0.357817	0.0365	-0.357817	0.058	-0.715679	0.0795	-0.715679	0.101	-0.715679
0.0155	0	0.037	-0.357817	0.0585	-0.715679	0.08	-0.715679	0.1015	0.715499
0.016	0	0.0375	-0.715679	0.059	-0.715679	0.0805	-0.715679	0.102	-2.14758
0.0165	0	0.038	-0.715679	0.0595	-0.715679	0.081	-1.07359	0.1025	-4.65514
0.017	0.357772	0.0385	-1.43154	0.06	-1.07359	0.0815	-1.07359	0.103	-1.78954
0.0175	-0.357817	0.039	-1.43154	0.0605	-1.07359	0.082	-1.07359	0.1035	-1.43154
0.018	0	0.0395	-1.78954	0.061	-0.715679	0.0825	-0.715679	0.104	-10.7541
0.0185	-0.357817	0.04	-1.78954	0.0615	-0.715679	0.083	-0.357817	0.1045	-7.88238
0.019	0	0.0405	-2.50567	0.062	-0.715679	0.0835	-1.43154	0.105	-8.95894
0.0195	0.357772	0.041	-2.50567	0.0625	-0.715679	0.084	3.57569	0.1055	-4.29678
0.02	0	0.0415	-2.8638	0.063	-1.43154	0.0845	0	0.106	-1.78954
0.0205	0	0.042	-2.8638	0.0635	-1.07359	0.085	2.14596	0.1065	-1.43154
0.021	-0.357817	0.0425	-2.8638	0.064	-1.07359	0.0855	1.07318	0.107	-1.07359
0.0215	-0.357817	0.043	-2.8638	0.0645	-1.07359	0.086	-0.357817	0.1075	-1.43154
0.022	-0.357817	0.0435	-2.8638	0.065	-1.43154	0.0865	-0.715679	0.108	-1.78954

Gauge28_4 Time msec	Gauge28_4 Stress MPa	Gauge28_4 Time msec	Gauge28_4 Stress MPa	Gauge28_5 Time msec	Gauge28_5 Stress MPa	Gauge28_5 Time msec	Gauge28_5 Stress MPa	Gauge28_5 Time msec	Gauge28_5 Stress MPa
0.1085	-2.50567	0.13	-9.31789	-0.0225	-0.690404	-0.001	0.345137	0.0205	0.345137
0.109	-3.5802	0.1305	-11.1133	-0.022	-0.690404	-0.0005	0.345137	0.021	3.0656E-13
0.1095	-3.5802	0.131	-12.9098	-0.0215	-0.690404	0	0.345137	0.0215	0
0.11	-4.65514	0.1315	-13.6287	-0.021	-1.87019	0.0005	0.345137	0.022	0.345137
0.1105	-5.37199	0.132	-15.4268	-0.0205	4.82796	0.001	0	0.0225	0.345137
0.111	-6.4476	0.1325	-16.8661	-0.02	-3.10819	0.0015	0.345137	0.023	0
0.1115	-7.52362	0.133	-17.586	-0.0195	-2.76266	0.002	0	0.0235	0
0.112	-10.0359	0.1335	-19.0264	-0.019	-1.03567	0.0025	0.345137	0.024	0
0.1125	-8.95894	0.134	-19.3866	-0.0185	-0.34518	0.003	-0.34518	0.0245	0
0.113	-9.31789	0.1345	-20.1071	-0.018	0	0.0035	0.345137	0.025	0
0.1135	-8.95894	0.135	-22.2699	-0.0175	0.345137	0.004	0.345137	0.0255	-0.34518
0.114	-7.1649	0.1355	-24.4342	-0.017	0	0.0045	0	0.026	0
0.1145	-6.08902	0.136	-25.156	-0.0165	-0.34518	0.005	0	0.0265	0
0.115	-5.73048	0.1365	-26.6002	-0.016	-0.690404	0.0055	0.345137	0.027	0
0.1155	-5.37199	0.137	-27.6837	-0.0155	0	0.006	0	0.0275	0
0.116	-0.357817	0.1375	-28.7677	-0.015	0.345137	0.0065	-0.34518	0.028	0
0.1165	-5.01354	0.138	-30.2137	-0.0145	0.345137	0.007	0	0.0285	0
0.117	-3.5802	0.1385	-31.6604	-0.014	0.69023	0.0075	0.345137	0.029	0.345137
0.1175	2.50346	0.139	-33.4697	-0.0135	0	0.008	0.345137	0.0295	0
0.118	6.78996	0.1395	-34.5559	-0.013	0.345137	0.0085	0.345137	0.03	0
0.1185	13.9197	0.14	-36.367	-0.0125	0	0.009	0.345137	0.0305	0
0.119	21.7416	0.1405	-36.0047	-0.012	0.345137	0.0095	0.69023	0.031	0
0.1195	29.1877	0.141	-36.367	-0.0115	0	0.01	0	0.0315	0
0.12	34.1407	0.1415	-36.0047	-0.011	0	0.0105	0.345137	0.032	0
0.1205	31.6653	0.142	-36.367	-0.0105	0.345137	0.011	0.345137	0.0325	0.345137
0.121	27.0623	0.1425	-36.367	-0.01	0	0.0115	0	0.033	0.345137
0.1215	24.5806	0.143	-36.367	-0.0095	0	0.012	0	0.0335	0.345137
0.122	28.8336	0.1435	-36.367	-0.009	0	0.0125	0	0.034	0.345137
0.1225	25.6444	0.144	-36.367	-0.0085	0.345137	0.013	0	0.0345	0.69023
0.123	22.8066	0.1445	-36.367	-0.008	0.345137	0.0135	0.345137	0.035	0.69023
0.1235	21.0315	0.145	-36.367	-0.0075	0.345137	0.014	0.345137	0.0355	0.345137
0.124	18.8998			-0.007	0.69023	0.0145	0.345137	0.036	0.345137
0.1245	16.0551			-0.0065	0.69023	0.015	0	0.0365	0
0.125	13.5637			-0.006	0.345137	0.0155	0.345137	0.037	0
0.1255	11.07			-0.0055	0.345137	0.016	0.345137	0.0375	0
0.126	7.50375			-0.005	0.345137	0.0165	0	0.038	-0.34518
0.1265	3.57569			-0.0045	0.345137	0.017	0.345137	0.0385	0
0.127	1.07318			-0.004	0.345137	0.0175	0.345137	0.039	-0.34518
0.1275	-1.43154			-0.0035	0	0.018	0	0.0395	-0.34518
0.128	-3.5802			-0.003	0	0.0185	0	0.04	-0.34518
0.1285	-5.73048			-0.0025	0	0.019	0	0.0405	-0.34518
0.129	-6.80623			-0.002	0.345137	0.0195	0.345137	0.041	-0.690404
0.1295	-7.88238			-0.0015	0	0.02	0.345137	0.0415	-0.34518

Gauge28_5	Gauge28_5	Gauge28_5	Gauge28_5	Gauge28_5	Gauge28_5	Gauge28_5	Gauge28_5	Gauge28_5	Gauge28_5
Time	Stress	Time	Stress	Time	Stress	Time	Stress	Time	Stress
msec	MPa	msec	MPa	msec	MPa	msec	MPa	msec	MPa
0.042	-0.690404	0.0635	-2.76266	0.085	-0.34518	0.1065	-1.03567	0.128	62.0991
0.0425	-0.690404	0.064	-2.76266	0.0855	-0.34518	0.107	-1.03567	0.1285	62.0991
0.043	-1.03567	0.0645	-2.76266	0.086	-0.690404	0.1075	-1.03567	0.129	62.0991
0.0435	-1.03567	0.065	-2.76266	0.0865	-0.690404	0.108	-1.38098	0.1295	62.0991
0.044	-1.03567	0.0655	-2.76266	0.087	-0.34518	0.1085	-1.03567	0.13	62.0991
0.0445	-1.72634	0.066	-2.76266	0.0875	-0.34518	0.109	-1.38098	0.1305	62.0991
0.045	-1.03567	0.0665	-2.76266	0.088	-0.34518	0.1095	-1.38098	0.131	62.0991
0.0455	-1.72634	0.067	-2.41718	0.0885	-0.34518	0.11	-1.38098	0.1315	62.0991
0.046	-2.07173	0.0675	-2.76266	0.089	-0.34518	0.1105	-1.38098	0.132	62.0991
0.0465	-2.07173	0.068	-2.41718	0.0895	-0.690404	0.111	-1.72634	0.1325	62.0991
0.047	-2.07173	0.0685	-2.41718	0.09	-0.690404	0.1115	-1.38098	0.133	62.0991
0.0475	-2.07173	0.069	-2.07173	0.0905	-0.34518	0.112	-1.03567	0.1335	62.0991
0.048	-2.41718	0.0695	-2.07173	0.091	-0.34518	0.1125	-0.690404	0.134	62.0991
0.0485	-2.41718	0.07	-2.07173	0.0915	0.345137	0.113	0.69023	0.1345	62.0991
0.049	-2.41718	0.0705	-2.07173	0.092	0	0.1135	2.75988	0.135	62.4363
0.0495	-2.76266	0.071	-2.41718	0.0925	0	0.114	5.86142	0.1355	57.7112
0.05	-2.76266	0.0715	-1.72634	0.093	0	0.1145	10.3352	0.136	48.9133
0.0505	-2.76266	0.072	-2.07173	0.0935	0	0.115	15.8313	0.1365	43.8243
0.051	-3.10819	0.0725	-1.72634	0.094	0	0.1155	24.0546	0.137	42.1257
0.0515	-3.10819	0.073	-1.38098	0.0945	0	0.116	32.2529	0.1375	43.8243
0.052	-3.10819	0.0735	-1.38098	0.095	0	0.1165	40.7661	0.138	48.2353
0.0525	-2.76266	0.074	-1.38098	0.0955	0.345137	0.117	48.9133	0.1385	52.9775
0.053	-3.10819	0.0745	-1.38098	0.096	0	0.1175	55.6835	0.139	56.0215
0.0535	-3.10819	0.075	-1.38098	0.0965	0	0.118	60.0748	0.1395	57.3733
0.054	-3.10819	0.0755	-0.690404	0.097	-0.34518	0.1185	61.7618	0.14	57.0354
0.0545	-3.10819	0.076	-0.690404	0.0975	0	0.119	60.7497	0.1405	58.0489
0.055	-3.10819	0.0765	-0.690404	0.098	0	0.1195	55.0073	0.141	59.0621
0.0555	-3.10819	0.077	-0.34518	0.0985	0	0.12	44.8429	0.1415	60.7497
0.056	-3.10819	0.0775	-0.34518	0.099	0	0.1205	31.9118	0.142	61.7618
0.0565	-3.45376	0.078	0	0.0995	0	0.121	19.2607	0.1425	61.7618
0.057	-3.45376	0.0785	0	0.1	-0.34518	0.1215	11.0228	0.143	62.0991
0.0575	-3.10819	0.079	0	0.1005	-0.34518	0.122	11.0228	0.1435	62.0991
0.058	-3.10819	0.0795	0.345137	0.101	-0.34518	0.1225	19.6034	0.144	61.7618
0.0585	-3.10819	0.08	0.345137	0.1015	-0.34518	0.123	33.9577	0.1445	61.7618
0.059	-3.10819	0.0805	0	0.102	-0.34518	0.1235	49.9299	0.145	61.7618
0.0595	-3.10819	0.081	0	0.1025	-0.690404	0.124	62.7735	0.1455	61.7618
0.06	-3.10819	0.0815	0	0.103	-1.03567	0.1245	62.4363	0.146	61.7618
0.0605	-3.10819	0.082	0	0.1035	-1.03567	0.125	62.4363	0.1465	61.7618
0.061	-2.76266	0.0825	0	0.104	-0.690404	0.1255	62.4363	0.147	61.7618
0.0615	-2.76266	0.083	0	0.1045	-1.03567	0.126	62.4363	0.1475	61.7618
0.062	-2.76266	0.0835	-0.34518	0.105	-1.03567	0.1265	62.4363	0.148	61.7618
0.0625	-2.76266	0.084	-0.690404	0.1055	-1.03567	0.127	62.0991	0.1485	61.7618
0.063	-2.76266	0.0845	-0.34518	0.106	-0.690404	0.1275	62.4363	0.149	61.7618

Gauge28_5	Gauge28_5	Gauge28_5	Gauge28_5	Gauge28_6	Gauge28_6	Gauge28_6	Gauge28_6	Gauge28_6	Gauge28_6
Time	Stress	Time	Stress	Time	Stress	Time	Stress	Time	Stress
msec	MPa	msec	MPa	msec	MPa	msec	MPa	msec	MPa
0.1495	61.7618	0.171	7.92715	-0.024	0	-0.0025	0	0.019	-0.173878
0.15	61.7618	0.1715	2.07017	-0.0235	0	-0.002	0	0.0195	-0.173878
0.1505	61.7618	0.172	-4.49074	-0.023	0.695401	-0.0015	0	0.02	0
0.151	61.7618	0.1725	-10.7208	-0.0225	-0.347766	-0.001	0	0.0205	-0.173878
0.1515	61.7618	0.173	-19.397	-0.022	1.21684	-0.0005	0.173867	0.021	-0.173878
0.152	61.7618	0.1735	-26.3576	-0.0215	0.695401	0	0	0.0215	-0.173878
0.1525	61.7618	0.174	-26.3576	-0.021	-0.695576	0.0005	-0.173878	0.022	-0.173878
0.153	61.4245	0.1745	-26.3576	-0.0205	-0.347766	0.001	0.173867	0.0225	0
0.1535	61.4245			-0.02	0.347722	0.0015	0	0.023	0
0.154	61.7618			-0.0195	0.173867	0.002	0	0.0235	-0.173878
0.1545	61.7618			-0.019	0	0.0025	0	0.024	-0.173878
0.155	61.7618			-0.0185	0	0.003	0	0.0245	-0.173878
0.1555	61.4245			-0.018	0	0.0035	0	0.025	-0.173878
0.156	61.7618			-0.0175	0	0.004	0.173867	0.0255	-0.173878
0.1565	61.4245			-0.017	-0.173878	0.0045	0	0.026	-0.173878
0.157	61.4245			-0.0165	0	0.005	0	0.0265	-0.173878
0.1575	61.4245			-0.016	0	0.0055	-0.173878	0.027	0
0.158	61.4245			-0.0155	0	0.006	-0.173878	0.0275	-0.173878
0.1585	61.4245			-0.015	0	0.0065	0	0.028	-0.173878
0.159	61.4245			-0.0145	-0.173878	0.007	-0.173878	0.0285	-0.173878
0.1595	61.4245			-0.014	0	0.0075	0	0.029	-0.173878
0.16	61.4245			-0.0135	0	0.008	0	0.0295	-0.173878
0.1605	61.4245			-0.013	0	0.0085	0	0.03	-0.173878
0.161	61.4245			-0.0125	0	0.009	0.173867	0.0305	0
0.1615	61.4245			-0.012	-0.173878	0.0095	0	0.031	-0.173878
0.162	61.4245			-0.0115	0	0.01	0.173867	0.0315	0
0.1625	61.4245			-0.011	0	0.0105	0.173867	0.032	0
0.163	61.4245			-0.0105	0	0.011	0	0.0325	-0.173878
0.1635	60.7497			-0.01	0	0.0115	0	0.033	-0.173878
0.164	59.7373			-0.0095	0	0.012	0	0.0335	0
0.1645	57.7112			-0.009	0	0.0125	0	0.034	0
0.165	56.0215			-0.0085	0.173867	0.013	0	0.0345	0
0.1655	54.6691			-0.008	0	0.0135	-0.173878	0.035	-0.173878
0.166	52.3006			-0.0075	0	0.014	0	0.0355	0
0.1665	48.9133			-0.007	-0.173878	0.0145	-0.173878	0.036	0
0.167	45.1823			-0.0065	0	0.015	0	0.0365	0
0.1675	42.1257			-0.006	0	0.0155	0	0.037	-0.173878
0.168	38.7254			-0.0055	-0.173878	0.016	-0.173878	0.0375	0
0.1685	33.577			-0.005	0.173867	0.0165	0	0.038	0.173867
0.169	28.4985			-0.0045	0	0.017	-0.173878	0.0385	0
0.1695	24.0546			-0.004	0	0.0175	0	0.039	0
0.17	19.2607			-0.0035	0	0.018	0	0.0395	0
0.1705	13.4281			-0.003	0.173867	0.0185	-0.173878	0.04	0



Gauge28_6 Time msec	Gauge28_6 Stress MPa	Gauge28_6 Time msec	Gauge28_6 Stress MPa	Gauge28_6 Time msec	Gauge28_6 Stress MPa	Gauge28_6 Time msec	Gauge28_6 Stress MPa	Gauge28_6 Time msec	Gauge28_6 Stress MPa
0.0405	0	0.062	0	0.0835	-0.521665	0.105	-0.521665	0.1265	-0.173878
0.041	0	0.0625	0	0.084	-0.521665	0.1055	-0.173878	0.127	-0.347766
0.0415	0.173867	0.063	0	0.0845	-0.347766	0.106	0	0.1275	-0.173878
0.042	0.347722	0.0635	-0.173878	0.085	-0.347766	0.1065	-0.173878	0.128	-0.173878
0.0425	0	0.064	0.173867	0.0855	-0.521665	0.107	-0.173878	0.1285	0
0.043	0	0.0645	0	0.086	-0.521665	0.1075	0	0.129	0.173867
0.0435	0	0.065	0.347722	0.0865	-0.521665	0.108	0	0.1295	0
0.044	0	0.0655	0.173867	0.087	-0.695576	0.1085	0	0.13	0.347722
0.0445	0	0.066	0.173867	0.0875	-0.695576	0.109	0	0.1305	0.521567
0.045	0	0.0665	0.347722	0.088	-0.695576	0.1095	0	0.131	0.347722
0.0455	0	0.067	0.347722	0.0885	-0.695576	0.11	0	0.1315	0.347722
0.046	0	0.0675	0.347722	0.089	-0.695576	0.1105	0	0.132	0.695401
0.0465	0	0.068	0.521567	0.0895	-0.869497	0.111	0	0.1325	0.695401
0.047	0	0.0685	0.695401	0.09	-0.869497	0.1115	0	0.133	0.695401
0.0475	0.173867	0.069	0.695401	0.0905	-0.869497	0.112	-0.173878	0.1335	0.695401
0.048	0.173867	0.0695	0.521567	0.091	-0.869497	0.1125	-0.347766	0.134	0.695401
0.0485	0.173867	0.07	0.521567	0.0915	-0.869497	0.113	-0.173878	0.1345	0.695401
0.049	0.173867	0.0705	0.695401	0.092	-1.04343	0.1135	-0.347766	0.135	0.521567
0.0495	0.173867	0.071	0.521567	0.0925	-0.869497	0.114	-0.347766	0.1355	0.347722
0.05	0	0.0715	0.695401	0.093	-0.869497	0.1145	-0.173878	0.136	0.347722
0.0505	0	0.072	0.521567	0.0935	-0.869497	0.115	-0.347766	0.1365	0.173867
0.051	0	0.0725	0.521567	0.094	-0.869497	0.1155	-0.347766	0.137	0.173867
0.0515	0	0.073	0.695401	0.0945	-1.04343	0.116	-0.347766	0.1375	0
0.052	0	0.0735	0.521567	0.095	-0.869497	0.1165	-0.521665	0.138	-0.521665
0.0525	0	0.074	0.347722	0.0955	-0.869497	0.117	-0.347766	0.1385	-0.347766
0.053	0	0.0745	0.347722	0.096	-0.869497	0.1175	-0.347766	0.139	-0.695576
0.0535	0	0.075	0.347722	0.0965	-0.869497	0.118	-0.521665	0.1395	-0.869497
0.054	0	0.0755	0.173867	0.097	-0.869497	0.1185	-0.695576	0.14	-1.21737
0.0545	-0.173878	0.076	0.173867	0.0975	-0.869497	0.119	-0.347766	0.1405	-1.21737
0.055	0	0.0765	0.173867	0.098	-0.869497	0.1195	-0.521665	0.141	-1.56529
0.0555	0	0.077	0	0.0985	-0.869497	0.12	-0.347766	0.1415	-1.56529
0.056	-0.173878	0.0775	0.173867	0.099	-0.869497	0.1205	-0.521665	0.142	-1.73927
0.0565	-0.173878	0.078	-0.173878	0.0995	-0.869497	0.121	-0.521665	0.1425	-1.73927
0.057	0	0.0785	0	0.1	-0.695576	0.1215	-0.347766	0.143	-1.73927
0.0575	-0.173878	0.079	-0.173878	0.1005	-0.695576	0.122	-0.347766	0.1435	-1.73927
0.058	-0.173878	0.0795	0	0.101	-0.695576	0.1225	-0.173878	0.144	-1.73927
0.0585	-0.173878	0.08	-0.347766	0.1015	-0.521665	0.123	-0.347766	0.1445	-1.73927
0.059	-0.173878	0.0805	-0.347766	0.102	-0.695576	0.1235	-0.173878	0.145	-1.73927
0.0595	0	0.081	-0.347766	0.1025	-0.347766	0.124	-0.347766	0.1455	-1.73927
0.06	0	0.0815	-0.347766	0.103	-0.521665	0.1245	-0.173878	0.146	-1.73927
0.0605	0	0.082	-0.347766	0.1035	-0.695576	0.125	0	0.1465	-1.39133
0.061	0	0.0825	-0.347766	0.104	-0.173878	0.1255	-0.173878	0.147	-1.56529
0.0615	-0.173878	0.083	-0.521665	0.1045	-0.521665	0.126	-0.173878	0.1475	-1.39133

Gauge28_6 Time msec	Gauge28_6 Stress MPa	Gauge28_6 Time msec	Gauge28_6 Stress MPa	Gauge28_6 Time msec	Gauge28_6 Stress MPa
0.148	-1.21737	0.1695	0	0.191	-13.7701
0.1485	-1.21737	0.17	0	0.1915	-13.5953
0.149	-1.04343	0.1705	0	0.192	-12.8965
0.1495	-0.869497	0.171	-0.173878	0.1925	-12.0232
0.15	-0.695576	0.1715	0	0.193	-11.3248
0.1505	-0.695576	0.172	-0.173878	0.1935	-11.1502
0.151	-0.695576	0.1725	0	0.194	-10.8011
0.1515	-0.521665	0.173	0	0.1945	-10.6266
0.152	-0.173878	0.1735	-0.173878	0.195	-10.6266
0.1525	0	0.174	-0.173878	0.1955	-10.2775
0.153	0	0.1745	-0.173878	0.196	-10.2775
0.1535	0.173867	0.175	-0.347766	0.1965	-10.2775
0.154	0.173867	0.1755	-0.347766	0.197	-10.6266
0.1545	0.347722	0.176	-0.347766	0.1975	-12.3725
0.155	0.347722	0.1765	-0.521665	0.198	-12.5472
0.1555	0.347722	0.177	-0.347766	0.1985	-15.518
0.156	0.173867	0.1775	0	0.199	-15.1683
0.1565	0.173867	0.178	0.347722	0.1995	-14.8187
0.157	0.173867	0.1785	0.869223	0.2	-15.3431
0.1575	0.173867	0.179	2.60685	0.2005	-16.0426
0.158	0	0.1795	5.38477	0.201	-16.7422
0.1585	0.173867	0.18	9.19984	0.2015	-17.6169
0.159	0.173867	0.1805	13.3557	0.202	-18.1419
0.1595	0.173867	0.181	17.1597	0.2025	-17.9669
0.16	0.173867	0.1815	17.3325	0.203	-18.842
0.1605	0.173867	0.182	13.8747	0.2035	-18.842
0.161	0.347722	0.1825	9.71967	0.204	-19.1922
0.1615	0.347722	0.183	5.90532	0.2045	-19.5423
0.162	0.347722	0.1835	2.60685	0.205	-19.5423
0.1625	0.347722	0.184	0	0.2055	-19.5423
0.163	0.173867	0.1845	-0.695576	0.206	-19.5423
0.1635	0.347722	0.185	-0.695576	0.2065	-19.5423
0.164	0.347722	0.1855	-0.695576	0.207	-19.5423
0.1645	0.347722	0.186	-1.91325	0.2075	-19.5423
0.165	0.347722	0.1865	-3.47963	0.208	-19.5423
0.1655	0.347722	0.187	-5.22109		
0.166	0.347722	0.1875	-6.26649		
0.1665	0	0.188	-8.0097		
0.167	0.173867	0.1885	-9.92849		
0.1675	0.173867	0.189	-11.1502		
0.168	0.173867	0.1895	-11.8486		
0.1685	0	0.19	-12.3725		
0.169	0.173867	0.1905	-13.0712		

Gauge29_1 Time msec	Gauge29_1 Stress MPa	Gauge29_1 Time msec	Gauge29_1 Stress MPa	Gauge29_1 Time msec	Gauge29_1 Stress MPa	Gauge29_1 Time msec	Gauge29_1 Stress MPa	Gauge29_1 Time msec	Gauge29_1 Stress MPa
-0.04	-85.1413	-0.0185	0	0.003	923.702	0.0245	109.625	0.046	0
-0.0395	-56.4825	-0.018	0	0.0035	882.501	0.025	55.369	0.0465	0
-0.039	-28.1021	-0.0175	0	0.004	801.735	0.0255	82.636	0.047	0
-0.0385	0	-0.017	0	0.0045	541.049	0.026	109.625	0.0475	-28.1021
-0.038	0	-0.0165	0	0.005	240.392	0.0265	136.335	0.048	-56.4825
-0.0375	0	-0.016	0	0.0055	188.92	0.027	55.369	0.0485	-28.1021
-0.037	0	-0.0155	0	0.006	136.335	0.0275	55.369	0.049	-28.1021
-0.0365	0	-0.015	0	0.0065	55.369	0.028	27.8237	0.0495	0
-0.036	-28.1021	-0.0145	0	0.007	-28.1021	0.0285	0	0.05	0
-0.0355	0	-0.014	0	0.0075	-172.788	0.029	-28.1021	0.0505	27.8237
-0.035	0	-0.0135	0	0.008	-232.611	0.0295	-28.1021	0.051	27.8237
-0.0345	-28.1021	-0.013	0	0.0085	-202.56	0.03	-28.1021	0.0515	27.8237
-0.034	0	-0.0125	0	0.009	-143.294	0.0305	-28.1021	0.052	27.8237
-0.0335	0	-0.012	0	0.0095	-56.4825	0.031	-28.1021	0.0525	27.8237
-0.033	-28.1021	-0.0115	0	0.01	0	0.0315	-56.4825	0.053	0
-0.0325	0	-0.011	0	0.0105	109.625	0.032	-28.1021	0.0535	55.369
-0.032	0	-0.0105	0	0.011	82.636	0.0325	0	0.054	55.369
-0.0315	0	-0.01	0	0.0115	55.369	0.033	27.8237	0.0545	27.8237
-0.031	0	-0.0095	0	0.012	136.335	0.0335	27.8237	0.055	27.8237
-0.0305	-56.4825	-0.009	0	0.0125	-28.1021	0.034	0	0.0555	27.8237
-0.03	0	-0.0085	0	0.013	27.8237	0.0345	0		
-0.0295	-28.1021	-0.008	0	0.0135	-56.4825	0.035	0		
-0.029	0	-0.0075	0	0.014	-85.1413	0.0355	0		
-0.0285	-28.1021	-0.007	0	0.0145	-56.4825	0.036	0		
-0.028	0	-0.0065	0	0.015	-56.4825	0.0365	0		
-0.0275	0	-0.006	0	0.0155	-56.4825	0.037	0		
-0.027	0	-0.0055	0	0.016	-28.1021	0.0375	27.8237		
-0.0265	0	-0.005	0	0.0165	-85.1413	0.038	27.8237		
-0.026	0	-0.0045	0	0.017	-56.4825	0.0385	27.8237		
-0.0255	0	-0.004	0	0.0175	-56.4825	0.039	27.8237		
-0.025	0	-0.0035	0	0.018	-56.4825	0.0395	27.8237		
-0.0245	0	-0.003	0	0.0185	-56.4825	0.04	27.8237		
-0.024	0	-0.0025	0	0.019	-28.1021	0.0405	27.8237		
-0.0235	0	-0.002	0	0.0195	-28.1021	0.041	0		
-0.023	0	-0.0015	0	0.02	0	0.0415	0		
-0.0225	0	-0.001	0	0.0205	0	0.042	0		
-0.022	0	-0.0005	0	0.021	27.8237	0.0425	-28.1021		
-0.0215	0	0	0	0.0215	55.369	0.043	0		
-0.021	0	0.0005	55.369	0.022	82.636	0.0435	0		
-0.0205	55.369	0.001	301.564	0.0225	109.625	0.044	27.8237		
-0.02	0	0.0015	412.029	0.023	109.625	0.0445	0		
-0.0195	0	0.002	762.259	0.0235	136.335	0.045	0		
-0.019	0	0.0025	1007.52	0.024	188.92	0.0455	-28.1021		

Gauge29_2 Time msec	Gauge29_2 Stress MPa	Gauge29_2 Time msec	Gauge29_2 Stress MPa	Gauge29_2 Time msec	Gauge29_2 Stress MPa	Gauge29_2 Time msec	Gauge29_2 Stress MPa	Gauge29_2 Time msec	Gauge29_2 Stress MPa
-0.038	-1.39656	-0.0165	0.349029	0.005	0.349029	0.0265	0.698015	0.048	0.349029
-0.0375	-1.39656	-0.016	0.349029	0.0055	0	0.027	0.698015	0.0485	1.39585
-0.037	-1.39656	-0.0155	0.349029	0.006	0	0.0275	0.349029	0.049	1.74471
-0.0365	-1.04735	-0.015	0.349029	0.0065	0.349029	0.028	0.349029	0.0495	1.04696
-0.036	-1.39656	-0.0145	0	0.007	-0.349073	0.0285	0	0.05	0.698015
-0.0355	-1.39656	-0.014	0	0.0075	-3.49271	0.029	0	0.0505	0.698015
-0.035	-1.39656	-0.0135	0	0.008	-2.44444	0.0295	0.349029	0.051	1.39585
-0.0345	-1.39656	-0.013	0	0.0085	7.32039	0.03	1.04696	0.0515	1.39585
-0.034	-1.04735	-0.0125	0.349029	0.009	7.6685	0.0305	0.698015	0.052	1.39585
-0.0335	-1.04735	-0.012	0.349029	0.0095	-0.349073	0.031	0.349029	0.0525	1.74471
-0.033	-1.39656	-0.0115	0	0.01	-5.94023	0.0315	-0.349073	0.053	1.74471
-0.0325	-1.74581	-0.011	0	0.0105	-4.54138	0.032	0.349029	0.0535	3.13968
-0.032	-2.0951	-0.0105	0	0.011	-0.698191	0.0325	1.04696	0.054	5.92752
-0.0315	3.13968	-0.01	0	0.0115	2.09352	0.033	0.698015	0.0545	11.4948
-0.031	2.09352	-0.0095	0	0.012	2.79101	0.0335	0.349029	0.055	19.8245
-0.0305	19.478	-0.009	0	0.0125	0	0.034	-3.968E-14	0.0555	24.6719
-0.03	-3.14324	-0.0085	0	0.013	-1.74581	0.0345	-0.349073	0.056	20.1711
-0.0295	-13.2957	-0.008	0	0.0135	-1.04735	0.035	0.698015	0.0565	9.75621
-0.029	-3.49271	-0.0075	0	0.014	-0.349073	0.0355	1.04696	0.057	5.23083
-0.0285	-2.0951	-0.007	0.349029	0.0145	2.09352	0.036	1.04696	0.0575	19.8245
-0.028	-1.39656	-0.0065	0.349029	0.015	1.39585	0.0365	0.349029	0.058	18.438
-0.0275	-0.698191	-0.006	0.349029	0.0155	0.349029	0.037	0	0.0585	7.32039
-0.027	-0.349073	-0.0055	-0.349073	0.016	-0.349073	0.0375	0.698015	0.059	8.01656
-0.0265	0.349029	-0.005	0.349029	0.0165	-1.39656	0.038	1.04696	0.0595	17.0508
-0.026	0.698015	-0.0045	0	0.017	0.349029	0.0385	1.04696	0.06	19.8245
-0.0255	0.698015	-0.004	0.349029	0.0175	1.74471	0.039	0.698015	0.0605	12.8848
-0.025	0	-0.0035	0	0.018	1.74471	0.0395	0.698015	0.061	7.6685
-0.0245	-0.349073	-0.003	0	0.0185	0	0.04	0.698015	0.0615	10.104
-0.024	0.349029	-0.0025	0	0.019	0	0.0405	0.698015	0.062	12.8848
-0.0235	0	-0.002	0.349029	0.0195	0.349029	0.041	0.698015	0.0625	12.1899
-0.023	0.349029	-0.0015	0	0.02	1.04696	0.0415	0.698015	0.063	8.71255
-0.0225	0.349029	-0.001	0	0.0205	1.04696	0.042	0.698015	0.0635	9.75621
-0.022	0	-0.0005	0	0.021	0.698015	0.0425	1.04696	0.064	10.7995
-0.0215	0.349029	0	0.349029	0.0215	0.349029	0.043	1.04696	0.0645	10.4518
-0.021	0.349029	0.0005	0.349029	0.022	0.349029	0.0435	0.698015	0.065	9.40837
-0.0205	0.349029	0.001	0.698015	0.0225	0.698015	0.044	0.698015	0.0655	9.40837
-0.02	0.349029	0.0015	0.349029	0.023	1.04696	0.0445	0.349029	0.066	10.4518
-0.0195	-0.349073	0.002	0.698015	0.0235	1.04696	0.045	0.698015	0.0665	10.7995
-0.019	0	0.0025	0.349029	0.024	0.698015	0.0455	1.04696	0.067	9.06048
-0.0185	0	0.003	0	0.0245	0.349029	0.046	1.04696	0.0675	7.32039
-0.018	0.349029	0.0035	0.698015	0.025	0.698015	0.0465	0.698015	0.068	6.27581
-0.0175	0.349029	0.004	0.698015	0.0255	0.698015	0.047	0.349029	0.0685	4.88241
-0.017	0.349029	0.0045	0.349029	0.026	0.698015	0.0475	0.349029	0.069	3.83691

Gauge29_2 Time msec	Gauge29_2 Stress MPa	Gauge29_2 Time msec	Gauge29_2 Stress MPa	Gauge29_2 Time msec	Gauge29_2 Stress MPa	Gauge29_2 Time msec	Gauge29_2 Stress MPa	Gauge29_2 Time msec	Gauge29_2 Stress MPa
0.0695	2.44228	0.091	-5.94023	0.1125	-2.79382	0.134	-3.14324	0.1555	2.09352
0.07	1.39585	0.0915	-5.59045	0.113	2.79101	0.1345	-2.44444	0.156	-2.44228
0.0705	0.698015	0.092	-5.24072	0.1135	-1.74581	0.135	-2.44444	0.1565	2.44228
0.071	-0.349073	0.0925	-5.24072	0.114	-2.79382	0.1355	-2.0951	0.157	-2.44228
0.0715	-1.39656	0.093	-4.89103	0.1145	-3.84222	0.136	-2.44444	0.1575	2.09352
0.072	-1.74581	0.0935	-4.89103	0.115	-2.44444	0.1365	-2.0951	0.158	3.13968
0.0725	-0.698191	0.094	-5.24072	0.1155	-2.44444	0.137	-2.44444	0.1585	2.09352
0.073	-0.349073	0.0945	-5.24072	0.116	-1.74581	0.1375	-2.44444	0.159	1.74471
0.0735	-1.74581	0.095	-5.94023	0.1165	-3.14324	0.138	-1.39656	0.1595	3.13968
0.074	-1.74581	0.0955	-6.29005	0.117	-0.349073	0.1385	-1.74581	0.16	2.79101
0.0745	-1.39656	0.096	-6.63991	0.1175	-0.349073	0.139	-1.74581	0.1605	5.23083
0.075	-0.349073	0.0965	-7.33977	0.118	-2.0951	0.1395	-2.79382	0.161	2.44228
0.0755	0.349029	0.097	-6.63991	0.1185	-1.39656	0.14	-3.14324	0.1615	2.09352
0.076	1.04696	0.0975	-5.94023	0.119	-2.0951	0.1405	-2.0951	0.162	0.698015
0.0765	0.349029	0.098	-6.29005	0.1195	0	0.141	-2.0951	0.1625	3.9683E-14
0.077	0	0.0985	-6.98982	0.12	-1.39656	0.1415	-1.74581		
0.0775	-1.39656	0.099	-7.33977	0.1205	-0.698191	0.142	-2.0951		
0.078	-1.74581	0.0995	-7.68977	0.121	-1.39656	0.1425	-3.14324		
0.0785	-2.0951	0.1	-7.33977	0.1215	-2.0951	0.143	-3.49271		
0.079	-3.49271	0.1005	-7.33977	0.122	-2.44444	0.1435	-1.39656		
0.0795	-4.19178	0.101	-6.63991	0.1225	-1.04735	0.144	-0.698191		
0.08	-4.89103	0.1015	-6.98982	0.123	-1.04735	0.1445	-2.44444		
0.0805	-5.59045	0.102	-6.63991	0.1235	-0.349073	0.145	-1.04735		
0.081	-5.24072	0.1025	-6.63991	0.124	-0.349073	0.1455	-1.74581		
0.0815	-4.89103	0.103	-6.63991	0.1245	-1.39656	0.146	-2.0951		
0.082	-4.54138	0.1035	-6.29005	0.125	-1.04735	0.1465	-1.74581		
0.0825	-4.89103	0.104	-6.29005	0.1255	-1.74581	0.147	-2.0951		
0.083	-4.54138	0.1045	-5.59045	0.126	-1.74581	0.1475	9.40837		
0.0835	-5.24072	0.105	-5.24072	0.1265	-1.74581	0.148	-3.49271		
0.084	-5.24072	0.1055	-3.84222	0.127	-0.698191	0.1485	-1.39656		
0.0845	-4.54138	0.106	-3.84222	0.1275	-2.44444	0.149	-0.698191		
0.085	-4.19178	0.1065	-3.49271	0.128	-1.74581	0.1495	-0.698191		
0.0855	-3.49271	0.107	-3.14324	0.1285	-2.44444	0.15	0		
0.086	-3.49271	0.1075	-2.79382	0.129	-2.44444	0.1505	0		
0.0865	-3.84222	0.108	-2.44444	0.1295	-3.14324	0.151	-0.698191		
0.087	-4.54138	0.1085	-2.0951	0.13	-3.84222	0.1515	-0.349073		
0.0875	-5.24072	0.109	-1.74581	0.1305	-3.49271	0.152	-0.698191		
0.088	-6.29005	0.1095	-2.44444	0.131	-1.74581	0.1525	-1.04735		
0.0885	-5.94023	0.11	-1.74581	0.1315	-3.49271	0.153	0.349029		
0.089	-5.94023	0.1105	-2.79382	0.132	-1.74581	0.1535	-1.04735		
0.0895	-5.59045	0.111	-2.0951	0.1325	-3.49271	0.154	-0.349073		
0.09	-5.59045	0.1115	-2.0951	0.133	-3.14324	0.1545	1.39585		
0.0905	-6.29005	0.112	-2.79382	0.1335	-2.79382	0.155	1.39585		

Gauge29_3 Time msec	Gauge29_3 Stress MPa	Gauge29_3 Time msec	Gauge29_3 Stress MPa	Gauge29_3 Time msec	Gauge29_3 Stress MPa	Gauge29_3 Time msec	Gauge29_3 Stress MPa	Gauge29_3 Time msec	Gauge29_3 Stress MPa
-0.04	-1.02803	-0.0185	0	0.003	0	0.0245	0	0.046	0
-0.0395	-1.02803	-0.018	0	0.0035	0	0.025	0	0.0465	0
-0.039	-1.37079	-0.0175	0	0.004	0	0.0255	0	0.047	0.34259
-0.0385	-1.37079	-0.017	0	0.0045	-0.342633	0.026	-0.685309	0.0475	0.34259
-0.038	-1.37079	-0.0165	-0.342633	0.005	0	0.0265	0	0.048	0.34259
-0.0375	-1.37079	-0.016	-0.685309	0.0055	-0.342633	0.027	0	0.0485	0.34259
-0.037	-1.7136	-0.0155	-0.342633	0.006	-0.342633	0.0275	0	0.049	0.34259
-0.0365	-1.37079	-0.015	-0.342633	0.0065	-0.342633	0.028	0	0.0495	0.34259
-0.036	-1.37079	-0.0145	0	0.007	-0.342633	0.0285	0	0.05	0.34259
-0.0355	-1.02803	-0.014	0	0.0075	-0.342633	0.029	-0.342633	0.0505	0.34259
-0.035	-1.02803	-0.0135	0	0.008	-0.685309	0.0295	0	0.051	0.685136
-0.0345	-1.37079	-0.013	0	0.0085	-0.342633	0.03	0	0.0515	0.685136
-0.034	-1.02803	-0.0125	0.34259	0.009	-0.342633	0.0305	-0.342633	0.052	1.3701
-0.0335	-1.37079	-0.012	-0.342633	0.0095	-0.342633	0.031	-0.685309	0.0525	3.08176
-0.033	-1.02803	-0.0115	-0.342633	0.01	-0.342633	0.0315	-0.342633	0.053	6.8436
-0.0325	-1.37079	-0.011	0	0.0105	-0.342633	0.032	-0.685309	0.0535	13.329
-0.032	-1.02803	-0.0105	-0.342633	0.011	-0.342633	0.0325	-0.342633	0.054	18.4381
-0.0315	-1.37079	-0.01	-0.342633	0.0115	0	0.033	-0.685309	0.0545	13.329
-0.031	-1.37079	-0.0095	0	0.012	-0.685309	0.0335	-0.685309	0.055	4.4503
-0.0305	-3.08525	-0.009	-0.342633	0.0125	-0.342633	0.034	-0.685309	0.0555	-2.39934
-0.03	-23.7429	-0.0085	-0.342633	0.013	-0.342633	0.0345	-1.02803	0.056	-5.83063
-0.0295	-1.02803	-0.008	-0.342633	0.0135	-0.342633	0.035	-0.685309	0.0565	-4.45759
-0.029	17.0766	-0.0075	-0.342633	0.014	-0.342633	0.0355	-1.02803	0.057	-4.11444
-0.0285	5.81816	-0.007	-0.342633	0.0145	-0.342633	0.036	-1.02803	0.0575	-3.08525
-0.028	1.3701	-0.0065	-0.342633	0.015	-0.342633	0.0365	-1.02803	0.058	-4.11444
-0.0275	0.685136	-0.006	-0.342633	0.0155	-0.342633	0.037	-1.02803	0.0585	-2.74227
-0.027	-7.79E-14	-0.0055	-0.342633	0.016	-0.342633	0.0375	-1.02803	0.059	-1.37079
-0.0265	-0.342633	-0.005	-0.342633	0.0165	-0.342633	0.038	-1.02803	0.0595	-0.685309
-0.026	0	-0.0045	-0.342633	0.017	-0.342633	0.0385	-1.02803	0.06	-0.342633
-0.0255	0	-0.004	-0.342633	0.0175	-0.342633	0.039	-1.02803	0.0605	0
-0.025	-0.342633	-0.0035	-0.342633	0.018	-0.342633	0.0395	-1.02803	0.061	0.34259
-0.0245	-0.685309	-0.003	-0.342633	0.0185	0	0.04	-1.02803	0.0615	0
-0.024	-0.342633	-0.0025	-0.342633	0.019	0	0.0405	-1.02803	0.062	-0.342633
-0.0235	-0.342633	-0.002	-0.342633	0.0195	0	0.041	-1.02803	0.0625	-1.02803
-0.023	-0.342633	-0.0015	-0.342633	0.02	0	0.0415	-0.685309	0.063	-3.08525
-0.0225	-0.342633	-0.001	-0.342633	0.0205	0	0.042	-0.685309	0.0635	-3.77134
-0.022	0	-0.0005	-0.685309	0.021	0	0.0425	-0.685309	0.064	-3.42827
-0.0215	-0.342633	0	-0.342633	0.0215	0	0.043	-0.342633	0.0645	-2.05644
-0.021	-0.342633	0.0005	-0.342633	0.022	0	0.0435	-0.342633	0.065	-2.74227
-0.0205	-0.342633	0.001	-0.685309	0.0225	-0.342633	0.044	-0.342633	0.0655	-4.11444
-0.02	0	0.0015	-0.342633	0.023	0	0.0445	-0.342633	0.066	-5.4873
-0.0195	0	0.002	0	0.0235	0	0.045	-0.342633	0.0665	-6.5174
-0.019	0	0.0025	0	0.024	0	0.0455	0	0.067	-7.54789

Gauge29_3 Time msec	Gauge29_3 Stress MPa	Gauge29_3 Time msec	Gauge29_3 Stress MPa	Gauge29_3 Time msec	Gauge29_3 Stress MPa	Gauge29_4 Time msec	Gauge29_4 Stress MPa	Gauge29_4 Time msec	Gauge29_4 Stress MPa
0.0675	-9.26623	0.089	-39.6856	0.1105	-41.424	-0.0385	-2.29177	-0.017	0
0.068	-10.9857	0.0895	-40.0332	0.111	-40.7285	-0.038	-2.2223	-0.0165	0
0.0685	-13.739	0.09	-40.3808	0.1115	-40.3808	-0.0375	-2.08335	-0.016	0
0.069	-15.1167	0.0905	-40.3808	0.112	-40.7285	-0.037	-2.29177	-0.0155	0.347072
0.0695	-15.8058	0.091	-40.0332	0.1125	-41.424	-0.0365	-2.43073	-0.015	0
0.07	-16.1504	0.0915	-39.338	0.113	-42.1196	-0.036	-2.2223	-0.0145	0
0.0705	-17.1845	0.092	-39.338	0.1135	-42.8155	-0.0355	-2.08335	-0.014	0
0.071	-17.5293	0.0925	-39.6856	0.114	-42.4675	-0.035	-2.29177	-0.0135	0
0.0715	-17.8741	0.093	-40.3808	0.1145	-40.7285	-0.0345	-2.43073	-0.013	0.138834
0.072	-17.8741	0.0935	-40.7285	0.115	-38.6431	-0.034	-2.2223	-0.0125	-0.138841
0.0725	-18.219	0.094	-41.424	0.1155	-37.9483	-0.0335	-2.29177	-0.012	0.347072
0.073	-19.2539	0.0945	-41.424	0.116	-39.6856	-0.033	-2.43073	-0.0115	0.347072
0.0735	-20.2892	0.095	-41.424	0.1165	-43.8596	-0.0325	-2.2223	-0.011	0.138834
0.074	-20.6343	0.0955	-41.424			-0.032	-2.08335	-0.0105	-0.347116
0.0745	-20.9796	0.096	-41.0762			-0.0315	-2.29177	-0.01	0
0.075	-22.0155	0.0965	-41.424			-0.031	-2.43073	-0.0095	0
0.0755	-23.3973	0.097	-41.7718			-0.0305	-2.2223	-0.009	0
0.076	-25.4714	0.0975	-42.4675			-0.03	-2.91713	-0.0085	0
0.0765	-27.547	0.098	-43.1635			-0.0295	-5.69822	-0.008	0
0.077	-28.9316	0.0985	-43.5115			-0.029	-3.47313	-0.0075	0.347072
0.0775	-29.9705	0.099	-43.8596			-0.0285	-2.43073	-0.007	0
0.078	-30.6633	0.0995	-44.2077			-0.028	2.08178	-0.0065	0
0.0785	-32.3961	0.1	-44.904			-0.0275	3.05274	-0.006	0
0.079	-34.1299	0.1005	-44.2077			-0.027	0.8329	-0.0055	-0.208264
0.0795	-35.1708	0.101	-44.2077			-0.0265	0.416481	-0.005	-0.138841
0.08	-35.8649	0.1015	-43.8596			-0.026	-	-0.0045	0.138834
0.0805	-36.212	0.102	-43.8596			-0.0255	0.347072	-0.004	0.208249
0.081	-36.212	0.1025	-43.5115			-0.025	0.138834	-0.0035	0.138834
0.0815	-36.5592	0.103	-43.8596			-0.0245	0.347072	-0.003	0
0.082	-36.5592	0.1035	-43.5115			-0.024	0.138834	-0.0025	0
0.0825	-36.9064	0.104	-44.2077			-0.0235	0	-0.002	0
0.083	-36.9064	0.1045	-43.8596			-0.023	0	-0.0015	0
0.0835	-37.2536	0.105	-44.2077			-0.0225	0.138834	-0.001	0
0.084	-37.6009	0.1055	-43.8596			-0.022	0	-0.0005	0
0.0845	-37.9483	0.106	-43.5115			-0.0215	0	0	0
0.085	-37.9483	0.1065	-43.8596			-0.021	0	0.0005	0
0.0855	-38.2956	0.107	-43.8596			-0.0205	0	0.001	0
0.086	-38.9905	0.1075	-43.8596			-0.02	0	0.0015	0
0.0865	-38.6431	0.108	-43.8596			-0.0195	0	0.002	0
0.087	-38.6431	0.1085	-44.5558			-0.019	0	0.0025	0
0.0875	-38.6431	0.109	-44.2077			-0.0185	0	0.003	0
0.088	-38.6431	0.1095	-43.5115			-0.018	0	0.0035	0
0.0885	-38.9905	0.11	-42.4675			-0.0175	0	0.004	0

Gauge29_4 Time msec	Gauge29_4 Stress MPa	Gauge29_4 Time msec	Gauge29_4 Stress MPa	Gauge29_4 Time msec	Gauge29_4 Stress MPa	Gauge29_4 Time msec	Gauge29_4 Stress MPa	Gauge29_4 Time msec	Gauge29_4 Stress MPa
0.0045	0.208249	0.026	0	0.0475	-0.347116	0.069	0	0.0905	0
0.005	0.138834	0.0265	0	0.048	-0.347116	0.0695	-0.208264	0.091	0
0.0055	0.208249	0.027	0	0.0485	-0.694276	0.07	-0.138841	0.0915	0
0.006	0.138834	0.0275	0	0.049	-0.347116	0.0705	0	0.092	0.347072
0.0065	0	0.028	0	0.0495	-0.694276	0.071	0.347072	0.0925	0.347072
0.007	-0.347116	0.0285	0	0.05	-0.555407	0.0715	0	0.093	0.347072
0.0075	0.208249	0.029	0	0.0505	-0.485975	0.072	0.347072	0.0935	0.347072
0.008	0.347072	0.0295	0.347072	0.051	-0.694276	0.0725	0	0.094	0.347072
0.0085	-0.208264	0.03	0	0.0515	-0.347116	0.073	-0.208264	0.0945	0.347072
0.009	0	0.0305	0	0.052	-0.347116	0.0735	-0.138841	0.095	0.347072
0.0095	0.208249	0.031	0	0.0525	-0.347116	0.074	0.138834	0.0955	0.347072
0.01	0.138834	0.0315	0.347072	0.053	-0.694276	0.0745	0	0.096	0.347072
0.0105	0	0.032	0	0.0535	-0.555407	0.075	0	0.0965	0.347072
0.011	0	0.0325	0	0.054	-0.694276	0.0755	0	0.097	0
0.0115	0	0.033	0	0.0545	-0.694276	0.076	0.347072	0.0975	0
0.012	0.208249	0.0335	0	0.055	-0.694276	0.0765	0	0.098	0
0.0125	0.138834	0.034	0	0.0555	-1.04148	0.077	0.347072	0.0985	0
0.013	0	0.0345	0	0.056	-0.694276	0.0775	0.347072	0.099	0
0.0135	0	0.035	0	0.0565	-0.694276	0.078	0.347072	0.0995	0.347072
0.014	0	0.0355	0	0.057	-0.694276	0.0785	0.555295	0.1	0.138834
0.0145	0	0.036	0	0.0575	-0.902592	0.079	0.485889	0.1005	0.208249
0.015	0	0.0365	-0.208264	0.058	-0.485975	0.0795	0.347072	0.101	0.138834
0.0155	0	0.037	-0.694276	0.0585	-0.555407	0.08	0.347072	0.1015	0
0.016	0.347072	0.0375	-0.694276	0.059	-1.04148	0.0805	0.347072	0.102	0.208249
0.0165	0	0.038	-0.347116	0.0595	-1.04148	0.081	0.347072	0.1025	0.347072
0.017	0	0.0385	-0.694276	0.06	-0.485975	0.0815	0.347072	0.103	0.138834
0.0175	0	0.039	-0.694276	0.0605	-0.347116	0.082	0.347072	0.1035	0.347072
0.018	0.347072	0.0395	-0.694276	0.061	-0.555407	0.0825	0.347072	0.104	0.347072
0.0185	0.347072	0.04	-0.694276	0.0615	-0.694276	0.083	0	0.1045	0.347072
0.019	0	0.0405	-0.694276	0.062	-0.485975	0.0835	0	0.105	0.347072
0.0195	0.347072	0.041	-0.694276	0.0625	-0.347116	0.084	0	0.1055	0.694101
0.02	0	0.0415	-0.694276	0.063	-0.347116	0.0845	0	0.106	1.38803
0.0205	0	0.042	-0.694276	0.0635	-0.555407	0.085	0	0.1065	2.42859
0.021	0.347072	0.0425	-0.694276	0.064	-0.694276	0.0855	0	0.107	4.50853
0.0215	0	0.043	-0.694276	0.0645	-0.485975	0.086	-0.208264	0.1075	7.27934
0.022	0.347072	0.0435	-0.694276	0.065	-0.347116	0.0865	-0.485975	0.108	10.7389
0.0225	0.347072	0.044	-0.694276	0.0655	-0.555407	0.087	0	0.1085	13.5034
0.023	0.347072	0.0445	-0.694276	0.066	-0.485975	0.0875	-0.347116	0.109	15.0918
0.0235	0.347072	0.045	-0.694276	0.0665	-0.555407	0.088	0	0.1095	13.2962
0.024	0.347072	0.0455	-0.694276	0.067	-0.485975	0.0885	0	0.11	11.0846
0.0245	0	0.046	-0.833152	0.0675	-0.347116	0.089	0	0.1105	8.6637
0.025	0.347072	0.0465	-0.555407	0.068	-0.555407	0.0895	0	0.111	6.9314
0.0255	0	0.047	-0.485975	0.0685	-0.138841	0.09	0	0.1115	5.2015

Gauge29_4 Time msec	Gauge29_4 Stress MPa	Gauge29_4 Time msec	Gauge29_4 Stress MPa	Gauge29_4 Time msec	Gauge29_4 Stress MPa	Gauge29_4 Time msec	Gauge29_4 Stress MPa	Gauge29_5 Time msec	Gauge29_5 Stress MPa
0.112	2.42859	0.1335	-1.42676	0.155	-9.52679	0.1765	-25.1041	-0.04	-2.79906
0.1125	0	0.134	-13.9187	0.1555	-11.8265	0.177	-25.1041	-0.0395	-2.79908
0.113	-1.73602	0.1345	-13.7792	0.156	-12.3842	0.1775	-25.1041	-0.039	-2.79908
0.1135	-3.82068	0.135	-13.7094	0.1565	-12.3145	0.178	-24.7538	-0.0385	-2.79906
0.114	-5.90692	0.1355	-13.2211	0.157	-12.5237	0.1785	-24.7538	-0.038	-2.79908
0.1145	-6.95062	0.136	-13.2211	0.1575	-13.2211			-0.0375	-2.79908
0.115	-7.99473	0.1365	-12.5237	0.158	-14.4769			-0.037	-2.79908
0.1155	-8.69101	0.137	-12.1751	0.1585	-15.6635			-0.0365	-3.14916
0.116	-9.73577	0.1375	-11.8265	0.159	-15.8031			-0.036	-2.79908
0.1165	-9.8751	0.138	-11.4779	0.1595	-16.3617			-0.0355	-2.79908
0.117	-10.0841	0.1385	-10.7809	0.16	-17.2696			-0.035	-2.79908
0.1175	-10.7809	0.139	-10.0841	0.1605	-17.7586			-0.0345	-2.79908
0.118	-10.6415	0.1395	-9.73577	0.161	-18.108			-0.034	-2.79906
0.1185	-10.5719	0.14	-9.03922	0.1615	-19.1563			-0.0335	-2.79906
0.119	-10.0841	0.1405	-9.03922	0.162	-19.5058			-0.033	-2.79908
0.1195	-9.73577	0.141	-8.69101	0.1625	-20.5546			-0.0325	-2.79908
0.12	-9.24817	0.1415	-9.38747	0.163	-21.0442			-0.032	-2.79908
0.1205	-8.69101	0.142	-9.73577	0.1635	-21.6038			-0.0315	-2.79908
0.121	-8.13397	0.1425	-10.0841	0.164	-21.8137			-0.031	-2.79908
0.1215	-8.55174	0.143	-10.4325	0.1645	-23.3534			-0.0305	-2.44904
0.122	-9.03922	0.1435	-11.1294	0.165	-23.0034			-0.03	-3.84946
0.1225	-9.03922	0.144	-11.4779	0.1655	-24.4037			-0.0295	-2.79908
0.123	-9.03922	0.1445	-11.8265	0.166	-25.8046			-0.029	-3.14916
0.1235	-9.38747	0.145	-12.1751	0.1665	-23.0034			-0.0285	-15.0782
0.124	-10.0841	0.1455	-12.7329	0.167	-24.8939			-0.028	-2.79908
0.1245	-10.7809	0.146	-13.3606	0.1675	-25.3142			-0.0275	12.2128
0.125	-11.1294	0.1465	-13.2211	0.168	-26.155			-0.027	0.349667
0.1255	-11.4779	0.147	-13.7792	0.1685	-25.8046			-0.0265	0.699329
0.126	-11.8265	0.1475	-14.0583	0.169	-25.8046			-0.026	0.349687
0.1265	-12.1751	0.148	-14.4769	0.1695	-24.4037			-0.0255	0.699329
0.127	-12.8724	0.1485	-14.7561	0.17	-24.7538			-0.025	0
0.1275	-13.2211	0.149	-15.3144	0.1705	-25.4543			-0.0245	0.349687
0.128	-13.2211	0.1495	-15.5239	0.171	-25.8046			-0.024	0.349667
0.1285	-13.2211	0.15	-16.0126	0.1715	-24.7538			-0.0235	0
0.129	-13.5699	0.1505	-15.6635	0.172	-25.8046			-0.023	0
0.1295	-13.2211	0.151	-15.4541	0.1725	-24.4037			-0.0225	0
0.13	-13.5699	0.1515	-15.1748	0.173	-25.4543			-0.022	0
0.1305	-13.9187	0.152	-14.7561	0.1735	-24.7538			-0.0215	0
0.131	-14.2676	0.1525	-14.6165	0.174	-25.8046			-0.021	0
0.1315	-14.6165	0.153	-14.2676	0.1745	-23.8435			-0.0205	0
0.132	-15.3144	0.1535	-14.128	0.175	-25.3142			-0.02	0
0.1325	-15.3144	0.154	-13.9187	0.1755	-25.1041			-0.0195	0
0.133	-14.9655	0.1545	-13.9187	0.176	-24.7538			-0.019	-0.349731

Gauge29_5 Time msec	Gauge29_5 Stress MPa	Gauge29_5 Time msec	Gauge29_5 Stress MPa	Gauge29_5 Time msec	Gauge29_5 Stress MPa	Gauge29_5 Time msec	Gauge29_5 Stress MPa	Gauge29_5 Time msec	Gauge29_5 Stress MPa
-0.0185	0	0.003	0	0.0245	0	0.046	0.699329	0.0675	0.699329
-0.018	0	0.0035	0	0.025	0	0.0465	0.699329	0.068	0.699329
-0.0175	0	0.004	0	0.0255	0	0.047	0.699329	0.0685	0.699329
-0.017	-0.349731	0.0045	0	0.026	0	0.0475	0.699329	0.069	0.699329
-0.0165	0	0.005	0	0.0265	0	0.048	0.699329	0.0695	0.699329
-0.016	0	0.0055	0	0.027	0	0.0485	0.699329	0.07	0.349687
-0.0155	0	0.006	0	0.0275	0	0.049	0.699329	0.0705	0.699329
-0.015	0	0.0065	0	0.028	0	0.0495	0.699329	0.071	1.04893
-0.0145	0	0.007	0	0.0285	0	0.05	0.699329	0.0715	0.699329
-0.014	0	0.0075	-0.349731	0.029	0	0.0505	0.699329	0.072	0.699329
-0.0135	0	0.008	0	0.0295	0	0.051	0.699329	0.0725	0.699329
-0.013	0	0.0085	0	0.03	0	0.0515	0.699329	0.073	0.349667
-0.0125	0	0.009	-0.349731	0.0305	0	0.052	0.699329	0.0735	0.699329
-0.012	0	0.0095	0	0.031	0	0.0525	0.699329	0.074	0.699329
-0.0115	0	0.01	-0.349731	0.0315	0.349687	0.053	0.699329	0.0745	0.349687
-0.011	0	0.0105	0	0.032	0	0.0535	0.699329	0.075	0.699329
-0.0105	-0.349731	0.011	-0.349731	0.0325	0	0.054	0.699329	0.0755	0.699329
-0.01	-0.349731	0.0115	0	0.033	0	0.0545	0.699329	0.076	0.699329
-0.0095	-0.349731	0.012	0	0.0335	0.349687	0.055	0.699329	0.0765	0.349687
-0.009	0	0.0125	-0.349731	0.034	0.349687	0.0555	0.349687	0.077	0
-0.0085	0	0.013	0	0.0345	0.349687	0.056	0.699329	0.0775	0.699329
-0.008	0	0.0135	0	0.035	0.349687	0.0565	0.349687	0.078	0.349687
-0.0075	-0.349731	0.014	-0.349731	0.0355	0.349687	0.057	0.349687	0.0785	0
-0.007	0	0.0145	0.349687	0.036	0.349687	0.0575	0.349687	0.079	0.349687
-0.0065	0	0.015	0	0.0365	0.699329	0.058	0.699329	0.0795	0.699329
-0.006	0	0.0155	-0.349731	0.037	0.349687	0.0585	0.699329	0.08	0
-0.0055	0	0.016	-0.349731	0.0375	0.699329	0.059	0.699329	0.0805	0
-0.005	0	0.0165	0	0.038	0.699329	0.0595	0.699329	0.081	0
-0.0045	0	0.017	0	0.0385	0.699329	0.06	0.699329	0.0815	0
-0.004	0	0.0175	-0.349731	0.039	0.699329	0.0605	0.699329	0.082	0
-0.0035	0	0.018	0	0.0395	0.699329	0.061	0.699329	0.0825	0
-0.003	0	0.0185	0	0.04	0.699329	0.0615	0.349687	0.083	0
-0.0025	-0.349731	0.019	0	0.0405	0.699329	0.062	0.349687	0.0835	0
-0.002	0	0.0195	0	0.041	0.699329	0.0625	0.349687	0.084	0
-0.0015	0	0.02	0	0.0415	0.699329	0.063	0.699329	0.0845	-0.349731
-0.001	0	0.0205	0	0.042	0.699329	0.0635	0.349687	0.085	0
-0.0005	0	0.021	0	0.0425	0.699329	0.064	0.349687	0.0855	0
0	0	0.0215	0	0.043	0.699329	0.0645	0.699329	0.086	0
0.0005	0	0.022	0	0.0435	0.699329	0.065	0.349687	0.0865	0
0.001	0	0.0225	0	0.044	0.699329	0.0655	0.699329	0.087	0
0.0015	0	0.023	0	0.0445	0.699329	0.066	0.699329	0.0875	0
0.002	0	0.0235	0	0.045	0.699329	0.0665	0.349687	0.088	0
0.0025	0.349687	0.024	0	0.0455	0.699329	0.067	0.699329	0.0885	0.349687

Gauge29_5 Time msec	Gauge29_5 Stress MPa	Gauge29_5 Time msec	Gauge29_5 Stress MPa	Gauge29_5 Time msec	Gauge29_5 Stress MPa	Gauge29_5 Time msec	Gauge29_5 Stress MPa	Gauge29_5 Time msec	Gauge29_5 Stress MPa
0.089	0.349687	0.1105	8.03165	0.132	-3.84946	0.1535	-3.84946	0.175	-12.9694
0.0895	0.349687	0.111	9.42609	0.1325	-4.19968	0.154	-4.19968	0.1755	-12.9694
0.09	0.349687	0.1115	10.123	0.133	-4.54994	0.1545	-4.19968	0.176	-15.4298
0.0905	0.349687	0.112	9.42609	0.1335	-4.19968	0.155	-4.90024	0.1765	-14.7266
0.091	0.349687	0.1125	9.07754	0.134	-4.54994	0.1555	-5.25059	0.177	-15.4298
0.0915	0.349687	0.113	8.38033	0.1345	-4.90024	0.156	-5.25059	0.1775	-14.7266
0.092	0.349687	0.1135	7.33417	0.135	-4.54994	0.1565	-5.95141	0.178	-15.4298
0.0925	0.699329	0.114	5.93869	0.1355	-4.90024	0.157	-5.60098	0.1785	-14.3751
0.093	0.699329	0.1145	4.89161	0.136	-4.54994	0.1575	-5.60098	0.179	-11.2132
0.0935	0.699329	0.115	5.24068	0.1365	-4.54994	0.158	-5.95141	0.1795	-14.0236
0.094	0.699329	0.1155	5.24068	0.137	-4.19968	0.1585	-5.95141	0.18	-15.7815
0.0945	0.699329	0.116	4.89161	0.1375	-3.84946	0.159	-6.65242	0.1805	-17.1886
0.095	0.699329	0.1165	4.89161	0.138	-3.14916	0.1595	-7.00298	0.181	-8.05495
0.0955	0.699329	0.117	4.89161	0.1385	-3.14916	0.16	-7.70425	0.1815	-16.1332
0.096	0.699329	0.1175	4.19333	0.139	-3.14916	0.1605	-8.75648	0.182	-15.7815
0.0965	0.699329	0.118	3.49489	0.1395	-3.14916	0.161	-9.10731	0.1825	-16.8368
0.097	0.699329	0.1185	3.1456	0.14	-3.14916	0.1615	-9.10731	0.183	-16.1332
0.0975	0.699329	0.119	3.1456	0.1405	-2.79908	0.162	-9.10731	0.1835	-17.1886
0.098	0.699329	0.1195	3.1456	0.141	-2.79908	0.1625	-9.10731	0.184	-14.0236
0.0985	0.349687	0.12	2.79626	0.1415	-2.79908	0.163	-9.80911	0.1845	-16.4849
0.099	0.349687	0.1205	2.79626	0.142	-2.44904	0.1635	-9.80911	0.185	-18.2444
0.0995	0.349687	0.121	2.44688	0.1425	-2.44904	0.164	-9.80911	0.1855	-17.8924
0.1	0.349687	0.1215	1.74799	0.143	-2.44904	0.1645	-8.75648	0.186	-16.4849
0.1005	0.699329	0.122	1.74799	0.1435	-2.79908	0.165	-8.75648	0.1865	-17.1886
0.101	0.699329	0.1225	1.39848	0.144	-2.79908	0.1655	-8.75648	0.187	-16.8368
0.1015	0.699329	0.123	1.74799	0.1445	-2.09905	0.166	-9.10731	0.1875	-18.2444
0.102	0.699329	0.1235	1.74799	0.145	-1.74909	0.1665	-9.45819	0.188	-17.5405
0.1025	0.699329	0.124	1.04893	0.1455	-2.09905	0.167	-9.45819	0.1885	-17.5405
0.103	0.699329	0.1245	0.349687	0.146	-1.74909	0.1675	-9.80911	0.189	-17.5405
0.1035	0.699329	0.125	0.349687	0.1465	-2.09905	0.168	-10.1601	0.1895	-17.5405
0.104	0.699329	0.1255	0	0.147	-2.09905	0.1685	-10.5111	0.19	-14.7266
0.1045	0.699329	0.126	-0.349731	0.1475	-2.09905	0.169	-10.5111	0.1905	-13.3207
0.105	0.699329	0.1265	-0.699506	0.148	-2.09905	0.1695	-10.8621	0.191	-17.5405
0.1055	0.699329	0.127	-1.39919	0.1485	-2.09905	0.17	-10.8621	0.1915	-17.8924
0.106	1.04893	0.1275	-2.09905	0.149	-2.79908	0.1705	-11.5644	0.192	-20.3572
0.1065	0.699329	0.128	-2.79908	0.1495	-2.79908	0.171	-12.2668	0.1925	-18.2444
0.107	1.39848	0.1285	-3.49929	0.15	-3.14916	0.1715	-12.6181	0.193	-17.5405
0.1075	1.74799	0.129	-3.49929	0.1505	-3.84946	0.172	-13.3207	0.1935	-18.5964
0.108	2.09746	0.1295	-4.54994	0.151	-4.19968	0.1725	-14.0236	0.194	-18.2444
0.1085	3.49489	0.13	-4.19968	0.1515	-3.84946	0.173	-12.6181	0.1945	-11.5644
0.109	4.54249	0.1305	-3.84946	0.152	-4.19968	0.1735	-17.1886	0.195	-16.8368
0.1095	6.63652	0.131	-3.84946	0.1525	-4.19968	0.174	-15.4298	0.1955	-19.3006
0.11	7.33417	0.1315	-3.84946	0.153	-3.14916	0.1745	-12.9694	0.196	-18.9488

Gauge29_5 Time msec	Gauge29_5 Stress MPa	Gauge29_6 Time msec	Gauge29_6 Stress MPa	Gauge29_6 Time msec	Gauge29_6 Stress MPa	Gauge29_6 Time msec	Gauge29_6 Stress MPa	Gauge29_6 Time msec	Gauge29_6 Stress MPa	Gauge29_6 Time msec	Gauge29_6 Stress MPa
0.1965	-19.3006	0.1105	0.51104	0.132	0.340704	0.1535	0.340704	0.175	-2.21562	0.1965	-6.48153
0.197	-19.3006	0.111	0.51104	0.1325	0.340704	0.154	0.681365	0.1755	-2.72718	0.197	-6.48153
0.1975	-20.0049	0.1115	0.51104	0.133	0.340704	0.1545	0.340704	0.176	-3.4094	0.1975	-6.82309
0.198	-19.3006	0.112	0.340704	0.1335	0.340704	0.155	0.340704	0.1765	-3.75058	0.198	-7.33551
0.1985	-22.119	0.1125	0.51104	0.134	0.340704	0.1555	0.340704	0.177	-3.75058	0.1985	-8.01889
0.199	-17.5405	0.113	0.340704	0.1345	0.51104	0.156	0.340704	0.1775	-4.26242	0.199	-8.36665
0.1995	-17.1886	0.1135	0.170357	0.135	0.51104	0.1565	0.340704	0.178	-4.43306	0.1995	-8.53154
0.2	-21.0618	0.114	0.340704	0.1355	0.340704	0.157	0.681365	0.1785	-4.6037	0.2	-9.04429
0.2005	-19.3006	0.1145	0.51104	0.136	0.340704	0.1575	0.681365	0.179	-4.26242	0.2005	-9.38617
0.201	-16.4849	0.115	0.170357	0.1365	0.170357	0.158	0.85168	0.1795	-4.26242	0.201	-9.55713
0.2015	-19.6527	0.1155	0.340704	0.137	0.51104	0.1585	1.19228	0.18	-4.26242	0.2015	-9.89908
0.202	-10.1601	0.116	0.170357	0.1375	0.340704	0.159	1.87334	0.1805	-4.26242	0.202	-10.5831
0.2025	-18.5964	0.1165	0.170357	0.138	0.340704	0.1595	3.57525	0.181	-4.6037	0.2025	-11.0962
0.203	-14.3751	0.117	0.51104	0.1385	0.340704	0.16	9.56133	0.1815	-4.26242	0.203	-11.4384
0.2035	-17.8924	0.1175	0.170357	0.139	0.340704	0.1605	8.50473	0.182	-4.09179	0.2035	-11.9517
0.204	-16.8368	0.118	0.340704	0.1395	0.51104	0.161	9.863	0.1825	-3.75058	0.204	-12.4651
0.2045	-15.0782	0.1185	0	0.14	0.170357	0.1615	9.18395	0.183	-3.4094	0.2045	-12.8074
0.205	-12.2668	0.119	0.170357	0.1405	0.340704	0.162	7.14577	0.1835	-3.75058	0.205	-13.1497
0.2055	-14.7266	0.1195	0	0.141	0.340704	0.1625	3.74538	0.184	-4.09179	0.2055	-13.4921
0.206	-0.349731	0.12	0.170357	0.1415	0.340704	0.163	0.340704	0.1845	-3.92118	0.206	-13.6633
0.2065	-12.9694	0.1205	0	0.142	0.340704	0.1635	-2.04512	0.185	-5.11571	0.2065	-14.1771
0.207	-11.2132	0.121	0.170357	0.1425	0.170357	0.164	-3.4094	0.1855	-4.43306	0.207	-14.5196
0.2075	-8.75648	0.1215	0.170357	0.143	0.340704	0.1645	-3.92118	0.186	-5.2864	0.2075	-14.5196
0.208	-11.2132	0.122	0.170357	0.1435	0.340704	0.165	-5.62781	0.1865	-5.62781	0.208	-14.8621
0.2085	-11.5644	0.1225	0	0.144	0.170357	0.1655	-6.6523	0.187	-5.4571	0.2085	-15.0335
0.209	-11.2132	0.123	0.340704	0.1445	0.340704	0.166	-7.33551	0.1875	-5.62781		
0.2095	-10.1601	0.1235	0.170357	0.145	0.340704	0.1665	-6.82309	0.188	-5.62781		
0.21	-10.5111	0.124	0.170357	0.1455	0.170357	0.167	-6.48153	0.1885	-5.4571		
0.2105	-11.2132	0.1245	0.340704	0.146	0.51104	0.1675	-6.14001	0.189	-5.4571		
0.211	-10.8621	0.125	0.340704	0.1465	0.340704	0.168	-6.48153	0.1895	-5.62781		
0.2115	-10.8621	0.1255	0.340704	0.147	0.340704	0.1685	-6.14001	0.19	-5.4571		
0.212	-11.5644	0.126	0.51104	0.1475	0.681365	0.169	-5.62781	0.1905	-5.2864		
0.2125	-11.2132	0.1265	0.170357	0.148	0.340704	0.1695	-4.6037	0.191	-5.62781		
0.213	-10.5111	0.127	0.51104	0.1485	0.340704	0.17	-3.75058	0.1915	-5.79853		
0.2135	-9.10731	0.1275	0.170357	0.149	0.51104	0.1705	-2.72718	0.192	-5.79853		
		0.128	0.170357	0.1495	0.51104	0.171	-1.70416	0.1925	-5.62781		
		0.1285	0.170357	0.15	0.51104	0.1715	-1.02237	0.193	-5.62781		
		0.129	0.340704	0.1505	0.170357	0.172	-1.02237	0.1935	-5.62781		
		0.1295	0.340704	0.151	0.340704	0.1725	-1.02237	0.194	-5.62781		
		0.13	0.340704	0.1515	0.681365	0.173	-1.36324	0.1945	-6.14001		
		0.1305	0.340704	0.152	0.340704	0.1735	-1.70416	0.195	-5.96926		
		0.131	0.340704	0.1525	0.681365	0.174	-1.87464	0.1955	-6.14001		
		0.1315	0.340704	0.153	0.340704	0.1745	-2.04512	0.196	-6.48153		

Gauge30_1 Time msec	Gauge30_1 Stress MPa	Gauge30_1 Time msec	Gauge30_1 Stress MPa	Gauge30_1 Time msec	Gauge30_1 Stress MPa	Gauge30_1 Time msec	Gauge30_1 Stress MPa	Gauge30_2 Time msec	Gauge30_2 Stress MPa
-0.0335	0	-0.012	0	0.0095	147.54	0.031	37.5785	-0.0245	-2.82032
-0.033	18.847	-0.0115	0	0.01	93.0793	0.0315	37.5785	-0.024	-2.82032
-0.0325	0	-0.011	0	0.0105	74.6946	0.032	18.847	-0.0235	-2.82032
-0.032	18.847	-0.0105	0	0.011	56.1943	0.0325	0	-0.023	-2.82032
-0.0315	18.847	-0.01	0	0.0115	56.1943	0.033	-18.9626	-0.0225	-2.82032
-0.031	0	-0.0095	18.847	0.012	37.5785	0.0335	-18.9626	-0.022	-2.82032
-0.0305	0	-0.009	0	0.0125	37.5785	0.034	-18.9626	-0.0215	-2.82032
-0.03	18.847	-0.0085	0	0.013	37.5785	0.0345	0	-0.021	-2.82032
-0.0295	18.847	-0.008	0	0.0135	0	0.035	18.847	-0.0205	-2.82032
-0.029	0	-0.0075	0	0.014	0	0.0355	0	-0.02	-2.82032
-0.0285	-18.9626	-0.007	0	0.0145	-57.2346	0.036	-18.9626	-0.0195	-2.82032
-0.028	0	-0.0065	0	0.015	-115.51	0.0365	-18.9626	-0.019	-2.82032
-0.0275	0	-0.006	0	0.0155	-115.51	0.037	-38.0408	-0.0185	-2.82032
-0.027	18.847	-0.0055	0	0.016	-115.51	0.0375	-38.0408	-0.018	-3.17307
-0.0265	0	-0.005	0	0.0165	-135.166	0.038	-38.0408	-0.0175	-2.82032
-0.026	0	-0.0045	0	0.017	-135.166	0.0385	-57.2346	-0.017	-4.23155
-0.0255	0	-0.004	0	0.0175	-154.938	0.039	-38.0408	-0.0165	-3.87868
-0.025	0	-0.0035	0	0.018	-154.938	0.0395	-57.2346	-0.016	-0.352385
-0.0245	-18.9626	-0.003	0	0.0185	-115.51	0.04	-57.2346	-0.0155	-4.93743
-0.024	0	-0.0025	0	0.019	-115.51	0.0405	-76.544	-0.015	4.57697
-0.0235	0	-0.002	0	0.0195	-135.166	0.041	-57.2346	-0.0145	13.3578
-0.023	0	-0.0015	0	0.02	-135.166	0.0415	-57.2346	-0.014	28.7446
-0.0225	0	-0.001	0	0.0205	-115.51			-0.0135	7.74125
-0.022	18.847	-0.0005	0	0.021	-76.544			-0.013	3.52141
-0.0215	0	0	-57.2346	0.0215	-76.544			-0.0125	1.05689
-0.021	0	0.0005	289.473	0.022	-95.969			-0.012	0
-0.0205	0	0.001	464.149	0.0225	-57.2346			-0.0115	-0.352385
-0.02	0	0.0015	762.132	0.023	-38.0408			-0.011	0
-0.0195	18.847	0.002	817.501	0.0235	-38.0408			-0.0105	1.05689
-0.019	0	0.0025	762.132	0.024	-38.0408			-0.01	0.704638
-0.0185	0	0.003	655.843	0.0245	-38.0408			-0.0095	0
-0.018	-18.9626	0.0035	556.216	0.025	0			-0.009	-0.352385
-0.0175	0	0.004	289.473	0.0255	-18.9626			-0.0085	-0.704815
-0.017	0	0.0045	200.96	0.026	37.5785			-0.008	-0.352385
-0.0165	0	0.005	235.995	0.0265	0			-0.0075	0
-0.016	0	0.0055	165.462	0.027	-18.9626			-0.007	0.352341
-0.0155	0	0.006	111.348	0.0275	-18.9626			-0.0065	0
-0.015	0	0.0065	147.54	0.028	-38.0408			-0.006	0
-0.0145	0	0.007	93.0793	0.0285	-57.2346			-0.0055	0
-0.014	0	0.0075	129.502	0.029	-95.969			-0.005	-0.352385
-0.0135	0	0.008	37.5785	0.0295	-95.969			-0.0045	0
-0.013	0	0.0085	74.6946	0.03	-38.0408			-0.004	-0.352385
-0.0125	0	0.009	111.348	0.0305	0			-0.0035	-0.352385
-0.003	-0.352385	0.0185	-0.352385	0.04	-0.704815	0.0615	4.92874	0.083	-2.46763
-0.0025	-0.352385	0.019	-0.352385	0.0405	-0.352385	0.062	5.28046	0.0835	-4.23155
-0.002	0.352341	0.0195	-0.352385	0.041	-0.352385	0.0625	5.28046	0.084	-2.46763
-0.0015	0.704638	0.02	-0.704815	0.0415	-0.704815	0.063	5.98376	0.0845	-2.46763
-0.001	-0.352385	0.0205	-0.352385	0.042	0	0.0635	5.28046	0.085	-4.58447
-0.0005	-0.704815	0.021	-0.352385	0.0425	0.704638	0.064	4.22516	0.0855	-3.87868
0	-0.704815	0.0215	-0.352385	0.043	0	0.0645	3.52141	0.086	-2.82032
0.0005	0	0.022	-0.352385	0.0435	0	0.065	3.87331	0.0865	-3.17307
0.001	-10.9446	0.0225	-0.704815	0.044	0	0.0655	3.87331	0.087	-2.46763
0.0015	1.76126	0.023	0	0.0445	-0.352385	0.066	3.52141	0.0875	-2.46763
0.002	12.3055	0.0235	-0.704815	0.045	0	0.0665	2.81749	0.088	-2.11498
0.0025	0.352341	0.024	-0.704815	0.0455	0	0.067	2.46545	0.0885	-8.11609
0.003	-7.76273	0.0245	-0.704815	0.046	-0.352385	0.0675	2.81749	0.089	-2.46763
0.0035	-1.40981	0.025	-0.352385	0.0465	-0.352385	0.068	2.46545	0.0895	-1.40981
0.004	5.28046	0.0255	-0.352385	0.047	0	0.0685	1.76126	0.09	-1.05729
0.0045	3.52141	0.026	-0.352385	0.0475	-0.352385	0.069	1.05689	0.0905	-1.76237
0.005	-2.46763	0.0265	0	0.048	-0.352385	0.0695	0.704638	0.091	-1.05729
0.0055	-2.46763	0.027	0	0.0485	0	0.07	0	0.0915	-1.05729
0.006	6.33535	0.0275	-0.352385	0.049	-0.352385	0.0705	0	0.092	-0.704815
0.0065	4.57697	0.028	-0.352385	0.0495	-0.352385	0.071	0.352341	0.0925	-0.704815
0.007	-5.64349	0.0285	-0.352385	0.05	0	0.0715	0	0.093	-0.704815
0.0075	-2.11498	0.029	0	0.0505	0	0.072	-0.352385	0.0935	-0.704815
0.008	4.22516	0.0295	0	0.051	0	0.0725	-1.05729	0.094	-1.05729
0.0085	4.57697	0.03	0	0.0515	0.352341	0.073	-1.40981	0.0945	-0.704815
0.009	-2.46763	0.0305	-0.352385	0.052	1.05689	0.0735	-2.11498	0.095	-1.05729
0.0095	-6.34972	0.031	-0.352385	0.0525	2.11338	0.074	-2.11498	0.0955	-1.40981
0.01	-0.704815	0.0315	-0.704815	0.053	5.98376	0.0745	-1.76237	0.096	-1.76237
0.0105	8.44394	0.032	0.704638	0.0535	15.8114	0.075	-2.82032	0.0965	-2.11498
0.011	3.52141	0.0325	1.05689	0.054	21.7612	0.0755	-3.87868	0.097	-4.58447
0.0115	-3.87868	0.033	0	0.0545	20.3624	0.076	-3.87868	0.0975	-2.11498
0.012	-4.58447	0.0335	-1.05729	0.055	15.8114	0.0765	-4.58447	0.098	-2.46763
0.0125	0	0.034	-1.05729	0.0555	6.68689	0.077	-4.23155	0.0985	-2.82032
0.013	2.11338	0.0345	-0.352385	0.056	2.81749	0.0775	-3.52585	0.099	-2.82032
0.0135	1.05689	0.035	0.352341	0.0565	1.4091	0.078	-3.52585	0.0995	-2.82032
0.014	-0.704815	0.0355	0	0.057	1.76126	0.0785	-3.52585	0.1	-2.82032
0.0145	-1.76237	0.036	-0.352385	0.0575	3.87331	0.079	-2.82032	0.1005	-0.704815
0.015	-1.40981	0.0365	-0.704815	0.058	6.33535	0.0795	-2.82032	0.101	-3.17307
0.0155	-0.704815	0.037	-0.352385	0.0585	7.03839	0.08	-3.17307	0.1015	-3.17307
0.016	0.352341	0.0375	-0.352385	0.059	5.98376	0.0805	-2.82032	0.102	-2.46763
0.0165	0	0.038	-0.352385	0.0595	5.98376	0.081	-3.17307	0.1025	-3.52585
0.017	-0.704815	0.0385	-0.352385	0.06	6.68689	0.0815	-3.17307	0.103	-3.17307
0.0175	-1.05729	0.039	-0.704815	0.0605	7.03839	0.082	-2.82032	0.1035	-2.46763
0.018	-1.05729	0.0395	-0.704815	0.061	6.33535	0.0825	-2.82032	0.104	-2.46763

Gauge30_2 Time msec	Gauge30_2 Stress MPa	Gauge30_2 Time msec	Gauge30_2 Stress MPa	Gauge30_2 Time msec	Gauge30_2 Stress MPa	Gauge30_2 Time msec	Gauge30_2 Stress MPa	Gauge30_3 Time msec	Gauge30_3 Stress MPa
0.1045	-2.46763	0.126	4.92874	0.1475	0.704638	0.169	3.52141	-0.023	-2.46296
0.105	-1.76237	0.1265	5.98376	0.148	-2.46763	0.1695	3.52141	-0.0225	-2.46296
0.1055	-1.40981	0.127	7.38984	0.1485	0.704638	0.17	3.87331	-0.022	-2.46296
0.106	-2.11498	0.1275	3.87331	0.149	3.16947	0.1705	4.22516	-0.0215	-2.11097
0.1065	-2.11498	0.128	3.87331	0.1495	1.4091	0.171	3.87331	-0.021	-2.11097
0.107	-2.11498	0.1285	2.46545	0.15	-1.05729	0.1715	4.22516	-0.0205	-2.46296
0.1075	-2.11498	0.129	2.46545	0.1505	-1.05729	0.172	4.22516	-0.02	-2.11097
0.108	-1.76237	0.1295	0.352341	0.151	1.4091	0.1725	4.22516	-0.0195	-2.46296
0.1085	-0.704815	0.13	2.81749	0.1515	2.11338	0.173	4.22516	-0.019	-2.46296
0.109	-0.352385	0.1305	2.11338	0.152	1.05689	0.1735	4.22516	-0.0185	-2.11097
0.1095	0	0.131	1.4091	0.1525	0.352341	0.174	4.22516	-0.018	-2.81498
0.11	0	0.1315	0	0.153	0.704638	0.1745	4.22516	-0.0175	-2.11097
0.1105	1.05689	0.132	-0.352385	0.1535	1.76126	0.175	3.87331	-0.017	-2.11097
0.111	1.4091	0.1325	-0.704815	0.154	0.704638	0.1755	3.52141	-0.0165	-2.46296
0.1115	2.46545	0.133	-1.05729	0.1545	0.352341	0.176	3.16947	-0.016	-2.46296
0.112	2.81749	0.1335	-2.11498	0.155	1.4091	0.1765	2.81749	-0.0155	-2.81498
0.1125	3.52141	0.134	-1.05729	0.1555	0.352341	0.177	2.81749	-0.015	-12.6897
0.113	4.22516	0.1345	-0.704815	0.156	0.704638	0.1775	2.81749	-0.0145	-45.3798
0.1135	4.92874	0.135	-0.352385	0.1565	0.704638	0.178	2.11338	-0.014	-46.0947
0.114	4.57697	0.1355	-1.05729	0.157	1.05689	0.1785	2.11338	-0.0135	-8.45345
0.1145	4.22516	0.136	-0.352385	0.1575	1.05689	0.179	2.11338	-0.013	34.2535
0.115	4.22516	0.1365	0.352341	0.158	1.76126	0.1795	2.11338	-0.0125	22.7667
0.1155	3.87331	0.137	0.352341	0.1585	2.11338	0.18	1.4091	-0.012	3.51474
0.116	2.81749	0.1375	0.352341	0.159	2.11338	0.1805	1.4091	-0.0115	2.81215
0.1165	1.76126	0.138	6.33535	0.1595	3.16947	0.181	1.76126	-0.011	2.10938
0.117	1.4091	0.1385	0.352341	0.16	3.16947	0.1815	1.05689	-0.0105	1.75793
0.1175	0.352341	0.139	0.704638	0.1605	3.16947	0.182	1.76126	-0.01	1.05489
0.118	0.704638	0.1395	0.704638	0.161	3.52141	0.1825	1.05689	-0.0095	0.351674
0.1185	0.704638	0.14	1.4091	0.1615	4.22516	0.183	1.05689	-0.009	0
0.119	0.704638	0.1405	1.76126	0.162	3.87331	0.1835	0.704638	-0.0085	0
0.1195	1.76126	0.141	1.76126	0.1625	4.22516	0.184	1.05689	-0.008	0
0.12	1.05689	0.1415	-12.3599	0.163	4.92874	0.1845	0.704638	-0.0075	0
0.1205	1.76126	0.142	1.4091	0.1635	4.22516	0.185	0.352341	-0.007	0
0.121	2.81749	0.1425	1.76126	0.164	4.22516	0.1855	0.352341	-0.0065	0
0.1215	2.81749	0.143	0.352341	0.1645	3.52141	0.186	0.704638	-0.006	0
0.122	3.87331	0.1435	-5.64349	0.165	3.52141	0.1865	1.05689	-0.0055	-0.351718
0.1225	2.81749	0.144	-2.82032	0.1655	3.52141	0.187	1.05689	-0.005	-0.351718
0.123	1.76126	0.1445	14.4096	0.166	3.16947	0.1875	3.16947	-0.0045	-0.351718
0.1235	4.57697	0.145	8.44394	0.1665	3.16947	0.188	3.16947	-0.004	-0.351718
0.124	3.87331	0.1455	-3.87868	0.167	2.81749	0.1885	2.81749	-0.0035	-0.351718
0.1245	4.22516	0.146	-4.23155	0.1675	3.16947	0.189	3.16947	-0.003	-0.351718
0.125	4.92874	0.1465	4.57697	0.168	3.16947	0.1895	3.16947	-0.0025	0
0.1255	4.22516	0.147	6.68689	0.1685	3.52141	0.19	3.52141	-0.002	0.351674

Gauge30_3 Time msec	Gauge30_3 Stress MPa	Gauge30_3 Time msec	Gauge30_3 Stress MPa	Gauge30_3 Time msec	Gauge30_3 Stress MPa	Gauge30_3 Time msec	Gauge30_3 Stress MPa	Gauge30_3 Time msec	Gauge30_3 Stress MPa
-0.0015	0.703303	0.02	0	0.0415	1.05489	0.063	-4.92808	0.0845	-17.9941
-0.001	0	0.0205	0	0.042	0.703303	0.0635	-5.6328	0.085	-18.3481
-0.0005	-0.70348	0.021	-0.351718	0.0425	0.351674	0.064	-6.3377	0.0855	-18.7021
0	-0.70348	0.0215	-0.351718	0.043	1.05489	0.0645	-6.3377	0.086	-18.7021
0.0005	-0.70348	0.022	0	0.0435	1.05489	0.065	-6.3377	0.0865	-19.0561
0.001	-1.05529	0.0225	-0.351718	0.044	0.351674	0.0655	-6.3377	0.087	-18.7021
0.0015	-0.70348	0.023	-0.351718	0.0445	0.703303	0.066	-7.04277	0.0875	-18.3481
0.002	0.351674	0.0235	0.351674	0.045	0.703303	0.0665	-7.74802	0.088	-17.9941
0.0025	0	0.024	0	0.0455	0.351674	0.067	-8.10072	0.0885	-17.2863
0.003	-0.351718	0.0245	0.351674	0.046	0.351674	0.0675	-9.51193	0.089	-16.9324
0.0035	-0.70348	0.025	0.351674	0.0465	0.703303	0.068	-10.2178	0.0895	-16.9324
0.004	-0.351718	0.0255	0.351674	0.047	0.351674	0.0685	-11.6301	0.09	-16.5786
0.0045	-0.351718	0.026	0.351674	0.0475	0.351674	0.069	-11.6301	0.0905	-15.1639
0.005	-0.351718	0.0265	0.351674	0.048	0.351674	0.0695	-11.6301	0.091	-14.1033
0.0055	-0.351718	0.027	0.703303	0.0485	0.703303	0.07	-12.3365	0.0915	-13.7498
0.006	-0.351718	0.0275	0.351674	0.049	0.351674	0.0705	-12.3365	0.092	-13.3964
0.0065	-0.351718	0.028	0.351674	0.0495	0.351674	0.071	-12.6897	0.0925	-13.3964
0.007	-0.351718	0.0285	0.351674	0.05	0.351674	0.0715	-12.3365	0.093	-13.0431
0.0075	-0.351718	0.029	0.351674	0.0505	0.351674	0.072	-11.2769	0.0935	-13.0431
0.008	0	0.0295	0	0.051	0.351674	0.0725	-10.2178	0.094	-12.6897
0.0085	0	0.03	0.351674	0.0515	0.351674	0.073	-10.2178	0.0945	-12.3365
0.009	0	0.0305	-0.351718	0.052	0.351674	0.0735	-10.9238	0.095	-12.6897
0.0095	0	0.031	0	0.0525	0.703303	0.074	-10.9238	0.0955	-11.6301
0.01	0	0.0315	-0.351718	0.053	0.703303	0.0745	-11.2769	0.096	-11.2769
0.0105	0.351674	0.032	0.351674	0.0535	1.05489	0.075	-11.2769	0.0965	-11.6301
0.011	0	0.0325	0	0.054	1.75793	0.0755	-10.9238	0.097	-11.6301
0.0115	0	0.033	-0.351718	0.0545	4.5683	0.076	-11.2769	0.0975	-11.6301
0.012	0	0.0335	-0.351718	0.055	10.5309	0.0765	-12.3365	0.098	-11.9833
0.0125	0.351674	0.034	-0.351718	0.0555	17.5294	0.077	-12.6897	0.0985	-12.6897
0.013	0	0.0345	0.351674	0.056	21.022	0.0775	-13.7498	0.099	-13.0431
0.0135	0	0.035	0.351674	0.0565	17.5294	0.078	-14.1033	0.0995	-13.3964
0.014	0	0.0355	0.351674	0.057	12.6324	0.0785	-13.7498	0.1	-14.4567
0.0145	0	0.036	0.351674	0.0575	7.02506	0.079	-13.7498	0.1005	-15.1639
0.015	0	0.0365	0.351674	0.058	1.75793	0.0795	-13.7498	0.101	-15.1639
0.0155	0	0.037	0.703303	0.0585	1.40643	0.08	-14.1033	0.1015	-15.1639
0.016	0	0.0375	0.703303	0.059	3.16347	0.0805	-14.4567	0.102	-15.1639
0.0165	0	0.038	0.703303	0.0595	3.86597	0.081	-15.1639	0.1025	-15.8711
0.017	0	0.0385	0.703303	0.06	2.81215	0.0815	-15.5175	0.103	-16.2249
0.0175	0	0.039	0.351674	0.0605	2.46079	0.082	-16.2249	0.1035	-16.5786
0.018	0	0.0395	0.703303	0.061	1.75793	0.0825	-16.9324	0.104	-16.9324
0.0185	0	0.04	1.05489	0.0615	0.351674	0.083	-17.9941	0.1045	-17.6401
0.019	0	0.0405	1.05489	0.062	-1.40714	0.0835	-17.9941	0.105	-18.3481
0.0195	0	0.041	1.05489	0.0625	-3.51917	0.084	-17.9941	0.1055	-18.3481



Gauge30_3 Time msec	Gauge30_3 Stress MPa	Gauge30_3 Time msec	Gauge30_3 Stress MPa	Gauge30_3 Time msec	Gauge30_3 Stress MPa	Gauge30_3 Time msec	Gauge30_3 Stress MPa	Gauge30_3 Time msec	Gauge30_3 Stress MPa
0.106	-1.76401	0.1275	-13.3964	0.149	-10.2178	0.1705	-7.74802	0.192	0.703303
0.1065	-1.76401	0.128	-13.0431	0.1495	-9.86484	0.171	-8.45345	0.1925	0
0.107	-1.72863	0.1285	-13.0431	0.15	-10.2178	0.1715	-9.15906	0.193	-0.351718
0.1075	-1.76401	0.129	-13.0431	0.1505	-10.2178	0.172	-9.86484	0.1935	-0.70348
0.108	-16.9324	0.1295	-13.0431	0.151	-10.2178	0.1725	-10.2178	0.194	-1.05529
0.1085	-1.69324	0.13	-13.3964	0.1515	-9.86484	0.173	-10.9238	0.1945	-1.05529
0.109	-16.2249	0.1305	-13.3964	0.152	-9.86484	0.1735	-10.2178	0.195	-1.05529
0.1095	-15.8711	0.131	-13.3964	0.1525	-9.51193	0.174	-9.86484	0.1955	-1.05529
0.11	-15.1639	0.1315	-13.3964	0.153	-9.15906	0.1745	-9.86484	0.196	-1.05529
0.1105	-14.8103	0.132	-13.7498	0.1535	-8.80623	0.175	-9.86484	0.1965	-1.75903
0.111	-13.7498	0.1325	-14.1033	0.154	-8.45345	0.1755	-10.5708	0.197	-2.81498
0.1115	-13.3964	0.133	-14.1033	0.1545	-8.10072	0.176	-10.5708	0.1975	-2.81498
0.112	-12.6897	0.1335	-13.7498	0.155	-8.10072	0.1765	-10.5708	0.198	-3.87133
0.1125	-1.19833	0.134	-13.7498	0.1555	-7.74802	0.177	-10.5708	0.1985	-4.22354
0.113	-1.16301	0.1345	-13.7498	0.156	-7.74802	0.1775	-10.9238	0.199	-4.92808
0.1135	-1.16301	0.135	-13.7498	0.1565	-7.74802	0.178	-11.2769	0.1995	-5.6328
0.114	-1.16301	0.1355	-14.1033	0.157	-7.74802	0.1785	-11.2769	0.2	-6.69021
0.1145	-12.6897	0.136	-14.1033	0.1575	-7.04277	0.179	-10.9238	0.2005	-7.39538
0.115	-13.0431	0.1365	-13.7498	0.158	-7.04277	0.1795	-10.9238	0.201	-8.45345
0.1155	-13.0431	0.137	-14.4567	0.1585	-6.69021	0.18	-10.5708	0.2015	-9.15906
0.116	-13.3964	0.1375	-13.7498	0.159	-6.3377	0.1805	-10.9238	0.202	-9.86484
0.1165	-13.7498	0.138	-13.7498	0.1595	-6.3377	0.181	-10.2178	0.2025	-10.2178
0.117	-14.1033	0.1385	-13.7498	0.16	-6.3377	0.1815	-9.51193	0.203	-10.2178
0.1175	-15.5175	0.139	-13.7498	0.1605	-5.6328	0.182	-9.15906	0.2035	-10.5708
0.118	-16.5786	0.1395	-13.3964	0.161	-5.98523	0.1825	-8.10072	0.204	-1.12769
0.1185	-16.9324	0.14	-13.3964	0.1615	-6.3377	0.183	-7.39538	0.2045	-1.12769
0.119	-17.6401	0.1405	-13.3964	0.162	-5.6328	0.1835	-6.3377	0.205	-10.9238
0.1195	-18.7021	0.141	-13.3964	0.1625	-5.28042	0.184	-5.6328	0.2055	-1.12769
0.12	-18.3481	0.1415	-12.3365	0.163	-4.92808	0.1845	-4.92808	0.206	-10.2178
0.1205	-19.0561	0.142	-12.3365	0.1635	-4.57579	0.185	-3.87133	0.2065	-9.51193
0.121	-19.0561	0.1425	-11.9833	0.164	-3.87133	0.1855	-3.16706	0.207	-8.80623
0.1215	-18.7021	0.143	-11.2769	0.1645	-3.87133	0.186	-2.81498	0.2075	-8.45345
0.122	-18.7021	0.1435	-10.5708	0.165	-3.87133	0.1865	-2.46296	0.208	-8.10072
0.1225	-17.6401	0.144	-10.2178	0.1655	-3.51917	0.187	-1.75903	0.2085	-6.69021
0.123	-17.2863	0.1445	-10.2178	0.166	-3.51917	0.1875	-1.40714	0.209	-5.98523
0.1235	-16.9324	0.145	-9.51193	0.1665	-3.51917	0.188	-1.75903	0.2095	-5.28042
0.124	-16.2249	0.1455	-9.15906	0.167	-3.87133	0.1885	-0.70348	0.21	-4.22354
0.1245	-15.8711	0.146	-9.15906	0.1675	-4.22354	0.189	-0.351718	0.2105	-3.87133
0.125	-15.5175	0.1465	-8.80623	0.168	-4.92808	0.1895	-0.351718	0.211	-3.51917
0.1255	-14.8103	0.147	-9.51193	0.1685	-5.6328	0.19	-0.351718	0.2115	-3.16706
0.126	-14.4567	0.1475	-9.86484	0.169	-5.98523	0.1905	0.351674	0.212	-2.46296
0.1265	-14.1033	0.148	-10.2178	0.1695	-6.69021	0.191	0.351674	0.2125	-2.46296
0.127	-13.3964	0.1485	-10.2178	0.17	-7.74802	0.1915	0.703303	0.213	-2.46296

Gauge30_3 Time msec	Gauge30_3 Stress MPa	Gauge30_4 Time msec	Gauge30_4 Stress MPa	Gauge30_4 Time msec	Gauge30_4 Stress MPa	Gauge30_4 Time msec	Gauge30_4 Stress MPa	Gauge30_4 Time msec	Gauge30_4 Stress MPa
0.2135	-2.81498	-0.0165	-1.68255	0.005	0.336383	0.0265	0.336383	0.048	0
0.214	-2.46296	-0.016	-1.34596	0.0055	0.672725	0.027	0.336383	0.0485	0.336383
0.2145	-3.16706	-0.0155	-1.34596	0.006	0.672725	0.0275	0.336383	0.049	0
0.215	-3.51917	-0.015	-1.34596	0.0065	0.336383	0.028	0.336383	0.0495	0
0.2155	-3.16706	-0.0145	-1.68255	0.007	0	0.0285	0.672725	0.05	0.336383
0.216	-4.22354	-0.014	-7.07384	0.0075	0.336383	0.029	0.336383	0.0505	0
0.2165	-4.57579	-0.0135	-2.01919	0.008	0.672725	0.0295	0.336383	0.051	0.336383
0.217	-5.28042	-0.013	29.7722	0.0085	0.672725	0.03	0.672725	0.0515	0.336383
0.2175	-5.6328	-0.0125	20.4419	0.009	0.336383	0.0305	0.672725	0.052	0.336383
0.218	-6.3377	-0.012	2.68988	0.0095	0	0.031	0.672725	0.0525	0.336383
0.2185	-7.04277	-0.0115	2.35379	0.01	0	0.0315	0.672725	0.053	0.336383
0.219	-7.74802	-0.011	2.35379	0.0105	0.336383	0.032	0.336383	0.0535	0.336383
0.2195	-8.45345	-0.0105	2.01767	0.011	0	0.0325	0.672725	0.054	0.336383
0.22	-9.15906	-0.01	1.00902	0.0115	0	0.033	0.336383	0.0545	0.336383
0.2205	-8.80623	-0.0095	0.672725	0.012	0	0.0335	0.336383	0.055	0.336383
0.221	-8.45345	-0.009	0.336383	0.0125	0.336383	0.034	0.336383	0.0555	0
0.2215	-9.15906	-0.0085	0.336383	0.013	0	0.0345	0	0.056	0
0.222	-10.5708	-0.008	0.336383	0.0135	0	0.035	0	0.0565	0
0.2225	-9.15906	-0.0075	0	0.014	-0.336426	0.0355	0.336383	0.057	0
0.223	-9.15906	-0.007	0	0.0145	-0.336426	0.036	0	0.0575	0
0.2235	-9.51193	-0.0065	0	0.015	-0.336426	0.0365	0	0.058	0.336383
0.224	-9.51193	-0.006	0.336383	0.0155	-0.336426	0.037	-0.336426	0.0585	0
0.2245	-9.15906	-0.0055	0	0.016	-0.336426	0.0375	-0.336426	0.059	-0.336426
0.225	-9.15906	-0.005	0	0.0165	-0.336426	0.038	-0.336426	0.0595	-0.336426
0.2255	-9.15906	-0.0045	0	0.017	-0.336426	0.0385	-0.336426	0.06	0
0.226	-9.15906	-0.004	0	0.0175	-0.336426	0.039	-0.672894	0.0605	0
		-0.0035	0	0.018	-0.336426	0.0395	-0.336426	0.061	-0.336426
		-0.003	0	0.0185	-0.336426	0.04	-0.336426	0.0615	-0.672894
		-0.0025	0	0.019	-0.336426	0.0405	-0.336426	0.062	-0.672894
		-0.002	0	0.0195	-0.336426	0.041	-0.336426	0.0625	-0.672894
		-0.0015	0.336383	0.02	-0.336426	0.0415	-0.336426	0.063	-0.336426
		-0.001	0	0.0205	0	0.042	-0.336426	0.0635	-0.336426
		-0.0005	-0.672894	0.021	-0.336426	0.0425	-0.672894	0.064	-0.336426
		0	-0.672894	0.0215	-0.336426	0.043	-0.336426	0.0645	-0.672894
		0.0005	-0.336426	0.022	0	0.0435	-0.336426	0.065	-0.336426
		0.001	-2.35587	0.0225	-0.336426	0.044	-0.672894	0.0655	0
		0.0015	-4.03991	0.023	-0.336426	0.0445	-0.672894	0.066	-0.336426
		0.002	-1.0094	0.0235	-0.336426	0.045	0	0.0665	0
		0.0025	1.34528	0.024	-0.336426	0.0455	-0.336426	0.067	0
		0.003	1.34528	0.0245	-0.336426	0.046	-0.336426	0.0675	0
		0.0035	0	0.025	0.336383	0.0465	0	0.068	0
		0.004	-0.336426	0.0255	0.336383	0.047	-0.336426	0.0685	-0.336426
		0.0045	0	0.026	0.336383	0.0475	0	0.069	0

Gauge30_4 Time msec	Gauge30_4 Stress MPa	Gauge30_4 Time msec	Gauge30_4 Stress MPa	Gauge30_4 Time msec	Gauge30_4 Stress MPa	Gauge30_4 Time msec	Gauge30_4 Stress MPa	Gauge30_4 Time msec	Gauge30_4 Stress MPa
0.0695	-0.336426	0.091	0	0.1125	6.38404	0.134	-3.70301	0.1555	-8.42335
0.07	0	0.0915	-0.336426	0.113	2.01767	0.1345	-4.03991	0.156	-8.76084
0.0705	0	0.092	-0.672894	0.1135	0	0.135	-4.03991	0.1565	-8.42335
0.071	0	0.0925	-0.336426	0.114	-1.34596	0.1355	-3.70301	0.157	-8.76084
0.0715	0	0.093	-0.336426	0.1145	-3.02936	0.136	-3.70301	0.1575	-8.42335
0.072	0	0.0935	-0.336426	0.115	-4.71382	0.1365	-3.36616	0.158	-8.76084
0.0725	0	0.094	-0.336426	0.1155	-6.39933	0.137	-3.70301	0.1585	-9.09837
0.073	-0.336426	0.0945	0	0.116	-7.41115	0.1375	-3.70301	0.159	-8.76084
0.0735	0	0.095	-0.336426	0.1165	-7.41115	0.138	-3.36616	0.1595	-9.09837
0.074	-0.336426	0.0955	0	0.117	-6.73656	0.1385	-3.02936	0.16	-9.09837
0.0745	-0.336426	0.096	0	0.1175	-6.73656	0.139	-3.02936	0.1605	-9.43594
0.075	-0.336426	0.0965	-0.336426	0.118	-6.73656	0.1395	-3.02936	0.161	-9.09837
0.0755	0	0.097	0	0.1185	-6.06215	0.14	-2.69259	0.1615	-10.1112
0.076	0	0.0975	0	0.119	-6.06215	0.1405	-2.69259	0.162	-9.09837
0.0765	0	0.098	-0.336426	0.1195	-6.39933	0.141	-2.69259	0.1625	-8.42335
0.077	0	0.0985	0	0.12	-6.06215	0.1415	-2.35587	0.163	-8.76084
0.0775	-0.336426	0.099	0	0.1205	-6.39933	0.142	-2.35587	0.1635	-8.42335
0.078	-0.336426	0.0995	0.336383	0.121	-6.06215	0.1425	-2.35587	0.164	-7.74851
0.0785	-0.336426	0.1	0	0.1215	-6.06215	0.143	-2.69259	0.1645	-7.74851
0.079	0	0.1005	0	0.122	-5.725	0.1435	-2.69259	0.165	-6.73656
0.0795	0	0.101	0	0.1225	-5.3879	0.144	-3.02936	0.1655	-6.39933
0.08	0	0.1015	0	0.123	-5.05084	0.1445	-3.02936	0.166	-3.36616
0.0805	0	0.102	0.336383	0.1235	-4.71382	0.145	-3.02936	0.1665	-5.725
0.081	0	0.1025	0	0.124	-4.37684	0.1455	-3.36616	0.167	-5.725
0.0815	0	0.103	0	0.1245	-3.70301	0.146	-3.70301	0.1675	-4.37684
0.082	0	0.1035	0	0.125	-4.03991	0.1465	-3.36616	0.168	-2.69259
0.0825	0	0.104	0	0.1255	-3.36616	0.147	-4.37684	0.1685	-4.37684
0.083	0	0.1045	0	0.126	-3.36616	0.1475	-4.37684	0.169	-6.06215
0.0835	0	0.105	0	0.1265	-3.36616	0.148	-4.37684	0.1695	-4.37684
0.084	0	0.1055	0	0.127	-3.02936	0.1485	-5.05084	0.17	-4.71382
0.0845	0	0.106	-0.336426	0.1275	-3.02936	0.149	-5.3879	0.1705	-5.3879
0.085	0	0.1065	0	0.128	-3.36616	0.1495	-5.3879	0.171	-7.41115
0.0855	0	0.107	0	0.1285	-3.36616	0.15	-6.06215	0.1715	-5.725
0.086	0	0.1075	0.336383	0.129	-3.36616	0.1505	-6.39933	0.172	-6.06215
0.0865	0	0.108	0.672725	0.1295	-3.36616	0.151	-6.39933	0.1725	-6.39933
0.087	0	0.1085	1.68149	0.13	-3.02936	0.1515	-6.39933	0.173	-6.06215
0.0875	0	0.109	3.36193	0.1305	-3.36616	0.152	-6.73656	0.1735	-6.39933
0.088	0	0.1095	4.70551	0.131	-3.36616	0.1525	-7.41115	0.174	-5.725
0.0885	0	0.11	6.71962	0.1315	-3.36616	0.153	-7.41115	0.1745	-6.06215
0.089	0	0.1105	10.4082	0.132	-3.36616	0.1535	-7.74851	0.175	-6.73656
0.0895	-0.336426	0.111	12.7528	0.1325	-3.36616	0.154	-8.08591	0.1755	-7.74851
0.09	-0.672894	0.1115	12.0831	0.133	-3.70301	0.1545	-8.08591	0.176	-8.08591
0.0905	0	0.112	10.4082	0.1335	-4.03991	0.155	-8.08591	0.1765	-8.42335

Gauge30_4 Time msec	Gauge30_4 Stress MPa	Gauge30_4 Time msec	Gauge30_4 Stress MPa	Gauge30_4 Time msec	Gauge30_4 Stress MPa	Gauge30_5 Time msec	Gauge30_5 Stress MPa	Gauge30_5 Time msec	Gauge30_5 Stress MPa
0.177	-8.76084	0.1985	-4.03991	0.22	-1.34596	0.055	-0.70348	0.0765	-0.70348
0.1775	-8.42335	0.199	-4.37684	0.2205	-1.34596	0.0555	-0.70348	0.077	-0.351718
0.178	-9.43594	0.1995	-3.36616	0.221	-1.68255	0.056	-0.70348	0.0775	-0.70348
0.1785	-9.43594	0.2	-3.36616	0.2215	-1.68255	0.0565	-0.351718	0.078	-0.70348
0.179	-10.1112	0.2005	-3.70301	0.222	-2.01919	0.057	-0.351718	0.0785	-0.351718
0.1795	-10.1112	0.201	-3.02936	0.2225	-2.69259	0.0575	-0.351718	0.079	-0.351718
0.18	-10.1112	0.2015	-2.69259	0.223	-1.68255	0.058	-0.351718	0.0795	-0.351718
0.1805	-9.77355	0.202	-2.69259	0.2235	-2.35587	0.0585	-0.70348	0.08	-0.351718
0.181	-9.77355	0.2025	-2.69259	0.224	-2.69259	0.059	-0.351718	0.0805	0
0.1815	-8.76084	0.203	-2.69259	0.2245	-3.36616	0.0595	0	0.081	-0.351718
0.182	-8.76084	0.2035	-2.69259	0.225	-3.02936	0.06	-0.351718	0.0815	0
0.1825	-8.42335	0.204	-3.36616	0.2255	-3.70301	0.0605	-0.351718	0.082	-0.351718
0.183	-9.09837	0.2045	-3.36616	0.226	-3.70301	0.061	-0.351718	0.0825	0
0.1835	-8.42335	0.205	-3.36616			0.0615	-0.351718	0.083	0
0.184	-6.39933	0.2055	-3.36616			0.062	-0.351718	0.0835	0
0.1845	-8.76084	0.206	-3.36616			0.0625	-0.70348	0.084	0
0.185	-9.09837	0.2065	-3.36616			0.063	-0.351718	0.0845	0
0.1855	-9.09837	0.207	-3.36616			0.0635	-0.351718	0.085	0
0.186	-9.77355	0.2075	-3.36616			0.064	-0.70348	0.0855	-0.351718
0.1865	-9.77355	0.208	-3.36616			0.0645	-0.351718	0.086	-0.351718
0.187	-9.09837	0.2085	-3.02936			0.065	-0.70348	0.0865	-0.351718
0.1875	-10.7866	0.209	-3.02936			0.0655	-0.351718	0.087	-0.351718
0.188	-11.1244	0.2095	-3.02936			0.066	-0.351718	0.0875	-0.351718
0.1885	-13.4901	0.21	-3.02936			0.0665	-0.351718	0.088	-0.351718
0.189	-13.152	0.2105	-3.02936			0.067	-0.70348	0.0885	-0.351718
0.1895	-12.138	0.211	-3.36616			0.0675	-0.70348	0.089	-0.351718
0.19	-11.4622	0.2115	-3.36616			0.068	-0.70348	0.0895	-0.351718
0.1905	-11.1244	0.212	-3.02936			0.0685	-0.70348	0.09	-0.351718
0.191	-12.476	0.2125	-2.69259			0.069	-0.70348	0.0905	-0.70348
0.1915	-10.7866	0.213	-2.69259			0.0695	-0.351718	0.091	-0.70348
0.192	-9.77355	0.2135	-3.70301			0.07	-1.05529	0.0915	-0.70348
0.1925	-11.1244	0.214	-3.02936			0.0705	-1.05529	0.092	-0.70348
0.193	-8.76084	0.2145	-1.34596			0.071	-0.70348	0.0925	-0.70348
0.1935	-6.39933	0.215	-2.01919			0.0715	-0.70348	0.093	-0.351718
0.194	-5.3879	0.2155	-2.01919			0.072	-1.05529	0.0935	-0.351718
0.1945	-10.1112	0.216	-2.01919			0.0725	-0.70348	0.094	-0.351718
0.195	-7.74851	0.2165	-0.672894			0.073	-1.40714	0.0945	-0.351718
0.1955	-6.39933	0.217	-1.34596			0.0735	-1.05529	0.095	-0.351718
0.196	-5.725	0.2175	-0.336426			0.074	-0.70348	0.0955	-0.70348
0.1965	-5.725	0.218	-1.34596			0.0745	-0.70348	0.096	-0.70348
0.197	-6.06215	0.2185	-1.34596			0.075	-0.70348	0.0965	-0.351718
0.1975	-5.3879	0.219	-0.672894			0.0755	-0.70348	0.097	-0.351718
0.198	-3.70301	0.2195	-1.34596			0.076	-0.70348	0.0975	-0.351718

Gauge30_5	Gauge30_5	Gauge30_5	Gauge30_5	Gauge30_5	Gauge30_5	Gauge30_5	Gauge30_5	Gauge30_5	Gauge30_5
Time	Stress	Time	Stress	Time	Stress	Time	Stress	Time	Stress
msec	MPa	msec	MPa	msec	MPa	msec	MPa	msec	MPa
0.098	-0.351718	0.1195	1.40643	0.141	-1.75903	0.1625	1.40643	0.184	-3.51917
0.0985	0	0.12	1.05489	0.1415	-1.40714	0.163	1.40643	0.1845	-2.81498
0.099	0	0.1205	1.05489	0.142	-1.40714	0.1635	1.75793	0.185	-2.81498
0.0995	0	0.121	1.40643	0.1425	-1.75903	0.164	2.10938	0.1855	-3.16706
0.1	0	0.1215	1.40643	0.143	-1.40714	0.1645	2.46079	0.186	-3.16706
0.1005	0	0.122	1.40643	0.1435	-1.05529	0.165	2.81215	0.1865	-3.16706
0.101	0	0.1225	1.75793	0.144	-1.05529	0.1655	3.51474	0.187	-3.51917
0.1015	0	0.123	2.10938	0.1445	-0.70348	0.166	3.16347	0.1875	-3.87133
0.102	0	0.1235	2.46079	0.145	-1.05529	0.1665	3.16347	0.188	-4.57579
0.1025	0	0.124	2.10938	0.1455	-1.05529	0.167	2.81215	0.1885	-4.92808
0.103	0	0.1245	1.75793	0.146	-1.05529	0.1675	2.81215	0.189	-5.98523
0.1035	0.351674	0.125	1.40643	0.1465	-1.05529	0.168	2.46079	0.1895	-6.90221
0.104	0	0.1255	1.40643	0.147	-1.05529	0.1685	2.10938	0.19	-6.69021
0.1045	0	0.126	1.40643	0.1475	-1.05529	0.169	1.75793	0.1905	-8.45345
0.105	0	0.1265	1.40643	0.148	-1.40714	0.1695	1.05489	0.191	-8.10072
0.1055	0	0.127	1.75793	0.1485	-1.40714	0.17	0.703303	0.1915	-8.45345
0.106	0	0.1275	1.75793	0.149	-1.75903	0.1705	1.05489	0.192	-8.45345
0.1065	0	0.128	2.10938	0.1495	-1.40714	0.171	0.703303	0.1925	-8.80623
0.107	0	0.1285	2.46079	0.15	-1.40714	0.1715	0.703303	0.193	-8.80623
0.1075	0	0.129	3.16347	0.1505	-1.05529	0.172	-0.351718	0.1935	-9.15906
0.108	0	0.1295	3.16347	0.151	-1.05529	0.1725	-0.351718	0.194	-9.15906
0.1085	0.351674	0.13	2.81215	0.1515	-1.05529	0.173	-0.70348	0.1945	-9.15906
0.109	0.703303	0.1305	2.81215	0.152	-1.05529	0.1735	-0.70348	0.195	-9.15906
0.1095	1.05489	0.131	2.81215	0.1525	-1.40714	0.174	-0.351718	0.1955	-9.15906
0.11	2.46079	0.1315	2.81215	0.153	-1.40714	0.1745	-0.351718	0.196	-10.5708
0.1105	4.5683	0.132	3.16347	0.1535	-1.05529	0.175	-0.70348	0.1965	-10.2178
0.111	7.02506	0.1325	3.16347	0.154	-0.70348	0.1755	-0.351718	0.197	-8.80623
0.1115	7.02506	0.133	2.10938	0.1545	-0.70348	0.176	-1.05529	0.1975	-8.10072
0.112	7.02506	0.1335	1.75793	0.155	-0.70348	0.1765	-1.75903	0.198	-7.74802
0.1125	6.32335	0.134	1.40643	0.1555	-1.05529	0.177	-2.11097	0.1985	-7.39538
0.113	5.97243	0.1345	1.40643	0.156	-0.70348	0.1775	-3.16706	0.199	-7.39538
0.1135	6.32335	0.135	0.703303	0.1565	-1.05529	0.178	-3.51917	0.1995	-7.74802
0.114	5.97243	0.1355	0	0.157	-1.05529	0.1785	-4.22354	0.2	-7.39538
0.1145	4.5683	0.136	-0.70348	0.1575	-0.351718	0.179	-3.51917	0.2005	-7.04277
0.115	3.86597	0.1365	-1.05529	0.158	-0.351718	0.1795	-3.16706	0.201	-6.69021
0.1155	4.21716	0.137	-1.05529	0.1585	-0.70348	0.18	-3.16706	0.2015	-6.69021
0.116	3.51474	0.1375	-1.05529	0.159	-1.05529	0.1805	-2.81498	0.202	-6.69021
0.1165	2.46079	0.138	-1.05529	0.1595	0	0.181	-2.81498	0.2025	-6.3377
0.117	2.46079	0.1385	-1.40714	0.16	-0.351718	0.1815	-2.81498	0.203	-5.6328
0.1175	2.10938	0.139	-1.40714	0.1605	-2.11097	0.182	-3.16706	0.2035	-5.28042
0.118	2.10938	0.1395	-1.40714	0.161	0.351674	0.1825	-3.16706	0.204	-4.92808
0.1185	1.40643	0.14	-1.40714	0.1615	0.351674	0.183	-3.51917	0.2045	-4.92808
0.119	1.40643	0.1405	-1.75903	0.162	0.351674	0.1835	-3.51917	0.205	-4.57579

Gauge30_5	Gauge30_5	Gauge30_6	Gauge30_6	Gauge30_6	Gauge30_6	Gauge30_6	Gauge30_6	Gauge30_6	Gauge30_6
Time	Stress	Time	Stress	Time	Stress	Time	Stress	Time	Stress
msec	MPa	msec	MPa	msec	MPa	msec	MPa	msec	MPa
0.2055	-3.87133	0.0745	0.175179	0.096	0.175179	0.1175	-0.17519	0.139	-1.22656
0.206	-4.22354	0.075	0.175179	0.0965	0	0.118	0	0.1395	-1.22656
0.2065	-4.57579	0.0755	0.175179	0.097	0.175179	0.1185	0	0.14	-1.22656
0.207	-4.22354	0.076	-0.17519	0.0975	0.175179	0.119	0	0.1405	-1.22656
0.2075	-4.57579	0.0765	0	0.098	0.175179	0.1195	0.175179	0.141	-1.0513
0.208	-4.57579	0.077	0	0.0985	0.350347	0.12	0.175179	0.1415	-0.700825
0.2085	-4.92808	0.0775	0	0.099	0.175179	0.1205	0.175179	0.142	-0.350391
0.209	-4.22354	0.078	0	0.0995	0	0.121	0.175179	0.1425	0
0.2095	-4.22354	0.0785	0	0.1	0	0.1215	0.175179	0.143	0.525503
0.21	-4.22354	0.079	-0.17519	0.1005	0.350347	0.122	0.350347	0.1435	0.700649
0.2105	-4.22354	0.0795	-0.17519	0.101	0.175179	0.1225	0.350347	0.144	1.22602
0.211	-3.87133	0.08	-0.17519	0.1015	0	0.123	0.350347	0.1445	1.57621
0.2115	-3.51917	0.0805	-0.17519	0.102	0	0.1235	0	0.145	1.75129
0.212	-4.22354	0.081	-0.17519	0.1025	0	0.124	-0.17519	0.1455	2.10142
0.2125	-3.16706	0.0815	-0.17519	0.103	0	0.1245	-0.350391	0.146	2.10142
0.213	-3.16706	0.082	-0.350391	0.1035	0.175179	0.125	-0.876059	0.1465	2.27646
0.2135	-2.81498	0.0825	-0.350391	0.104	0	0.1255	-1.0513	0.147	1.92636
0.214	-3.87133	0.083	-0.17519	0.1045	0.350347	0.126	-1.0513	0.1475	1.92636
0.2145	-2.11097	0.0835	-0.17519	0.105	0	0.1265	-1.57711	0.148	1.75129
0.215	-2.11097	0.084	-0.350391	0.1055	0.175179	0.127	-1.57711	0.1485	1.40112
0.2155	-1.75903	0.0845	-0.17519	0.106	-0.17519	0.1275	-1.75239	0.149	1.22602
0.216	-1.75903	0.085	-0.350391	0.1065	0.175179	0.128	-1.75239	0.1495	1.22602
0.2165	-2.81498	0.0855	-0.17519	0.107	0	0.1285	-1.40183	0.15	0.875784
0.217	-3.16706	0.086	-0.17519	0.1075	0	0.129	-1.0513	0.1505	0.875784
0.2175	-3.16706	0.0865	-0.17519	0.108	0.175179	0.1295	-0.700825	0.151	0.525503
0.218	-2.46296	0.087	-0.350391	0.1085	-0.17519	0.13	0	0.1515	0.700649
0.2185	-2.81498	0.0875	-0.17519	0.109	0	0.1305	0.525503	0.152	0.350347
0.219	-2.46296	0.088	-0.17519	0.1095	0.175179	0.131	1.05091	0.1525	0.175179
0.2195	-3.87133	0.0885	-0.350391	0.11	-0.17519	0.1315	1.40112	0.153	0
0.22	-3.16706	0.089	-0.17519	0.1105	-0.17519	0.132	1.75129	0.1535	0
0.2205	-3.51917	0.0895	-0.17519	0.111	-0.17519	0.1325	2.4515	0.154	-0.17519
0.221	-3.87133	0.09	-0.17519	0.1115	0	0.133	2.62652	0.1545	0
0.2215	-3.87133	0.0905	-0.17519	0.112	-1.992E-14	0.1335	2.62652	0.155	0.175179
0.222	-4.22354	0.091	-0.17519	0.1125	-0.17519	0.134	2.4515	0.1555	0
0.2225	-3.51917	0.0915	-0.17519	0.113	-0.17519	0.1345	2.10142	0.156	0.175179
0.223	-3.51917	0.092	0	0.1135	0	0.135	1.22602	0.1565	0.350347
0.2235	-3.87133	0.0925	-0.350391	0.114	-0.17519	0.1355	1.05091	0.157	0.350347
0.224	-3.16706	0.093	0	0.1145	-0.17519	0.136	0.700649	0.1575	0.525503
0.2245	-2.81498	0.0935	0	0.115	-0.350391	0.1365	0.350347	0.158	0.525503
		0.094	0.175179	0.1155	-0.17519	0.137	0.175179	0.1585	0.525503
		0.0945	0.175179	0.116	-0.350391	0.1375	-0.350391	0.159	0.525503
		0.095	0.175179	0.1165	-0.17519	0.138	-0.700825	0.1595	0.700649
		0.0955	0	0.117	-0.17519	0.1385	-1.0513	0.16	0.525503

Gauge30_6 Time msec	Gauge30_6 Stress MPa	Gauge30_6 Time msec	Gauge30_6 Stress MPa	Gauge30_6 Time msec	Gauge30_6 Stress MPa	Gauge30_6 Time msec	Gauge30_6 Stress MPa
0.1605	0.525503	0.182	18.6816	0.2035	2.80154	0.225	3.50148
0.161	0.700649	0.1825	18.3336	0.204	2.80154	0.2255	3.67644
0.1615	1.05091	0.183	17.9855	0.2045	2.62652	0.226	3.50148
0.162	1.05091	0.1835	17.2892	0.205	2.62652	0.2265	4.02632
0.1625	1.22602	0.184	16.5927	0.2055	2.4515	0.227	3.85139
0.163	1.57621	0.1845	15.8961	0.206	2.4515	0.2275	3.85139
0.1635	1.75129	0.185	15.1993	0.2065	2.27646	0.228	3.50148
0.164	2.27646	0.1855	14.6766	0.207	2.62652	0.2285	3.32651
0.1645	2.27646	0.186	14.5023	0.2075	3.15153	0.229	3.50148
0.165	2.27646	0.1865	13.9794	0.208	3.15153	0.2295	3.32651
0.1655	2.27646	0.187	13.6308	0.2085	3.15153	0.23	3.32651
0.166	2.27646	0.1875	13.2822	0.209	3.15153	0.2305	3.15153
0.1665	2.10142	0.188	12.9334	0.2095	3.50148	0.231	2.80154
0.167	1.75129	0.1885	12.7591	0.21	3.50148	0.2315	2.62652
0.1675	1.57621	0.189	12.7591	0.2105	3.15153	0.232	2.27646
0.168	1.40112	0.1895	12.4103	0.211	3.15153	0.2325	2.10142
0.1685	1.22602	0.19	12.0615	0.2115	3.15153	0.233	2.10142
0.169	1.40112	0.1905	11.7126	0.212	3.15153	0.2335	2.10142
0.1695	1.57621	0.191	11.5381	0.2125	3.15153	0.234	2.10142
0.17	2.80154	0.1915	11.0147	0.213	3.50148	0.2345	2.27646
0.1705	4.37616	0.192	9.96759	0.2135	4.02632	0.235	2.27646
0.171	4.90084	0.1925	9.44387	0.214	4.02632	0.2355	2.27646
0.1715	4.55106	0.193	9.09467	0.2145	4.55106	0.236	0.700649
0.172	4.37616	0.1935	9.09467	0.215	4.20125	0.2365	7.52273
0.1725	4.72596	0.194	8.92006	0.2155	3.67644	0.237	7.69743
0.173	4.37616	0.1945	8.57079	0.216	3.67644	0.2375	5.77508
0.1735	3.85139	0.195	8.04681	0.2165	3.50148	0.238	4.72596
0.174	3.50148	0.1955	7.34801	0.217	3.85139	0.2385	3.85139
0.1745	4.20125	0.196	6.8238	0.2175	4.02632	0.239	2.97654
0.175	6.1247	0.1965	6.1247	0.218	4.02632	0.2395	2.4515
0.1755	8.22148	0.197	5.94989	0.2185	4.02632		
0.176	11.1892	0.1975	5.07571	0.219	3.85139		
0.1765	14.1537	0.198	4.90084	0.2195	3.67644		
0.177	15.7219	0.1985	4.55106	0.22	3.50148		
0.1775	16.941	0.199	4.02632	0.2205	3.67644		
0.178	18.1595	0.1995	3.50148	0.221	3.32651		
0.1785	19.2035	0.2	3.15153	0.2215	3.32651		
0.179	19.7254	0.2005	3.32651	0.222	3.15153		
0.1795	20.0733	0.201	2.80154	0.2225	3.32651		
0.18	19.3775	0.2015	2.62652	0.223	3.15153		
0.1805	18.5076	0.202	2.97654	0.2235	3.67644		
0.181	18.5076	0.2025	2.62652	0.224	3.50148		
0.1815	18.8556	0.203	2.4515	0.2245	3.32651		

Gauge31_1 Time msec	Gauge31_1 Stress MPa	Gauge31_1 Time msec	Gauge31_1 Stress MPa	Gauge31_1 Time msec	Gauge31_1 Stress MPa	Gauge31_2 Time msec	Gauge31_2 Stress MPa	Gauge31_2 Time msec	Gauge31_2 Stress MPa
-0.018	8.44886	0.0035	235.636	0.025	25.2773	-0.0065	-2.10301	0.015	-3.1551
-0.0175	8.44886	0.004	188.478	0.0255	33.6568	-0.006	-1.92769	0.0155	-1.92769
-0.017	8.44886	0.0045	164.587	0.026	66.9439	-0.0055	-0.876059	0.016	-0.17519
-0.0165	8.44886	0.005	172.574	0.0265	108.033	-0.005	0	0.0165	0.875784
-0.016	8.44886	0.0055	180.537	0.027	108.033	-0.0045	0.175179	0.017	0.350347
-0.0155	8.44886	0.006	220.009	0.0275	124.307	-0.004	-0.525603	0.0175	-0.876059
-0.015	8.44886	0.0065	188.478	0.028	108.033	-0.0035	-1.0513	0.018	-1.40183
-0.0145	8.44886	0.007	204.289	0.0285	83.4488	-0.003	-0.876059	0.0185	-1.22656
-0.014	8.44886	0.0075	164.587	0.029	58.6568	-0.0025	-0.700825	0.019	-0.700825
-0.0135	8.44886	0.008	124.307	0.0295	66.9439	-0.002	-0.525603	0.0195	-0.350391
-0.013	8.44886	0.0085	75.2079	0.03	58.6568	-0.0015	-0.525603	0.02	-0.876059
-0.0125	8.44886	0.009	42.0132	0.0305	58.6568	-0.001	-0.700825	0.0205	-0.876059
-0.012	8.44886	0.0095	0	0.031	50.3465	-0.0005	-0.876059	0.021	-0.525603
-0.0115	16.8746	0.01	8.44886	0.0315	42.0132	0	-0.525603	0.0215	-0.17519
-0.011	-16.967	0.0105	58.6568			0.0005	-1.75239	0.022	-0.525603
-0.0105	-8.47196	0.011	66.9439			0.001	-3.6813	0.0225	-1.57711
-0.01	-8.47196	0.0115	75.2079			0.0015	4.02632	0.023	-1.57711
-0.0095	-8.47196	0.012	91.6666			0.002	4.55106	0.0235	-0.350391
-0.009	-8.47196	0.0125	91.6666			0.0025	-2.62901	0.024	-0.350391
-0.0085	0	0.013	58.6568			0.003	-3.85672	0.0245	-1.22656
-0.008	0	0.0135	8.44886			0.0035	0.700649	0.025	-1.0513
-0.0075	0	0.014	0			0.004	2.97654	0.0255	-0.350391
-0.007	0	0.0145	0			0.0045	-0.17519	0.026	-0.876059
-0.0065	0	0.015	-8.47196			0.005	-1.92769	0.0265	-2.27833
-0.006	0	0.0155	0			0.0055	-0.350391	0.027	-2.45366
-0.0055	0	0.016	0			0.006	1.22602	0.0275	2.62652
-0.005	-8.47196	0.0165	16.8746			0.0065	0.350347	0.028	3.15153
-0.0045	0	0.017	0			0.007	-0.876059	0.0285	-1.57711
-0.004	0	0.0175	-42.5909			0.0075	-0.525603	0.029	-1.40183
-0.0035	0	0.018	-94.4625			0.008	0.525503	0.0295	0.175179
-0.003	0	0.0185	-94.4625			0.0085	0.700649	0.03	-1.544E-13
-0.0025	0	0.019	-59.789			0.009	1.75129	0.0305	-1.0513
-0.002	0	0.0195	0			0.0095	0.525503	0.031	-0.525603
-0.0015	0	0.02	8.44886			0.01	-1.57711	0.0315	0.525503
-0.001	0	0.0205	33.6568			0.0105	-2.62901	0.032	0.875784
-0.0005	16.8746	0.021	25.2773			0.011	-2.97973	0.0325	-0.17519
0	25.2773	0.0215	8.44886			0.0115	0.175179	0.033	-0.700825
0.0005	490.251	0.022	33.6568			0.012	3.67644	0.0335	-0.525603
0.001	490.251	0.0225	33.6568			0.0125	0.700649	0.034	-0.350391
0.0015	500.422	0.023	8.44886			0.013	-2.27833	0.0345	0.525503
0.002	500.422	0.0235	25.2773			0.0135	0.700649	0.035	0.700649
0.0025	350.766	0.024	33.6568			0.014	1.92636	0.0355	-0.17519
0.003	318.052	0.0245	25.2773			0.0145	-1.40183	0.036	-0.876059

GaugeJ1_2 Time msec	GaugeJ1_2 Stress MPa	GaugeJ1_2 Time msec	GaugeJ1_2 Stress MPa	GaugeJ1_2 Time msec	GaugeJ1_2 Stress MPa	GaugeJ1_4 Time msec	GaugeJ1_4 Stress MPa	GaugeJ1_4 Time msec	GaugeJ1_4 Stress MPa
0.0365	-0.700825	0.058	1.57621	0.0795	-7.54312	0.0045	-0.525603	0.026	0.175179
0.037	-0.17519	0.0585	1.57621	0.08	-8.07015	0.005	-0.525603	0.0265	0.175179
0.0375	0	0.059	1.75129	0.0805	-8.24584	0.0055	-0.525603	0.027	0.175179
0.038	-0.17519	0.0595	1.57621	0.081	-8.42155	0.006	-0.350391	0.0275	0.525503
0.0385	0.350347	0.06	1.40112	0.0815	-7.71879	0.0065	-0.525603	0.028	0.525503
0.039	0.875784	0.0605	1.05091	0.082	-7.19183	0.007	-0.350391	0.0285	0.525503
0.0395	0.700649	0.061	0.875784	0.0825	-6.31378	0.0075	-0.350391	0.029	0.525503
0.04	0.175179	0.0615	1.22602	0.083	-5.78709	0.008	-0.17519	0.0295	0.700649
0.0405	-0.350391	0.062	1.57621	0.0835	-5.43601	0.0085	-0.17519	0.03	0.875784
0.041	-0.350391	0.0625	0.700649	0.084	-5.61154	0.009	-0.525603	0.0305	0.700649
0.0415	0.700649	0.063	0.525503	0.0845	-5.78709	0.0095	-0.525603	0.031	1.05091
0.042	1.92636	0.0635	0.525503	0.085	-6.31378	0.01	-0.350391	0.0315	0.875784
0.0425	0.525503	0.064	1.05091	0.0855	-6.84058	0.0105	-0.525603	0.032	0.875784
0.043	-0.525603	0.0645	0.700649	0.086	-7.19183	0.011	-0.350391	0.0325	0.875784
0.0435	0	0.065	0.175179	0.0865	-7.36747	0.0115	-0.350391	0.033	0.875784
0.044	0.525503	0.0655	0.175179	0.087	-7.54312	0.012	-0.525603	0.0335	0.700649
0.0445	1.22602	0.066	0.175179	0.0875	-7.89446	0.0125	-0.525603	0.034	0.700649
0.045	0.875784	0.0665	0.175179			0.013	-0.525603	0.0345	0.525503
0.0455	0.525503	0.067	0.525503			0.0135	-0.525603	0.035	0.525503
0.046	0	0.0675	0.175179			0.014	-0.350391	0.0355	0.525503
0.0465	0.175179	0.068	0.175179			0.0145	-0.525603	0.036	0.350347
0.047	0.875784	0.0685	0.350347			0.015	-0.17519	0.0365	0.350347
0.0475	1.57621	0.069	0.350347			0.0155	-0.525603	0.037	0.175179
0.048	1.75129	0.0695	0.350347			0.016	-0.350391	0.0375	0.350347
0.0485	1.75129	0.07	0.525503			0.0165	0	0.038	0.175179
0.049	1.75129	0.0705	0.700649			0.017	-0.17519	0.0385	0.175179
0.0495	2.27646	0.071	0.875784			0.0175	0.350347	0.039	0.175179
0.05	2.62652	0.0715	1.40112			0.018	0.875784	0.0395	0.175179
0.0505	2.62652	0.072	1.75129			0.0185	-0.17519	0.04	0.175179
0.051	2.4515	0.0725	2.10142			0.019	-0.700825	0.0405	0.175179
0.0515	2.27646	0.073	2.4515			0.0195	-0.17519	0.041	0.175179
0.052	2.27646	0.0735	2.97654			0.02	-0.17519	0.0415	0
0.0525	2.62652	0.074	3.15153			0.0205	0	0.042	0.175179
0.053	2.62652	0.0745	3.50148			0.021	0	0.0425	-0.17519
0.0535	2.4515	0.075	3.15153			0.0215	0	0.043	-0.17519
0.054	2.10142	0.0755	2.80154			0.022	0	0.0435	0
0.0545	2.10142	0.076	2.80154			0.0225	0	0.044	-0.525603
0.055	2.27646	0.0765	2.10142			0.023	0	0.0445	-0.17519
0.0555	2.27646	0.077	0.525503			0.0235	0	0.045	-0.350391
0.056	2.10142	0.0775	-2.45366			0.024	-0.17519	0.0455	-0.525603
0.0565	1.92636	0.078	-3.85672			0.0245	0	0.046	-0.350391
0.057	1.75129	0.0785	-5.26049			0.025	0	0.0465	-0.350391
0.0575	1.40112	0.079	-7.0162			0.0255	0	0.047	-0.350391

GaugeJ1_4 Time msec	GaugeJ1_4 Stress MPa	GaugeJ1_4 Time msec	GaugeJ1_4 Stress MPa	GaugeJ1_4 Time msec	GaugeJ1_4 Stress MPa	GaugeJ1_4 Time msec	GaugeJ1_4 Stress MPa	GaugeJ1_4 Time msec	GaugeJ1_4 Stress MPa
0.0475	-0.350391	0.069	0.700649	0.0905	-1.22656	0.112	1.22602	0.1335	2.62652
0.048	-0.700825	0.0695	0.700649	0.091	-1.0513	0.1125	1.22602	0.134	2.4515
0.0485	-0.350391	0.07	0.700649	0.0915	-1.22656	0.113	1.40112	0.1345	2.62652
0.049	-0.350391	0.0705	0.525503	0.092	-1.0513	0.1135	1.40112	0.135	2.4515
0.0495	-0.350391	0.071	0.525503	0.0925	-1.22656	0.114	1.40112	0.1355	2.27646
0.05	-0.525603	0.0715	0.525503	0.093	-1.22656	0.1145	1.57621	0.136	2.10142
0.0505	-0.525603	0.072	0.525503	0.0935	-1.0513	0.115	1.57621	0.1365	2.10142
0.051	-0.700825	0.0725	0.350347	0.094	-1.22656	0.1155	1.57621	0.137	2.27646
0.0515	-0.700825	0.073	0.700649	0.0945	-1.0513	0.116	1.75129	0.1375	1.92636
0.052	-0.350391	0.0735	0.525503	0.095	-1.22656	0.1165	1.75129	0.138	1.92636
0.0525	-0.700825	0.074	0.700649	0.0955	-1.0513	0.117	1.92636	0.1385	1.75129
0.053	-0.525603	0.0745	0.525503	0.096	-1.0513	0.1175	1.75129	0.139	1.92636
0.0535	-0.700825	0.075	1.05091	0.0965	-0.876059	0.118	1.75129	0.1395	1.75129
0.054	-0.350391	0.0755	0.525503	0.097	-0.525603	0.1185	1.92636	0.14	1.57621
0.0545	-0.700825	0.076	0.525503	0.0975	-0.525603	0.119	1.92636	0.1405	1.22602
0.055	-0.350391	0.0765	0.525503	0.098	-0.350391	0.1195	1.92636	0.141	0.875784
0.0555	-0.525603	0.077	0.350347	0.0985	-0.17519	0.12	2.27646	0.1415	-0.350391
0.056	-0.525603	0.0775	0.350347	0.099	0	0.1205	2.27646	0.142	-1.22656
0.0565	-0.700825	0.078	0.350347	0.0995	0.175179	0.121	2.10142		
0.057	-0.350391	0.0785	0.525503	0.1	0.175179	0.1215	2.10142		
0.0575	-0.525603	0.079	0.525503	0.1005	0.350347	0.122	2.27646		
0.058	-0.350391	0.0795	0.350347	0.101	0.350347	0.1225	2.27646		
0.0585	-0.525603	0.08	0.525503	0.1015	0.350347	0.123	2.62652		
0.059	-0.525603	0.0805	0.700649	0.102	0.700649	0.1235	2.27646		
0.0595	-0.350391	0.081	0.700649	0.1025	0.700649	0.124	2.4515		
0.06	-0.17519	0.0815	0.700649	0.103	0.875784	0.1245	2.10142		
0.0605	-0.17519	0.082	0.525503	0.1035	0.875784	0.125	1.92636		
0.061	0	0.0825	0.700649	0.104	0.700649	0.1255	1.92636		
0.0615	-0.17519	0.083	0.525503	0.1045	1.05091	0.126	1.92636		
0.062	-0.17519	0.0835	0.525503	0.105	0.700649	0.1265	1.92636		
0.0625	0.175179	0.084	0.700649	0.1055	0.700649	0.127	2.10142		
0.063	0.175179	0.0845	0.525503	0.106	0.525503	0.1275	2.10142		
0.0635	0.525503	0.085	0.350347	0.1065	0.525503	0.128	2.4515		
0.064	0.525503	0.0855	0.350347	0.107	0.700649	0.1285	2.62652		
0.0645	0.525503	0.086	0.525503	0.1075	0.525503	0.129	2.62652		
0.065	0.525503	0.0865	0.350347	0.108	0.525503	0.1295	2.62652		
0.0655	0.525503	0.087	0.175179	0.1085	0.700649	0.13	2.80154		
0.066	0.525503	0.0875	0.175179	0.109	0.525503	0.1305	2.80154		
0.0665	0.700649	0.088	0	0.1095	0.875784	0.131	2.80154		
0.067	0.700649	0.0885	0	0.11	0.875784	0.1315	2.97654		
0.0675	0.525503	0.089	0.350347	0.1105	0.875784	0.132	2.62652		
0.068	0.525503	0.0895	-0.17519	0.111	1.05091	0.1325	2.97654		
0.0685	0.525503	0.09	-1.0513	0.1115	1.22602	0.133	2.80154		

Gauge31_5 Time msec	Gauge31_5 Stress MPa	Gauge31_5 Time msec	Gauge31_5 Stress MPa	Gauge31_5 Time msec	Gauge31_5 Stress MPa	Gauge31_5 Time msec	Gauge31_5 Stress MPa	Gauge31_5 Time msec	Gauge31_5 Stress MPa
0.1075	0.350347	0.129	0.175179	0.1505	-7.54312	0.172	-7.71879	0.1935	-10.7068
0.108	0.175179	0.1295	0.175179	0.151	-8.42155	0.1725	-7.71879	0.194	-10.5309
0.1085	0.175179	0.13	0.175179	0.1515	-8.94874	0.173	-7.36747	0.1945	-10.3551
0.109	0.350347	0.1305	0.175179	0.152	-9.65182	0.1735	-7.36747	0.195	-10.1792
0.1095	0.175179	0.131	0.525503	0.1525	-10.1792	0.174	-7.36747	0.1955	-9.47603
0.11	0.175179	0.1315	0.175179	0.153	-10.7068	0.1745	-6.48937	0.196	-9.30026
0.1105	0.350347	0.132	0	0.1535	-11.2344	0.175	-6.48937	0.1965	-8.94874
0.111	0.175179	0.1325	0.175179	0.154	-11.7621	0.1755	-6.66497	0.197	-8.94874
0.1115	0.350347	0.133	0.175179	0.1545	-11.7621	0.176	-6.48937	0.1975	-8.59727
0.112	0.175179	0.1335	0.175179	0.155	-12.114	0.1765	-6.48937	0.198	-8.59727
0.1125	0.350347	0.134	0.175179	0.1555	-12.2899	0.177	-6.13821	0.1985	-8.24584
0.113	0.350347	0.1345	0	0.156	-12.6419	0.1775	-6.13821	0.199	-8.07015
0.1135	0.175179	0.135	0	0.1565	-12.6419	0.178	-6.13821	0.1995	-7.89446
0.114	0.350347	0.1355	0	0.157	-12.6419	0.1785	-5.96264	0.2	-7.54312
0.1145	0.350347	0.136	-0.17519	0.1575	-12.8178	0.179	-5.78709	0.2005	-7.54312
0.115	0.525503	0.1365	-0.350391	0.158	-12.6419	0.1795	-5.61154	0.201	-7.54312
0.1155	0.350347	0.137	-0.17519	0.1585	-12.6419	0.18	-5.61154	0.2015	-7.0162
0.116	0.525503	0.1375	-0.525603	0.159	-12.4659	0.1805	-5.43601	0.202	-6.84058
0.1165	0.175179	0.138	-0.525603	0.1595	-12.2899	0.181	-5.78709	0.2025	-6.48937
0.117	0.525503	0.1385	-0.17519	0.16	-12.114	0.1815	-6.13821	0.203	-6.31378
0.1175	0.350347	0.139	-0.350391	0.1605	-11.7621	0.182	-6.48937	0.2035	-6.13821
0.118	0.175179	0.1395	0	0.161	-11.7621	0.1825	-6.84058	0.204	-5.96264
0.1185	0.350347	0.14	0.175179	0.1615	-11.4103	0.183	-7.36747	0.2045	-5.61154
0.119	0.175179	0.1405	0.700649	0.162	-11.4103	0.1835	-7.36747	0.205	-5.78709
0.1195	0.700649	0.141	1.40112	0.1625	-11.0585	0.184	-7.71879	0.2055	-5.43601
0.12	0.175179	0.1415	2.4515	0.163	-11.0585	0.1845	-8.07015	0.206	-5.43601
0.1205	0.525503	0.142	3.15153	0.1635	-10.8826	0.185	-8.42155	0.2065	-5.43601
0.121	0.175179	0.1425	3.85139	0.164	-10.7068	0.1855	-8.773	0.207	-5.26049
0.1215	0.175179	0.143	4.20125	0.1645	-10.0034	0.186	-8.94874	0.2075	-5.08498
0.122	0	0.1435	4.72596	0.165	-10.0034	0.1865	-9.47603	0.208	-4.734
0.1225	0.525503	0.144	4.37616	0.1655	-9.1245	0.187	-9.65182	0.2085	-4.90948
0.123	0.350347	0.1445	4.02632	0.166	-8.94874	0.1875	-10.1792	0.209	-4.90948
0.1235	0.350347	0.145	3.50148	0.1665	-9.1245	0.188	-10.3551	0.2095	-4.90948
0.124	0	0.1455	2.62652	0.167	-9.1245	0.1885	-10.5309	0.21	-5.08498
0.1245	0	0.146	1.75129	0.1675	-8.94874	0.189	-10.5309	0.2105	-4.90948
0.125	0	0.1465	0.525503	0.168	-9.1245	0.1895	-10.5309	0.211	-4.90948
0.1255	0.350347	0.147	-0.700825	0.1685	-8.773	0.19	-10.7068	0.2115	-5.08498
0.126	-0.17519	0.1475	-1.92769	0.169	-8.42155	0.1905	-10.5309	0.212	-4.90948
0.1265	0	0.148	-2.80436	0.1695	-8.24584	0.191	-10.5309	0.2125	-5.26049
0.127	-0.17519	0.1485	-3.85672	0.17	-7.89446	0.1915	-10.7068	0.213	-5.08498
0.1275	0.525503	0.149	-4.734	0.1705	-8.07015	0.192	-10.7068	0.2135	-5.26049
0.128	0.175179	0.1495	-5.96264	0.171	-7.89446	0.1925	-10.7068	0.214	-5.26049
0.1285	-0.17519	0.15	-7.0162	0.1715	-7.89446	0.193	-10.7068	0.2145	-5.61154

Gauge31_5 Time msec	Gauge31_5 Stress MPa	Gauge31_6 Time msec	Gauge31_6 Stress MPa	Gauge31_6 Time msec	Gauge31_6 Stress MPa	Gauge31_6 Time msec	Gauge31_6 Stress MPa	Gauge31_6 Time msec	Gauge31_6 Stress MPa
0.215	-5.96264	-0.018	-0.525603	0.0035	0.175179	0.025	0.175179	0.0465	-0.17519
0.2155	-6.13821	-0.0175	-0.350391	0.004	0	0.0255	0	0.047	0
0.216	-6.13821	-0.017	-0.525603	0.0045	0.175179	0.026	0.175179	0.0475	-0.17519
0.2165	-6.48937	-0.0165	-0.525603	0.005	0.175179	0.0265	-0.17519	0.048	0
0.217	-6.48937	-0.016	-0.525603	0.0055	0.175179	0.027	-0.17519	0.0485	0
0.2175	-6.48937	-0.0155	-0.350391	0.006	0	0.0275	-0.17519	0.049	0
0.218	-6.84058	-0.015	-0.525603	0.0065	0	0.028	-0.17519	0.0495	0
0.2185	-6.66497	-0.0145	-0.525603	0.007	0.175179	0.0285	0	0.05	0.175179
0.219	-6.84058	-0.014	-0.525603	0.0075	0.175179	0.029	-0.17519	0.0505	0.175179
0.2195	-7.19183	-0.0135	-0.350391	0.008	0.175179	0.0295	0	0.051	0.175179
0.22	-7.36747	-0.013	-0.350391	0.0085	0.175179	0.03	0	0.0515	0.175179
0.2205	-7.89446	-0.0125	-0.525603	0.009	0.175179	0.0305	0	0.052	0.175179
0.221	-7.71879	-0.012	-0.700825	0.0095	0.350347	0.031	0.175179	0.0525	0
0.2215	-8.07015	-0.0115	-0.525603	0.01	0.175179	0.0315	-1.544E-13	0.053	0.175179
0.222	-8.42155	-0.011	-0.350391	0.0105	0.175179	0.032	0	0.0535	0.175179
0.2225	-8.42155	-0.0105	-0.525603	0.011	-1.544E-13	0.0325	0.175179	0.054	0.175179
0.223	-8.773	-0.01	-1.22656	0.0115	-0.17519	0.033	0.175179	0.0545	0.350347
0.2235	-8.773	-0.0095	-7.89446	0.012	0	0.0335	0	0.055	0.350347
0.224	-8.94874	-0.009	-20.0427	0.0125	0.034	0.034	0	0.0555	0.350347
0.2245	-8.94874	-0.0085	-9.1245	0.013	0	0.0345	0	0.056	0.350347
0.225	-9.1245	-0.008	1.75129	0.0135	0	0.035	0.175179	0.0565	0.350347
0.2255	-9.1245	-0.0075	10.1421	0.014	0	0.0355	0	0.057	0.525503
0.226	-9.47603	-0.007	6.8238	0.0145	0	0.036	0	0.0575	0.525503
0.2265	-9.47603	-0.0065	4.72596	0.015	-1.544E-13	0.0365	0.350347	0.058	0.525503
0.227	-9.30026	-0.006	0.525503	0.0155	-0.17519	0.037	0.175179	0.0585	0.525503
0.2275	-9.30026	-0.0055	-2.27833	0.016	-0.17519	0.0375	0.175179	0.059	0.700649
		-0.005	6.2238E-13	0.0165	0.175179	0.038	0.175179	0.0595	0.525503
		-0.0045	1.05091	0.017	0	0.0385	0.350347	0.06	0.525503
		-0.004	1.05091	0.0175	0	0.039	0.175179	0.0605	0.700649
		-0.0035	0	0.018	0	0.0395	0.175179	0.061	0.525503
		-0.003	0.350347	0.0185	0	0.04	0.350347	0.0615	0.700649
		-0.0025	0.175179	0.019	-1.544E-13	0.0405	-0.17519	0.062	0.525503
		-0.002	0.175179	0.0195	0	0.041	0.175179	0.0625	0.525503
		-0.0015	0.175179	0.02	-0.17519	0.0415	0.175179	0.063	0.525503
		-0.001	0.175179	0.0205	0	0.042	0	0.0635	0.525503
		-0.0005	0.175179	0.021	0	0.0425	0	0.064	0.525503
		0	0.175179	0.0215	0	0.043	-0.17519	0.0645	0.525503
		0.0005	0	0.022	0	0.0435	-1.544E-13	0.065	0.525503
		0.001	0	0.0225	0.350347	0.044	0	0.0655	0.525503
		0.0015	0.175179	0.023	0.875784	0.0445	0.350347	0.066	0.525503
		0.002	0.350347	0.0235	-0.17519	0.045	-0.17519	0.0665	0.700649
		0.0025	0.175179	0.024	-0.525603	0.0455	-0.17519	0.067	0.525503
		0.003	0.175179	0.0245	-0.17519	0.046	-0.17519	0.0675	0.700649

Gauge31_6 Time msec	Gauge31_6 Stress MPa	Gauge31_6 Time msec	Gauge31_6 Stress MPa	Gauge31_6 Time msec	Gauge31_6 Stress MPa	Gauge31_6 Time msec	Gauge31_6 Stress MPa	Gauge31_6 Time msec	Gauge31_6 Stress MPa
0.068	0.700649	0.0895	0.175179	0.111	0.350347	0.1325	1.05091	0.154	1.05091
0.0685	0.700649	0.09	0	0.1115	0.700649	0.133	1.05091	0.1545	0.350347
0.069	0.525503	0.0905	0.175179	0.112	0.525503	0.1335	0.875784	0.155	-0.17519
0.0695	0.700649	0.091	0.350347	0.1125	0.525503	0.134	1.05091	0.1555	-1.0513
0.07	0.525503	0.0915	0.175179	0.113	0.700649	0.1345	1.05091	0.156	-1.57711
0.0705	0.525503	0.092	0.175179	0.1135	0.525503	0.135	1.40112	0.1565	-1.75239
0.071	0.525503	0.0925	0.175179	0.114	0.700649	0.1355	1.05091	0.157	-2.27833
0.0715	0.350347	0.093	0.175179	0.1145	0.525503	0.136	1.05091	0.1575	-2.62901
0.072	0.525503	0.0935	0.350347	0.115	0.875784	0.1365	1.05091	0.158	-2.80436
0.0725	0.350347	0.094	0.875784	0.1155	0.525503	0.137	0.875784	0.1585	-2.62901
0.073	0.350347	0.0945	0.525503	0.116	0.700649	0.1375	0.875784	0.159	-2.45366
0.0735	0.525503	0.095	-0.350391	0.1165	0.700649	0.138	0.700649	0.1595	-2.10301
0.074	0.350347	0.0955	1.5435E-13	0.117	0.700649	0.1385	0.525503	0.16	-1.92769
0.0745	0.525503	0.096	1.5435E-13	0.1175	0.700649	0.139	0	0.1605	-1.22656
0.075	0.175179	0.0965	0.175179	0.118	0.700649	0.1395	-0.17519	0.161	-0.876059
0.0755	0.350347	0.097	0.175179	0.1185	0.700649	0.14	-0.350391	0.1615	-0.17519
0.076	0.175179	0.0975	0	0.119	0.700649	0.1405	-0.700825	0.162	0
0.0765	0.175179	0.098	0	0.1195	0.525503	0.141	-1.0513	0.1625	0.350347
0.077	0.350347	0.0985	0	0.12	0.700649	0.1415	-1.22656	0.163	0.525503
0.0775	0	0.099	0	0.1205	0.700649	0.142	-1.57711	0.1635	0.700649
0.078	0.175179	0.0995	-0.17519	0.121	0.525503	0.1425	-1.75239	0.164	0.875784
0.0785	0.175179	0.1	-0.350391	0.1215	0.700649	0.143	-1.75239	0.1645	0.875784
0.079	0.175179	0.1005	-0.350391	0.122	0.525503	0.1435	-1.92769	0.165	1.05091
0.0795	0.175179	0.101	-0.350391	0.1225	0.700649	0.144	-2.27833	0.1655	0.875784
0.08	1.5435E-13	0.1015	-0.350391	0.123	0.875784	0.1445	-1.92769	0.166	0.875784
0.0805	0.175179	0.102	-0.876059	0.1235	0.700649	0.145	-2.10301	0.1665	0.700649
0.081	0	0.1025	-0.350391	0.124	0.875784	0.1455	-1.75239	0.167	0.875784
0.0815	0	0.103	-0.700825	0.1245	1.05091	0.146	-1.75239	0.1675	0.875784
0.082	0	0.1035	-0.700825	0.125	1.05091	0.1465	-1.40183	0.168	0.875784
0.0825	0	0.104	-0.350391	0.1255	0.700649	0.147	-1.0513	0.1685	0.700649
0.083	-1.544E-13	0.1045	-0.525603	0.126	0.700649	0.1475	-0.700825	0.169	0.700649
0.0835	-0.17519	0.105	-0.350391	0.1265	0.700649	0.148	-0.17519	0.1695	0.875784
0.084	-1.544E-13	0.1055	-0.350391	0.127	0.700649	0.1485	0.350347	0.17	0.875784
0.0845	0	0.106	-0.350391	0.1275	0.875784	0.149	0.700649	0.1705	0.875784
0.085	-0.17519	0.1065	-0.17519	0.128	0.875784	0.1495	1.05091	0.171	0.700649
0.0855	0	0.107	-0.17519	0.1285	0.875784	0.15	1.40112	0.1715	0.525503
0.086	-0.17519	0.1075	-0.17519	0.129	1.05091	0.1505	1.57621	0.172	0.175179
0.0865	0	0.108	0	0.1295	1.05091	0.151	1.75129	0.1725	0.175179
0.087	0.350347	0.1085	0	0.13	0.875784	0.1515	1.92636	0.173	0.17519
0.0875	0	0.109	0	0.1305	0.875784	0.152	2.10142	0.1735	-0.350391
0.088	0	0.1095	0	0.131	0.875784	0.1525	1.92636	0.174	-0.17519
0.0885	0	0.11	0.175179	0.1315	0.875784	0.153	1.57621	0.1745	-0.350391
0.089	0.175179	0.1105	0.350347	0.132	1.05091	0.1535	1.57621	0.175	0

Gauge31_6 Time msec	Gauge31_6 Stress MPa	Gauge31_6 Time msec	Gauge31_6 Stress MPa	Gauge31_6 Time msec	Gauge31_6 Stress MPa	Gauge31_6 Time msec	Gauge31_6 Stress MPa	Gauge31_6 Time msec	Gauge31_6 Stress MPa
0.1755	-0.17519	0.197	-0.700825	0.2185	-0.700825	0.24	-2.80436	0.2615	-0.700825
0.176	0	0.1975	-0.876059	0.219	-0.525603	0.2405	-2.10301	0.262	-0.876059
0.1765	0.175179	0.198	-0.876059	0.2195	-0.17519	0.241	-1.92769	0.2625	-0.525603
0.177	0.525503	0.1985	-0.525603	0.22	1.5435E-13	0.2415	-1.75239	0.263	-0.700825
0.1775	0.875784	0.199	-0.350391	0.2205	0.350347	0.242	-1.57711	0.2635	-0.525603
0.178	0.875784	0.1995	0	0.221	0.875784	0.2425	-1.40183	0.264	-0.700825
0.1785	1.05091	0.2	0.175179	0.2215	1.05091	0.243	-1.40183	0.2645	-0.525603
0.179	0.875784	0.2005	0.525503	0.222	1.40112	0.2435	-1.57711	0.265	-0.525603
0.1795	0.700649	0.201	0.525503	0.2225	1.57621	0.244	-1.22656	0.2655	-0.700825
0.18	0.350347	0.2015	0.700649	0.223	1.75129	0.2445	-1.22656	0.266	-0.525603
0.1805	-0.17519	0.202	0.875784	0.2235	1.92636	0.245	-1.40183	0.2665	-0.525603
0.181	-0.17519	0.2025	0.875784	0.224	1.92636	0.2455	-1.0513	0.267	-0.525603
0.1815	-0.700825	0.203	0.875784	0.2245	1.75129	0.246	-1.0513	0.2675	-0.525603
0.182	-1.0513	0.2035	0.875784	0.225	1.75129	0.2465	-0.876059	0.268	-0.700825
0.1825	-1.0513	0.204	0.700649	0.2255	1.57621	0.247	-1.0513	0.2685	-0.700825
0.183	-1.0513	0.2045	0.875784	0.226	1.92636	0.2475	-0.876059	0.269	-0.700825
0.1835	-1.40183	0.205	0.700649	0.2265	1.92636	0.248	-0.876059	0.2695	-0.525603
0.184	-1.57711	0.2055	0.875784	0.227	2.10142	0.2485	-0.876059	0.27	-0.525603
0.1845	-1.57711	0.206	0.875784	0.2275	2.10142	0.249	-0.876059	0.2705	-0.525603
0.185	-1.57711	0.2065	0.875784	0.228	2.62652	0.2495	-0.876059	0.271	-0.700825
0.1855	-1.40183	0.207	1.05091	0.2285	2.4515	0.25	-0.876059	0.2715	-0.700825
0.186	-1.0513	0.2075	1.05091	0.229	2.27646	0.2505	-0.876059	0.272	-0.525603
0.1865	-0.700825	0.208	1.05091	0.2295	2.10142	0.251	-0.876059	0.2725	-0.525603
0.187	-0.17519	0.2085	1.22602	0.23	1.57621	0.2515	-0.876059	0.273	-0.525603
0.1875	0.175179	0.209	1.40112	0.2305	0.875784	0.252	-0.876059	0.2735	-0.525603
0.188	0.700649	0.2095	1.75129	0.231	0.700649	0.2525	-0.876059	0.274	-0.525603
0.1885	0.875784	0.21	1.57621	0.2315	-0.17519	0.253	-0.876059	0.2745	-0.525603
0.189	1.22602	0.2105	1.57621	0.232	-0.876059	0.2535	-0.876059	0.275	-0.700825
0.1895	1.92636	0.211	1.92636	0.2325	-1.22656	0.254	-0.700825	0.2755	-0.700825
0.19	2.10142	0.2115	1.92636	0.233	-1.40183	0.2545	-0.525603	0.276	-0.700825
0.1905	2.4515	0.212	1.92636	0.2335	-1.57711	0.255	-0.876059	0.2765	-0.876059
0.191	3.15153	0.2125	2.10142	0.234	-2.10301	0.2555	-0.876059	0.277	-0.700825
0.1915	3.50148	0.213	1.75129	0.2345	-2.27833	0.256	-0.700825	0.2775	-0.700825
0.192	3.32651	0.2135	1.57621	0.235	-2.62901	0.2565	-0.876059	0.278	-0.700825
0.1925	3.32651	0.214	1.22602	0.2355	-2.97973	0.257	-0.876059	0.2785	-0.525603
0.193	3.15153	0.2145	0.700649	0.236	-3.33049	0.2575	-0.700825	0.279	-0.700825
0.1935	2.4515	0.215	0.175179	0.2365	-4.38305	0.258	-0.700825	0.2795	-0.525603
0.194	1.92636	0.2155	-0.17519	0.237	1.22602	0.2585	-1.0513	0.28	-0.700825
0.1945	1.40112	0.216	-0.525603	0.2375	4.02632	0.259	-0.876059	0.2805	-0.525603
0.195	0.875784	0.2165	-0.525603	0.238	-0.700825	0.2595	-1.0513	0.281	-0.525603
0.1955	0.175179	0.217	-0.876059	0.2385	-4.55852	0.26	-0.700825	0.2815	-0.700825
0.196	0	0.2175	-0.876059	0.239	-3.50589	0.2605	-0.700825	0.282	-0.700825
0.1965	-0.525603	0.218	-0.700825	0.2395	-3.50589	0.261	-0.876059	0.2825	-0.525603

Gauge31_6	Gauge31_6	Gauge31_6	Gauge31_6	Gauge31_6	Gauge31_6	Gauge31_6	Gauge31_6	Gauge31_6	Gauge31_6
Time	Stress	Time	Stress	Time	Stress	Time	Stress	Time	Stress
msec	MPa	msec	MPa	msec	MPa	msec	MPa	msec	MPa
0.283	-0.525603	0.3045	-0.525603	0.326	-0.525603	0.3475	-0.354418	0.369	0.253704
0.2835	-0.525603	0.305	-0.525603	0.3265	-0.350391	0.348	-0.344349	0.3695	0.0885975
0.284	-0.700825	0.3055	-0.17519	0.327	-0.525603	0.3485	-0.33428	0.37	0.273838
0.2845	-0.700825	0.306	-0.525603	0.3275	-0.525603	0.349	-0.324211	0.3705	0.283905
0.285	-0.525603	0.3065	-0.350391	0.328	-0.525603	0.3495	-0.314141	0.371	0.118801
0.2855	-0.525603	0.307	-0.525603	0.3285	-0.525603	0.35	-0.304072	0.3715	0.304039
0.286	-0.700825	0.3075	-0.525603	0.329	-0.525603	0.3505	-0.118806	0.372	-0.912316
0.2865	-0.525603	0.308	-0.525603	0.3295	-0.700825	0.351	-0.283934	0.3725	-
0.287	-0.525603	0.3085	-0.350391	0.33	-0.525603	0.3515	-0.273865	0.373	-0.541715
0.2875	-0.525603	0.309	-0.350391	0.3305	-0.525603	0.352	-0.263796	0.3735	-0.181231
0.288	-0.700825	0.3095	-0.350391	0.331	-0.700825	0.3525	-0.253727	0.374	-0.696797
0.2885	-0.700825	0.31	-0.525603	0.3315	-0.525603	0.353	-0.243658	0.3745	0.0140953
0.289	-0.700825	0.3105	-0.525603	0.332	-0.350391	0.3535	-	0.375	-0.326224
0.2895	-0.525603	0.311	-0.525603	0.3325	-0.350391	0.354	-0.22352	0.3755	0.0342312
0.29	-0.700825	0.3115	-0.525603	0.333	-0.525603	0.3545	-	0.376	-0.306086
0.2905	-0.350391	0.312	-0.525603	0.3335	-0.525603	0.355	-0.203382	0.3765	-0.120819
0.291	-0.525603	0.3125	-0.525603	0.334	-0.525603	0.3555	-0.193314	0.377	-0.110751
0.2915	-0.525603	0.313	-0.525603	0.3345	-0.525603	0.356	-0.183245	0.3775	-0.100682
0.292	-0.525603	0.3135	-0.525603	0.335	-0.525603	0.3565	-0.173176	0.378	-0.090614
0.2925	-0.525603	0.314	-0.525603	0.3355	-0.700825	0.357	0.0120817	0.3785	-
0.293	-0.525603	0.3145	-0.350391	0.336	-0.350391	0.3575	-0.153039	0.379	0.455039
0.2935	-0.350391	0.315	-0.350391	0.3365	-0.700825	0.358	0.0322176	0.3795	0.289945
0.294	-0.525603	0.3155	-0.525603	0.337	-0.525603	0.3585	0.0422855	0.38	-0.751179
0.2945	-0.700825	0.316	-0.350391	0.3375	-0.350391	0.359	0.0523534	0.3805	-0.741108
0.295	-0.700825	0.3165	-0.525603	0.338	-0.525603	0.3595	0.0624213	0.381	-0.906273
0.2955	-0.350391	0.317	-0.525603	0.3385	-0.525603	0.36	0.0724891	0.3815	-0.896202
0.296	-0.525603	0.3175	-0.525603	0.339	-0.525603	0.3605	0.0825569	0.382	-1.23663
0.2965	-0.350391	0.318	-0.525603	0.3395	-0.340321	0.361	0.0926246	0.3825	-0.876059
0.297	-0.525603	0.3185	-0.700825	0.34	-0.330252	0.3615	0.102692	0.383	-1.40183
0.2975	-0.525603	0.319	-0.350391	0.3405	-0.320183	0.362	0.11276	0.3835	-1.22656
0.298	-0.525603	0.3195	-0.525603	0.341	-0.485323	0.3625	0.122828	0.384	-1.57711
0.2985	-0.525603	0.32	-0.350391	0.3415	-0.300044	0.363	0.132895	-	-
0.299	-0.700825	0.3205	-0.525603	0.342	-0.465183	0.3635	-0.032218	-	-
0.2995	-0.525603	0.321	-0.525603	0.3425	-0.279906	0.364	0.15303	-	-
0.3	-0.525603	0.3215	-0.525603	0.343	-0.445044	0.3645	-	-	-
0.3005	-0.525603	0.322	-0.350391	0.3435	-0.434974	0.365	0.173165	-	-
0.301	-0.525603	0.3225	-0.525603	0.344	-0.424905	0.3655	0.0080544	-	-
0.3015	-0.350391	0.323	-0.350391	0.3445	-0.414835	0.366	0.1933	-	-
0.302	-0.525603	0.3235	-0.525603	0.345	-0.404766	0.3665	0.0281904	-	-
0.3025	-0.700825	0.324	-0.525603	0.3455	-0.394696	0.367	0.213435	-	-
0.303	-0.525603	0.3245	-0.525603	0.346	-0.384627	0.3675	0.223502	-	-
0.3035	-0.525603	0.325	-0.525603	0.3465	-0.199355	0.368	0.233569	-	-
0.304	-0.525603	0.3255	-0.350391	0.347	-0.364488	0.3685	0.243636	-	-

Gauge32_1	Gauge32_1	Gauge32_1	Gauge32_1	Gauge32_2	Gauge32_2	Gauge32_2	Gauge32_2	Gauge32_2	Gauge32_2
Time	Stress	Time	Stress	Time	Stress	Time	Stress	Time	Stress
msec	MPa	msec	MPa	msec	MPa	msec	MPa	msec	MPa
-0.014	0	0.0075	191.366	-0.014	1.81286	0.0075	0.725281	0.029	0.906573
-0.0135	0	0.008	117.962	-0.0135	1.81286	0.008	2.1753	0.0295	1.26912
-0.013	0	0.0085	-51.9627	-0.013	1.99408	0.0085	4.34895	0.03	0.906573
-0.0125	0	0.009	25.6646	-0.0125	1.81286	0.009	-0.181349	0.0305	0.906573
-0.012	0	0.0095	109.688	-0.012	1.45038	0.0095	-5.99054	0.031	0.725281
-0.0115	0	0.01	59.5557	-0.0115	1.45038	0.01	-1.99547	0.0315	0.543978
-0.011	8.57834	0.0105	142.641	-0.011	1.63163	0.0105	8.69132	0.032	0.543978
-0.0105	8.57834	0.011	158.977	-0.0105	1.81286	0.011	3.98679	0.0325	0.181337
-0.01	0	0.0115	126.212	-0.01	1.63163	0.0115	-2.17694	0.033	0.181337
-0.0095	0	0.012	42.6571	-0.0095	1.63163	0.012	0	0.0335	0.181337
-0.009	8.57834	0.0125	101.392	-0.009	1.63163	0.0125	-0.181349	0.034	0
-0.0085	0	0.013	17.1332	-0.0085	1.81286	0.013	1.26912	0.0345	-0.181349
-0.008	0	0.0135	-69.4713	-0.008	1.81286	0.0135	3.62458	0.035	-0.362709
-0.0075	0	0.014	-69.4713	-0.0075	1.81286	0.014	-0.544081	0.0355	-0.362709
-0.007	0	0.0145	-158.422	-0.007	1.63163	0.0145	-3.08448	0.036	-0.544081
-0.0065	0	0.015	-95.9102	-0.0065	1.63163	0.015	-1.26968	0.0365	-0.544081
-0.006	0	0.0155	-87.0738	-0.006	1.63163	0.0155	1.08785	0.037	-0.544081
-0.0055	0	0.016	-95.9102	-0.0055	1.63163	0.016	3.08118	0.0375	-0.544081
-0.005	0	0.0165	-43.2436	-0.005	1.45038	0.0165	1.99408	0.038	-0.362709
-0.0045	17.1332	0.017	-69.4713	-0.0045	0.181337	0.017	0.543978	0.0385	-0.544081
-0.004	-25.8758	0.0175	-87.0738	-0.004	4.71106	0.0175	0.362663	0.039	-0.544081
-0.0035	-17.2271	0.018	-43.2436	-0.0035	0.543978	0.018	0.543978	0.0395	-0.362709
-0.003	-8.6018	0.0185	-69.4713	-0.003	-11.6293	0.0185	0.725281	0.04	-0.362709
-0.0025	-8.6018	0.019	-78.2608	-0.0025	-18.3739	0.019	1.08785	0.0405	-0.362709
-0.002	-8.6018	0.0195	-87.0738	-0.002	-5.99054	0.0195	1.26912	0.041	-0.181349
-0.0015	-8.6018	0.02	-122.56	-0.0015	-1.45111	0.02	0.725281	0.0415	0
-0.001	-8.6018	0.0205	-122.56	-0.001	-0.181349	0.0205	0.543978	0.042	0.181337
-0.0005	0	0.021	0	-0.0005	-0.906858	0.021	0.362663	0.0425	0.181337
0	-8.6018	0.0215	0	0	-1.26968	0.0215	1.26912	0.043	0.362663
0.0005	101.392	0.022	0.0005	0.0005	-3.26603	0.022	1.45038	0.0435	0.181337
0.001	207.42	0.0225	0.001	0.001	-1.63255	0.0225	1.08785	0.044	0.181337
0.0015	314.485	0.023	0.0015	0.0015	6.8828	0.023	0.906573	0.0445	0.362663
0.002	382.655	0.0235	0.002	0.002	4.16787	0.0235	0.906573	0.045	0.362663
0.0025	458.674	0.024	0.0025	0.0025	-3.08448	0.024	0.906573	0.0455	0.362663
0.003	448.767	0.0245	0.003	0.003	-1.99547	0.0245	1.26912	0.046	0.181337
0.0035	419.728	0.025	0.0035	0.0035	2.53768	0.025	1.08785	0.0465	0.362663
0.004	382.655	0.0255	0.004	0.004	3.62458	0.0255	0.725281	0.047	0.362663
0.0045	322.552	0.026	0.0045	0.0045	0.543978	0.026	0.725281	0.0475	0.181337
0.005	167.109	0.0265	0.005	0.005	-0.725464	0.0265	1.45038	0.048	0.181337
0.0055	134.438	0.027	0.0055	0.0055	1.08785	0.027	0.906573	0.0485	0.181337
0.006	150.821	0.0275	0.006	0.006	2.3565	0.0275	1.08785	0.049	0.181337
0.0065	291.091	0.028	0.0065	0.0065	1.45038	0.028	1.26912	0.0495	0
0.007	298.753	0.0285	0.007	0.007	-0.181349	0.0285	0.906573	0.05	0



GaugeJ2_2 Time msec	GaugeJ2_2 Stress MPa	GaugeJ2_2 Time msec	GaugeJ2_2 Stress MPa	GaugeJ2_2 Time msec	GaugeJ2_2 Stress MPa	GaugeJ2_2 Time msec	GaugeJ2_2 Stress MPa	GaugeJ2_2 Time msec	GaugeJ2_2 Stress MPa
0.0505	0	0.072	8.51052	0.0935	-10.9011	0.115	-15.0908	0.1365	-15.4554
0.051	0	0.0725	8.69132	0.094	-11.4473	0.1155	-14.9085	0.137	-15.2731
0.0515	0	0.073	8.87211	0.0945	-11.4473	0.116	-14.3617	0.1375	-14.544
0.052	-0.181349	0.0735	8.3297	0.095	-11.4473	0.1165	-13.8151	0.138	-14.3617
0.0525	-0.181349	0.074	7.24459	0.0955	-11.6293	0.117	-13.6328	0.1385	-14.1795
0.053	-0.725464	0.0745	6.34002	0.096	-11.8114	0.1175	-13.6328	0.139	-13.4507
0.0535	-0.362709	0.075	5.43516	0.0965	-12.1756	0.118	-13.6328	0.1395	-13.0863
0.054	-0.362709	0.0755	4.71106	0.097	-12.3577	0.1185	-14.1795	0.14	-12.5399
0.0545	-0.181349	0.076	3.98679	0.0975	-12.722	0.119	-14.3617	0.1405	-11.9935
0.055	-0.362709	0.0765	3.26233	0.098	-12.5399	0.1195	-14.3617	0.141	-11.4473
0.0555	-0.362709	0.077	1.99408	0.0985	-12.1756	0.12	-13.8151	0.1415	-10.7191
0.056	-0.181349	0.0775	0.725281	0.099	-11.8114	0.1205	-13.9973	0.142	-10.1731
0.0565	-0.181349	0.078	-0.906858	0.0995	-11.6293	0.121	-13.6328	0.1425	-9.62722
0.057	-0.181349	0.0785	-2.17694	0.1	-11.6293	0.1215	-13.6328	0.143	-9.26335
0.0575	-0.181349	0.079	-3.44758	0.1005	-11.6293	0.122	-13.2685	0.1435	-8.89952
0.058	-0.362709	0.0795	-4.53715	0.101	-11.8114	0.1225	-13.4507	0.144	-8.71762
0.0585	-0.181349	0.08	-5.44543	0.1015	-12.1756	0.123	-13.4507	0.1445	-8.172
0.059	0	0.0805	-6.53575	0.102	-12.1756	0.1235	-13.9973	0.145	-8.172
0.0595	0.181337	0.081	-7.99015	0.1025	-11.9935	0.124	-13.4507	0.1455	-7.99015
0.06	0	0.0815	-8.89952	0.103	-11.9935	0.1245	-13.6328	0.146	-7.99015
0.0605	0	0.082	-9.44528	0.1035	-11.9935	0.125	-13.6328	0.1465	-7.80831
0.061	0	0.0825	-10.1731	0.104	-12.5399	0.1255	-13.6328	0.147	-7.99015
0.0615	0.181337	0.083	-10.3551	0.1045	-12.722	0.126	-13.4507	0.1475	-7.80831
0.062	0.362663	0.0835	-11.0832	0.105	-13.2685	0.1265	-13.4507	0.148	-8.172
0.0625	0.543978	0.084	-11.6293	0.1055	-13.4507	0.127	-13.8151	0.1485	-8.53574
0.063	0.362663	0.0845	-11.6293	0.106	-13.9973	0.1275	-13.9973	0.149	-8.53574
0.0635	0.362663	0.085	-11.6293	0.1065	-14.3617	0.128	-14.1795	0.1495	-8.53574
0.064	0.181337	0.0855	-11.6293	0.107	-14.1795	0.1285	-13.8151	0.15	-8.71762
0.0645	0.362663	0.086	-11.4473	0.1075	-14.1795	0.129	-13.9973	0.1505	-8.89952
0.065	0.543978	0.0865	-10.9011	0.108	-13.6328	0.1295	-13.8151	0.151	-9.26335
0.0655	0.543978	0.087	-10.5371	0.1085	-13.9973	0.13	-13.9973	0.1515	-9.08143
0.066	0.543978	0.0875	-10.1731	0.109	-14.1795	0.1305	-14.544	0.152	-9.44528
0.0665	0.543978	0.088	-9.99114	0.1095	-14.544	0.131	-14.544	0.1525	-9.44528
0.067	0.725281	0.0885	-9.62722	0.11	-14.7262	0.1315	-14.7262	0.153	-9.44528
0.0675	0.725281	0.089	-9.44528	0.1105	-15.0908	0.132	-14.9085	0.1535	-9.62722
0.068	0.906573	0.0895	-9.80918	0.111	-15.0908	0.1325	-14.9085	0.154	-9.80918
0.0685	1.26912	0.09	-9.99114	0.1115	-15.2731	0.133	-15.0908	0.1545	-9.80918
0.069	1.99408	0.0905	-9.44528	0.112	-14.7262	0.1335	-15.0908	0.155	-9.80918
0.0695	3.26233	0.091	-9.08143	0.1125	-14.9085	0.134	-15.4554	0.1555	-9.99114
0.07	5.25415	0.0915	-8.89952	0.113	-14.544	0.1345	-15.6377	0.156	-9.99114
0.0705	6.70188	0.092	-9.44528	0.1135	-14.7262	0.135	-15.2731	0.1565	-9.62722
0.071	7.7872	0.0925	-9.62722	0.114	-15.2731	0.1355	-15.6377	0.157	-9.26335
0.0715	8.3297	0.093	-10.3551	0.1145	-15.0908	0.136	-15.6377	0.1575	-9.26335

GaugeJ2_2 Time msec	GaugeJ2_2 Stress MPa	GaugeJ2_2 Time msec	GaugeJ2_2 Stress MPa	GaugeJ2_3 Time msec	GaugeJ2_3 Stress MPa	GaugeJ2_3 Time msec	GaugeJ2_3 Stress MPa	GaugeJ2_3 Time msec	GaugeJ2_3 Stress MPa
0.158	-9.08143	0.1795	-2.90295	0.021	0	0.0425	0	0.064	0.906573
0.1585	-8.71762	0.18	-3.26603	0.0215	0	0.043	0	0.0645	1.26912
0.159	-7.99015	0.1805	-3.26603	0.022	0	0.0435	0	0.065	2.90003
0.1595	-7.62648	0.181	-3.62915	0.0225	0	0.044	0	0.0655	5.25415
0.16	-7.44466	0.1815	-3.62915	0.023	0	0.0445	0	0.066	8.3297
0.1605	-7.26286	0.182	-3.99231	0.0235	0	0.045	0	0.0665	10.6794
0.161	-6.89928	0.1825	-4.53715	0.024	0	0.0455	0	0.067	11.2213
0.1615	-6.71751	0.183	-4.71878	0.0245	0	0.046	0	0.0675	9.9566
0.162	-6.53575	0.1835	-4.53715	0.025	0	0.0465	0	0.068	7.42547
0.1625	-6.354	0.184	-4.71878	0.0255	0	0.047	0	0.0685	5.43516
0.163	-6.17227	0.1845	-5.08208	0.026	0	0.0475	0	0.069	4.34895
0.1635	-5.99054	0.185	-5.08208	0.0265	0	0.048	0	0.0695	3.80569
0.164	-5.99054	0.1855	-5.62712	0.027	0	0.0485	0	0.07	3.44346
0.1645	-5.80883	0.186	-5.99054	0.0275	0	0.049	0	0.0705	3.44346
0.165	-5.80883	0.1865	-6.17227	0.028	0	0.0495	0	0.071	2.71886
0.1655	-5.80883	0.187	-6.53575	0.0285	0	0.05	0	0.0715	1.26912
0.166	-5.80883	0.1875	-6.71751	0.029	0	0.0505	0	0.072	-0.181349
0.1665	-5.80883	0.188	-6.53575	0.0295	0	0.051	0	0.0725	-1.814
0.167	-5.80883	0.1885	-6.71751	0.03	0	0.0515	0	0.073	-3.62915
0.1675	-5.99054	0.189	-6.89928	0.0305	0	0.052	0	0.0735	-5.26375
0.168	-6.17227	0.1895	-7.26286	0.031	0	0.0525	0	0.074	-5.99054
0.1685	-5.80883	0.19	-7.44466	0.0315	0	0.053	0	0.0745	-6.354
0.169	-5.80883			0.032	0	0.0535	0	0.075	-6.89928
0.1695	-5.80883			0.0325	0	0.054	0	0.0755	-7.26286
0.17	-5.99054			0.033	0	0.0545	0	0.076	-7.26286
0.1705	-6.17227			0.0335	0	0.055	0	0.0765	-7.26286
0.171	-5.99054			0.034	0	0.0555	0	0.077	-6.71751
0.1715	-5.99054			0.0345	0	0.056	0	0.0775	-6.354
0.172	-6.53575			0.035	0	0.0565	0	0.078	-5.62712
0.1725	-6.354			0.0355	0	0.057	0	0.0785	-4.90043
0.173	-6.53575			0.036	0	0.0575	0	0.079	-3.99231
0.1735	-6.71751			0.0365	0	0.058	0	0.0795	-3.62915
0.174	-6.53575			0.037	0	0.0585	0	0.08	-2.17694
0.1745	-6.53575			0.0375	0	0.059	0	0.0805	-0.725464
0.175	-6.354			0.038	0	0.0595	0	0.081	0
0.1755	-6.354			0.0385	0	0.06	0	0.0815	0.362663
0.176	-6.17227			0.039	0	0.0605	0	0.082	0.906573
0.1765	-5.62712			0.0395	0	0.061	0.181337	0.0825	1.26912
0.177	-5.08208			0.04	0	0.0615	0.181337	0.083	1.45038
0.1775	-4.53715			0.0405	0	0.062	0.181337	0.0835	1.08785
0.178	-3.99231			0.041	0	0.0625	0.181337	0.084	0.725281
0.1785	-3.26603			0.0415	0	0.063	0.362663	0.0845	-0.362709
0.179	-3.08448			0.042	0	0.0635	0.543978	0.085	-1.814

GaugeJ2_3 Time msec	GaugeJ2_3 Stress MPa	GaugeJ2_3 Time msec	GaugeJ2_3 Stress MPa	GaugeJ2_3 Time msec	GaugeJ2_3 Stress MPa	GaugeJ2_3 Time msec	GaugeJ2_3 Stress MPa	GaugeJ2_3 Time msec	GaugeJ2_3 Stress MPa
0.0855	-3.08448	0.107	-14.7262	0.1285	-18.0089	0.15	-17.0967	0.1715	-13.4507
0.086	-4.17391	0.1075	-14.3617	0.129	-18.0089	0.1505	-17.644	0.172	-13.2685
0.0865	-5.99054	0.108	-14.544	0.1295	-18.3739	0.151	-17.644	0.1725	-13.0863
0.087	-7.44466	0.1085	-14.544	0.13	-18.7389	0.1515	-17.8265	0.173	-12.5399
0.0875	-8.35386	0.109	-14.544	0.1305	-18.9214	0.152	-18.0089	0.1735	-12.5399
0.088	-8.89952	0.1095	-14.544	0.131	-19.6516	0.1525	-18.0089	0.174	-12.1756
0.0885	-9.80918	0.11	-14.7262	0.1315	-19.4691	0.153	-18.0089	0.1745	-12.3577
0.089	-10.3551	0.1105	-15.0908	0.132	-19.8342	0.1535	-17.8265	0.175	-11.6293
0.0895	-10.9011	0.111	-15.2731	0.1325	-19.8342	0.154	-17.8265	0.1755	-11.4473
0.09	-11.4473	0.1115	-15.2731	0.133	-20.1994	0.1545	-17.644	0.176	-11.8114
0.0905	-12.1756	0.112	-16.0024	0.1335	-19.8342	0.155	-17.4616	0.1765	-11.2652
0.091	-12.1756	0.1125	-16.1848	0.134	-20.1994	0.1555	-17.2791	0.177	-11.4473
0.0915	-11.9935	0.113	-16.3671	0.1345	-20.1994	0.156	-17.0967	0.1775	-10.9011
0.092	-11.6293	0.1135	-16.5495	0.135	-19.8342	0.1565	-16.9143	0.178	-11.0832
0.0925	-12.1756	0.114	-16.9143	0.1355	-19.6516	0.157	-16.7319	0.1785	-10.7191
0.093	-12.3577	0.1145	-17.644	0.136	-19.104	0.1575	-17.4616	0.179	-10.7191
0.0935	-12.3577	0.115	-17.2791	0.1365	-19.4691	0.158	-16.5495	0.1795	-10.1731
0.094	-12.1756	0.1155	-17.2791	0.137	-19.104	0.1585	-16.5495	0.18	-9.99114
0.0945	-11.8114	0.116	-17.2791	0.1375	-19.2865	0.159	-16.3671	0.1805	-9.80918
0.095	-11.0832	0.1165	-17.2791	0.138	-18.9214	0.1595	-16.7319	0.181	-9.80918
0.0955	-10.9011	0.117	-17.4616	0.1385	-18.7389	0.16	-16.1848	0.1815	-9.80918
0.096	-11.4473	0.1175	-17.2791	0.139	-18.0089	0.1605	-15.8201	0.182	-9.80918
0.0965	-12.3577	0.118	-17.2791	0.1395	-17.2791	0.161	-16.5495	0.1825	-9.99114
0.097	-13.0863	0.1185	-17.2791	0.14	-16.9143	0.1615	-16.1848	0.183	-9.80918
0.0975	-13.4507	0.119	-16.9143	0.1405	-16.1848	0.162	-15.2731	0.1835	-9.80918
0.098	-13.8151	0.1195	-16.5495	0.141	-16.0024	0.1625	-15.6377	0.184	-10.3551
0.0985	-14.1795	0.12	-16.1848	0.1415	-15.8201	0.163	-14.9085	0.1845	-9.62722
0.099	-14.1795	0.1205	-16.0024	0.142	-15.8201	0.1635	-15.2731	0.185	-12.1756
0.0995	-14.3617	0.121	-15.6377	0.1425	-15.4554	0.164	-15.6377	0.1855	-9.44528
0.1	-14.9085	0.1215	-15.4554	0.143	-15.4554	0.1645	-15.4554	0.186	-9.26335
0.1005	-15.2731	0.122	-15.4554	0.1435	-15.8201	0.165	-15.4554	0.1865	-9.44528
0.101	-15.4554	0.1225	-15.4554	0.144	-15.8201	0.1655	-15.0908	0.187	-8.89952
0.1015	-15.8201	0.123	-15.4554	0.1445	-16.0024	0.166	-14.3617	0.1875	-9.08143
0.102	-16.0024	0.1235	-15.8201	0.145	-16.1848	0.1665	-15.0908	0.188	-8.53574
0.1025	-16.1848	0.124	-15.8201	0.1455	-16.1848	0.167	-15.0908	0.1885	-8.89952
0.103	-15.6377	0.1245	-15.4554	0.146	-16.1848	0.1675	-15.0908	0.189	-8.89952
0.1035	-15.4554	0.125	-16.0024	0.1465	-16.3671	0.168	-14.9085	0.1895	-8.71762
0.104	-15.0908	0.1255	-16.0024	0.147	-16.1848	0.1685	-14.7262	0.19	-8.71762
0.1045	-15.0908	0.126	-16.1848	0.1475	-16.3671	0.169	-14.544		
0.105	-14.7262	0.1265	-16.9143	0.148	-16.3671	0.1695	-14.3617		
0.1055	-15.0908	0.127	-16.9143	0.1485	-16.3671	0.17	-13.9973		
0.106	-14.7262	0.1275	-17.2791	0.149	-16.5495	0.1705	-13.6328		
0.1065	-14.9085	0.128	-17.6265	0.1495	-16.9143	0.171	-13.2685		

GaugeJ2_4 Time msec	GaugeJ2_4 Stress MPa	GaugeJ2_4 Time msec	GaugeJ2_4 Stress MPa	GaugeJ2_4 Time msec	GaugeJ2_4 Stress MPa	GaugeJ2_4 Time msec	GaugeJ2_4 Stress MPa	GaugeJ2_4 Time msec	GaugeJ2_4 Stress MPa
0.021	0.364086	0.0425	0.910128	0.064	0.182049	0.0855	1.09212	0.107	1.09212
0.0215	0.364086	0.043	0.910128	0.0645	0.182049	0.086	0.910128	0.1075	1.09212
0.022	0.546111	0.0435	0.910128	0.065	0	0.0865	1.09212	0.108	1.09212
0.0225	0.546111	0.044	0.910128	0.0655	0.182049	0.087	1.2741	0.1085	1.09212
0.023	0.364086	0.0445	0.910128	0.066	0.182049	0.0875	1.2741	0.109	0.910128
0.0235	0.546111	0.045	0.728125	0.0665	0.364086	0.088	1.2741	0.1095	0.910128
0.024	0.546111	0.0455	0.728125	0.067	0.546111	0.0885	1.2741	0.11	0.910128
0.0245	0.728125	0.046	0.728125	0.0675	0.364086	0.089	1.45607	0.1105	1.2741
0.025	0.546111	0.0465	0.910128	0.068	0.546111	0.0895	1.45607	0.111	0.910128
0.0255	0.728125	0.047	0.910128	0.0685	0.546111	0.09	1.63802	0.1115	1.09212
0.026	0.728125	0.0475	0.910128	0.069	0.546111	0.0905	1.63802	0.112	1.09212
0.0265	1.2741	0.048	0.910128	0.0695	0.728125	0.091	1.63802	0.1125	1.2741
0.027	0.728125	0.0485	0.728125	0.07	0.728125	0.0915	1.81997	0.113	1.09212
0.0275	0.728125	0.049	0.910128	0.0705	0.910128	0.092	1.45607	0.1135	1.09212
0.028	1.09212	0.0495	0.910128	0.071	0.728125	0.0925	1.63802	0.114	0.910128
0.0285	0.910128	0.05	0.910128	0.0715	0.910128	0.093	1.45607	0.1145	1.09212
0.029	0.910128	0.0505	0.910128	0.072	0.728125	0.0935	1.45607	0.115	1.09212
0.0295	0.910128	0.051	0.910128	0.0725	0.728125	0.094	1.45607	0.1155	1.09212
0.03	0.910128	0.0515	0.910128	0.073	0.728125	0.0945	1.63802	0.116	1.09212
0.0305	0.910128	0.052	0.910128	0.0735	0.728125	0.095	1.45607	0.1165	1.09212
0.031	0.728125	0.0525	0.910128	0.074	0.910128	0.0955	1.2741	0.117	1.09212
0.0315	0.910128	0.053	0.728125	0.0745	0.546111	0.096	1.2741	0.1175	0.910128
0.032	0.910128	0.0535	1.09212	0.075	0.728125	0.0965	0.910128	0.118	0.910128
0.0325	0.728125	0.054	0.910128	0.0755	0.728125	0.097	1.45607	0.1185	0.728125
0.033	0.728125	0.0545	0.910128	0.076	0.910128	0.0975	1.2741	0.119	0.546111
0.0335	0.728125	0.055	1.09212	0.0765	0.728125	0.098	1.63802	0.1195	0.546111
0.034	0.728125	0.0555	0.910128	0.077	0.728125	0.0985	1.45607	0.12	0.364086
0.0345	0.728125	0.056	1.09212	0.0775	0.910128	0.099	1.45607	0.1205	0.364086
0.035	0.910128	0.0565	0.910128	0.078	0.910128	0.0995	1.2741	0.121	0.364086
0.0355	0.910128	0.057	0.910128	0.0785	0.910128	0.1	1.45607	0.1215	0.182049
0.036	0.728125	0.0575	0.910128	0.079	0.910128	0.1005	1.63802	0.122	0
0.0365	0.546111	0.058	0.728125	0.0795	0.910128	0.101	1.45607	0.1225	0.182049
0.037	0.728125	0.0585	0.910128	0.08	1.09212	0.1015	1.45607	0.123	0
0.0375	0.546111	0.059	0.910128	0.0805	1.2741	0.102	1.45607	0.1235	0
0.038	0.910128	0.0595	0.728125	0.081	1.09212	0.1025	1.63802	0.124	0.364086
0.0385	0.546111	0.06	0.728125	0.0815	1.09212	0.103	1.63802	0.1245	0.182049
0.039	0.728125	0.0605	0.728125	0.082	1.09212	0.1035	1.45607	0.125	-0.18206
0.0395	0.728125	0.061	0.546111	0.0825	1.09212	0.104	1.45607	0.1255	-0.18206
0.04	0.910128	0.0615	0.546111	0.083	1.09212	0.1045	1.45607	0.126	0
0.0405	0.910128	0.062	0.728125	0.0835	1.09212	0.105	1.2741	0.1265	0
0.041	0.910128	0.0625	0.364086	0.084	1.09212	0.1055	1.2741	0.127	0
0.0415	0.910128	0.063	0.364086	0.0845	1.09212	0.106	1.2741	0.1275	-0.18206
0.042	0.910128	0.0635	0.182049	0.085	1.09212	0.1065	0.910128	0.128	-0.18206

Gauge32_4 Time msec	Gauge32_4 Stress MPa	Gauge32_4 Time msec	Gauge32_4 Stress MPa	Gauge32_4 Time msec	Gauge32_4 Stress MPa	Gauge32_4 Time msec	Gauge32_4 Stress MPa	Gauge32_5 Time msec	Gauge32_5 Stress MPa
0.1285	0	0.15	-6.37892	0.1715	-12.589	0.193	-11.6749	0.061	1.81997
0.129	0	0.1505	-6.74385	0.172	-12.4062	0.1935	-11.4922	0.0615	2.0019
0.1295	0	0.151	-7.29134	0.1725	-12.2234	0.194	-11.3094	0.062	1.81997
0.13	0	0.1515	-7.83893	0.173	-12.0405	0.1945	-11.3094	0.0625	1.63802
0.1305	0.182049	0.152	-8.38662	0.1735	-12.2234	0.195	-11.1266	0.063	1.81997
0.131	0.182049	0.1525	-8.75181	0.174	-11.8577	0.1955	-10.9439	0.0635	1.81997
0.1315	0.364086	0.153	-9.48232	0.1745	-11.8577	0.196	-11.1266	0.064	1.81997
0.132	0	0.1535	-10.0303	0.175	-11.4922	0.1965	-10.7612	0.0645	1.81997
0.1325	0	0.154	-10.7612	0.1755	-11.6749	0.197	-10.5784	0.065	1.81997
0.133	0.182049	0.1545	-11.3094	0.176	-11.4922	0.1975	-10.5784	0.0655	1.81997
0.1335	0	0.155	-11.6749	0.1765	-11.4922	0.198	-10.5784	0.066	1.81997
0.134	0.182049	0.1555	-12.0405	0.177	-11.4922	0.1985	-10.213	0.0665	2.0019
0.1345	0	0.156	-12.4062	0.1775	-11.3094	0.199	-10.213	0.067	2.0019
0.135	0.364086	0.1565	-12.9547	0.178	-11.3094	0.1995	-10.213	0.0675	2.18383
0.1355	0.182049	0.157	-13.3205	0.1785	-11.3094	0.2	-9.84764	0.068	2.18383
0.136	0.182049	0.1575	-13.8692	0.179	-10.9439	0.2005	-9.66498	0.0685	2.18383
0.1365	0.182049	0.158	-14.4181	0.1795	-11.1266	0.201	-9.84764	0.069	2.18383
0.137	0.364086	0.1585	-14.784	0.18	-10.9439	0.2015	-9.84764	0.0695	2.18383
0.1375	0.728125	0.159	-14.784	0.1805	-11.1266	0.202	-9.84764	0.07	2.18383
0.138	0.910128	0.1595	-14.967	0.181	-11.1266	0.2025	-9.84764	0.0705	2.18383
0.1385	1.2741	0.16	-14.967	0.1815	-10.9439	0.203	-9.66498	0.071	2.18383
0.139	2.18383	0.1605	-15.15	0.182	-10.9439	0.2035	-9.66498	0.0715	2.18383
0.1395	3.27512	0.161	-15.15	0.1825	-11.1266	0.204	-9.66498	0.072	2.18383
0.14	4.54778	0.1615	-15.15	0.183	-11.1266	0.2045	-9.29967	0.0725	2.0019
0.1405	6.00155	0.162	-15.15	0.1835	-11.1266	0.205	-9.29967	0.073	2.18383
0.141	7.0914	0.1625	-15.15	0.184	-10.9439	0.2055	-9.29967	0.0735	1.63802
0.1415	7.63617	0.163	-15.15	0.1845	-11.1266	0.206	-9.11704	0.074	2.36574
0.142	7.0914	0.1635	-14.967	0.185	-11.1266	0.2065	-9.29967	0.0745	2.0019
0.1425	6.36488	0.164	-14.784	0.1855	-11.3094	0.207	-9.11704	0.075	2.0019
0.143	5.45647	0.1645	-14.601	0.186	-11.3094	0.2075	-9.11704	0.0755	2.18383
0.1435	4.54778	0.165	-14.4181	0.1865	-11.1266	0.208	-9.11704	0.076	1.81997
0.144	3.27512	0.1655	-14.2351	0.187	-11.1266	0.2085	-9.11704	0.0765	2.18383
0.1445	2.18383	0.166	-14.0522	0.1875	-11.1266	0.209	-8.93442	0.077	1.63802
0.145	0.728125	0.1665	-14.0522	0.188	-11.3094	0.2095	-8.93442	0.0775	2.18383
0.1455	-0.364131	0.167	-13.6863	0.1885	-11.4922			0.078	2.18383
0.146	-1.27466	0.1675	-13.6863	0.189	-11.4922			0.0785	1.81997
0.1465	-2.36767	0.168	-13.3205	0.1895	-11.4922			0.079	2.0019
0.147	-3.09658	0.1685	-13.3205	0.19	-11.3094			0.0795	2.18383
0.1475	-3.82567	0.169	-13.3205	0.1905	-11.3094			0.08	2.36574
0.148	-4.73729	0.1695	-13.1376	0.191	-11.4922			0.0805	1.81997
0.1485	-5.10201	0.17	-12.9547	0.1915	-11.4922			0.081	2.0019
0.149	-5.46679	0.1705	-12.9547	0.192	-11.4922			0.0815	1.81997
0.1495	-5.83161	0.171	-12.589	0.1925	-11.4922			0.082	2.0019

Gauge32_5 Time msec	Gauge32_5 Stress MPa	Gauge32_5 Time msec	Gauge32_5 Stress MPa	Gauge32_5 Time msec	Gauge32_5 Stress MPa	Gauge32_5 Time msec	Gauge32_5 Stress MPa	Gauge32_5 Time msec	Gauge32_5 Stress MPa
0.0825	2.0019	0.104	3.09327	0.1255	1.09212	0.147	-0.728309	0.1685	-21.929
0.083	2.0019	0.1045	3.27512	0.126	0.910128	0.1475	-1.09253	0.169	-22.4794
0.0835	1.81997	0.105	2.9114	0.1265	0.728125	0.148	-1.27466	0.1695	-22.2959
0.084	1.81997	0.1055	3.27512	0.127	0.546111	0.1485	-1.4568	0.17	-22.6629
0.0845	2.0019	0.106	2.36574	0.1275	0.728125	0.149	-2.00329	0.1705	-22.4794
0.085	2.18383	0.1065	3.09327	0.128	0.910128	0.1495	-2.36767	0.171	-22.2959
0.0855	2.18383	0.107	3.27512	0.1285	0.728125	0.15	-3.09658	0.1715	-22.4794
0.086	2.0019	0.1075	3.27512	0.129	0.364086	0.1505	-3.09658	0.172	-22.6629
0.0865	2.0019	0.108	3.27512	0.1295	0.364086	0.151	-3.4611	0.1725	-22.6629
0.087	2.18383	0.1085	3.45696	0.13	0.546111	0.1515	-3.64338	0.173	-22.6629
0.0875	2.0019	0.109	3.45696	0.1305	0.182049	0.152	-3.82567	0.1735	-23.0298
0.088	2.18383	0.1095	3.27512	0.131	0.182049	0.1525	-3.82567	0.174	-22.8463
0.0885	2.54764	0.11	3.45696	0.1315	0	0.153	-4.19028	0.1745	-22.8463
0.089	2.54764	0.1105	3.45696	0.132	0.182049	0.1535	-4.55494	0.175	-22.2959
0.0895	2.54764	0.111	3.45696	0.1325	0.182049	0.154	-5.10201	0.1755	-22.4794
0.09	2.54764	0.1115	3.09327	0.133	0.182049	0.1545	-5.46679	0.176	-21.929
0.0905	2.72952	0.112	3.45696	0.1335	0.364086	0.155	-6.01403	0.1765	-21.7456
0.091	3.09327	0.1125	2.54764	0.134	0.364086	0.1555	-6.37892	0.177	-21.1954
0.0915	3.09327	0.113	2.72952	0.1345	0.364086	0.156	-6.92634	0.1775	-21.1954
0.092	3.09327	0.1135	2.72952	0.135	0.364086	0.1565	-7.83893	0.178	-21.3788
0.0925	3.09327	0.114	2.36574	0.1355	0.546111	0.157	-8.20405	0.1785	-21.1954
0.093	3.09327	0.1145	2.36574	0.136	0.728125	0.1575	-9.11704	0.179	-20.8287
0.0935	2.9114	0.115	2.18383	0.1365	0.728125	0.158	-10.0303	0.1795	-20.6453
0.094	3.09327	0.1155	2.18383	0.137	1.09212	0.1585	-10.9439	0.18	-20.6453
0.0945	3.27512	0.116	2.0019	0.1375	1.45607	0.159	-12.0405	0.1805	-20.6453
0.095	3.09327	0.1165	2.0019	0.138	2.36574	0.1595	-12.7719	0.181	-20.462
0.0955	2.9114	0.117	2.18383	0.1385	3.27512	0.16	-13.1376	0.1815	-20.0953
0.096	2.72952	0.1175	2.0019	0.139	4.54778	0.1605	-13.5034	0.182	-20.0953
0.0965	2.72952	0.118	1.63802	0.1395	5.63818	0.161	-14.2351	0.1825	-19.912
0.097	2.9114	0.1185	1.81997	0.14	6.54653	0.1615	-14.784	0.183	-20.0953
0.0975	2.9114	0.119	2.0019	0.1405	7.0914	0.162	-15.516	0.1835	-20.0953
0.098	2.9114	0.1195	1.81997	0.141	7.273	0.1625	-16.0652	0.184	-19.7287
0.0985	2.9114	0.12	1.63802	0.1415	6.54653	0.163	-16.7975	0.1845	-19.912
0.099	2.9114	0.1205	1.45607	0.142	4.91129	0.1635	-16.9806	0.185	-19.5454
0.0995	2.9114	0.121	1.45607	0.1425	3.09327	0.164	-17.3469	0.1855	-19.5454
0.1	2.9114	0.1215	1.45607	0.143	2.0019	0.1645	-18.0795	0.186	-19.5454
0.1005	2.9114	0.122	1.2741	0.1435	1.63802	0.165	-18.4459	0.1865	-19.3621
0.101	3.09327	0.1225	1.2741	0.144	1.81997	0.1655	-18.6292	0.187	-19.1789
0.1015	2.9114	0.123	1.2741	0.1445	1.63802	0.166	-19.5454	0.1875	-18.8124
0.102	3.09327	0.1235	0.910128	0.145	0.910128	0.1665	-19.7287	0.188	-18.8124
0.1025	3.09327	0.124	1.2741	0.1455	0.364086	0.167	-20.2786	0.1885	-18.6292
0.103	2.72952	0.1245	1.09212	0.146	0	0.1675	-21.012	0.189	-18.8124
0.1035	3.09327	0.125	0.910128	0.1465	-0.546214	0.168	-21.5622	0.1895	-18.2627

GaugeJ2_5 Time msec	GaugeJ2_5 Stress MPa	GaugeJ2_6 Time msec	GaugeJ2_6 Stress MPa	GaugeJ2_6 Time msec	GaugeJ2_6 Stress MPa	GaugeJ2_6 Time msec	GaugeJ2_6 Stress MPa	GaugeJ2_6 Time msec	GaugeJ2_6 Stress MPa
0.19	-18.0795	0.091	-0.363419	0.1125	0.908347	0.134	0.363373	0.1555	0
0.1905	-17.7132	0.0915	-0.181704	0.113	0.908347	0.1345	0.181692	0.156	0.181692
0.191	-17.53	0.092	-0.363419	0.1135	0.545043	0.135	0.181692	0.1565	0.363373
0.1915	-17.53	0.0925	-0.181704	0.114	0.908347	0.1355	0	0.157	0
0.192	-17.3469	0.093	-0.181704	0.1145	0.545043	0.136	0.181692	0.1575	-0.545146
0.1925	-17.3469	0.0935	0	0.115	0.726701	0.1365	0.181692	0.158	-0.181704
0.193	-17.1637	0.094	-0.181704	0.1155	0.908347	0.137	0.363373	0.1585	-0.545146
0.1935	-16.9806	0.0945	-0.545146	0.116	0.726701	0.1375	0	0.159	0.726701
0.194	-16.7975	0.095	0	0.1165	0.545043	0.138	0.363373	0.1595	-0.363419
0.1945	-16.4313	0.0955	-0.181704	0.117	0.545043	0.1385	0.181692	0.16	-0.181704
0.195	-16.2482	0.096	-0.181704	0.1175	0.545043	0.139	0	0.1605	0.181692
0.1955	-16.0652	0.0965	0	0.118	0.726701	0.1395	0	0.161	-0.363419
0.196	-16.0652	0.097	0	0.1185	0.545043	0.14	0.545043	0.1615	-0.181704
0.1965	-15.8821	0.0975	0	0.119	0.726701	0.1405	0	0.162	-1.601E-13
0.197	-15.6991	0.098	0	0.1195	0.726701	0.141	-0.181704	0.1625	-0.363419
0.1975	-15.516	0.0985	0	0.12	0.726701	0.1415	0	0.163	-0.363419
0.198	-15.333	0.099	0.181692	0.1205	0.545043	0.142	0	0.1635	0.363373
0.1985	-14.784	0.0995	0	0.121	0.545043	0.1425	-0.181704	0.164	-0.363419
0.199	-14.601	0.1	0	0.1215	0.545043	0.143	-0.181704	0.1645	-0.363419
0.1995	-14.2351	0.1005	0.181692	0.122	0.545043	0.1435	-0.181704	0.165	5.62714
0.2	-14.4181	0.101	0.363373	0.1225	0.363373	0.144	0	0.1655	-0.908633
		0.1015	0.545043	0.123	0.363373	0.1445	0	0.166	-0.545146
		0.102	0.363373	0.1235	0.545043	0.145	0	0.1665	-0.545146
		0.1025	0.545043	0.124	0.363373	0.1455	0	0.167	-0.726884
		0.103	0.726701	0.1245	0.363373	0.146	0	0.1675	-0.908633
		0.1035	0.726701	0.125	0.363373	0.1465	-0.545146	0.168	-0.726884
		0.104	0.908347	0.1255	0.363373	0.147	0.545043	0.1685	-0.726884
		0.1045	0.908347	0.126	0.363373	0.1475	0.181692	0.169	-0.726884
		0.105	0.908347	0.1265	0.181692	0.148	0.181692	0.1695	-0.726884
		0.1055	1.08998	0.127	0.363373	0.1485	0.363373	0.17	-0.726884
		0.106	0.908347	0.1275	0.181692	0.149	0.363373	0.1705	-0.545146
		0.1065	0.908347	0.128	0.545043	0.1495	0.363373	0.171	-0.726884
		0.107	1.08998	0.1285	0.363373	0.15	-0.363419	0.1715	-0.545146
		0.1075	0.908347	0.129	0.545043	0.1505	0.545043	0.172	-0.545146
		0.108	1.08998	0.1295	0.363373	0.151	0.545043	0.1725	-0.363419
		0.1085	1.08998	0.13	0.545043	0.1515	0.545043	0.173	-0.363419
		0.109	1.08998	0.1305	0.181692	0.152	0.363373	0.1735	-0.363419
		0.1095	1.27161	0.131	0.545043	0.1525	0.181692	0.174	-0.363419
		0.11	0.908347	0.1315	1.27161	0.153	0.363373	0.1745	-0.545146
		0.1105	0.908347	0.132	0.726701	0.1535	0.363373	0.175	-0.545146
		0.111	0.908347	0.1325	0.181692	0.154	0.545043	0.1755	-0.726884
		0.1115	1.08998	0.133	0.545043	0.1545	1.27161	0.176	-0.908633
		0.112	1.08998	0.1335	0.363373	0.155	0.181692	0.1765	-0.908633

GaugeJ2_6 Time msec	GaugeJ2_6 Stress MPa	GaugeJ2_6 Time msec	GaugeJ2_6 Stress MPa	GaugeJ2_6 Time msec	GaugeJ2_6 Stress MPa	GaugeJ2_6 Time msec	GaugeJ2_6 Stress MPa	GaugeJ2_6 Time msec	GaugeJ2_6 Stress MPa
0.177	-0.908633	0.1985	-0.908633	0.22	2.9057	0.2415	-10.0107	0.263	-1.81755
0.1775	-1.27217	0.199	-0.908633	0.2205	2.36111	0.242	-10.0107	0.2635	-1.63575
0.178	-1.45395	0.1995	-0.726884	0.221	1.81641	0.2425	-10.0107	0.264	-1.63575
0.1785	-1.63575	0.2	-0.908633	0.2215	1.08998	0.243	-9.82837	0.2645	-1.63575
0.179	-1.63575	0.2005	-1.09039	0.222	0.363373	0.2435	-9.64606	0.265	-1.81755
0.1795	-1.63575	0.201	-0.726884	0.2225	-0.726884	0.244	-9.82837	0.2655	-1.63575
0.18	-1.63575	0.2015	-0.726884	0.223	-1.09039	0.2445	-9.82837	0.266	-1.63575
0.1805	-1.81755	0.202	-0.545146	0.2235	-2.36304	0.245	-9.82837	0.2665	-1.63575
0.181	-1.27217	0.2025	-0.545146	0.224	-3.09052	0.2455	-11.2873	0.267	-1.63575
0.1815	-1.45395	0.203	-0.363419	0.2245	-4.18208	0.246	-6.54854	0.2675	-1.63575
0.182	-1.45395	0.2035	0	0.225	-4.91002	0.2465	-1.09039	0.268	-1.63575
0.1825	-1.09039	0.204	0.181692	0.2255	-6.00226	0.247	-2.54489		
0.183	-0.908633	0.2045	0.363373	0.226	-6.36644	0.2475	-2.72676		
0.1835	-0.726884	0.205	0.545043	0.2265	-6.73066	0.248	0		
0.184	-0.363419	0.2055	1.08998	0.227	-7.09492	0.2485	-7.64141		
0.1845	-0.181704	0.206	0.908347	0.2275	-6.54854	0.249	-6.73066		
0.185	0.181692	0.2065	1.45322	0.228	-7.09492	0.2495	-5.63814		
0.1855	0.363373	0.207	1.27161	0.2285	-7.45923	0.25	-4.72801		
0.186	0.545043	0.2075	1.45322	0.229	-7.64141	0.2505	-4.18208		
0.1865	0.363373	0.208	3.08721	0.2295	-7.82359	0.251	-3.81818		
0.187	0.363373	0.2085	1.27161	0.23	-7.82359	0.2515	-3.63625		
0.1875	0.363373	0.209	1.08998	0.2305	-8.00579	0.252	-3.63625		
0.188	0.363373	0.2095	1.81641	0.231	-7.82359	0.2525	-3.09052		
0.1885	0.363373	0.21	1.81641	0.2315	-8.37021	0.253	-3.09052		
0.189	0.545043	0.2105	2.36111	0.232	-6.91278	0.2535	-3.09052		
0.1895	0.363373	0.211	0.363373	0.2325	-8.55244	0.254	-2.90863		
0.19	0.363373	0.2115	0.181692	0.233	-8.37021	0.2545	-2.1812		
0.1905	0.363373	0.212	0.363373	0.2335	-8.73468	0.255	-2.54489		
0.191	0.181692	0.2125	0.363373	0.234	-8.73468	0.2555	-2.1812		
0.1915	0.181692	0.213	1.08998	0.2345	-8.73468	0.256	-2.36304		
0.192	-0.181704	0.2135	5.98981	0.235	-8.91694	0.2565	-1.99937		
0.1925	-0.363419	0.214	1.27161	0.2355	-9.0992	0.257	-2.1812		
0.193	-0.363419	0.2145	1.45322	0.236	-8.91694	0.2575	-1.99937		
0.1935	-0.545146	0.215	1.63482	0.2365	-9.28148	0.258	-2.1812		
0.194	-0.545146	0.2155	1.81641	0.237	-9.28148	0.2585	-1.81755		
0.1945	-0.545146	0.216	2.17955	0.2375	-9.46376	0.259	-1.81755		
0.195	-0.545146	0.2165	2.72418	0.238	-9.28148	0.2595	-1.99937		
0.1955	-0.363419	0.217	2.72418	0.2385	-9.28148	0.26	-1.99937		
0.196	-0.363419	0.2175	3.08721	0.239	-9.28148	0.2605	-1.81755		
0.1965	-0.363419	0.218	3.26871	0.2395	-9.64606	0.261	-1.99937		
0.197	-0.363419	0.2185	3.81314	0.24	-9.46376	0.2615	-1.81755		
0.1975	-0.726884	0.219	3.81314	0.2405	-10.0107	0.262	-1.81755		
0.198	-0.545146	0.2195	3.63167	0.241	-9.82837	0.2625	-1.63575		

Gauge33_1	Gauge33_1	Gauge33_1	Gauge33_1	Gauge33_1	Gauge33_1	Gauge33_2	Gauge33_2	Gauge33_2	Gauge33_2
Time	Stress	Time	Stress	Time	Stress	Time	Stress	Time	Stress
msec	MPa	msec	MPa	msec	MPa	msec	MPa	msec	MPa
-0.014	0	0.0075	-17.2271	0.029	-17.2271	0.0135	0	0.035	0
-0.0135	8.57834	0.008	-69.4713	0.0295	-17.2271	0.014	0.170671	0.0355	-0.68279
-0.013	0	0.0085	-34.548	0.03	-17.2271	0.0145	0.34133	0.036	2.72944
-0.0125	0	0.009	-8.6018	0.0305	-34.548	0.015	0.511979	0.0365	1.36506
-0.012	0	0.0095	-113.653	0.031	-34.548	0.0155	0.34133	0.037	-0.853514
-0.0115	0	0.01	-17.2271	0.0315	-34.548	0.016	0.34133	0.0375	-0.68279
-0.011	0	0.0105	17.1332	0.032	-43.2436	0.0165	0.34133	0.038	0.34133
-0.0105	0	0.011	25.6646	0.0325	-43.2436	0.017	0.34133	0.0385	0.853245
-0.01	0	0.0115	-34.548	0.033	-25.8758	0.0175	0.170671	0.039	0.511979
-0.0095	0	0.012	0	0.0335	-34.548	0.018	0	0.0395	0.170671
-0.009	0	0.0125	-25.8758	0.034	-34.548	0.0185	0.170671	0.04	0.170671
-0.0085	0	0.013	-34.548	0.0345	-17.2271	0.019	0.853245	0.0405	0.34133
-0.008	0	0.0135	-43.2436	0.035	67.9698	0.0195	1.5038E-13	0.041	0
-0.0075	0	0.014	-60.7053	0.0355	-8.6018	0.02	-0.68279	0.0415	0.170671
-0.007	0	0.0145	-60.7053	0.036	17.1332	0.0205	-0.512076	0.042	0
-0.0065	8.57834	0.015	-87.0738	0.0365	17.1332	0.021	0.34133	0.0425	0
-0.006	0	0.0155	-78.2608	0.037	0	0.0215	1.36506	0.043	-0.341373
-0.0055	0	0.016	-51.9627	0.0375	8.57834	0.022	1.02386	0.0435	-1.53652
-0.005	0	0.0165	-25.8758	0.038	0	0.0225	-1.36575	0.044	1.19447
-0.0045	0	0.017	-43.2436	0.0385	17.1332	0.023	0	0.0445	2.89994
-0.004	0	0.0175	-34.548	0.039	25.6646	0.0235	0.853245	0.045	1.19447
-0.0035	0	0.018	-17.2271	0.0395	25.6646	0.024	0.682618	0.0455	-0.341373
-0.003	0	0.0185	0	0.04	17.1332	0.0245	1.53565	0.046	-0.68279
-0.0025	0	0.019	17.1332	0.0405	25.6646	0.025	1.70622	0.0465	0.170671
-0.002	0	0.0195	25.6646	0.041	25.6646	0.0255	-1.7073	0.047	0.170671
-0.0015	-8.6018	0.02	42.6571	0.0415	25.6646	0.026	-1.87808	0.0475	0.511979
-0.001	0	0.0205	51.1181	0.042	42.6571	0.0265	-0.512076	0.048	0.170671
-0.0005	0	0.021	34.1726	0.0425	42.6571	0.027	0.853245	0.0485	-0.170681
0	0	0.0215	42.6571	0.043	76.3605	0.0275	1.36506	0.049	0.511979
0.0005	17.1332	0.022	59.5557	0.0435	109.688	0.028	0.34133	0.0495	0.682618
0.001	-8.6018	0.0225	51.1181	0.044	109.688	0.0285	-0.341373	0.05	1.19447
0.0015	215.412	0.023	51.1181	0.0445	93.0714	0.029	-0.512076	0.0505	0.853245
0.002	167.109	0.0235	34.1726	0.045	59.5557	0.0295	0.170671	0.051	0.511979
0.0025	34.1726	0.024	17.1332	0.0455	42.6571	0.03	0.853245	0.0515	0.34133
0.003	-17.2271	0.0245	-25.8758	0.046	25.6646	0.0305	0.682618	0.052	0.682618
0.0035	-95.9102	0.025	-17.2271	0.0465	25.6646	0.031	0.34133	0.0525	0.682618
0.004	-69.4713	0.0255	-17.2271	0.047	8.57834	0.0315	0.170671	0.053	0.34133
0.0045	0	0.026	-8.6018	0.0475	-17.2271	0.032	0.34133	0.0535	0.682618
0.005	34.1726	0.0265	-8.6018	0.048	-25.8758	0.0325	0.34133	0.054	0.34133
0.0055	-34.548	0.027	-17.2271	0.0485	-34.548	0.033	0.34133	0.0545	0.511979
0.006	-60.7053	0.0275	-8.6018			0.0335	0.511979	0.055	0.170671
0.0065	0	0.028	-17.2271			0.034	0.34133	0.0555	0.34133
0.007	0	0.0285	-17.2271			0.0345	0.34133	0.056	1.5038E-13

Gauge33_2	Gauge33_2	Gauge33_2	Gauge33_2	Gauge33_3	Gauge33_3	Gauge33_3	Gauge33_3	Gauge33_3	Gauge33_3
Time	Stress	Time	Stress	Time	Stress	Time	Stress	Time	Stress
msec	MPa	msec	MPa	msec	MPa	msec	MPa	msec	MPa
0.0565	0.170671	0.078	-3.75747	0.048	0	0.0695	-3.63332	0.091	-5.5384
0.057	0.170671	0.0785	-3.75747	0.0485	0	0.07	-4.32592	0.0915	-5.71165
0.0575	0	0.079	-4.27026	0.049	0.172895	0.0705	-5.36515	0.092	-6.57809
0.058	0	0.0795	-4.95412	0.0495	0.34578	0.071	-5.5384	0.0925	-6.23148
0.0585	-0.170681	0.08	-4.95412	0.05	0	0.0715	-5.5384	0.093	-6.57809
0.059	0	0.0805	-4.95412	0.0505	0	0.072	-5.88492	0.0935	-7.09808
0.0595	-0.170681	0.081	-4.95412	0.051	0	0.0725	-6.05819	0.094	-7.44479
0.06	-0.170681	0.0815	-5.29612	0.0515	0	0.073	-5.5384	0.0945	-7.79155
0.0605	-0.170681	0.082	-5.63816	0.052	0	0.0735	-5.5384	0.095	-8.4852
0.061	0	0.0825	-6.49344	0.0525	-0.172906	0.074	-5.19192	0.0955	-8.65864
0.0615	0			0.053	-0.172906	0.0745	-5.36515	0.096	-8.83209
0.062	0.170671			0.0535	-0.172906	0.075	-4.84549	0.0965	-8.65864
0.0625	0.34133			0.054	-0.172906	0.0755	-4.4991	0.097	-8.65864
0.063	0.682618			0.0545	-0.172906	0.076	-4.15275	0.0975	-8.65864
0.0635	1.70622			0.055	-0.172906	0.0765	-3.63332	0.098	-8.83209
0.064	3.07043			0.0555	-0.172906	0.077	-2.7678	0.0985	-9.35251
0.0645	4.94508			0.056	-0.172906	0.0775	-1.72955	0.099	-9.69951
0.065	6.98868			0.0565	-0.345823	0.078	-1.21057	0.0995	-9.69951
0.0655	8.18006			0.057	-0.345823	0.0785	-1.21057	0.1	-9.69951
0.066	7.15891			0.0575	-0.172906	0.079	-1.21057	0.1005	-10.2201
0.0665	5.28579			0.058	-0.345823	0.0795	-0.69169	0.101	-9.69951
0.067	2.89994			0.0585	-0.172906	0.08	-0.69169	0.1015	-9.87302
0.0675	1.87678			0.059	-0.345823	0.0805	-0.518751	0.102	-9.87302
0.068	1.02386			0.0595	-1.523E-13	0.081	-0.345823	0.1025	-9.69951
0.0685	0.34133			0.06	0.172895	0.0815	-0.172906	0.103	-9.526
0.069	0.34133			0.0605	0.34578	0.082	-0.172906	0.1035	-9.17903
0.0695	0.511979			0.061	0.864367	0.0825	-0.86464	0.104	-9.00555
0.07	0.682618			0.0615	1.72846	0.083	-1.55655	0.1045	-8.83209
0.0705	0			0.062	3.28315	0.0835	-1.72955	0.105	-8.65864
0.071	-1.19499			0.0625	7.42467	0.084	-1.55655	0.1055	-7.96495
0.0715	-2.21969			0.063	12.0764	0.0845	-1.38355	0.106	-7.79155
0.072	-2.73219			0.0635	13.7972	0.085	-1.38355	0.1065	-7.27143
0.0725	-3.58656			0.064	10.5267	0.0855	-1.72955	0.107	-6.92474
0.073	-4.27026			0.0645	7.42467	0.086	-2.7678	0.1075	-6.57809
0.0735	-4.61217			0.065	5.35469	0.0865	-3.11398	0.108	-6.40478
0.074	-4.95412			0.0655	3.97384	0.087	-3.63332	0.1085	-6.75141
0.0745	-5.12511			0.066	3.11045	0.0875	-3.63332	0.109	-6.40478
0.075	-4.95412			0.0665	1.90125	0.088	-3.46019	0.1095	-6.75141
0.0755	-5.29612			0.067	0.864367	0.0885	-3.28708	0.11	-6.05819
0.076	-5.12511			0.0675	-0.518751	0.089	-3.46019	0.1105	-6.05819
0.0765	-5.46713			0.068	-1.21057	0.0895	-3.63332	0.111	-6.40478
0.077	-5.12511			0.0685	-1.90257	0.09	-3.9796	0.1115	-6.92474
0.0775	-4.27026			0.069	-2.7678	0.0905	-4.84549	0.112	-6.75141

Gauge33_3	Gauge33_3	Gauge33_3	Gauge33_3	Gauge33_3	Gauge33_3	Gauge33_3	Gauge33_3	Gauge33_3	Gauge33_3
Time	Stress	Time	Stress	Time	Stress	Time	Stress	Time	Stress
msec	MPa	msec	MPa	msec	MPa	msec	MPa	msec	MPa
0.1125	-6.75141	0.134	-1.55655	0.1555	3.28315	0.177	1.21004	0.1985	-1.55655
0.113	-6.92474	0.1345	-0.172906	0.156	2.24679	0.1775	0.691516	0.199	-2.24863
0.1135	-7.09808	0.135	-0.518751	0.1565	1.55567	0.178	0.172895	0.1995	-2.24863
0.114	-7.27143	0.1355	-0.86464	0.157	0.691516	0.1785	0	0.2	-2.24863
0.1145	-7.27143	0.136	-0.69169	0.1575	0.172895	0.179	-0.172906	0.2005	-2.07559
0.115	-7.96495	0.1365	-0.518751	0.158	-0.69169	0.1795	-0.518751	0.201	-2.24863
0.1155	-7.61817	0.137	-0.345823	0.1585	-1.21057	0.18	-0.86464	0.2015	-2.07559
0.116	-7.44479	0.1375	0.172895	0.159	-1.72955	0.1805	-1.0376	0.202	-1.72955
0.1165	-7.09808	0.138	0.34578	0.1595	-2.07559	0.181	-1.21057	0.2025	-2.24863
0.117	-6.92474	0.1385	0.518653	0.16	-2.42168	0.1815	-1.55655	0.203	-1.55655
0.1175	-6.75141	0.139	0.518653	0.1605	-2.7678	0.182	-1.90257	0.2035	-0.86464
0.118	-6.23148	0.1395	0.518653	0.161	-3.11398	0.1825	-1.72955	0.204	-0.86464
0.1185	-6.05819	0.14	0.691516	0.1615	-2.42168	0.183	-1.72955	0.2045	-0.518751
0.119	-5.0187	0.1405	0.691516	0.162	-2.7678	0.1835	-1.55655	0.205	-0.518751
0.1195	-5.0187	0.141	0.691516	0.1625	-2.7678	0.184	-1.38355	0.2055	-0.345823
0.12	-4.67229	0.1415	1.55567	0.163	-2.42168	0.1845	-1.38355	0.206	-0.172906
0.1205	-4.15275	0.142	0.34578	0.1635	-2.42168	0.185	-1.0376	0.2065	0.34578
0.121	-3.63332	0.1425	0.864367	0.164	-2.24863	0.1855	-0.86464	0.207	0.172895
0.1215	-3.63332	0.143	0.691516	0.1645	-1.72955	0.186	-0.86464	0.2075	0
0.122	-3.46019	0.1435	1.03721	0.165	-1.90257	0.1865	-0.69169	0.208	-0.172906
0.1225	-4.15275	0.144	1.21004	0.1655	-1.55655	0.187	-0.518751	0.2085	0
0.123	-3.11398	0.1445	1.03721	0.166	-1.21057	0.1875	-0.345823	0.209	-0.172906
0.1235	-2.94089	0.145	1.21004	0.1665	-0.345823	0.188	-0.345823	0.2095	0
0.124	-2.42168	0.1455	1.21004	0.167	-1.21057	0.1885	-0.172906	0.21	0
0.1245	-2.07559	0.146	1.38286	0.1675	-1.21057	0.189	0.34578	0.2105	-0.69169
0.125	-3.11398	0.1465	1.55567	0.168	-1.0376	0.1895	0.172895	0.211	-0.518751
0.1255	-2.07559	0.147	1.21004	0.1685	-0.69169	0.19	0.34578	0.2115	-0.518751
0.126	-1.38355	0.1475	1.55567	0.169	-0.518751	0.1905	0.34578	0.212	-0.69169
0.1265	-1.55655	0.148	1.90125	0.1695	-1.72955	0.191	0	0.2125	-0.86464
0.127	-1.38355	0.1485	2.76502	0.17	0.172895	0.1915	0	0.213	-1.21057
0.1275	-1.21057	0.149	4.14648	0.1705	2.07402	0.192	-0.69169	0.2135	-1.0376
0.128	-1.21057	0.1495	4.83695	0.171	0.864367	0.1925	0.34578	0.214	-1.0376
0.1285	-1.21057	0.15	5.87233	0.1715	1.21004	0.193	-0.172906	0.2145	-0.86464
0.129	-1.21057	0.1505	6.21737	0.172	1.38286	0.1935	-0.345823	0.215	-1.21057
0.1295	-1.21057	0.151	6.04486	0.1725	1.55567	0.194	-0.86464	0.2155	-0.86464
0.13	-0.86464	0.1515	6.04486	0.173	1.55567	0.1945	-0.518751	0.216	-0.86464
0.1305	-1.0376	0.152	5.87233	0.1735	1.55567	0.195	-1.0376	0.2165	-1.21057
0.131	-1.55655	0.1525	5.52725	0.174	1.55567	0.1955	-0.345823	0.217	-1.21057
0.1315	-1.55655	0.153	5.6998	0.1745	1.55567	0.196	-0.345823	0.2175	-1.21057
0.132	-2.07559	0.1535	5.52725	0.175	1.21004	0.1965	-1.21057	0.218	-1.0376
0.1325	-2.24863	0.154	5.18212	0.1755	1.38286	0.197	-1.21057	0.2185	-1.0376
0.133	-1.21057	0.1545	4.66435	0.176	1.38286	0.1975	-1.38355	0.219	-0.86464
0.1335	-1.38355	0.155	4.31912	0.1765	1.21004	0.198	-2.07559	0.2195	-0.86464

Gauge33_3	Gauge33_3	Gauge33_3	Gauge33_3	Gauge33_4	Gauge33_4	Gauge33_4	Gauge33_4	Gauge33_4	Gauge33_4
Time	Stress	Time	Stress	Time	Stress	Time	Stress	Time	Stress
msec	MPa	msec	MPa	msec	MPa	msec	MPa	msec	MPa
0.22	-0.86464	0.2415	-0.86464	0.0205	0	0.042	0.174193	0.0635	-0.174204
0.2205	-0.69169	0.242	-1.21057	0.021	0.174193	0.0425	0	0.064	-0.348418
0.221	-0.518751			0.0215	0.174193	0.043	0	0.0645	-0.348418
0.2215	-0.518751			0.022	0.174193	0.0435	0.174193	0.065	-0.348418
0.222	-0.345823			0.0225	0	0.044	0.174193	0.0655	-0.348418
0.2225	-0.345823			0.023	0	0.0445	0.174193	0.066	-0.348418
0.223	-0.172906			0.0235	0	0.045	0.174193	0.0665	-0.522644
0.2235	-0.345823			0.024	0	0.0455	0.174193	0.067	-0.348418
0.224	-0.518751			0.0245	0.174193	0.046	0.174193	0.0675	-0.348418
0.2245	-0.518751			0.025	0.174193	0.0465	0.174193	0.068	-0.348418
0.225	-0.518751			0.0255	0	0.047	0.174193	0.0685	-0.348418
0.2255	-0.518751			0.026	0	0.0475	0.174193	0.069	-0.348418
0.226	-0.345823			0.0265	0.174193	0.048	0.174193	0.0695	-0.348418
0.2265	-0.345823			0.027	0	0.0485	0.348375	0.07	-0.348418
0.227	-0.172906			0.0275	-0.174204	0.049	0.348375	0.0705	-0.348418
0.2275	-0.172906			0.028	-0.174204	0.0495	-0.174204	0.071	-0.348418
0.228	-0.345823			0.0285	0	0.05	0	0.0715	-0.522644
0.2285	-0.172906			0.029	0	0.0505	0.174193	0.072	-0.348418
0.229	-0.172906			0.0295	0	0.051	0.174193	0.0725	-0.522644
0.2295	0.34578			0.03	0	0.0515	0.174193	0.073	-0.348418
0.23	0.34578			0.0305	0	0.052	0.174193	0.0735	-0.348418
0.2305	0.518653			0.031	-0.174204	0.0525	0.174193	0.074	-0.348418
0.231	0.864367			0.0315	0.174193	0.053	0	0.0745	-0.348418
0.2315	0.864367			0.032	1.5348E-13	0.0535	0.174193	0.075	-0.348418
0.232	1.21004			0.0325	-0.174204	0.054	0.174193	0.0755	-0.522644
0.2325	1.72846			0.033	0	0.0545	0.174193	0.076	-0.348418
0.233	1.55567			0.0335	0	0.055	0	0.0765	-0.348418
0.2335	1.38286			0.034	0	0.0555	0.174193	0.077	-0.348418
0.234	1.38286			0.0345	0	0.056	0.174193	0.0775	-0.522644
0.2345	1.38286			0.035	0	0.0565	0.348375	0.078	-0.348418
0.235	1.55567			0.0355	0	0.057	0.348375	0.0785	-0.348418
0.2355	1.38286			0.036	0.174193	0.0575	0.174193	0.079	-0.348418
0.236	1.38286			0.0365	0	0.058	0	0.0795	-0.174204
0.2365	1.03721			0.037	0	0.0585	0.348375	0.08	-0.522644
0.237	0.864367			0.0375	0	0.059	0.174193	0.0805	-0.348418
0.2375	0.518653			0.038	0	0.0595	1.5348E-13	0.081	-0.522644
0.238	0.34578			0.0385	0	0.06	0	0.0815	-0.522644
0.2385	0			0.039	0	0.0605	0.174193	0.082	-0.871128
0.239	0.518653			0.0395	0	0.061	0	0.0825	-0.522644
0.2395	0			0.04	0	0.0615	0	0.083	-0.696881
0.24	-0.69169			0.0405	0	0.062	0	0.0835	-0.871128
0.2405	-0.345823			0.041	0	0.0625	0	0.084	-0.871128
0.241	-0.518751			0.0415	0	0.063	-0.174204	0.0845	-1.04539

Gauge33_4 Time msec	Gauge33_4 Stress MPa	Gauge33_4 Time msec	Gauge33_4 Stress MPa	Gauge33_4 Time msec	Gauge33_4 Stress MPa	Gauge33_4 Time msec	Gauge33_4 Stress MPa	Gauge33_4 Time msec	Gauge33_4 Stress MPa
0.085	-1.04539	0.1065	-0.696881	0.128	0	0.1495	3.30779	0.171	-4.88185
0.0855	-1.04539	0.107	0	0.1285	-0.174204	0.15	2.78577	0.1715	-6.80207
0.086	-1.04539	0.1075	-0.696881	0.129	0.174193	0.1505	2.26365	0.172	-6.62745
0.0865	-0.871128	0.108	-0.348418	0.1295	0	0.151	1.56734	0.1725	-6.80207
0.087	-1.04539	0.1085	-0.348418	0.13	0	0.1515	1.21912	0.173	-6.62745
0.0875	-0.871128	0.109	-0.348418	0.1305	0	0.152	0.348375	0.1735	-6.80207
0.088	-0.871128	0.1095	-0.522644	0.131	0	0.1525	-0.174204	0.174	-5.92908
0.0885	-0.696881	0.11	-0.522644	0.1315	0	0.153	-1.04539	0.1745	-5.75451
0.089	-0.522644	0.1105	-0.174204	0.132	0	0.1535	-1.56823	0.175	-5.23088
0.0895	-0.522644	0.111	-0.348418	0.1325	-0.174204	0.154	-2.2655	0.1755	-5.05636
0.09	-0.522644	0.1115	-0.174204	0.133	-1.535E-13	0.1545	-2.78858	0.176	-4.88185
0.0905	-0.522644	0.112	-0.174204	0.1335	0	0.155	-3.31175	0.1765	-4.18392
0.091	-0.348418	0.1125	-0.348418	0.134	-0.348418	0.1555	-3.83502	0.177	-4.35838
0.0915	-0.174204	0.113	-0.174204	0.1345	-0.348418	0.156	-4.35838	0.1775	-4.18392
0.092	-0.174204	0.1135	0	0.135	-0.348418	0.1565	-4.18392	0.178	-4.18392
0.0925	-0.348418	0.114	-0.522644	0.1355	-0.696881	0.157	-4.35838	0.1785	-0.696881
0.093	0	0.1145	-0.174204	0.136	-0.696881	0.1575	-4.53286	0.179	-3.13735
0.0935	-0.174204	0.115	-0.174204	0.1365	-0.696881	0.158	-4.35838	0.1795	-3.13735
0.094	-0.174204	0.1155	-0.174204	0.137	-1.04539	0.1585	-4.53286	0.18	-2.96296
0.0945	0	0.116	-0.174204	0.1375	-0.871128	0.159	-4.70735	0.1805	-2.96296
0.095	-0.174204	0.1165	-0.348418	0.138	-1.04539	0.1595	-5.05636	0.181	-2.61421
0.0955	0	0.117	-0.348418	0.1385	-1.21966	0.16	-5.05636	0.1815	-2.43985
0.096	0	0.1175	-0.174204	0.139	-1.21966	0.1605	-5.23088	0.182	-2.43985
0.0965	-0.174204	0.118	-0.174204	0.1395	-1.21966	0.161	-5.05636	0.1825	-2.43985
0.097	-0.348418	0.1185	-0.174204	0.14	-1.04539	0.1615	-4.88185	0.183	-2.78858
0.0975	-0.174204	0.119	-0.174204	0.1405	-1.21966	0.162	-5.23088	0.1835	-2.61421
0.098	-0.174204	0.1195	-0.174204	0.141	-1.21966	0.1625	-5.23088	0.184	-2.61421
0.0985	-0.174204	0.12	-0.348418	0.1415	-1.39394	0.163	-5.40542	0.1845	-2.61421
0.099	-0.522644	0.1205	-0.174204	0.142	-1.39394	0.1635	-5.75451	0.185	-2.61421
0.0995	-0.522644	0.121	-0.348418	0.1425	-1.39394	0.164	-6.10366	0.1855	-2.78858
0.1	-0.696881	0.1215	-0.348418	0.143	-1.04539	0.1645	-6.27824	0.186	-2.61421
0.1005	-0.696881	0.122	-0.522644	0.1435	-1.21966	0.165	-6.10366	0.1865	-2.61421
0.101	-0.348418	0.1225	-0.522644	0.144	-1.04539	0.1655	-6.45284	0.187	-2.61421
0.1015	-0.696881	0.123	-0.522644	0.1445	-0.871128	0.166	-5.75451	0.1875	-2.78858
0.102	-0.696881	0.1235	-0.522644	0.145	-0.696881	0.1665	-5.57996	0.188	-2.78858
0.1025	-0.522644	0.124	-1.91684	0.1455	-0.174204	0.167	-6.27824	0.1885	-2.96296
0.103	-0.696881	0.1245	-1.74253	0.146	0.348375	0.1675	-6.10366	0.189	-2.96296
0.1035	-0.696881	0.125	0	0.1465	1.39324	0.168	-6.10366	0.1895	-2.78858
0.104	-0.871128	0.1255	0	0.147	2.4377	0.1685	-6.10366	0.19	-1.91684
0.1045	-0.696881	0.126	-0.522644	0.1475	3.48177	0.169	-6.27824	0.1905	-2.78858
0.105	-0.522644	0.1265	-0.522644	0.148	4.52545	0.1695	-6.62745	0.191	-2.78858
0.1055	-0.696881	0.127	-0.348418	0.1485	4.69936	0.17	-6.45284	0.1915	-2.09117
0.106	-0.348418	0.1275	0	0.149	4.1776	0.1705	-6.45284	0.192	-1.91684

Gauge33_4 Time msec	Gauge33_4 Stress MPa	Gauge33_4 Time msec	Gauge33_4 Stress MPa	Gauge33_5 Time msec	Gauge33_5 Stress MPa	Gauge33_5 Time msec	Gauge33_5 Stress MPa	Gauge33_5 Time msec	Gauge33_5 Stress MPa
0.1925	-1.74253	0.214	-3.31175	0.112	0.172895	0.1335	0	0.155	-8.83209
0.193	-1.91684	0.2145	-3.31175	0.1125	-1.72955	0.134	0.34578	0.1555	-9.00555
0.1935	-0.871128	0.215	-4.18392	0.113	0.34578	0.1345	0.518653	0.156	-9.35251
0.194	-1.39394	0.2155	-4.00946	0.1135	0.172895	0.135	-1.0376	0.1565	-9.17903
0.1945	-1.04539	0.216	-4.35838	0.114	-0.345823	0.1355	0.518653	0.157	-9.526
0.195	0	0.2165	-4.35838	0.1145	0.34578	0.136	0	0.1575	-9.35251
0.1955	-0.348418	0.217	-3.66058	0.115	0.172895	0.1365	0.34578	0.158	-9.526
0.196	-0.348418	0.2175	-4.00946	0.1155	0.34578	0.137	0.34578	0.1585	-9.69951
0.1965	-0.174204	0.218	-3.83502	0.116	0.172895	0.1375	0.34578	0.159	-10.2201
0.197	0	0.2185	-5.05636	0.1165	-0.172906	0.138	0.691516	0.1595	-10.2201
0.1975	0.696705	0.219	-6.80207	0.117	0.518653	0.1385	0.691516	0.16	-10.2201
0.198	1.91552	0.2195	-4.18392	0.1175	0.34578	0.139	0.691516	0.1605	-10.3936
0.1985	1.04499	0.22	-4.53286	0.118	0.172895	0.1395	1.03721	0.161	-10.7408
0.199	0.870854	0.2205	-4.53286	0.1185	0.34578	0.14	1.38286	0.1615	-10.7408
0.1995	0.696705	0.221	-5.40542	0.119	0.34578	0.1405	1.72846	0.162	-10.7408
0.2	2.08959	0.2215	-4.18392	0.1195	0.518653	0.141	2.24679	0.1625	-11.0879
0.2005	0.696705	0.222	-6.10366	0.12	-0.69169	0.1415	2.59229	0.163	-11.2615
0.201	0.696705	0.2225	-5.40542	0.1205	0.34578	0.142	3.45584	0.1635	-11.0879
0.2015	1.04499	0.223	-4.18392	0.121	-0.172906	0.1425	4.83695	0.164	-10.9143
0.202	0.522545	0.2235	-4.00946	0.1215	0.518653	0.143	5.52725	0.1645	-9.00555
0.2025	1.56734	0.224	-4.00946	0.122	0.34578	0.1435	6.38987	0.165	-11.7824
0.203	1.21912	0.2245	-4.00946	0.1225	0.172895	0.144	6.90732	0.1655	-11.6088
0.2035	0.696705	0.123	0.172895	0.123	0.172895	0.1445	6.56237	0.166	-12.1297
0.204	2.4377	0.1235	1.5234E-13	0.1235	1.5234E-13	0.145	5.6998		
0.2045	0.870854	0.124	-0.345823	0.124	-0.345823	0.1455	4.31912		
0.205	0.522545	0.1245	0.172895	0.1245	0.172895	0.146	2.76502		
0.2055	0.870854	0.125	0.172895	0.125	0.172895	0.1465	1.38286		
0.206	2.26365	0.1255	0.34578	0.1255	0.34578	0.147	0.34578		
0.2065	0	0.126	-0.172906	0.126	-0.172906	0.1475	-1.21057		
0.207	1.56734	0.1265	0	0.1265	0	0.148	-2.7678		
0.2075	-0.174204	0.127	0.172895	0.127	0.172895	0.1485	-4.84549		
0.208	0.174193	0.1275	-1.0376	0.1275	-1.0376	0.149	-5.88492		
0.2085	4.35153	0.128	-0.345823	0.128	-0.345823	0.1495	-6.57809		
0.209	-1.04539	0.1285	0	0.1285	0	0.15	-7.96495		
0.2095	-0.348418	0.129	0	0.129	0	0.1505	-8.13836		
0.21	2.08959	0.1295	0	0.1295	0	0.151	-8.65864		
0.2105	-1.39394	0.13	0.34578	0.13	0.34578	0.1515	-8.83209		
0.211	-1.56823	0.1305	-0.518751	0.1305	-0.518751	0.152	-9.00555		
0.2115	-2.61421	0.131	0.34578	0.131	0.34578	0.1525	-9.00555		
0.212	-2.43985	0.1315	-0.172906	0.1315	-0.172906	0.153	-9.35251		
0.2125	-2.78858	0.132	0.172895	0.132	0.172895	0.1535	-9.35251		
0.213	-2.96296	0.1325	0.172895	0.1325	0.172895	0.154	-10.9143		
0.2135	-3.48616	0.133	0.518653	0.133	0.518653	0.1545	-9.00555		

Gauge33_6 Time msec	Gauge33_6 Stress MPa	Gauge33_6 Time msec	Gauge33_6 Stress MPa	Gauge33_6 Time msec	Gauge33_6 Stress MPa	Gauge33_6 Time msec	Gauge33_6 Stress MPa	Gauge33_6 Time msec	Gauge33_6 Stress MPa
0.094	0.17551	0.1155	0	0.137	-1.40448	0.1585	0.526497	0.18	-0.526596
0.0945	0	0.116	0	0.1375	-1.58009	0.159	1.05289	0.1805	-0.351053
0.095	1.5464E-13	0.1165	0	0.138	-0.526596	0.1595	0.877439	0.181	-0.351053
0.0955	-0.175521	0.117	0	0.1385	-1.22888	0.16	1.40377	0.1815	-0.526596
0.096	0.17551	0.1175	1.93	0.139	-0.877715	0.1605	1.22834	0.182	-0.70215
0.0965	0	0.118	0	0.1395	-1.40448	0.161	1.7546	0.1825	-0.351053
0.097	0.351009	0.1185	0.17551	0.14	-1.05329	0.1615	1.22834	0.183	-0.351053
0.0975	0.351009	0.119	0	0.1405	-1.58009	0.162	1.22834	0.1835	-0.526596
0.098	0.17551	0.1195	0	0.141	-1.40448	0.1625	1.22834	0.184	-0.351053
0.0985	0.351009	0.12	0.17551	0.1415	-1.22888	0.163	1.05289	0.1845	0
0.099	0.17551	0.1205	0	0.142	-1.22888	0.1635	0.701973	0.185	0.351009
0.0995	0.351009	0.121	0	0.1425	-0.877715	0.164	0.877439	0.1855	0.526497
0.1	3.1178E-13	0.1215	0	0.143	-0.877715	0.1645	0.877439	0.186	0.701973
0.1005	0.17551	0.122	0.17551	0.1435	-0.351053	0.165	0.526497	0.1865	0.701973
0.101	0.17551	0.1225	7.01178	0.144	-0.175521	0.1655	0.17551	0.187	1.05289
0.1015	0.351009	0.123	0.17551	0.1445	0.17551	0.166	0	0.1875	0.877439
0.102	0.351009	0.1235	0	0.145	0.145	0.1665	-0.175521	0.188	0.877439
0.1025	0.17551	0.124	-1.22888	0.1455	1.40377	0.167	-0.351053	0.1885	0.877439
0.103	0.17551	0.1245	-0.70215	0.146	0.526497	0.1675	-0.175521	0.189	0.526497
0.1035	0.526497	0.125	0.526497	0.1465	0.701973	0.168	-0.526596	0.1895	0.526497
0.104	0.526497	0.1255	0.351009	0.147	0.526497	0.1685	-0.175521	0.19	0
0.1045	0.351009	0.126	0.17551	0.1475	0.526497	0.169	-0.526596	0.1905	0.351009
0.105	0.17551	0.1265	0	0.148	0.351009	0.1695	-0.526596	0.191	0.17551
0.1055	0.17551	0.127	-0.526596	0.1485	0.17551	0.17	-0.351053	0.1915	-0.175521
0.106	0	0.1275	0	0.149	0	0.1705	-0.175521	0.192	-0.526596
0.1065	0.17551	0.128	0	0.1495	0	0.171	-0.175521	0.1925	-0.70215
0.107	0.17551	0.1285	0	0.15	0	0.1715	-0.175521	0.193	-0.351053
0.1075	0	0.129	0	0.1505	0	0.172	0	0.1935	-0.351053
0.108	-0.175521	0.1295	0	0.151	0	0.1725	0.351009	0.194	-0.351053
0.1085	0.17551	0.13	0	0.1515	0	0.173	0.701973	0.1945	0
0.109	0.17551	0.1305	0	0.152	0	0.1735	1.22834	0.195	0
0.1095	0.351009	0.131	0	0.1525	1.5464E-13	0.174	1.40377	0.1955	-0.175521
0.11	0	0.1315	0	0.153	-0.175521	0.1745	1.57919	0.196	1.5464E-13
0.1105	-0.175521	0.132	0	0.1535	-0.175521	0.175	1.57919	0.1965	0
0.111	0	0.1325	0	0.154	-0.175521	0.1755	1.93	0.197	0.17551
0.1115	-0.175521	0.133	0	0.1545	0	0.176	1.93	0.1975	0.351009
0.112	-1.546E-13	0.1335	0	0.155	0	0.1765	1.93	0.198	0.351009
0.1125	0.351009	0.134	0	0.1555	-0.175521	0.177	1.40377	0.1985	0.526497
0.113	0	0.1345	0	0.156	-0.175521	0.1775	1.22834	0.199	0.351009
0.1135	0	0.135	0	0.1565	-0.175521	0.178	1.05289	0.1995	0.351009
0.114	0.17551	0.1355	-0.351053	0.157	-0.175521	0.1785	0.701973	0.2	0.17551
0.1145	0.351009	0.136	-0.351053	0.1575	0	0.179	0.351009	0.2005	0.17551
0.115	0	0.1365	-0.351053	0.158	0.351009	0.1795	0	0.201	1.5464E-13
Gauge33_6 Time msec	Gauge33_6 Stress MPa	Gauge33_6 Time msec	Gauge33_6 Stress MPa	Gauge33_6 Time msec	Gauge33_6 Stress MPa	Gauge33_6 Time msec	Gauge33_6 Stress MPa	Gauge33_6 Time msec	Gauge33_6 Stress MPa
0.2015	-0.526596	0.223	-1.58009	0.202	0	0.2235	-1.22888	0.2025	-0.351053
0.202	0	0.2235	-1.22888	0.2025	-0.351053	0.224	-1.40448	0.203	-0.351053
0.2025	-0.351053	0.224	-1.40448	0.203	-0.351053	0.2245	-5.27044	0.2035	-0.70215
0.203	-0.351053	0.2245	-5.27044	0.2035	-0.70215	0.225	-1.75571	0.204	-0.175521
0.2035	-0.70215	0.225	-1.75571	0.204	-0.175521	0.2255	-0.70215	0.2045	0
0.204	-0.175521	0.2255	-0.70215	0.2045	0	0.226	-0.526596	0.205	-0.70215
0.2045	0	0.226	-0.526596	0.205	-0.70215	0.2265	0	0.2055	-0.351053
0.205	-0.70215	0.2265	0	0.2055	-0.351053	0.227	1.40377	0.206	-0.351053
0.2055	-0.351053	0.227	1.40377	0.206	-0.351053	0.2275	2.45613	0.2065	0.526497
0.206	-0.351053	0.2275	2.45613	0.2065	0.526497	0.228	2.98217	0.207	-0.526596
0.2065	0.526497	0.228	2.98217	0.207	-0.526596	0.2285	3.5081	0.2075	-0.526596
0.207	-0.526596	0.2285	3.5081	0.2075	-0.526596	0.229	3.15749	0.208	-0.526596
0.2075	-0.526596	0.229	3.15749	0.208	-0.526596	0.2295	2.80683	0.2085	0.351009
0.208	-0.526596	0.2295	2.80683	0.2085	0.351009	0.23	1.93	0.209	0.17551
0.2085	0.351009	0.23	1.93	0.209	0.17551	0.2305	2.28077	0.2095	1.5464E-13
0.209	0.17551	0.2305	2.28077	0.2095	1.5464E-13	0.231	1.40377	0.21	0.351009
0.2095	1.5464E-13	0.231	1.40377	0.21	0.351009	0.2315	0.351009	0.2105	0
0.21	0.351009	0.2315	0.351009	0.2105	0	0.232	0.351009	0.211	0.17551
0.2105	0	0.232	0.351009	0.211	0.17551	0.2325	-1.546E-13	0.2115	0
0.211	0.17551	0.2325	-1.546E-13	0.2115	0	0.233	-0.526596	0.212	0
0.2115	0	0.233	-0.526596	0.212	0	0.2335	-2.10698	0.2125	-0.351053
0.212	0	0.2335	-2.10698	0.2125	-0.351053	0.234	-1.75571	0.213	-1.546E-13
0.2125	-0.351053	0.234	-1.75571	0.213	-1.546E-13	0.2345	-2.10698	0.2135	-0.175521
0.213	-1.546E-13	0.2345	-2.10698	0.2135	-0.175521	0.214	-0.526596	0.2145	-1.05329
0.2135	-0.175521	0.214	-0.526596	0.2145	-1.05329	0.215	-0.70215	0.2155	-0.70215
0.214	-0.526596	0.215	-0.70215	0.2155	-0.70215	0.216	-0.70215	0.2165	-0.526596
0.2145	-1.05329	0.216	-0.70215	0.2165	-0.526596	0.217	-0.877715	0.2175	-0.70215
0.215	-0.70215	0.2165	-0.526596	0.217	-0.877715	0.2175	-0.70215	0.218	-0.70215
0.2155	-0.70215	0.217	-0.877715	0.2175	-0.70215	0.218	-0.70215	0.2185	-0.70215
0.216	-0.70215	0.2175	-0.70215	0.218	-0.70215	0.2185	-0.70215	0.219	-1.22888
0.2165	-0.526596	0.218	-0.70215	0.2185	-0.70215	0.219	-1.22888	0.2195	-1.22888
0.217	-0.877715	0.2185	-0.70215	0.219	-1.22888	0.22	-1.58009	0.2205	-1.58009
0.2175	-0.70215	0.219	-1.22888	0.22	-1.58009	0.2205	-1.58009	0.221	-1.40448
0.218	-0.70215	0.22	-1.58009	0.2205	-1.58009	0.221	-1.40448	0.2215	-1.40448
0.2185	-0.70215	0.2205	-1.58009	0.221	-1.40448	0.2215	-1.40448	0.222	-1.58009
0.219	-1.22888	0.221	-1.40448	0.2215	-1.40448	0.222	-1.58009	0.2225	-1.58009
0.2195	-1.22888	0.2215	-1.40448	0.222	-1.58009	0.2225	-1.58009		





Gauge34_3	Gauge34_3	Gauge34_3	Gauge34_3	Gauge34_3	Gauge34_3	Gauge34_3	Gauge34_3	Gauge34_3	Gauge34_3
Time	Stress	Time	Stress	Time	Stress	Time	Stress	Time	Stress
msec	MPa	msec	MPa	msec	MPa	msec	MPa	msec	MPa
0.0585	0	0.08	-5.86454	0.1015	-24.4264	0.123	-20.8474	0.1445	-16.9157
0.059	0	0.0805	-6.22036	0.102	-24.4264	0.1235	-20.1321	0.145	-16.9157
0.0595	0.177523	0.081	-6.39829	0.1025	-24.6054	0.124	-19.2383	0.1455	-16.9157
0.06	0.355036	0.0815	-6.57622	0.103	-24.4264	0.1245	-18.7022	0.146	-17.0943
0.0605	0.355036	0.082	-6.75417	0.1035	-24.4264	0.125	-17.8088	0.1465	-17.0943
0.061	0.867505	0.0825	-6.93213	0.104	-24.4264	0.1255	-17.0943	0.147	-17.0943
0.0615	1.41987	0.083	-7.64408	0.1045	-24.4264	0.126	-16.5585	0.1475	-17.0943
0.062	2.48431	0.0835	-8.17816	0.105	-24.6054	0.1265	-15.8444	0.148	-17.0943
0.0625	4.08021	0.084	-8.71234	0.1055	-24.4264	0.127	-15.3088	0.1485	-16.9157
0.063	5.85237	0.0845	-9.24662	0.106	-24.4264	0.1275	-14.9519	0.149	-17.0943
0.0635	7.62341	0.085	-9.95915	0.1065	-24.6054	0.128	-14.7734	0.1495	-16.9157
0.064	9.03944	0.0855	-10.1373	0.107	-24.6054	0.1285	-14.595	0.15	-16.9157
0.0645	9.39334	0.086	-10.3155	0.1075	-24.6054	0.129	-14.7734	0.1505	-16.5585
0.065	9.74719	0.0865	-10.6719	0.108	-24.6054	0.1295	-14.4165	0.151	-16.0229
0.0655	9.39334	0.087	-11.0283	0.1085	-24.6054	0.13	-14.595	0.1515	-16.2014
0.066	8.50852	0.0875	-11.7413	0.109	-24.2473	0.1305	-14.7734	0.152	-16.5585
0.0665	7.62341	0.088	-12.2761	0.1095	-23.8692	0.131	-14.7734	0.1525	-16.5585
0.067	6.91513	0.0885	-13.1678	0.11	-23.1732	0.1315	-14.595	0.153	-16.5585
0.0675	6.91513	0.089	-14.2381	0.1105	-23.3522	0.132	-14.595	0.1535	-16.5585
0.068	6.73803	0.0895	-14.9519	0.111	-23.3522	0.1325	-14.9519	0.154	-16.5585
0.0685	7.09222	0.09	-15.4873	0.1115	-22.9942	0.133	-14.595	0.1545	-16.5585
0.069	7.44636	0.0905	-16.0229	0.112	-22.8153	0.1335	-14.4165	0.155	-16.7371
0.0695	8.50852	0.091	-16.38	0.1125	-22.8153	0.134	-14.595	0.1555	-16.7371
0.07	8.86248	0.0915	-16.7371	0.113	-22.2785	0.1345	-14.9519	0.156	-16.9157
0.0705	9.2164	0.092	-17.4515	0.1135	-22.2785	0.135	-14.9519	0.1565	-17.2729
0.071	8.86248	0.0925	-17.9674	0.114	-22.6363	0.1355	-15.1303	0.157	-17.2729
0.0715	8.86248	0.093	-18.8809	0.1145	-22.9942	0.136	-15.3088	0.1575	-17.2729
0.072	7.80046	0.0935	-19.4171	0.115	-23.1732	0.1365	-15.3088	0.158	-17.6301
0.0725	6.56092	0.094	-19.9534	0.1155	-22.9942	0.137	-15.6658	0.1585	-17.6301
0.073	5.49803	0.0945	-20.3109	0.116	-23.1732	0.1375	-15.8444	0.159	-17.8088
0.0735	4.08021	0.095	-20.8474	0.1165	-23.5312	0.138	-16.38	0.1595	-17.6301
0.074	2.83903	0.0955	-21.0262	0.117	-23.5312	0.1385	-16.38	0.16	-17.6301
0.0745	1.24243	0.096	-21.384	0.1175	-23.7102	0.139	-16.5585	0.1605	-17.8088
0.075	0	0.0965	-21.7417	0.118	-23.5312	0.1395	-16.9157	0.161	-17.9874
0.0755	-1.06538	0.097	-22.0995	0.1185	-23.7102	0.14	-17.0943	0.1615	-17.6301
0.076	-2.13115	0.0975	-22.6363	0.119	-23.7102	0.1405	-16.7371	0.162	-17.4515
0.0765	-3.01961	0.098	-22.8153	0.1195	-23.1732	0.141	-16.9157	0.1625	-17.6301
0.077	-3.55282	0.0985	-23.1732	0.12	-23.1732	0.1415	-16.9157	0.163	-17.2729
0.0775	-3.73057	0.099	-23.7102	0.1205	-22.6363	0.142	-16.9157	0.1635	-17.6301
0.078	-3.73057	0.0995	-23.8892	0.121	-22.2785	0.1425	-16.9157	0.164	-17.2729
0.0785	-4.44172	0.1	-24.2473	0.1215	-22.0995	0.143	-16.7371	0.1645	-17.0943
0.079	-4.61953	0.1005	-24.2473	0.122	-21.5626	0.1435	-16.9157	0.165	-17.0943
0.0795	-5.50877	0.101	-24.4264	0.1225	-20.8474	0.144	-16.9157	0.1655	-16.9157

Gauge34_3	Gauge34_3	Gauge34_3	Gauge34_3	Gauge34_3	Gauge34_3	Gauge34_4	Gauge34_4	Gauge34_4	Gauge34_4
Time	Stress	Time	Stress	Time	Stress	Time	Stress	Time	Stress
msec	MPa	msec	MPa	msec	MPa	msec	MPa	msec	MPa
0.166	-16.7371	0.1875	-8.35621	0.209	-6.75417	0.089	0	0.1105	0.172574
0.1665	-16.5585	0.188	-8.00012	0.2095	-7.28808	0.0895	0	0.111	0.172574
0.167	-16.0229	0.1885	-8.35621	0.21	-7.6221	0.09	0	0.1115	0.172574
0.1675	-15.6658	0.189	-8.35621	0.2105	-8.53427	0.0905	0	0.112	0.345137
0.168	-15.3088	0.1895	-8.00012	0.211	-8.71234	0.091	0	0.1125	0.172574
0.1685	-15.1303	0.19	-8.00012			0.0915	0	0.113	0.345137
0.169	-14.9519	0.1905	-8.00012			0.092	-0.172585	0.1135	0.69023
0.1695	-14.2381	0.191	-8.35621			0.0925	-0.34518	0.114	0.69023
0.17	-14.0597	0.1915	-8.00012			0.093	-0.172585	0.1145	0.862761
0.1705	-13.7029	0.192	-8.35621			0.0935	-0.172585	0.115	0.69023
0.171	-13.1678	0.1925	-8.35621			0.094	-0.172585	0.1155	0.862761
0.1715	-12.9894	0.193	-8.35621			0.0945	-0.34518	0.116	1.03528
0.172	-12.4544	0.1935	-8.35621			0.095	-0.34518	0.1165	1.20779
0.1725	-12.0978	0.194	-8.00012			0.0955	0	0.117	1.38029
0.173	-11.9195	0.1945	-8.00012			0.096	-0.172585	0.1175	1.55277
0.1735	-11.563	0.195	-8.00012			0.0965	-0.34518	0.118	1.72525
0.174	-11.3847	0.1955	-7.64408			0.097	-0.34518	0.1185	1.89772
0.1745	-10.6719	0.196	-7.46608			0.0975	-0.34518	0.119	2.07017
0.175	-10.4937	0.1965	-7.28808			0.098	-0.517787	0.1195	2.75988
0.1755	-10.3155	0.197	-7.28808			0.0985	-0.34518	0.12	3.62177
0.176	-8.35621	0.1975	-6.75417			0.099	-0.34518	0.1205	4.82796
0.1765	-9.42474	0.198	-6.57622			0.0995	-0.34518	0.121	6.20582
0.177	-9.24662	0.1985	-6.39829			0.1	-0.34518	0.1215	8.09923
0.1775	-9.06852	0.199	-6.22036			0.1005	-0.34518	0.122	9.47543
0.178	-8.89042	0.1995	-5.86665			0.101	-0.34518	0.1225	10.8509
0.1785	-9.06852	0.2	-5.50877			0.1015	-0.34518	0.123	11.0228
0.179	-8.89042	0.2005	-4.97519			0.102	-0.172585	0.1235	9.47543
0.1795	-8.89042	0.201	-4.79736			0.1025	0.172574	0.124	7.75507
0.18	-8.71234	0.2015	-4.44172			0.103	0.172574	0.1245	6.20582
0.1805	-8.53427	0.202	-4.26392			0.1035	0	0.125	5.00023
0.181	-8.89042	0.2025	-3.90834			0.104	0.172574	0.1255	3.96645
0.1815	-8.71234	0.203	-3.73057			0.1045	0.172574	0.126	3.27705
0.182	-8.89042	0.2035	-3.55282			0.105	0	0.1265	2.41505
0.1825	-8.71234	0.204	-3.37507			0.1055	0.172574	0.127	2.07017
0.183	-8.53427	0.2045	-3.90834			0.106	0.172574	0.1275	1.72525
0.1835	-8.35621	0.205	-3.90834			0.1065	0.172574	0.128	1.72525
0.184	-8.71234	0.2055	-4.08612			0.107	0.172574	0.1285	1.72525
0.1845	-8.53427	0.206	-4.26392			0.1075	0	0.129	1.20779
0.185	-8.53427	0.2065	-4.44172			0.108	-0.172585	0.1295	1.03528
0.1855	-8.53427	0.207	-4.79736			0.1085	0	0.13	0.517689
0.186	-8.35621	0.2075	-5.3309			0.109	-0.172585	0.1305	0.345137
0.1865	-8.35621	0.208	-5.68665			0.1095	0	0.131	0
0.187	-8.35621	0.2085	-6.22036			0.11	0	0.1315	-0.517787

GaugeJ4_4	GaugeJ4_4	GaugeJ4_4	GaugeJ4_4	GaugeJ4_4	GaugeJ4_4	GaugeJ4_4	GaugeJ4_4	GaugeJ4_4	GaugeJ4_4
Time	Stress	Time	Stress	Time	Stress	Time	Stress	Time	Stress
msec	MPa	msec	MPa	msec	MPa	msec	MPa	msec	MPa
0.132	-0.863032	0.1535	-1.12406	0.175	-1.38098	0.1965	1.89772	0.218	-1.03567
0.1325	-1.38098	0.154	-1.08941	0.1755	-1.03567	0.197	1.89772	0.2185	-1.20832
0.133	-2.07173	0.1545	-10.3743	0.176	0.345137	0.1975	1.89772	0.219	-1.03567
0.1335	-2.58991	0.155	-9.85467	0.1765	-0.690404	0.198	1.72525	0.2195	-1.20832
0.134	-3.28097	0.1555	-9.5083	0.177	-0.34518	0.1985	1.72525	0.22	-1.03567
0.1345	-3.9722	0.156	-9.33513	0.1775	-0.34518	0.199	1.55277	0.2205	-0.863032
0.135	-3.9722	0.1565	-9.16197	0.178	0	0.1995	1.38029	0.221	-0.863032
0.1355	-4.49074	0.157	-9.16197	0.1785	0	0.2	1.20779	0.2215	-0.34518
0.136	-5.18227	0.1575	-9.16197	0.179	0	0.2005	1.03528	0.222	-0.34518
0.1365	-5.70103	0.158	-8.98882	0.1795	0	0.201	1.03528	0.2225	0
0.137	-5.87398	0.1585	-8.81568	0.18	-0.172585	0.2015	0.69023	0.223	0.172574
0.1375	-6.39287	0.159	-8.64255	0.1805	0	0.202	0.69023	0.2235	0.69023
0.138	-6.91187	0.1595	-8.46943	0.181	-0.172585	0.2025	0.517689	0.224	0.862761
0.1385	-7.43096	0.16	-8.12323	0.1815	-0.172585	0.203	0.517689	0.2245	1.03528
0.139	-7.95015	0.1605	-8.12323	0.182	-0.172585	0.2035	0.517689	0.225	1.38029
0.1395	-8.29633	0.161	-7.95015	0.1825	-0.34518	0.204	0.517689	0.2255	1.38029
0.14	-8.64255	0.1615	-7.60401	0.183	0.172574	0.2045	0.517689	0.226	1.72525
0.1405	-8.98882	0.162	-7.43096	0.1835	0.172574	0.205	0.517689	0.2265	2.07017
0.141	-8.98882	0.1625	-7.25792	0.184	0.517689	0.2055	0.517689	0.227	2.41505
0.1415	-8.98882	0.163	-6.73886	0.1845	0.69023	0.206	0.69023	0.2275	2.58747
0.142	-9.33513	0.1635	-6.73886	0.185	0.862761	0.2065	0.69023	0.228	2.75988
0.1425	-9.33513	0.164	-6.39287	0.1855	1.03528	0.207	0.69023	0.2285	2.58747
0.143	-9.68148	0.1645	-6.39287	0.186	1.03528	0.2075	0.69023	0.229	3.10467
0.1435	-9.68148	0.165	-6.2199	0.1865	1.03528	0.208	0.69023	0.2295	2.75988
0.144	-9.68148	0.1655	-6.2199	0.187	1.20779	0.2085	0.345137	0.23	2.75988
0.1445	-10.0279	0.166	-5.87398	0.1875	1.38029	0.209	0.345137	0.2305	2.75988
0.145	-10.0279	0.1665	-5.35518	0.188	1.38029	0.2095	1.5206E-13	0.231	2.75988
0.1455	-10.0279	0.167	-4.83648	0.1885	1.38029	0.21	0.172574	0.2315	2.75988
0.146	-10.5476	0.1675	-4.31788	0.189	1.38029	0.2105	0	0.232	2.58747
0.1465	-10.5476	0.168	-4.14503	0.1895	1.55277	0.211	-0.172585	0.2325	2.75988
0.147	-10.7208	0.1685	-3.9722	0.19	1.55277	0.2115	-0.172585	0.233	2.58747
0.1475	-10.8941	0.169	-3.62656	0.1905	1.72525	0.212	-0.34518	0.2335	2.58747
0.148	-11.2406	0.1695	-3.62656	0.191	1.55277	0.2125	-0.690404	0.234	2.58747
0.1485	-11.2406	0.17	-3.45376	0.1915	1.55277	0.213	-0.690404	0.2345	2.24261
0.149	-11.5872	0.1705	-3.28097	0.192	1.55277	0.2135	-0.863032	0.235	2.24261
0.1495	-11.5872	0.171	-3.10819	0.1925	1.72525	0.214	-0.863032	0.2355	2.07017
0.15	-11.5872	0.1715	-2.93542	0.193	1.72525	0.2145	-1.03567	0.236	2.24261
0.1505	-11.9338	0.172	-2.76266	0.1935	1.89772	0.215	-0.863032	0.2365	2.07017
0.151	-11.7605	0.1725	-2.41718	0.194	1.72525	0.2155	-0.863032	0.237	2.07017
0.1515	-11.7605	0.173	-2.24445	0.1945	1.72525	0.216	-0.863032	0.2375	1.89772
0.152	-11.9338	0.1735	-1.89903	0.195	1.72525	0.2165	-0.863032	0.238	1.72525
0.1525	-11.9338	0.174	-1.72634	0.1955	1.89772	0.217	-1.03567		
0.153	-11.4139	0.1745	-1.55365	0.196	1.89772	0.2175	-1.03567		

GaugeJ4_5	GaugeJ4_5	GaugeJ4_5	GaugeJ4_5	GaugeJ4_5	GaugeJ4_5	GaugeJ4_5	GaugeJ4_5	GaugeJ4_5	GaugeJ4_5
Time	Stress	Time	Stress	Time	Stress	Time	Stress	Time	Stress
msec	MPa	msec	MPa	msec	MPa	msec	MPa	msec	MPa
0.03	0	0.0515	0.534581	0.073	-0.712932	0.0945	-0.356443	0.116	1.95964
0.0305	-0.356443	0.052	0.356399	0.0735	-0.534682	0.095	-0.534682	0.1165	1.95964
0.031	-0.356443	0.0525	0.534581	0.074	-0.356443	0.0955	-0.356443	0.117	2.13772
0.0315	-0.356443	0.053	0.712752	0.0745	-0.356443	0.096	-0.534682	0.1175	2.13772
0.032	-0.356443	0.0535	0.712752	0.075	-0.534682	0.0965	-0.712932	0.118	2.13772
0.0325	0	0.054	0.712752	0.0755	-3.14E-13	0.097	-0.712932	0.1185	2.31579
0.033	-0.356443	0.0545	0.890912	0.076	0.178205	0.0975	-0.534682	0.119	2.31579
0.0335	-0.356443	0.055	1.06906	0.0765	0	0.098	-0.534682	0.1195	2.84993
0.034	0	0.0555	0.890912	0.077	0.356399	0.0985	-0.534682	0.12	3.38397
0.0345	0	0.056	0.890912	0.0775	0.356399	0.099	-0.712932	0.1205	3.73995
0.035	-0.178216	0.0565	0.712752	0.078	0.534581	0.0995	-0.534682	0.121	4.9855
0.0355	-1.57E-13	0.057	0.712752	0.0785	1.06906	0.1	-0.712932	0.1215	6.2305
0.036	0.890912	0.0575	0.534581	0.079	0.712752	0.1005	-0.534682	0.122	8.00811
0.0365	0.356399	0.058	0.356399	0.0795	0.712752	0.101	-0.534682	0.1225	9.9622
0.037	0.534581	0.0585	0.356399	0.08	0.890912	0.1015	-0.356443	0.123	12.0924
0.0375	0.712752	0.059	0.356399	0.0805	1.06906	0.102	-0.356443	0.1235	13.1569
0.038	0.534581	0.0595	0.178205	0.081	1.06906	0.1025	-0.356443	0.124	13.3342
0.0385	0.712752	0.06	0.356399	0.0815	1.06906	0.103	-0.178216	0.1245	12.2698
0.039	1.06906	0.0605	0.356399	0.082	1.06906	0.1035	-0.178216	0.125	10.4949
0.0395	1.06906	0.061	0.356399	0.0825	1.2472	0.104	0	0.1255	8.71885
0.04	0.890912	0.0615	0.356399	0.083	1.2472	0.1045	0	0.126	6.2305
0.0405	1.2472	0.062	0.178205	0.0835	1.06906	0.105	0.178205	0.1265	4.27382
0.041	1.2472	0.0625	0.178205	0.084	1.42533	0.1055	0.356399	0.127	3.02796
0.0415	1.06906	0.063	0.356399	0.0845	1.2472	0.106	0.712752	0.1275	1.78154
0.042	1.06906	0.0635	0.356399	0.085	1.42533	0.1065	0.712752	0.128	0.890912
0.0425	1.06906	0.064	0.178205	0.0855	1.2472	0.107	0.712752	0.1285	0.356399
0.043	1.06906	0.0645	0.178205	0.086	1.2472	0.1075	1.06906	0.129	-0.356443
0.0435	1.06906	0.065	0	0.0865	1.06906	0.108	1.2472	0.1295	-0.534682
0.044	1.06906	0.0655	0	0.087	1.2472	0.1085	1.06906	0.13	-0.712932
0.0445	1.06906	0.066	-0.356443	0.0875	0.890912	0.109	1.60344	0.1305	-1.06947
0.045	0.890912	0.0665	-0.178216	0.088	0.890912	0.1095	1.42533	0.131	-1.42604
0.0455	0.890912	0.067	-0.534682	0.0885	0.890912	0.11	1.42533	0.1315	-1.60435
0.046	0.890912	0.0675	-0.178216	0.089	0.712752	0.1105	1.78154	0.132	-2.13933
0.0465	0.890912	0.068	-0.534682	0.0895	0.712752	0.111	1.60344	0.1325	-2.8528
0.047	0.534581	0.0685	-0.534682	0.09	0.534581	0.1115	1.78154	0.133	-3.38803
0.0475	0.534581	0.069	-0.534682	0.0905	0.356399	0.112	1.95964	0.1335	-3.74489
0.048	0.534581	0.0695	-0.534682	0.091	0.178205	0.1125	1.95964	0.134	-4.63727
0.0485	0.356399	0.07	-0.891193	0.0915	0.178205	0.113	2.13772	0.1345	-4.99429
0.049	0.178205	0.0705	-0.712932	0.092	0.178205	0.1135	1.95964	0.135	-5.88706
0.0495	0.356399	0.071	-0.534682	0.0925	0	0.114	2.13772	0.1355	-6.24424
0.05	0.356399	0.0715	-0.712932	0.093	-0.178216	0.1145	1.78154	0.136	-6.7801
0.0505	0.534581	0.072	-0.712932	0.0935	-0.178216	0.115	1.95964	0.1365	-7.67343
0.051	0.534581	0.0725	-0.534682	0.094	-0.356443	0.1155	1.95964	0.137	-8.20955

GaugeJ4_5 Time msec	GaugeJ4_5 Stress MPa	GaugeJ4_5 Time msec	GaugeJ4_5 Stress MPa	GaugeJ4_5 Time msec	GaugeJ4_5 Stress MPa	GaugeJ4_5 Time msec	GaugeJ4_5 Stress MPa	GaugeJ4_6 Time msec	GaugeJ4_6 Stress MPa
0.1375	-8.74579	0.159	-19.671	0.1805	-4.28028	0.202	-1.96099	-0.029	-2.09905
0.138	-9.63973	0.1595	-20.03	0.181	-4.10181	0.2025	-2.13933	-0.0285	-2.27404
0.1385	-10.1762	0.16	-20.03	0.1815	-3.92335	0.203	-2.13933	-0.028	-2.27404
0.139	-10.7128	0.1605	-20.3889	0.182	-3.74489	0.2035	-2.13933	-0.0275	-2.27404
0.1395	-11.0706	0.161	-20.9274	0.1825	-3.56645	0.204	-2.13933	-0.027	-2.09905
0.14	-11.6074	0.1615	-21.466	0.183	-3.38803	0.2045	-1.96099	-0.0265	-2.27404
0.1405	-11.9653	0.162	-21.8252	0.1835	-3.56645	0.205	-2.13933	-0.026	-2.27404
0.141	-12.5022	0.1625	-21.8252	0.184	-3.56645	0.2055	-2.13933	-0.0255	-2.27404
0.1415	-13.0393	0.163	-22.364	0.1845	-3.74489	0.206	-2.13933	-0.025	-2.09905
0.142	-13.7555	0.1635	-22.5436	0.185	-3.92335	0.2065	-2.13933	-0.0245	-2.09905
0.1425	-13.5764	0.164	-22.5436	0.1855	-3.92335	0.207	-2.13933	-0.024	-2.09905
0.143	-13.3973	0.1645	-22.9029	0.186	-3.92335	0.2075	-2.13933	-0.0235	-2.27404
0.1435	-13.3973	0.165	-22.7232	0.1865	-4.28028	0.208	-1.78267	-0.023	-2.09905
0.144	-13.3973	0.1655	-22.364	0.187	-4.28028	0.2085	-1.60435	-0.0225	-2.09905
0.1445	-13.3973	0.166	-22.364	0.1875	-4.45877	0.209	-1.24775	-0.022	-2.27404
0.145	-13.3973	0.1665	-22.0048	0.188	-4.81577	0.2095	-1.06947	-0.0215	-2.27404
0.1455	-13.5764	0.167	-21.8252	0.1885	-4.81577	0.21	-0.891193	-0.021	-2.27404
0.146	-13.5764	0.1675	-21.466	0.189	-4.81577	0.2105	-0.534682	-0.0205	-2.27404
0.1465	-13.7555	0.168	-20.9274	0.1895	-4.81577	0.211	-0.178216	-0.02	-2.44904
0.147	-13.9346	0.1685	-20.3889	0.19	-4.99429	0.2115	0.178205	-0.0195	-2.27404
0.1475	-13.9346	0.169	-19.671	0.1905	-4.81577	0.212	1.5702E-13	-0.019	-2.27404
0.148	-14.1136	0.1695	-19.3122	0.191	-4.99429	0.2125	-0.178216	-0.0185	-2.27404
0.1485	-14.1136	0.17	-18.4152	0.1915	-4.99429	0.213	-1.57E-13	-0.018	-2.27404
0.149	-14.2927	0.1705	-17.5185	0.192	-4.81577	0.2135	-0.534682	-0.0175	-2.27404
0.1495	-14.4719	0.171	-16.6221	0.1925	-4.45877	0.214	-1.06947	-0.017	-2.09905
0.15	-15.0093	0.1715	-16.0844	0.193	-4.45877	0.2145	-1.42604	-0.0165	-2.09905
0.1505	-15.1884	0.172	-15.3676	0.1935	-4.10181	0.215	-1.78267	-0.016	-2.27404
0.151	-15.1884	0.1725	-14.2927	0.194	-4.10181	0.2155	-2.13933	-0.0155	-2.27404
0.1515	-15.3676	0.173	-13.7555	0.1945	-3.92335	0.216	-2.8528	-0.015	-2.44904
0.152	-15.5468	0.1735	-12.6812	0.195	-3.74489	0.2165	-3.0312	-0.0145	-2.09905
0.1525	-15.5468	0.174	-12.3232	0.1955	-3.56645	0.217	-3.74489	-0.014	-2.27404
0.153	-16.0844	0.1745	-11.2495	0.196	-3.20961	0.2175	-4.28028	-0.0135	-2.27404
0.1535	-16.0844	0.175	-10.7128	0.1965	-3.0312	0.218	-4.63727	-0.013	-2.09905
0.154	-16.0844	0.1755	-9.99738	0.197	-2.8528	0.2185	-4.99429	-0.0125	-2.09905
0.1545	-16.0844	0.176	-8.56703	0.1975	-2.67442	0.219	-5.52992	-0.012	-2.27404
0.155	-16.4429	0.1765	-8.20955	0.198	-2.49605			-0.0115	-2.27404
0.1555	-16.6221	0.177	-7.67343	0.1985	-2.31768			-0.011	-2.27404
0.156	-17.1599	0.1775	-6.95874	0.199	-2.13933			-0.0105	-2.09905
0.1565	-17.5185	0.178	-6.42285	0.1995	-1.96099			-0.01	-2.27404
0.157	-17.8772	0.1785	-5.70848	0.2	-2.31768			-0.0095	-2.27404
0.1575	-18.4152	0.179	-5.35136	0.2005	-2.13933			-0.009	-2.27404
0.158	-18.9533	0.1795	-4.99429	0.201	-1.78267			-0.0085	-2.09905
0.1585	-19.4916	0.18	-4.81577	0.2015	-1.78267			-0.008	-2.27404

GaugeJ4_6 Time msec	GaugeJ4_6 Stress MPa	GaugeJ4_6 Time msec	GaugeJ4_6 Stress MPa	GaugeJ4_6 Time msec	GaugeJ4_6 Stress MPa	GaugeJ4_6 Time msec	GaugeJ4_6 Stress MPa	GaugeJ4_6 Time msec	GaugeJ4_6 Stress MPa
-0.0075	-2.09905	0.014	-0.17486	0.0355	0	0.057	0.174849	0.0785	0.699329
-0.007	-2.09905	0.0145	0	0.036	0.524514	0.0575	0.174849	0.079	0.874134
-0.0065	-2.09905	0.015	-0.17486	0.0365	-0.17486	0.058	0.174849	0.0795	0.699329
-0.006	-2.27404	0.0155	-0.349731	0.037	-0.349731	0.0585	0.174849	0.08	0.874134
-0.0055	-2.27404	0.016	-0.17486	0.0375	0	0.059	0.174849	0.0805	0.699329
-0.005	-2.09905	0.0165	-0.349731	0.038	0	0.0595	0.349687	0.081	0.699329
-0.0045	-2.09905	0.017	-0.349731	0.0385	-0.17486	0.06	0.174849	0.0815	0.699329
-0.004	-2.27404	0.0175	-0.17486	0.039	-0.349731	0.0605	0.349687	0.082	0.874134
-0.0035	-2.09905	0.018	0	0.0395	-0.17486	0.061	0.349687	0.0825	0.874134
-0.003	-2.09905	0.0185	0	0.04	-0.17486	0.0615	0.349687	0.083	1.04893
-0.0025	-2.27404	0.019	-0.349731	0.0405	0	0.062	0.349687	0.0835	0.874134
-0.002	-2.27404	0.0195	-0.17486	0.041	0	0.0625	0.349687	0.084	1.04893
-0.0015	-2.27404	0.02	-0.349731	0.0415	-1.541E-13	0.063	0.524514	0.0845	1.04893
-0.001	-2.09905	0.0205	-0.349731	0.042	-0.17486	0.0635	0.524514	0.085	1.22371
-0.0005	-2.09905	0.021	-0.17486	0.0425	0	0.064	0.524514	0.0855	1.04893
0	-2.27404	0.0215	-0.17486	0.043	-0.17486	0.0645	0.524514	0.086	1.04893
0.0005	-2.09905	0.022	0	0.0435	-0.17486	0.065	0.524514	0.0865	1.22371
0.001	-2.27404	0.0225	0	0.044	0	0.0655	0.524514	0.087	1.39848
0.0015	-2.27404	0.023	0.174849	0.0445	0	0.066	0.874134	0.0875	1.22371
0.002	-2.97412	0.0235	0.349687	0.045	-0.17486	0.0665	0.699329	0.088	1.04893
0.0025	-10.3356	0.024	0.174849	0.0455	0.174849	0.067	0.524514	0.0885	1.04893
0.003	-22.119	0.0245	0	0.046	0.174849	0.0675	0.699329	0.089	1.39848
0.0035	-9.10731	0.025	1.5406E-13	0.0465	0.349687	0.068	0.874134	0.0895	1.22371
0.004	-4.90024	0.0255	-1.541E-13	0.047	0	0.0685	0.699329	0.09	1.04893
0.0045	-3.67437	0.026	0	0.0475	0.349687	0.069	0.699329	0.0905	1.22371
0.005	0.524514	0.0265	0	0.048	0.349687	0.0695	0.874134	0.091	1.39848
0.0055	-0.524613	0.027	0	0.0485	0.524514	0.07	0.874134	0.0915	1.22371
0.006	-1.57414	0.0275	0.349687	0.049	0.349687	0.0705	0.874134	0.092	1.22371
0.0065	-1.39919	0.028	0	0.0495	0.349687	0.071	1.04893	0.0925	1.22371
0.007	-1.22425	0.0285	0	0.05	0.349687	0.0715	1.04893	0.093	1.39848
0.0075	-0.87441	0.029	0	0.0505	0.699329	0.072	0.874134	0.0935	1.57324
0.008	-0.524613	0.0295	-1.541E-13	0.051	0.524514	0.0725	1.04893	0.094	1.39848
0.0085	-0.524613	0.03	0	0.0515	0.524514	0.073	1.04893	0.0945	1.39848
0.009	-0.524613	0.0305	-0.17486	0.052	0.349687	0.0735	1.22371	0.095	1.57324
0.0095	-0.524613	0.031	0	0.0525	0.524514	0.074	1.22371	0.0955	1.39848
0.01	-0.524613	0.0315	-0.17486	0.053	0.174849	0.0745	1.39848	0.096	1.22371
0.0105	0	0.032	0.174849	0.0535	0.174849	0.075	1.39848	0.0965	1.57324
0.011	-0.349731	0.0325	0.349687	0.054	0	0.0755	1.04893	0.097	1.57324
0.0115	0	0.033	-0.17486	0.0545	0.174849	0.076	1.22371	0.0975	1.57324
0.012	-0.524613	0.0335	-0.17486	0.055	0.174849	0.0765	0.874134	0.098	1.57324
0.0125	0.699329	0.034	0.174849	0.0555	0	0.077	1.22371	0.0985	1.57324
0.013	0	0.0345	0	0.056	0	0.0775	1.04893	0.099	1.39848
0.0135	-0.349731	0.035	0	0.0565	0.174849	0.078	1.04893	0.0995	1.57324

Gauge34_6 Time msec	Gauge34_6 Stress MPa	Gauge34_6 Time msec	Gauge34_6 Stress MPa	Gauge34_6 Time msec	Gauge34_6 Stress MPa	Gauge34_6 Time msec	Gauge34_6 Stress MPa	Gauge34_6 Time msec	Gauge34_6 Stress MPa
0.1	1.39848	0.1215	0	0.143	1.04893	0.1645	0.699329	0.186	2.79626
0.1005	1.57324	0.122	0	0.1435	1.04893	0.165	1.04893	0.1865	2.97093
0.101	1.57324	0.1225	0	0.144	1.04893	0.1655	1.22371	0.187	3.32025
0.1015	1.57324	0.123	0.174849	0.1445	1.22371	0.166	1.39848	0.1875	3.84413
0.102	1.39848	0.1235	0	0.145	1.57324	0.1665	1.39848	0.188	4.36792
0.1025	1.57324	0.124	0	0.1455	1.39848	0.167	1.39848	0.1885	4.89161
0.103	1.74799	0.1245	0	0.146	1.92273	0.1675	1.74799	0.189	5.93869
0.1035	1.74799	0.125	0.174849	0.1465	1.57324	0.168	1.57324	0.1895	6.98537
0.104	1.57324	0.1255	0.174849	0.147	1.92273	0.1685	1.57324	0.19	7.68294
0.1045	1.39848	0.126	0	0.1475	2.09746	0.169	1.74799	0.1905	7.8573
0.105	1.57324	0.1265	0	0.148	1.92273	0.1695	1.57324	0.191	7.68294
0.1055	1.74799	0.127	0.174849	0.1485	1.92273	0.17	1.92273	0.1915	6.98537
0.106	1.39848	0.1275	0	0.149	2.09746	0.1705	2.09746	0.192	5.93869
0.1065	1.57324	0.128	0.174849	0.1495	2.09746	0.171	1.74799	0.1925	4.89161
0.107	1.39848	0.1285	0	0.15	2.09746	0.1715	1.74799	0.193	3.66951
0.1075	1.39848	0.129	0.174849	0.1505	2.09746	0.172	2.09746	0.1935	2.27218
0.108	1.39848	0.1295	0.174849	0.151	1.92273	0.1725	1.74799	0.194	1.22371
0.1085	1.39848	0.13	0.349687	0.1515	1.92273	0.173	1.57324	0.1945	0.699329
0.109	1.57324	0.1305	0.349687	0.152	1.74799	0.1735	1.57324	0.195	-0.699506
0.1095	1.74799	0.131	0.349687	0.1525	1.57324	0.174	1.74799	0.1955	-1.74909
0.11	1.57324	0.1315	0.349687	0.153	1.22371	0.1745	1.74799	0.196	-2.97412
0.1105	1.22371	0.132	0.349687	0.1535	1.22371	0.175	1.57324	0.1965	-3.67437
0.111	1.39848	0.1325	0.349687	0.154	1.22371	0.1755	1.57324	0.197	-4.72508
0.1115	1.74799	0.133	0.349687	0.1545	0.699329	0.176	2.44688	0.1975	-5.77619
0.112	1.57324	0.1335	0.699329	0.155	0.874134	0.1765	1.74799	0.198	-6.47715
0.1125	1.74799	0.134	0.349687	0.1555	0.524514	0.177	1.39848	0.1985	-7.17828
0.113	1.74799	0.1345	0.349687	0.156	0.349687	0.1775	1.74799	0.199	-7.87959
0.1135	1.74799	0.135	0.349687	0.1565	0.349687	0.178	1.39848	0.1995	-8.58108
0.114	1.39848	0.1355	0.699329	0.157	0.524514	0.1785	1.57324	0.2	-9.10731
0.1145	1.22371	0.136	0.524514	0.1575	0.174849	0.179	1.74799	0.2005	-9.63364
0.115	1.39848	0.1365	0.524514	0.158	0.524514	0.1795	1.57324	0.201	-9.98458
0.1155	1.22371	0.137	0.524514	0.1585	0.349687	0.18	1.57324	0.2015	-10.68666
0.116	0.874134	0.1375	0.874134	0.159	0.174849	0.1805	1.92273	0.202	-11.2132
0.1165	0.874134	0.138	0.699329	0.1595	0.174849	0.181	1.92273	0.2025	-11.5644
0.117	0.524514	0.1385	0.699329	0.16	0.174849	0.1815	1.92273	0.203	-11.74
0.1175	0.699329	0.139	0.524514	0.1605	0.174849	0.182	2.27218	0.2035	-11.9156
0.118	0.349687	0.1395	0.699329	0.161	0.174849	0.1825	2.09746	0.204	-12.2668
0.1185	0.174849	0.14	0.874134	0.1615	0.349687	0.183	2.09746	0.2045	-12.4424
0.119	0.174849	0.1405	0.874134	0.162	0.349687	0.1835	2.09746	0.205	-12.7937
0.1195	0.174849	0.141	1.04893	0.1625	0.349687	0.184	2.09746	0.2055	-13.1145
0.12	0.174849	0.1415	0.874134	0.163	0.699329	0.1845	2.44688	0.206	-13.4964
0.1205	0.174849	0.142	0.874134	0.1635	0.524514	0.185	2.44688	0.2065	-13.8478
0.121	0.174849	0.1425	0.874134	0.164	0.874134	0.1855	2.62158	0.207	-13.8478

Gauge34_6 Time msec	Gauge34_6 Stress MPa	Gauge34_6 Time msec	Gauge34_6 Stress MPa	Gauge34_6 Time msec	Gauge34_6 Stress MPa
0.2075	-14.1993	0.229	-22.4715	0.2505	-6.47715
0.208	-14.1993	0.2295	-22.4715	0.251	-6.82769
0.2085	-14.3751	0.23	-22.6478	0.2515	-7.00298
0.209	-14.7266	0.2305	-22.6478	0.252	-6.82769
0.2095	-14.7266	0.231	-21.5904	0.2525	-6.82769
0.21	-15.254	0.2315	-21.4142	0.253	-6.65242
0.2105	-15.7615	0.232	-21.0618	0.2535	-6.65242
0.211	-15.9573	0.2325	-20.7095	0.254	-6.47715
0.2115	-16.1332	0.233	-20.7095	0.2545	-6.47715
0.212	-16.3091	0.2335	-20.3572	0.255	-6.65242
0.2125	-16.6608	0.234	-20.3572	0.2555	-6.30189
0.213	-16.6608	0.2345	-20.0049	0.256	-6.65242
0.2135	-17.0127	0.235	-20.1811	0.2565	-6.30189
0.214	-17.3645	0.2355	-20.5333	0.257	-6.65242
0.2145	-17.5405	0.236	-20.7095	0.2575	-6.30189
0.215	-17.8924	0.2365	-20.5333	0.258	-6.65242
0.2155	-18.0684	0.237	-20.1811	0.2585	-6.47715
0.216	-18.2444	0.2375	-20.3572	0.259	-6.47715
0.2165	-18.5964	0.238	-20.3572	0.2595	-6.30189
0.217	-18.7724	0.2385	-20.0049	0.26	-6.12665
0.2175	-19.3006	0.239	-20.3572	0.2605	-5.95141
0.218	-19.4767	0.2395	-20.0049	0.261	-6.12665
0.2185	-19.6527	0.24	-20.0049	0.2615	-5.95141
0.219	-19.6527	0.2405	-20.3572	0.262	-5.95141
0.2195	-19.8288	0.241	-20.7095	0.2625	-5.77619
0.22	-19.8288	0.2415	-20.7095	0.263	-5.77619
0.2205	-19.8288	0.242	-20.7095	0.2635	-5.95141
0.221	-19.6527	0.2425	-20.8856	0.264	-5.95141
0.2215	-19.8288	0.243	-21.0618	0.2645	-5.77619
0.222	-20.0049	0.2435	-20.7095	0.265	-5.77619
0.2225	-20.1811	0.244	-20.7095	0.2655	-5.95141
0.223	-20.7095	0.2445	-20.3572	0.266	-5.95141
0.2235	-20.8856	0.245	-20.0049	0.2665	-5.95141
0.224	-20.8856	0.2455	-20.1811	0.267	-5.95141
0.2245	-21.0618	0.246	-20.3572	0.2675	-5.95141
0.225	-20.7095	0.2465	-20.5333	0.268	-5.95141
0.2255	-21.0618	0.247	-20.0049	0.2685	-5.95141
0.226	-18.2444	0.2475	-19.6527	0.269	-5.95141
0.2265	-27.4112	0.248	-19.8288	0.2695	-5.95141
0.227	-26.5285	0.2485	-12.2668	0.27	-5.60098
0.2275	-25.1167	0.249	-5.07541	0.2705	-5.60098
0.228	-24.2347	0.2495	-6.30189	0.271	-5.77619
0.2285	-23.1767	0.25	-6.30189	0.2715	-5.60098

Gauge35_1 Time msec	Gauge35_1 Stress MPa	Gauge35_1 Time msec	Gauge35_1 Stress MPa	Gauge35_2 Time msec	Gauge35_2 Stress MPa	Gauge35_2 Time msec	Gauge35_2 Stress MPa	Gauge35_2 Time msec	Gauge35_2 Stress MPa
-0.0075	0	0.014	-25.3894	0.0635	0	0.065	4.90084	0.1065	-1.92769
-0.007	0	0.0145	-33.8986	0.064	0.175179	0.0855	4.72596	0.107	-0.876059
-0.0065	8.41709	0.015	-8.44011	0.0645	0.175179	0.086	4.02632	0.1075	-0.350391
-0.006	0	0.0155	-25.3894	0.065	0.175179	0.0865	2.10142	0.108	0.175179
-0.0055	0	0.016	-8.44011	0.0655	0.175179	0.087	-0.17519	0.1085	0.700649
-0.005	8.41709	0.0165	-8.44011	0.066	0	0.0875	-1.75239	0.109	1.05091
-0.0045	8.41709	0.017	-16.9032	0.0665	0.175179	0.088	-2.80436	0.1095	1.57621
-0.004	8.41709	0.0175	-25.3894	0.067	0	0.0885	-3.5813	0.11	1.75129
-0.0035	0	0.018	-33.8986	0.0675	0.175179	0.089	-4.03216	0.1105	1.75129
-0.003	-8.44011	0.0185	-33.8986	0.068	0.175179	0.0895	-4.734	0.111	2.10142
-0.0025	-8.44011	0.019	8.41709	0.0685	0.175179	0.09	-5.61154	0.1115	2.27646
-0.002	8.41709	0.0195	-8.44011	0.069	0.175179	0.0905	-6.31378	0.112	2.10142
-0.0015	0	0.02	-8.44011	0.0695	0.175179	0.091	-7.0162	0.1125	2.10142
-0.001	0	0.0205	0	0.07	0.350347	0.0915	-7.89446	0.113	1.92636
-0.0005	8.41709	0.021	-8.44011	0.0705	0.175179	0.092	-8.94674	0.1135	1.75129
0	8.41709	0.0215	-16.9032	0.071	0.350347	0.0925	-9.30026	0.114	1.75129
0.0005	226.977			0.0715	0	0.093	-9.82762	0.1145	1.57621
0.001	332.958			0.072	0.350347	0.0935	-10.1792	0.115	1.22602
0.0015	203.521			0.0725	0.175179	0.094	-11.2344	0.1155	1.40112
0.002	99.4858			0.073	0.175179	0.0945	-11.5662	0.116	1.40112
0.0025	50.1573			0.0735	0	0.095	-12.2899	0.1165	1.57621
0.003	16.8112			0.074	0.175179	0.0955	-12.6419	0.117	1.57621
0.0035	8.41709			0.0745	0.350347	0.096	-12.9938	0.1175	1.40112
0.004	-25.3894			0.075	0.175179	0.0965	-12.9938	0.118	1.05091
0.0045	-42.4308			0.0755	0	0.097	-12.9938	0.1185	0.700649
0.005	-42.4308			0.076	-0.17519	0.0975	-12.4659	0.119	0.175179
0.0055	-16.9032			0.0765	0	0.098	-12.2899	0.1195	-0.17519
0.006	-16.9032			0.077	-0.17519	0.0985	-12.114	0.12	-1.0513
0.0065	-50.986			0.0775	-0.17519	0.099	-11.5862	0.1205	-1.75239
0.007	-25.3894			0.078	-0.17519	0.0995	-11.7621	0.121	-2.45366
0.0075	8.41709			0.0785	0	0.1	-11.4103	0.1215	-3.1551
0.008	8.41709			0.079	0.175179	0.1005	-10.7068	0.122	-3.50589
0.0085	-129.019			0.0795	-0.17519	0.101	-10.3551	0.1225	-3.85672
0.009	8.41709			0.08	-0.17519	0.1015	-9.65182	0.123	-4.2076
0.0095	0			0.0805	0	0.102	-9.1245	0.1235	-4.38305
0.01	-8.44011			0.081	0	0.1025	-8.42155	0.124	-4.90948
0.0105	25.1822			0.0815	-0.17519	0.103	-7.71879	0.1245	-4.90948
0.011	-25.3894			0.082	0.175179	0.1035	-6.84058	0.125	-4.734
0.0115	-16.9032			0.0825	1.22602	0.104	-5.78709	0.1255	-4.90948
0.012	-33.8986			0.083	1.22602	0.1045	-5.08498	0.126	-5.26049
0.0125	-16.9032			0.0835	2.27646	0.105	-4.2076	0.1265	-4.03216
0.013	-16.9032			0.084	3.50148	0.1055	-3.50589	0.127	-3.6813
0.0135	-25.3894			0.0845	4.37616	0.106	-2.62901	0.1275	-3.85672

Gauge35_2 Time msec	Gauge35_2 Stress MPa	Gauge35_2 Time msec	Gauge35_2 Stress MPa	Gauge35_2 Time msec	Gauge35_2 Stress MPa	Gauge35_2 Time msec	Gauge35_2 Stress MPa	Gauge35_2 Time msec	Gauge35_2 Stress MPa
0.126	-4.03216	0.1495	1.05091	0.171	0.350347	0.1925	0.875784	0.214	3.15153
0.1285	-3.85672	0.15	0.875784	0.1715	0.175179	0.193	1.05091	0.2145	3.15153
0.129	-3.85672	0.1505	1.05091	0.172	0.350347	0.1935	1.22602	0.215	3.32651
0.1295	-3.6813	0.151	0.700649	0.1725	0	0.194	1.40112	0.2155	3.76444
0.13	-3.6813	0.1515	0.525503	0.173	0.175179	0.1945	1.40112	0.216	3.50148
0.1305	-3.33049	0.152	0.525503	0.1735	0	0.195	1.57621	0.2165	3.15153
0.131	-3.1551	0.1525	0.875784	0.174	0.175179	0.1955	1.57621	0.217	3.65139
0.1315	-2.97973	0.153	0.525503	0.1745	0	0.196	1.40112	0.2175	4.37616
0.132	-2.80436	0.1535	0.525503	0.175	0.350347	0.1965	1.40112	0.218	4.20125
0.1325	-2.45366	0.154	0.525503	0.1755	0.700649	0.197	1.05091	0.2185	4.20125
0.133	-2.27633	0.1545	0.700649	0.176	1.05091	0.1975	0.875784	0.219	4.20125
0.1335	-2.10301	0.155	0.700649	0.1765	1.05091	0.198	0.875784	0.2195	4.02632
0.134	-2.10301	0.1555	0.875784	0.177	1.40112	0.1985	0.700649	0.22	4.02632
0.1345	-1.75239	0.156	1.22602	0.1775	1.57621	0.199	0.525503	0.2205	3.85139
0.135	-1.40183	0.1565	1.05091	0.178	1.75129	0.1995	0.350347	0.221	3.67644
0.1355	-1.22656	0.157	0.875784	0.1785	1.75129	0.2	0.350347	0.2215	3.32651
0.136	-1.0513	0.1575	0.875784	0.179	2.10142	0.2005	0.175179	0.222	3.15153
0.1365	-1.22656	0.158	1.05091	0.1795	2.10142	0.201	0	0.2225	2.80154
0.137	-0.525603	0.1585	1.05091	0.18	2.27646	0.2015	0	0.223	2.62652
0.1375	-0.17519	0.159	1.40112	0.1805	2.27646	0.202	0	0.2235	2.62652
0.138	-0.350391	0.1595	1.40112	0.181	2.27646	0.2025	0	0.224	2.27646
0.1385	-0.17519	0.16	1.57621	0.1815	2.10142	0.203	0	0.2245	1.92636
0.139	0	0.1605	1.75129	0.182	2.27646	0.2035	0	0.225	1.75129
0.1395	0.175179	0.161	1.75129	0.1825	1.92636	0.204	-0.17519	0.2255	1.40112
0.14	0.350347	0.1615	1.75129	0.183	1.92636	0.2045	0.175179	0.226	1.22602
0.1405	0.525503	0.162	1.92636	0.1835	1.40112	0.205	0.175179	0.2265	0.700649
0.141	0.700649	0.1625	2.10142	0.184	1.05091	0.2055	0	0.227	0.525503
0.1415	0.700649	0.163	2.10142	0.1845	0.525503	0.206	0.175179	0.2275	0.350347
0.142	0.700649	0.1635	2.27646	0.185	0	0.2065	0	0.228	0
0.1425	0.700649	0.164	2.27646	0.1855	-0.525603	0.207	0.175179	0.2285	-0.17519
0.143	1.05091	0.1645	2.4515	0.186	-0.350391	0.2075	0.525503	0.229	-0.350391
0.1435	1.05091	0.165	2.4515	0.1865	-0.525603	0.208	0.875784	0.2295	-0.525603
0.144	1.40112	0.1655	2.4515	0.187	-0.700825	0.2085	1.05091	0.23	-0.876059
0.1445	1.57621	0.166	2.4515	0.1875	-0.876059	0.209	1.22602	0.2305	-0.876059
0.145	1.75129	0.1665	2.27646	0.188	-1.0513	0.2095	1.40112	0.231	-1.0513
0.1455	1.75129	0.167	2.27646	0.1885	-1.22656	0.21	1.57621	0.2315	-1.0513
0.146	1.75129	0.1675	2.10142	0.189	-1.0513	0.2105	1.92636	0.232	-1.40163
0.1465	1.57621	0.168	1.75129	0.1895	-0.876059	0.211	1.92636	0.2325	-1.57711
0.147	1.75129	0.1685	1.57621	0.19	-0.876059	0.2115	2.27646	0.233	-1.57711
0.1475	2.10142	0.169	1.57621	0.1905	-0.700825	0.212	2.27646		
0.148	1.57621	0.1695	1.22602	0.191	-0.525603	0.2125	2.62652		
0.1485	1.57621	0.17	1.05091	0.1915	0	0.213	2.80154		
0.149	1.57621	0.1705	0.875784	0.192	0.350347	0.2135	2.80154		

Gauge35_J Time msec	Gauge35_J Stress MPa	Gauge35_J Time msec	Gauge35_J Stress MPa	Gauge35_J Time msec	Gauge35_J Stress MPa	Gauge35_J Time msec	Gauge35_J Stress MPa	Gauge35_J Time msec	Gauge35_J Stress MPa
0.0395	0.348375	0.061	2.4377	0.0825	4.69936	0.104	-6.27824	0.1255	-4.00946
0.04	0.348375	0.0615	0.174193	0.083	4.52545	0.1045	-5.57996	0.126	-3.83502
0.0405	0.348375	0.062	0	0.0835	4.35153	0.105	-5.40542	0.1265	-4.00946
0.041	0.348375	0.0625	0	0.084	3.30779	0.1055	-5.23088	0.127	-4.53286
0.0415	0.348375	0.063	0.174193	0.0845	2.4377	0.106	-5.05636	0.1275	-4.53286
0.042	0.348375	0.0635	0	0.085	1.74143	0.1065	-5.05636	0.128	-4.88185
0.0425	0.348375	0.064	0.174193	0.0855	0.696705	0.107	-4.35838	0.1285	-5.05636
0.043	0.348375	0.0645	0	0.086	-0.174204	0.1075	-4.18392	0.129	-5.23088
0.0435	0.348375	0.065	0	0.0865	-0.871128	0.108	-3.83502	0.1295	-5.40542
0.044	0.348375	0.0655	0	0.087	-1.04539	0.1085	-3.83502	0.13	-5.40542
0.0445	0	0.066	0	0.0875	-0.871128	0.109	-3.66058	0.1305	-5.57996
0.045	0.348375	0.0665	0.348375	0.088	-1.21966	0.1095	-3.48616	0.131	-5.57996
0.0455	0.174193	0.067	0	0.0885	-1.39394	0.11	-3.13735	0.1315	-5.75451
0.046	0.348375	0.0675	0	0.089	-1.91684	0.1105	-2.96296	0.132	-5.92908
0.0465	0.348375	0.068	0	0.0895	-3.31175	0.111	-2.61421	0.1325	-5.92908
0.047	0.348375	0.0685	0.174193	0.09	-4.35838	0.1115	-2.61421	0.133	-5.92908
0.0475	0.348375	0.069	0.174193	0.0905	-5.23088	0.112	-2.2655	0.1335	-6.10366
0.048	-0.174204	0.0695	0	0.091	-6.10366	0.1125	-2.2655	0.134	-5.92908
0.0485	0.348375	0.07	0	0.0915	-7.326	0.113	-2.09117	0.1345	-5.92908
0.049	0.174193	0.0705	0	0.092	-8.02472	0.1135	-1.56823	0.135	-5.92908
0.0495	0.174193	0.071	0.174193	0.0925	-8.89838	0.114	-1.74253	0.1355	-5.75451
0.05	0	0.0715	-0.174204	0.093	-9.24791	0.1145	-1.74253	0.136	-5.57996
0.0505	-0.174204	0.072	0	0.0935	-9.07314	0.115	-1.91684	0.1365	-5.92908
0.051	0	0.0725	0	0.094	-9.94712	0.1155	-1.04539	0.137	-5.75451
0.0515	0	0.073	0	0.0945	-10.1219	0.116	-1.39394	0.1375	-5.75451
0.052	-0.174204	0.0735	0	0.095	-9.94712	0.1165	-1.39394	0.138	-5.92908
0.0525	-0.174204	0.074	0	0.0955	-10.2968	0.117	-1.21966	0.1385	-5.75451
0.053	0	0.0745	-0.174204	0.096	-10.1219	0.1175	-1.39394	0.139	-5.75451
0.0535	0	0.075	0	0.0965	-10.4716	0.118	-1.56823	0.1395	-5.57996
0.054	0	0.0755	0	0.097	-9.94712	0.1185	-1.74253	0.14	-5.57996
0.0545	0	0.076	0.174193	0.0975	-9.94712	0.119	-1.74253	0.1405	-5.40542
0.055	0.174193	0.0765	0.174193	0.098	-10.1219	0.1195	-2.2655	0.141	-5.23088
0.0555	0	0.077	0	0.0985	-10.2968	0.12	-2.09117	0.1415	-5.23088
0.056	0.174193	0.0775	0	0.099	-10.4716	0.1205	-2.43985	0.142	-5.05636
0.0565	0	0.078	0.174193	0.0995	-9.59749	0.121	-2.43985	0.1425	-4.88185
0.057	0.174193	0.0785	0.174193	0.1	-9.59749	0.1215	-2.61421	0.143	-4.53286
0.0575	0	0.079	0.348375	0.1005	-9.59749	0.122	-2.78858	0.1435	-4.35838
0.058	0.174193	0.0795	0.522545	0.101	-9.59749	0.1225	-2.78858	0.144	-4.00946
0.0585	0	0.08	0.696705	0.1015	-9.07314	0.123	-2.96296	0.1445	-3.66058
0.059	0.174193	0.0805	1.39324	0.102	-8.19943	0.1235	-3.13735	0.145	-3.48616
0.0595	0.174193	0.081	1.74143	0.1025	-7.67534	0.124	-3.31175	0.1455	-3.31175
0.06	0	0.0815	2.78577	0.103	-7.15135	0.1245	-3.48616	0.146	-2.78858
0.0605	0.174193	0.082	3.65575	0.1035	-6.80207	0.125	-3.31175	0.1465	-2.43985

Gauge35_J Time msec	Gauge35_J Stress MPa	Gauge35_J Time msec	Gauge35_J Stress MPa	Gauge35_J Time msec	Gauge35_J Stress MPa	Gauge35_J Time msec	Gauge35_J Stress MPa	Gauge35_4 Time msec	Gauge35_4 Stress MPa
0.147	-2.2655	0.1685	-1.56823	0.19	1.91552	0.2115	-3.48616	0.077	0
0.1475	-1.91684	0.169	-1.56823	0.1905	1.74143	0.212	-3.83502	0.0775	0
0.148	-1.74253	0.1695	-1.56823	0.191	1.74143	0.2125	-4.00946	0.078	0
0.1485	-1.91684	0.17	-1.39394	0.1915	1.74143	0.213	-3.83502	0.0785	0
0.149	-1.74253	0.1705	-1.39394	0.192	1.74143	0.2135	-3.83502	0.079	0.178205
0.1495	-1.74253	0.171	-1.04539	0.1925	1.56734	0.214	-3.83502	0.0795	0.178205
0.15	-1.74253	0.1715	-1.39394	0.193	1.39324	0.2145	-4.00946	0.08	0
0.1505	-1.56823	0.172	-1.21966	0.1935	1.39324	0.215	-3.31175	0.0805	0
0.151	-1.56823	0.1725	-1.39394	0.194	1.39324	0.2155	-3.48616	0.081	0
0.1515	-1.74253	0.173	-1.39394	0.1945	1.21912	0.216	-3.66058	0.0815	0
0.152	-1.39394	0.1735	-1.39394	0.195	1.21912	0.2165	-3.13735	0.082	0
0.1525	-1.56823	0.174	-1.39394	0.1955	1.04499	0.217	-2.96296	0.0825	0
0.153	-1.39394	0.1745	-1.39394	0.196	1.04499	0.2175	-2.61421	0.083	0
0.1535	-1.21966	0.175	-1.56823	0.1965	0.870854	0.218	-2.2655	0.0835	0
0.154	-1.21966	0.1755	-1.56823	0.197	1.04499	0.2185	-2.09117	0.084	0
0.1545	-1.21966	0.176	-1.56823	0.1975	0.696705	0.219	-1.56823	0.0845	0
0.155	-1.04539	0.1765	-1.74253	0.198	0.522545	0.2195	-2.61421	0.085	0
0.1555	-1.04539	0.177	-1.74253	0.1985	0.348375	0.22	-1.74253	0.0855	-0.178216
0.156	-1.04539	0.1775	-1.56823	0.199	0.348375	0.2205	-1.21966	0.086	-0.178216
0.1565	-1.04539	0.178	-1.74253	0.1995	-0.174204	0.221	-0.871128	0.0865	0
0.157	-1.04539	0.1785	-1.56823	0.2	0	0.2215	-0.871128	0.087	0
0.1575	-1.21966	0.179	-1.39394	0.2005	-0.174204	0.222	-0.696881	0.0875	0
0.158	-1.21966	0.1795	-1.56823	0.201	-0.348418	0.2225	-0.522644	0.088	0
0.1585	-1.21966	0.18	-1.39394	0.2015	-0.522644	0.223	-0.174204	0.0885	0
0.159	-1.21966	0.1805	-1.21966	0.202	-0.696881	0.2235	-0.348418	0.089	0
0.1595	-1.56823	0.181	-1.04539	0.2025	-0.871128	0.224	0	0.0895	0
0.16	-1.39394	0.1815	-0.871128	0.203	-0.871128	0.2245	0.174193	0.09	0.178205
0.1605	-1.56823	0.182	-0.696881	0.2035	-1.21966	0.225	0.522545	0.0905	0
0.161	-1.39394	0.1825	-0.348418	0.204	-1.39394	0.2255	0.696705	0.091	0.178205
0.1615	-1.56823	0.183	-0.174204	0.2045	-1.56823	0.226	0.870854	0.0915	0
0.162	-1.56823	0.1835	0.348375	0.205	-1.74253	0.2265	0.348375	0.092	0
0.1625	-1.56823	0.184	0.174193	0.2055	-1.91684	0.227	1.39324	0.0925	0
0.163	-1.56823	0.1845	0.522545	0.206	-1.91684	0.2275	1.56734	0.093	0
0.1635	-1.56823	0.185	0.696705	0.2065	-2.2655	0.228	1.56734	0.0935	0.356399
0.164	-1.56823	0.1855	1.04499	0.207	-2.43985	0.2285	1.39324	0.094	0
0.1645	-1.39394	0.186	1.21912	0.2075	-2.43985	0.229	1.39324	0.0945	0
0.165	-1.56823	0.1865	1.21912	0.208	-2.61421	0.2295	1.56734	0.095	0
0.1655	-1.39394	0.187	1.39324	0.2085	-2.61421	0.23	1.39324	0.0955	0
0.166	-1.74253	0.1875	1.74143	0.209	-2.96296	0.2305	1.21912	0.096	0
0.1665	-1.74253	0.188	1.74143	0.2095	-3.31175	0.231	0.870854	0.0965	0
0.167	-1.74253	0.1885	1.91552	0.21	-3.48616	0.2315	0.522545	0.097	0
0.1675	-1.74253	0.189	2.08959	0.2105	-3.48616	0.232	0.174193	0.0975	-0.534682
0.168	-1.39394	0.1895	1.74143	0.211	-3.83502	0.2325	-0.522644	0.098	-0.178216

Gauge35_4 Time msec	Gauge35_4 Stress MPa	Gauge35_4 Time msec	Gauge35_4 Stress MPa	Gauge35_4 Time msec	Gauge35_4 Stress MPa	Gauge35_4 Time msec	Gauge35_4 Stress MPa	Gauge35_4 Time msec	Gauge35_4 Stress MPa
0.0985	0	0.12	0.712752	0.1415	1.2472	0.163	-0.178216	0.1845	4.09587
0.099	-0.178216	0.1205	0.356399	0.142	0.712752	0.1635	-0.178216	0.185	2.84993
0.0995	-0.534682	0.121	0.712752	0.1425	0.712752	0.164	-0.178216	0.1855	1.42533
0.1	-0.891193	0.1215	0.712752	0.143	0.178205	0.1645	-0.178216	0.186	-0.712932
0.1005	0	0.122	0.890912	0.1435	-0.356443	0.165	-0.178216	0.1865	-1.78267
0.101	0	0.1225	0.890912	0.144	-0.891193	0.1655	-0.356443	0.187	-3.0312
0.1015	0	0.123	0.712752	0.1445	-1.06947	0.166	-0.178216	0.1875	-3.56645
0.102	-0.178216	0.1235	0.712752	0.145	-1.42604	0.1665	-0.356443	0.188	-4.10181
0.1025	0	0.124	0.712752	0.1455	-1.78267	0.167	-0.356443	0.1885	-4.45877
0.103	0	0.1245	0.712752	0.146	-1.96099	0.1675	-0.534682	0.189	-4.99429
0.1035	0	0.125	1.06906	0.1465	-2.31768	0.168	-0.534682	0.1895	-4.81577
0.104	0.178205	0.1255	0.356399	0.147	-1.96099	0.1685	-0.712932	0.19	-5.17282
0.1045	0.178205	0.126	-0.891193	0.1475	-2.31768	0.169	-0.891193	0.1905	-4.99429
0.105	0.178205	0.1265	0.356399	0.148	-1.78267	0.1695	-0.712932	0.191	-4.81577
0.1055	0.178205	0.127	0.712752	0.1485	-1.60435	0.17	-0.891193	0.1915	-4.28028
0.106	0.178205	0.1275	0.178205	0.149	-1.24775	0.1705	-0.891193	0.192	-3.74489
0.1065	0	0.128	0	0.1495	-1.06947	0.171	-0.891193	0.1925	-3.38803
0.107	0	0.1285	-0.178216	0.15	-0.712932	0.1715	-0.712932	0.193	-2.49605
0.1075	-0.178216	0.129	-0.178216	0.1505	-0.534682	0.172	-0.712932	0.1935	-1.78267
0.108	-0.178216	0.1295	-0.356443	0.151	0	0.1725	-0.534682	0.194	-1.60435
0.1085	0	0.13	-0.178216	0.1515	0	0.173	-0.356443	0.1945	-1.24775
0.109	-0.178216	0.1305	-0.712932	0.152	0.890912	0.1735	-0.356443	0.195	-0.891193
0.1095	-0.178216	0.131	-0.534682	0.1525	1.06906	0.174	-0.356443	0.1955	-1.06947
0.11	-0.534682	0.1315	-0.891193	0.153	1.42533	0.1745	-0.356443	0.196	-1.06947
0.1105	-0.534682	0.132	-1.24775	0.1535	1.42533	0.175	-0.178216	0.1965	-0.891193
0.111	-0.534682	0.1325	-0.534682	0.154	1.2472	0.1755	0.356399	0.197	-1.24775
0.1115	-0.534682	0.133	-1.06947	0.1545	1.42533	0.176	0.534581	0.1975	-1.24775
0.112	-0.891193	0.1335	0.890912	0.155	1.60344	0.1765	0.712752	0.198	-1.24775
0.1125	-0.712932	0.134	-1.24775	0.1555	1.42533	0.177	1.06906	0.1985	-1.42604
0.113	-0.712932	0.1345	-0.534682	0.156	1.2472	0.1775	1.2472	0.199	-1.60435
0.1135	-0.712932	0.135	-0.534682	0.1565	1.2472	0.178	1.60344	0.1995	-1.78267
0.114	-0.891193	0.1355	0	0.157	1.2472	0.1785	1.60344	0.2	-1.96099
0.1145	-1.06947	0.136	0.178205	0.1575	0.712752	0.179	1.95964	0.2005	-1.96099
0.115	-0.891193	0.1365	0.712752	0.158	0.712752	0.1795	2.13772	0.201	-1.96099
0.1155	-0.891193	0.137	1.06906	0.1585	0.356399	0.18	1.95964	0.2015	-1.96099
0.116	-0.712932	0.1375	1.06906	0.159	0.178205	0.1805	2.31579	0.202	-1.78267
0.1165	-0.712932	0.138	1.2472	0.1595	0	0.181	2.31579	0.2025	-1.42604
0.117	-0.712932	0.1385	1.60344	0.16	-0.178216	0.1815	2.49385	0.203	-1.42604
0.1175	-0.534682	0.139	1.78154	0.1605	-0.356443	0.182	2.6719	0.2035	-1.24775
0.118	-0.534682	0.1395	1.78154	0.161	-0.534682	0.1825	3.20597	0.204	-0.891193
0.1185	-0.178216	0.14	1.78154	0.1615	-0.356443	0.183	3.73995	0.2045	-0.712932
0.119	0	0.1405	1.60344	0.162	-0.356443	0.1835	4.62968	0.205	-0.356443
0.1195	0.178205	0.141	1.60344	0.1625	-0.356443	0.184	4.80759	0.2055	-0.356443

Gauge35_4 Time msec	Gauge35_4 Stress MPa	Gauge35_4 Time msec	Gauge35_4 Stress MPa	Gauge35_5 Time msec	Gauge35_5 Stress MPa	Gauge35_5 Time msec	Gauge35_5 Stress MPa	Gauge35_5 Time msec	Gauge35_5 Stress MPa
0.206	-0.356443	0.2275	-2.8528	0.0605	0.177864	0.082	0	0.1035	-1.42331
0.2065	0	0.228	-2.8528	0.061	0.355716	0.0825	-0.355761	0.104	-1.60128
0.207	0.178205	0.2285	-2.8528	0.0615	0.355716	0.083	-0.177875	0.1045	-1.77925
0.2075	0.356399	0.229	-2.49605	0.062	0.355716	0.0835	-0.177875	0.105	-1.77925
0.208	0.534581	0.2295	-2.49605	0.0625	0.355716	0.084	-0.355761	0.1055	-1.77925
0.2085	1.06906	0.23	-2.13933	0.063	0.355716	0.0845	-0.355761	0.106	-1.42331
0.209	1.06906	0.2305	-2.13933	0.0635	0.355716	0.085	-0.355761	0.1065	-1.24536
0.2095	1.2472	0.231	-1.96099	0.064	0.177864	0.0855	-0.355761	0.107	-1.06742
0.21	1.2472	0.2315	-1.78267	0.0645	0.355716	0.086	-0.533658	0.1075	-0.889486
0.2105	1.2472	0.232	-1.60435	0.065	0.177864	0.0865	-0.533658	0.108	-0.177875
0.211	1.2472	0.2325	-1.42604	0.0655	0.355716	0.087	-1.24536	0.1085	-0.177875
0.2115	1.42533	0.233	-1.60435	0.066	0	0.0875	-0.533658	0.109	0.355716
0.212	1.42533	0.2335	-1.42604	0.0665	0	0.088	-0.533658	0.1095	0.711367
0.2125	1.2472	0.234	-1.06947	0.067	0.355716	0.0885	-0.711566	0.11	0.889206
0.213	1.2472	0.2345	-1.06947	0.0675	0.355716	0.089	-0.533658	0.1105	1.24481
0.2135	1.06906	0.235	-0.891193	0.068	0.355716	0.0895	-0.711566	0.111	1.42259
0.214	0.712752	0.2355	-0.712932	0.0685	0.177864	0.09	-0.533658	0.1115	1.42259
0.2145	0.712752	0.236	-0.178216	0.069	0.177864	0.0905	-0.889486	0.112	1.42259
0.215	0.890912	0.2365	-0.178216	0.0695	0.177864	0.091	-0.533658	0.1125	1.24481
0.2155	0.534581	0.237	0.178205	0.07	0.177864	0.0915	-1.24536	0.113	1.06701
0.216	0	0.2375	0.178205	0.0705	0	0.092	-0.889486	0.1135	0.889206
0.2165	-0.712932	0.238	0.534581	0.071	0	0.0925	-0.533658	0.114	0.889206
0.217	-0.356443	0.2385	0.890912	0.0715	-0.177875	0.093	-1.24536	0.1145	0.355716
0.2175	0	0.239	1.06906	0.072	0.177864	0.0935	-0.355761	0.115	0.177864
0.218	-0.534682	0.2395	1.2472	0.0725	0.177864	0.094	-0.177875	0.1155	-0.355761
0.2185	-0.891193	0.24	1.42533	0.073	0.177864	0.0945	0	0.116	-0.711566
0.219	-1.42604	0.2405	1.42533	0.0735	0.177864	0.095	-0.533658	0.1165	-1.06742
0.2195	-1.60435	0.241	1.06906	0.074	0	0.0955	-0.177875	0.117	-1.24536
0.22	-1.78267	0.2415	1.06906	0.0745	0	0.096	0	0.1175	-1.77925
0.2205	-2.13933	0.075	0.177864	0.075	0.177864	0.0965	0.177864	0.118	-1.42331
0.221	-2.31768	0.0755	0.177864	0.0755	0.177864	0.097	0.711367	0.1185	-1.77925
0.2215	-2.67442	0.076	0.177864	0.076	0.177864	0.0975	0.355716	0.119	-1.77925
0.222	-2.49605	0.0765	1.24481	0.0765	1.24481	0.098	0.889206	0.1195	-1.77925
0.2225	-2.8528	0.077	0.533557	0.077	0.533557	0.0985	0.533557	0.12	-1.95724
0.223	-2.67442	0.0775	0.177864	0.0775	0.177864	0.099	0.533557	0.1205	-1.24536
0.2235	-2.8528	0.078	0.889206	0.078	0.889206	0.0995	0.533557	0.121	-1.06742
0.224	-2.8528	0.0785	0	0.0785	0	0.1	0.177864	0.1215	-0.711566
0.2245	-3.0312	0.079	0.177864	0.079	0.177864	0.1005	0	0.122	-0.355761
0.225	-3.0312	0.0795	0.177864	0.0795	0.177864	0.101	-0.177875	0.1225	0
0.2255	-2.67442	0.08	1.5672E-13	0.08	1.5672E-13	0.1015	-0.355761	0.123	0.177864
0.226	-2.8528	0.0805	0.177864	0.0805	0.177864	0.102	-0.711566	0.1235	0.177864
0.2265	-2.8528	0.081	0	0.081	0	0.1025	-0.889486	0.124	0.533557
0.227	-3.0312	0.0815	0	0.0815	0	0.103	-1.06742	0.1245	0.711367



Gauge35_5 Time msec	Gauge35_5 Stress MPa	Gauge35_5 Time msec	Gauge35_5 Stress MPa	Gauge35_5 Time msec	Gauge35_5 Stress MPa	Gauge35_5 Time msec	Gauge35_5 Stress MPa	Gauge35_5 Time msec	Gauge35_5 Stress MPa
0.125	0.889206	0.1465	-0.889486	0.168	0	0.1895	1.06701	0.211	-2.49127
0.1255	1.06701	0.147	-0.533658	0.1685	-0.533658	0.19	0.355716	0.2115	-2.13524
0.126	1.06701	0.1475	-1.06742	0.169	1.24481	0.1905	0.355716	0.212	-1.95724
0.1265	1.06701	0.148	-0.533658	0.1695	-0.711566	0.191	0.177864	0.2125	-1.77925
0.127	1.06701	0.1485	-0.711566	0.17	-0.533658	0.1915	0.177864	0.213	-1.42331
0.1275	0.711387	0.149	-0.533658	0.1705	-0.177875	0.192	0	0.2135	-1.24536
0.128	0.889206	0.1495	-0.533658	0.171	0	0.1925	-0.177875	0.214	-1.24536
0.1285	0.711387	0.15	0	0.1715	-0.177875	0.193	0.177864	0.2145	-1.06742
0.129	0.533557	0.1505	0.177864	0.172	-0.355761	0.1935	0.177864	0.215	-0.889486
0.1295	0.355716	0.151	0.355716	0.1725	0.355716	0.194	0.355716	0.2155	-0.889486
0.13	0.177864	0.1515	0.355716	0.173	0	0.1945	-0.177875	0.216	-0.533658
0.1305	0	0.152	0.355716	0.1735	-0.177875	0.195	-0.355761	0.2165	-0.711566
0.131	0.177864	0.1525	0.355716	0.174	-0.533658	0.1955	-0.533658	0.217	-0.533658
0.1315	-0.355761	0.153	0.177864	0.1745	-0.355761	0.196	-0.711566	0.2175	-0.711566
0.132	-0.533658	0.1535	0.177864	0.175	-0.355761	0.1965	-1.24536	0.218	-0.711566
0.1325	-0.533658	0.154	-0.177875	0.1755	-0.355761	0.197	-1.60128	0.2185	-0.889486
0.133	-0.533658	0.1545	0	0.176	-0.711566	0.1975	-1.60128	0.219	-1.06742
0.1335	-0.533658	0.155	-0.355761	0.1765	-0.355761	0.198	-1.95724	0.2195	-1.24536
0.134	-0.889486	0.1555	-0.355761	0.177	-0.355761	0.1985	-2.31324	0.22	-1.42331
0.1345	-0.889486	0.156	-0.711566	0.1775	-0.355761	0.199	-2.6693	0.2205	-1.60128
0.135	-0.889486	0.1565	-0.889486	0.178	1.24481	0.1995	-2.31324	0.221	-1.42331
0.1355	-0.889486	0.157	-1.42331	0.1785	-0.177875	0.2	-2.6693	0.2215	-1.60128
0.136	-0.533658	0.1575	-1.42331	0.179	0	0.2005	-2.6693	0.222	-1.95724
0.1365	-0.533658	0.158	-1.77925	0.1795	0	0.201	-3.20346	0.2225	-1.95724
0.137	0	0.1585	-1.77925	0.18	0.533557	0.2015	-3.38153	0.223	-1.95724
0.1375	0	0.159	0	0.1805	0.355716	0.202	-3.73772	0.2235	-2.13524
0.138	0.355716	0.1595	-1.42331	0.181	0.355716	0.2025	-3.91583	0.224	-2.13524
0.1385	0.355716	0.16	-1.06742	0.1815	0.177864	0.203	-4.09395	0.2245	-2.13524
0.139	0.533557	0.1605	-0.177875	0.182	0.177864	0.2035	-4.09395	0.225	-2.13524
0.1395	0.355716	0.161	-0.177875	0.1825	0	0.204	-4.27208	0.2255	-2.13524
0.14	0.355716	0.1615	-0.355761	0.183	0	0.2045	-3.91583	0.226	-2.31324
0.1405	0.711387	0.162	0	0.1835	0.355716	0.205	-3.73772	0.2265	-2.31324
0.141	0.533557	0.1625	0.355716	0.184	0.711387	0.2055	-3.73772	0.227	-2.6693
0.1415	0.177864	0.163	0.533557	0.1845	1.06701	0.206	-3.73772	0.2275	-2.31324
0.142	0.177864	0.1635	0.533557	0.185	1.60037	0.2065	-3.73772	0.228	-2.31324
0.1425	-0.177875	0.164	0.533557	0.1855	2.31135	0.207	-3.55962	0.2285	-2.49127
0.143	-1.60128	0.1645	0.177864	0.186	3.19983	0.2075	-3.55962	0.229	-2.31324
0.1435	-0.889486	0.165	1.42259	0.1865	3.55514	0.208	-3.73772	0.2295	-2.13524
0.144	-1.06742	0.1655	0.533557	0.187	4.08803	0.2085	-3.38153	0.23	-2.13524
0.1445	-1.24536	0.166	3.77749	0.1875	4.26563	0.209	-3.20346	0.2305	-2.13524
0.145	-1.24536	0.1665	0.177864	0.188	3.73278	0.2095	-3.20346	0.231	-2.31324
0.1455	-1.06742	0.167	-0.177875	0.1885	2.84447	0.21	-3.02539	0.2315	-2.13524
0.146	-1.60128	0.1675	-0.177875	0.189	2.13362	0.2105	-3.02539	0.232	-2.13524

Gauge35_5 Time msec	Gauge35_5 Stress MPa	Gauge35_6 Time msec	Gauge35_6 Stress MPa	Gauge35_6 Time msec	Gauge35_6 Stress MPa	Gauge35_6 Time msec	Gauge35_6 Stress MPa	Gauge35_6 Time msec	Gauge35_6 Stress MPa
0.2325	-1.95724	0.0875	0.175842	0.109	0.351674	0.1305	-0.70348	0.152	1.05489
0.233	-1.95724	0.088	0	0.1095	0	0.131	-0.70348	0.1525	0.879101
0.2335	-1.95724	0.0885	0	0.11	0.175842	0.1315	-0.70348	0.153	-0.175853
0.234	-1.77925	0.089	0	0.1105	1.93366	0.132	-0.70348	0.1535	-0.70348
0.2345	-1.95724	0.0895	0	0.111	1.40643	0.1325	-1.23121	0.154	-1.23121
		0.09	0	0.1115	0.527494	0.133	-0.879378	0.1545	-1.935
		0.0905	0.175842	0.112	0.175842	0.1335	-1.05529	0.155	-2.28696
		0.091	0	0.1125	1.05	0.134	-0.879378	0.1555	-2.63896
		0.0915	0.175842	0.113	1.40643	0.1345	-1.05529	0.156	-2.99101
		0.092	-0.175853	0.1135	3.33911	0.135	-1.58308	0.1565	-3.51917
		0.0925	-0.175853	0.114	0.175842	0.1355	-1.75903	0.157	-3.69525
		0.093	0	0.1145	2.98781	0.136	-1.75903	0.1575	-3.69525
		0.0935	0.351674	0.115	-0.175853	0.1365	-2.46296	0.158	-3.51917
		0.094	0	0.1155	0	0.137	-2.81498	0.1585	-3.34311
		0.0945	0	0.116	-0.175853	0.1375	-2.46296	0.159	-3.34311
		0.095	0	0.1165	0.175842	0.138	-2.46296	0.1595	-2.99101
		0.0955	0	0.117	0	0.1385	-2.81498	0.16	-2.63896
		0.096	0	0.1175	-0.175853	0.139	-2.63896	0.1605	-2.11097
		0.0965	0	0.118	-0.70348	0.1395	-2.63896	0.161	-1.75903
		0.097	0	0.1185	0	0.14	-2.46296	0.1615	-1.40714
		0.0975	0	0.119	-0.70348	0.1405	-2.28696	0.162	-0.527593
		0.098	0	0.1195	-0.70348	0.141	-1.935	0.1625	-0.527593
		0.0985	0.175842	0.12	-0.351718	0.1415	-1.935	0.163	0
		0.099	0	0.1205	-0.527593	0.142	-1.40714	0.1635	0
		0.0995	0	0.121	-0.351718	0.1425	-1.23121	0.164	0
		0.1	0	0.1215	-4.92808	0.143	0	0.1645	0
		0.1005	0	0.122	-0.351718	0.1435	0.351674	0.165	-0.527593
		0.101	0	0.1225	-0.70348	0.144	0.703303	0.1655	-0.879378
		0.1015	0	0.123	-0.527593	0.1445	1.40643	0.166	-1.23121
		0.102	-0.175853	0.1235	-0.527593	0.145	2.10938	0.1665	-1.58308
		0.1025	0.175842	0.124	-1.935	0.1455	2.46079	0.167	-2.11097
		0.103	0	0.1245	-0.70348	0.146	3.16347	0.1675	-2.63896
		0.1035	0.175842	0.125	-0.527593	0.1465	3.16347	0.168	-3.34311
		0.104	0	0.1255	-0.879378	0.147	3.33911	0.1685	-3.51917
		0.1045	-0.175853	0.126	-1.935	0.1475	3.86597	0.169	-4.04743
		0.105	-0.175853	0.1265	-1.23121	0.148	3.69036	0.1695	-4.39966
		0.1055	0	0.127	-0.351718	0.1485	3.69036	0.17	-4.75193
		0.106	0	0.1275	-0.527593	0.149	3.51474	0.1705	-4.57579
		0.1065	0	0.128	-0.527593	0.1495	3.69036	0.171	-4.39966
		0.107	-0.351718	0.1285	-0.879378	0.15	3.16347	0.1715	-4.04743
		0.1075	0	0.129	-0.70348	0.1505	3.16347	0.172	-3.69525
		0.108	0	0.1295	-0.70348	0.151	2.46079	0.1725	-3.16706
		0.1085	-0.175853	0.13	-0.527593	0.1515	1.58218	0.173	-2.46296

Gauge35_6 Time msec	Gauge35_6 Stress MPa	Gauge35_6 Time msec	Gauge35_6 Stress MPa	Gauge35_6 Time msec	Gauge35_6 Stress MPa
0.1735	-1.75903	0.195	1.05489	0.2165	2.28509
0.174	-0.879378	0.1955	1.40643	0.217	2.98781
0.1745	0.175842	0.196	1.93366	0.2175	3.51474
0.175	0.703303	0.1965	2.10938	0.218	3.51474
0.1755	1.75793	0.197	2.63647	0.2185	3.69036
0.176	2.81215	0.1975	2.46079	0.219	3.69036
0.1765	3.51474	0.198	2.46079	0.2195	3.69036
0.177	4.5683	0.1985	1.93366	0.22	3.51474
0.1775	5.27045	0.199	1.75793	0.2205	3.16347
0.178	6.14789	0.1995	1.58218	0.221	2.81215
0.1785	6.67423	0.2	0.879101	0.2215	2.28509
0.179	7.20046	0.2005	0.703303	0.222	1.93366
0.1795	7.55122	0.201	0.351674		
0.18	7.72659	0.2015	0.351674		
0.1805	7.90194	0.202	0.351674		
0.181	7.55122	0.2025	0.351674		
0.1815	7.37585	0.203	0.703303		
0.182	7.02506	0.2035	0.879101		
0.1825	6.84965	0.204	1.40643		
0.183	6.49879	0.2045	1.75793		
0.1835	5.97243	0.205	2.10938		
0.184	5.62146	0.2055	2.46079		
0.1845	4.74386	0.206	2.98781		
0.185	3.86597	0.2065	3.16347		
0.1855	2.63647	0.207	3.16347		
0.186	1.93366	0.2075	3.16347		
0.1865	0.703303	0.208	3.16347		
0.187	-0.175853	0.2085	3.16347		
0.1875	-1.23121	0.209	3.16347		
0.188	-1.935	0.2095	2.98781		
0.1885	-2.46296	0.21	2.98781		
0.189	-2.81498	0.2105	2.98781		
0.1895	-2.63896	0.211	2.81215		
0.19	-2.46296	0.2115	2.81215		
0.1905	-2.28696	0.212	2.63647		
0.191	-2.11097	0.2125	2.46079		
0.1915	-2.11097	0.213	2.28509		
0.192	-1.75903	0.2135	2.28509		
0.1925	-1.05529	0.214	2.10938		
0.193	-0.70348	0.2145	2.10938		
0.1935	-0.351718	0.215	2.10938		
0.194	0	0.2155	2.28509		
0.1945	0.527494	0.216	2.28509		

Gauge36_1 Time msec	Gauge36_1 Stress MPa	Gauge36_1 Time msec	Gauge36_1 Stress MPa	Gauge36_1 Time msec	Gauge36_1 Stress MPa	Gauge36_2 Time msec	Gauge36_2 Stress MPa	Gauge36_2 Time msec	Gauge36_2 Stress MPa
-0.0325	19.3949	-0.011	0	0.0105	76.866	0.039	1.10075	0.0605	9.16023
-0.032	19.3949	-0.0105	0	0.011	95.7851	0.0395	1.10075	0.061	9.16023
-0.0315	19.3949	-0.01	0	0.0115	-58.8984	0.04	1.10075	0.0615	6.96441
-0.031	0	-0.0095	0	0.012	38.6709	0.0405	1.10075	0.062	4.03406
-0.0305	19.3949	-0.009	0	0.0125	38.6709	0.041	0.733881	0.0625	1.46758
-0.03	19.3949	-0.0085	0	0.013	-39.1467	0.0415	0.733881	0.063	-1.83551
-0.0295	0	-0.008	0	0.0135	133.266	0.042	0.733881	0.0635	-5.14235
-0.029	0	-0.0075	0	0.014	-39.1467	0.0425	0.733881	0.064	-6.98109
-0.0285	0	-0.007	0	0.0145	-98.7588	0.043	0.733881	0.0645	-6.61325
-0.028	0	-0.0065	0	0.015	-58.8984	0.0435	0.733881	0.065	-5.51
-0.0275	0	-0.006	0	0.0155	-78.7692	0.044	0.366964	0.0655	-5.87771
-0.027	0	-0.0055	0	0.016	-39.1467	0.0445	0.366964	0.066	-5.51
-0.0265	0	-0.005	0	0.0165	-78.7692	0.045	0.366964	0.0665	-5.14235
-0.026	0	-0.0045	0	0.017	-39.1467	0.0455	0.366964	0.067	-4.40717
-0.0255	0	-0.004	0	0.0175	0	0.046	0.366964	0.0675	-4.77473
-0.025	19.3949	-0.0035	0	0.018	-98.7588	0.0465	0.366964	0.068	-5.14235
-0.0245	0	-0.003	0	0.0185	-118.867	0.047	0	0.0685	-4.77473
-0.024	19.3949	-0.0025	0	0.019	-118.867	0.0475	0.366964	0.069	-4.77473
-0.0235	19.3949	-0.002	0	0.0195	-58.8984	0.048	0	0.0695	-4.77473
-0.023	0	-0.0015	0	0.02	-78.7692	0.0485	0	0.07	-5.51
-0.0225	19.3949	-0.001	0	0.0205	-58.8984	0.049	0.366964	0.0705	-6.61325
-0.022	0	-0.0005	0	0.021	-58.8984	0.0495	0.366964	0.071	-6.61325
-0.0215	0	0	0	0.0215	-39.1467	0.05	0.366964	0.0715	-6.61325
-0.021	0	0.0005	95.7851	0.022	-39.1467	0.0505	0.366964	0.072	-6.24545
-0.0205	19.3949	0.001	188.596	0.0225	-58.8984	0.051	0	0.0725	-6.61325
-0.02	19.3949	0.0015	314.415	0.023	0	0.0515	0	0.073	-6.61325
-0.0195	0	0.002	435.093	0.0235	38.6709	0.052	0	0.0735	-6.24545
-0.019	38.6709	0.0025	823.109	0.024	57.8279	0.0525	-0.36701	0.074	-6.24545
-0.0185	0	0.003	823.109	0.0245	57.8279	0.053	-0.36701	0.0745	-6.61325
-0.018	0	0.0035	794.11	0.025	38.6709	0.0535	0	0.075	-6.98109
-0.0175	0	0.004	765.495	0.0255	57.8279	0.054	0.366964	0.0755	-6.61325
-0.017	0	0.0045	628.684	0.026	57.8279	0.0545	0	0.076	-6.61325
-0.0165	0	0.005	392.322	0.0265	38.6709	0.055	-0.36701	0.0765	-6.61325
-0.016	0	0.0055	188.596	0.027	57.8279	0.0555	-0.36701	0.077	-6.98109
-0.0155	0	0.006	151.829	0.0275	0	0.056	0.366964	0.0775	-6.98109
-0.015	0	0.0065	76.866	0.028	0	0.0565	0.733881	0.078	-6.98109
-0.0145	0	0.007	133.266	0.0285	38.6709	0.057	2.20109	0.0785	-6.98109
-0.014	0	0.0075	314.415	0.029	0	0.0575	6.2321	0.079	-6.98109
-0.0135	0	0.008	170.272	0.0295	0	0.058	12.4508	0.0795	-6.98109
-0.013	0	0.0085	314.415	0.03	38.6709	0.0585	16.8325	0.08	-6.98109
-0.0125	0	0.009	170.272	0.0305	38.6709	0.059	15.0076	0.0805	-6.98109
-0.012	0	0.0095	76.866	0.031	38.6709	0.0595	9.8918	0.081	-5.51
-0.0115	0	0.01	95.7851			0.06	8.06253	0.0815	-5.51

GaugeJ6_2	GaugeJ6_2	GaugeJ6_2	GaugeJ6_2	GaugeJ6_2	GaugeJ6_2	GaugeJ6_2	GaugeJ6_2	GaugeJ6_2	GaugeJ6_2
Time	Stress	Time	Stress	Time	Stress	Time	Stress	Time	Stress
msec	MPa	msec	MPa	msec	MPa	msec	MPa	msec	MPa
0.082	-5.14235	0.1035	-4.40717	0.125	-7.34898	0.1465	-1.83551	0.168	1.83436
0.0825	-4.40717	0.104	-5.51	0.1255	-8.45292	0.147	-1.10117	0.1685	1.83436
0.083	-4.40717	0.1045	-5.51	0.126	-8.08489	0.1475	-1.46832	0.169	0.366964
0.0835	-4.40717	0.105	-5.14235	0.1265	-8.08489	0.148	-1.46832	0.1695	-1.83551
0.084	-3.67218	0.1055	-5.14235	0.127	-8.82099	0.1485	-1.83551	0.17	-1.10117
0.0845	-3.67218	0.106	-4.77473	0.1275	-8.82099	0.149	-1.83551	0.1705	-0.734066
0.085	-4.03965	0.1065	-5.14235	0.128	-8.82099	0.1495	-1.83551	0.171	-1.10117
0.0855	-4.40717	0.107	-5.51	0.1285	-8.82099	0.15	-2.93737	0.1715	-2.20275
0.086	-4.03965	0.1075	-5.51	0.129	-8.45292	0.1505	-3.30475	0.172	-2.20275
0.0865	-3.67218	0.108	-4.77473	0.1295	-7.71691	0.151	-4.03965	0.1725	-2.20275
0.087	-3.67218	0.1085	-4.77473	0.13	-6.98109	0.1515	-3.67218	0.173	-2.20275
0.0875	-3.67218	0.109	-5.14235	0.1305	-6.24545	0.152	-5.51	0.1735	-2.57004
0.088	-3.67218	0.1095	-4.77473	0.131	-5.87771	0.1525	-6.24545	0.174	-2.93737
0.0885	-3.67218	0.11	-5.51	0.1315	-5.14235	0.153	-6.61325	0.1745	-2.93737
0.089	-3.30475	0.1105	-5.51	0.132	-4.40717	0.1535	-7.34898	0.175	-2.57004
0.0895	-2.93737	0.111	-5.51	0.1325	-4.03965	0.154	-7.34898	0.1755	-2.20275
0.09	-2.57004	0.1115	-5.87771	0.133	-4.03965	0.1545	-8.08489	0.176	-2.20275
0.0905	-2.20275	0.112	-6.24545	0.1335	-4.03965	0.155	-8.45292	0.1765	-2.20275
0.091	-1.83551	0.1125	-6.24545	0.134	-4.40717	0.1555	-9.18911	0.177	-1.46832
0.0915	-2.57004	0.113	-6.61325	0.1345	-4.77473	0.156	-9.92549	0.1775	-1.46832
0.092	-2.93737	0.1135	-6.24545	0.135	-5.87771	0.1565	-14.3476	0.178	-1.10117
0.0925	-2.93737	0.114	-6.24545	0.1355	-6.24545	0.157	-4.77473	0.1785	-0.734066
0.093	-3.30475	0.1145	-5.87771	0.136	-6.98109	0.1575	3.66756	0.179	0
0.0935	-2.57004	0.115	-5.51	0.1365	-7.71691	0.158	-8.82099	0.1795	0.733881
0.094	-2.20275	0.1155	-4.40717	0.137	-9.18911	0.1585	-15.8232	0.18	2.56778
0.0945	-1.46832	0.116	-4.03965	0.1375	-9.92549	0.159	-8.45292	0.1805	1.10075
0.095	-1.46832	0.1165	-4.40717	0.138	-11.0304	0.1595	1.83436	0.181	1.46758
0.0955	-1.46832	0.117	-4.40717	0.1385	-12.1357	0.16	-7.71691	0.1815	1.83436
0.096	-0.734066	0.1175	-4.40717	0.139	-12.1357	0.1605	-17.2994	0.182	1.83436
0.0965	0	0.118	-3.67218	0.1395	-12.5043	0.161	-11.3988	0.1825	1.83436
0.097	0	0.1185	-4.40717	0.14	-14.7164	0.1615	3.30101	0.183	2.56778
0.0975	0	0.119	-4.77473	0.1405	-12.1357	0.162	2.56778	0.1835	2.93442
0.098	-0.36701	0.1195	-4.77473	0.141	-11.0304	0.1625	-3.67218	0.184	2.93442
0.0985	-1.10117	0.12	-4.77473	0.1415	-10.2937	0.163	-12.5043	0.1845	3.66756
0.099	-1.83551	0.1205	-4.77473	0.142	-9.92549	0.1635	-4.03965	0.185	3.66756
0.0995	-2.20275	0.121	-4.40717	0.1425	-9.18911	0.164	8.42848	0.1855	4.03406
0.1	-2.57004	0.1215	-4.40717	0.143	-7.71691	0.1645	1.46758	0.186	4.76692
0.1005	-2.93737	0.122	-4.40717	0.1435	-6.98109	0.165	-6.98109	0.1865	4.76692
0.101	-3.67218	0.1225	-5.14235	0.144	-6.61325	0.1655	-2.20275	0.187	5.13329
0.1015	-4.03965	0.123	-5.87771	0.1445	-5.14235	0.166	5.86588	0.1875	5.4996
0.102	-4.40717	0.1235	-5.87771	0.145	-4.40717	0.1665	3.30101	0.188	5.86588
0.1025	-4.40717	0.124	-5.87771	0.1455	-3.30475	0.167	0	0.1885	6.2321
0.103	-4.77473	0.1245	-6.24545	0.146	-2.20275	0.1675	-1.46832	0.189	6.96441

GaugeJ6_2	GaugeJ6_2	GaugeJ6_3	GaugeJ6_3	GaugeJ6_3	GaugeJ6_3	GaugeJ6_3	GaugeJ6_3	GaugeJ6_3	GaugeJ6_3
Time	Stress	Time	Stress	Time	Stress	Time	Stress	Time	Stress
msec	MPa	msec	MPa	msec	MPa	msec	MPa	msec	MPa
0.1895	6.96441	0.0285	0	0.05	0	0.0715	-3.62915	0.093	-5.80883
0.19	0.733881	0.029	0.725281	0.0505	0	0.072	-3.99231	0.0935	-6.53755
0.1905	6.96441	0.0295	0	0.051	0	0.0725	-3.26603	0.094	-6.89928
0.191	6.2321	0.03	0.362663	0.0515	0	0.073	-3.26603	0.0945	-7.26286
0.1915	6.2321	0.0305	0.362663	0.052	0	0.0735	-2.90295	0.095	-7.62648
0.192	5.4996	0.031	0	0.0525	0	0.074	-2.53992	0.0955	-7.62648
0.1925	5.13329	0.0315	0	0.053	0	0.0745	-2.53992	0.096	-6.89928
0.193	4.03406	0.032	0.362663	0.0535	0	0.075	-2.90295	0.0965	-6.53755
0.1935	2.93442	0.0325	0	0.054	0	0.0755	-3.26603	0.097	-6.53755
0.194	3.30101	0.033	0.362663	0.0545	0	0.076	-3.62915	0.0975	-6.17227
0.1945	6.59828	0.0335	0.362663	0.055	0	0.0765	-4.35552	0.098	-5.44543
0.195	2.20109	0.034	0	0.0555	0	0.077	-4.71878	0.0985	-5.44543
0.1955	-2.57004	0.0345	0	0.056	0	0.0775	-4.71878	0.099	-5.44543
0.196	-4.77473	0.035	0	0.0565	-0.362709	0.078	-4.35552	0.0995	-5.08208
0.1965	-3.30475	0.0355	0.362663	0.057	0	0.0785	-4.35552	0.1	-4.35552
0.197	-1.10117	0.036	0	0.0575	0	0.079	-3.99231	0.1005	-4.35552
0.1975	3.66756	0.0365	0	0.058	0.362663	0.0795	-3.99231	0.101	-3.99231
0.198	-2.57004	0.037	0	0.0585	0.362663	0.08	-3.99231	0.1015	-3.99231
0.1985	-4.40717	0.0375	0	0.059	0.725281	0.0805	-4.35552	0.102	-3.26603
0.199	-5.51	0.038	0	0.0595	3.62458	0.081	-3.99231	0.1025	-3.26603
0.1995	-5.51	0.0385	0	0.06	10.1373	0.0815	-3.99231	0.103	-2.90295
0.2	-5.14235	0.039	0	0.0605	14.4709	0.082	-4.35552	0.1035	-2.53992
0.2005	-5.51	0.0395	0.362663	0.061	15.914	0.0825	-4.35552	0.104	-1.814
0.201	-6.24545	0.04	0	0.0615	13.3881	0.083	-4.35552	0.1045	-1.814
0.2015	-6.98109	0.0405	0	0.062	9.77588	0.0835	-4.35552	0.105	-0.725464
0.202	-7.34898	0.041	-0.362709	0.0625	6.8828	0.084	-3.99231	0.1055	-0.362709
0.2025	-6.98109	0.0415	0	0.063	5.43516	0.0845	-3.99231	0.106	0
0.203	-6.61325	0.042	0	0.0635	4.34895	0.085	-3.62915	0.1065	0.362663
		0.0425	0	0.064	4.34895	0.0855	-3.62915	0.107	1.08785
		0.043	0	0.0645	2.90003	0.086	-3.26603	0.1075	1.45038
		0.0435	0	0.065	1.08785	0.0865	-3.26603	0.108	1.81286
		0.044	0	0.0655	-0.725464	0.087	-3.26603	0.1085	1.81286
		0.0445	0	0.066	-2.17694	0.0875	-3.62915	0.109	1.45038
		0.045	0	0.0665	-2.17694	0.088	-3.26603	0.1095	1.81286
		0.0455	0	0.067	-2.17694	0.0885	-3.26603	0.11	1.08785
		0.046	0	0.0675	-2.17694	0.089	-2.53992	0.1105	1.08785
		0.0465	0	0.068	-2.17694	0.0895	-1.08826	0.111	1.08785
		0.047	0	0.0685	-2.17694	0.09	-1.08826	0.1115	0.725281
		0.0475	0	0.069	-2.17694	0.0905	-1.08826	0.112	0
		0.048	0	0.0695	-2.53992	0.091	-1.45111	0.1125	-0.362709
		0.0485	-0.362709	0.07	-2.53992	0.0915	-2.53992	0.113	-0.725464
		0.049	0	0.0705	-2.90295	0.092	-3.99231	0.1135	-1.08826
		0.0495	0	0.071	-3.62915	0.0925	-5.08208	0.114	-1.45111

Gauge36_3	Gauge36_3	Gauge36_3	Gauge36_3	Gauge36_3	Gauge36_3	Gauge36_3	Gauge36_3	Gauge36_3	Gauge36_3
Time	Stress	Time	Stress	Time	Stress	Time	Stress	Time	Stress
msec	MPa	msec	MPa	msec	MPa	msec	MPa	msec	MPa
0.1145	-1.08826	0.136	-0.362709	0.1575	-5.08208	0.179	0.362663	0.2005	-2.53992
0.115	-0.725464	0.1365	-1.45111	0.158	-5.44543	0.1795	-0.362709	0.201	-2.53992
0.1155	-1.08826	0.137	-2.17694	0.1585	-5.44543	0.18	0	0.2015	-2.53992
0.116	-0.725464	0.1375	-3.62915	0.159	-5.44543	0.1805	-0.362709	0.202	-2.53992
0.1165	-0.362709	0.138	-4.71878	0.1595	-5.44543	0.181	-0.362709	0.2025	-2.53992
0.117	-0.362709	0.1385	-5.44543	0.16	-5.44543	0.1815	0	0.203	-2.53992
0.1175	0	0.139	-6.17227	0.1605	-5.80883	0.182	0	0.2035	-2.53992
0.118	0.362663	0.1395	-6.53575	0.161	-5.44543	0.1825	0	0.204	-2.17694
0.1185	0.725281	0.14	-6.89928	0.1615	-5.44543	0.183	0.362663	0.2045	-1.814
0.119	1.45038	0.1405	-6.89928	0.162	-5.44543	0.1835	0.725281	0.205	-1.814
0.1195	1.08785	0.141	-6.89928	0.1625	-5.44543	0.184	0.725281	0.2055	-1.814
0.12	1.45038	0.1415	-6.17227	0.163	-5.08208	0.1845	1.08785	0.206	-1.814
0.1205	1.81286	0.142	-5.80883	0.1635	-5.08208	0.185	1.08785	0.2065	-1.814
0.121	2.1753	0.1425	-5.08208	0.164	-4.71878	0.1855	1.81286	0.207	-1.814
0.1215	2.1753	0.143	-4.35552	0.1645	-4.71878	0.186	2.1753	0.2075	-2.17694
0.122	1.81286	0.1435	-3.62915	0.165	-4.35552	0.1865	2.1753	0.208	-2.90295
0.1225	1.08785	0.144	-2.90295	0.1655	-4.71878	0.187	2.1753	0.2085	-3.62915
0.123	0.725281	0.1445	-1.814	0.166	-3.62915	0.1875	2.1753	0.209	-4.71878
0.1235	-0.725464	0.145	-1.45111	0.1665	-3.26603	0.188	2.90003	0.2095	-5.44543
0.124	-1.08826	0.1455	-1.45111	0.167	-3.26603	0.1885	3.26233	0.21	-6.89928
0.1245	-2.17694	0.146	-0.725464	0.1675	-3.26603	0.189	2.90003	0.2105	-7.26286
0.125	-3.62915	0.1465	-0.362709	0.168	-1.814	0.1895	3.62458	0.211	-8.35386
0.1255	-5.08208	0.147	-0.362709	0.1685	-1.814	0.19	3.62458	0.2115	-9.44528
0.126	-5.44543	0.1475	-0.362709	0.169	-1.08826	0.1905	3.62458	0.212	-9.80918
0.1265	-5.80883	0.148	0	0.1695	-1.08826	0.191	3.62458	0.2125	-10.1731
0.127	-6.53575	0.1485	-0.362709	0.17	-0.725464	0.1915	3.62458		
0.1275	-7.26286	0.149	-0.362709	0.1705	-0.725464	0.192	3.26233		
0.128	-7.26286	0.1495	-0.362709	0.171	-0.725464	0.1925	2.90003		
0.1285	-7.26286	0.15	0	0.1715	-0.362709	0.193	2.1753		
0.129	-6.89928	0.1505	0	0.172	-0.362709	0.1935	1.81286		
0.1295	-6.53575	0.151	0	0.1725	-0.362709	0.194	1.45038		
0.13	-5.80883	0.1515	-0.725464	0.173	-0.362709	0.1945	1.08785		
0.1305	-5.08208	0.152	-0.362709	0.1735	-0.362709	0.195	0.362663		
0.131	-4.35552	0.1525	-0.725464	0.174	0	0.1955	-0.362709		
0.1315	-3.26603	0.153	-1.45111	0.1745	0	0.196	-0.725464		
0.132	-1.814	0.1535	-1.814	0.175	0.362663	0.1965	-0.725464		
0.1325	-0.725464	0.154	-2.53992	0.1755	0.362663	0.197	-1.45111		
0.133	0	0.1545	-2.53992	0.176	0	0.1975	-1.45111		
0.1335	0.362663	0.155	-3.26603	0.1765	0.725281	0.198	-2.17694		
0.134	0.725281	0.1555	-3.26603	0.177	1.08785	0.1985	-1.814		
0.1345	0.362663	0.156	-4.35552	0.1775	1.08785	0.199	-2.17694		
0.135	0	0.1565	-4.35552	0.178	1.08785	0.1995	-2.53992		
0.1355	0	0.157	-4.71878	0.1785	0.725281	0.2	-2.53992		

Gauge36_4	Gauge36_4	Gauge36_4	Gauge36_4	Gauge36_4	Gauge36_4	Gauge36_4	Gauge36_4	Gauge36_4	Gauge36_4
Time	Stress	Time	Stress	Time	Stress	Time	Stress	Time	Stress
msec	MPa	msec	MPa	msec	MPa	msec	MPa	msec	MPa
0.091	0.992836	0.1125	0.330987	0.134	8.92202	0.1555	4.96043	0.177	10.2412
0.0915	0.992836	0.113	0	0.1345	7.93218	0.156	4.29958	0.1775	10.2412
0.092	0.992836	0.1135	0.330987	0.135	7.27208	0.1565	6.28162	0.178	10.5709
0.0925	0.992836	0.114	-0.331029	0.1355	6.94197	0.157	5.95139	0.1785	10.9006
0.093	0.992836	0.1145	0	0.136	6.94197	0.1575	5.29079	0.179	10.9006
0.0935	0.661932	0.115	-0.331029	0.1365	7.27208	0.158	4.96043	0.1795	11.2302
0.094	0.992836	0.1155	0	0.137	7.93218	0.1585	4.63002	0.18	11.5597
0.0945	0.661932	0.116	0	0.1375	8.59211	0.159	4.63002	0.1805	11.2302
0.095	1.3237	0.1165	0	0.138	7.93218	0.1595	3.96909	0.181	10.5709
0.0955	0.992836	0.117	-0.331029	0.1385	7.27208	0.16	4.29958	0.1815	10.9006
0.096	0.992836	0.1175	-0.331029	0.139	6.61182	0.1605	3.96909	0.182	10.2412
0.0965	1.3237	0.118	0	0.1395	6.61182	0.161	4.63002	0.1825	10.5709
0.097	0.992836	0.1185	0	0.14	6.61182	0.1615	4.96043	0.183	10.9006
0.0975	0.992836	0.119	0	0.1405	6.61182	0.162	5.62111	0.1835	10.2412
0.098	1.3237	0.1195	0	0.141	6.94197	0.1625	5.29079	0.184	10.2412
0.0985	0.992836	0.12	0	0.1415	7.27208	0.163	5.95139	0.1845	10.2412
0.099	1.3237	0.1205	0.330987	0.142	7.60215	0.1635	5.95139	0.185	10.2412
0.0995	0.992836	0.121	0.661932	0.1425	7.27208	0.164	6.61182	0.1855	10.2412
0.1	0.992836	0.1215	0.661932	0.143	6.94197	0.1645	5.95139	0.186	10.2412
0.1005	0.992836	0.122	0.992836	0.1435	6.61182	0.165	6.61182	0.1865	10.2412
0.101	0.992836	0.1225	1.65452	0.144	6.61182	0.1655	6.61182	0.187	10.2412
0.1015	0.992836	0.123	3.30799	0.1445	6.28162	0.166	7.27208	0.1875	10.2412
0.102	1.3237	0.1235	6.94197	0.145	5.95139	0.1665	6.94197	0.188	10.2412
0.1025	0.992836	0.124	9.91148	0.1455	5.95139	0.167	6.94197	0.1885	9.91148
0.103	0.992836	0.1245	10.9006	0.146	5.95139	0.1675	6.61182	0.189	9.25188
0.1035	0.661932	0.125	9.5817	0.1465	6.28162	0.168	7.27208	0.1895	9.25188
0.104	0.992836	0.1255	7.27208	0.147	6.28162	0.1685	7.60215	0.19	10.5709
0.1045	0.661932	0.126	3.96909	0.1475	6.28162	0.169	7.60215	0.1905	8.26217
0.105	0.992836	0.1265	1.65452	0.148	6.94197	0.1695	7.60215	0.191	8.26217
0.1055	0.661932	0.127	0.661932	0.1485	6.61182	0.17	7.60215	0.1915	7.27208
0.106	0.661932	0.1275	1.3237	0.149	6.28162	0.1705	8.26217	0.192	6.94197
0.1065	0.661932	0.128	2.31603	0.1495	6.28162	0.171	7.93218	0.1925	6.61182
0.107	0.661932	0.1285	3.63856	0.15	5.95139	0.1715	8.26217	0.193	5.95139
0.1075	0.992836	0.129	6.28162	0.1505	5.62111	0.172	7.93218	0.1935	5.29079
0.108	0.992836	0.1295	9.5817	0.151	5.29079	0.1725	7.93218	0.194	5.29079
0.1085	0.330987	0.13	12.5482	0.1515	5.29079	0.173	8.26217	0.1945	4.29958
0.109	0.661932	0.1305	12.8776	0.152	5.29079	0.1735	8.26217	0.195	4.29958
0.1095	0.330987	0.131	12.8776	0.1525	4.96043	0.174	8.92202	0.1955	3.96909
0.11	0.330987	0.1315	12.2188	0.153	5.29079	0.1745	8.59211	0.196	4.29958
0.1105	0	0.132	12.2188	0.1535	5.62111	0.175	8.92202	0.1965	3.63856
0.111	0.330987	0.1325	11.5597	0.154	5.29079	0.1755	9.25188	0.197	3.63856
0.1115	0.330987	0.133	10.5709	0.1545	4.96043	0.176	9.25188	0.1975	3.07979
0.112	0	0.1335	9.5817	0.155	4.96043	0.1765	9.5817	0.198	2.64673

Gauge36_4 Time msec	Gauge36_4 Stress MPa	Gauge36_5 Time msec	Gauge36_5 Stress MPa	Gauge36_5 Time msec	Gauge36_5 Stress MPa	Gauge36_5 Time msec	Gauge36_5 Stress MPa	Gauge36_5 Time msec	Gauge36_5 Stress MPa
0.1985	2.64673	0.0865	-0.359897	0.108	-1.43986	0.1295	10.7759	0.151	5.7522
0.199	1.9853	0.087	0	0.1085	-1.79994	0.13	11.1343	0.1515	5.7522
0.1995	1.65452	0.0875	0	0.109	-1.79994	0.1305	11.8512	0.152	5.39302
0.2	1.65452	0.088	0	0.1095	-1.79994	0.131	11.8512	0.1525	5.03381
0.2005	1.65452	0.0885	-0.359897	0.11	-1.79994	0.1315	12.5679	0.153	4.31523
		0.089	0	0.1105	-1.79994	0.132	11.4928	0.1535	4.31523
		0.0895	0	0.111	-1.43986	0.1325	10.4173	0.154	4.31523
		0.09	0	0.1115	-1.79994	0.133	9.7001	0.1545	3.95588
		0.0905	0	0.112	-1.43986	0.1335	9.34143	0.155	3.23704
		0.091	0	0.1125	-1.07983	0.134	10.0587	0.1555	3.59648
		0.0915	0	0.113	-1.07983	0.1345	10.7759	0.156	2.51801
		0.092	0	0.1135	-0.71984	0.135	11.4928	0.1565	1.43914
		0.0925	0	0.114	-0.359897	0.1355	12.2095	0.157	0.719659
		0.093	0	0.1145	0.359852	0.136	12.2095	0.1575	0.359852
		0.0935	0	0.115	0.359852	0.1365	12.2095	0.158	0
		0.094	0	0.1155	1.07942	0.137	12.2095	0.1585	-0.71984
		0.0945	0	0.116	1.07942	0.1375	12.2095	0.159	-1.07983
		0.095	-0.359897	0.1165	2.51801	0.138	12.2095	0.1595	-1.43986
		0.0955	0	0.117	4.67454	0.1385	12.2095	0.16	-1.43986
		0.096	-0.359897	0.1175	6.4704	0.139	11.8512	0.1605	-2.16006
		0.0965	0	0.118	9.7001	0.1395	12.2095	0.161	-2.16006
		0.097	0	0.1185	10.0587	0.14	11.8512	0.1615	-2.16006
		0.0975	0	0.119	9.34143	0.1405	11.4928	0.162	-2.16006
		0.098	0	0.1195	9.34143	0.141	11.1343	0.1625	-2.52023
		0.0985	0	0.12	9.34143	0.1415	10.7759	0.163	-2.52023
		0.099	0	0.1205	9.7001	0.142	10.7759	0.1635	-2.52023
		0.0995	0	0.121	10.0587	0.1425	10.7759	0.164	-2.16006
		0.1	-0.359897	0.1215	10.0587	0.143	11.1343	0.1645	-2.16006
		0.1005	0	0.122	9.34143	0.1435	11.1343	0.165	-1.43986
		0.101	0	0.1225	8.62394	0.144	11.1343	0.1655	-1.79994
		0.1015	0	0.123	6.4704	0.1445	10.7759	0.166	-1.43986
		0.102	-0.359897	0.1235	5.7522	0.145	10.4173	0.1665	-1.43986
		0.1025	0	0.124	7.54738	0.1455	10.0587	0.167	-1.07983
		0.103	-0.359897	0.1245	10.7759	0.146	9.7001	0.1675	-0.71984
		0.1035	-0.71984	0.125	13.6425	0.1465	9.34143	0.168	-0.359897
		0.104	-0.71984	0.1255	15.4327	0.147	8.62394	0.1685	0
		0.1045	-0.71984	0.126	16.8641	0.1475	8.62394	0.169	0
		0.105	-1.07983	0.1265	17.5795	0.148	8.26513	0.1695	0.359852
		0.1055	-1.07983	0.127	17.5795	0.1485	7.90628	0.17	0.719659
		0.106	-1.07983	0.1275	16.8641	0.149	7.54738	0.1705	0.719659
		0.1065	-0.71984	0.128	15.7906	0.1495	7.18843	0.171	0.719659
		0.107	-1.43986	0.1285	13.6425	0.15	6.82944	0.1715	0.719659
		0.1075	-1.43986	0.129	11.1343	0.1505	6.4704	0.172	0.719659

Gauge36_5 Time msec	Gauge36_5 Stress MPa	Gauge36_5 Time msec	Gauge36_5 Stress MPa	Gauge36_5 Time msec	Gauge36_5 Stress MPa	Gauge36_6 Time msec	Gauge36_6 Stress MPa	Gauge36_6 Time msec	Gauge36_6 Stress MPa
0.1725	0.359852	0.194	-6.8458	0.2155	-4.6822	0.092	-0.177875	0.1135	-0.889486
0.173	0.359852	0.1945	-6.8458	0.216	-5.04269	0.0925	0.177864	0.114	-0.889486
0.1735	0	0.195	-6.48509			0.093	0.177864	0.1145	-0.889486
0.174	0	0.1955	-6.8458			0.0935	0	0.115	-0.889486
0.1745	-0.359897	0.196	-7.20656			0.094	-0.177875	0.1155	-1.06742
0.175	-0.359897	0.1965	-7.56736			0.0945	-0.177875	0.116	-1.24536
0.1755	-1.07983	0.197	-7.92821			0.095	-0.177875	0.1165	-1.42331
0.176	-2.16006	0.1975	-7.56736			0.0955	-0.177875	0.117	-1.24536
0.1765	-2.16006	0.198	-7.92821			0.096	0	0.1175	-1.06742
0.177	-2.16006	0.1985	-7.56736			0.0965	0	0.118	-0.889486
0.1775	-3.24071	0.199	-8.65004			0.097	0.177864	0.1185	-0.711566
0.178	-3.60101	0.1995	-8.2891			0.0975	0.177864	0.119	-0.533658
0.1785	-3.60101	0.2	-8.2891			0.098	-0.177875	0.1195	-0.355761
0.179	-4.6822	0.2005	-7.92821			0.0985	0.177864	0.12	-0.355761
0.1795	-5.7638	0.201	-8.2891			0.099	0	0.1205	0.355716
0.18	-5.40322	0.2015	-7.92821			0.0995	0	0.121	0.533557
0.1805	-5.7638	0.202	-7.56736			0.1	0	0.1215	0.533557
0.181	-6.8458	0.2025	-7.20656			0.1005	0	0.122	0.533557
0.1815	-7.20656	0.203	-6.8458			0.101	0.177864	0.1225	0.711387
0.182	-7.92821	0.2035	-6.48509			0.1015	0	0.123	0.889206
0.1825	-7.20656	0.204	-5.7638			0.102	0	0.1235	0.889206
0.183	-7.56736	0.2045	-5.04269			0.1025	0.177864	0.124	0.711387
0.1835	-7.92821	0.205	-4.6822			0.103	0.177864	0.1245	0.889206
0.184	-7.92821	0.2055	-4.32176			0.1035	-0.355761	0.125	0.889206
0.1845	-7.92821	0.206	-4.32176			0.104	0.355716	0.1255	0.889206
0.185	-7.56736	0.2065	-3.96136			0.1045	0.177864	0.126	0.533557
0.1855	-7.56736	0.207	-3.60101			0.105	0	0.1265	0.533557
0.186	-7.56736	0.2075	-3.60101			0.1055	-0.177875	0.127	-0.355761
0.1865	-6.48509	0.208	-4.32176			0.106	0.177864	0.1275	-0.711566
0.187	-5.40322	0.2085	-3.96136			0.1065	-0.177875	0.128	-0.355761
0.1875	-5.40322	0.209	-4.32176			0.107	0.177864	0.1285	-0.711566
0.188	-5.7638	0.2095	-3.96136			0.1075	0.177864	0.129	-0.711566
0.1885	-4.6822	0.21	-3.60101			0.108	0.177864	0.1295	-0.711566
0.189	-5.04269	0.2105	-3.24071			0.1085	0.177864	0.13	-0.889486
0.1895	-4.6822	0.211	-2.88045			0.109	0.355716	0.1305	-1.06742
0.19	-4.32176	0.2115	-2.88045			0.1095	0.177864	0.131	-1.06742
0.1905	-4.6822	0.212	-2.88045			0.11	-0.177875	0.1315	-1.06742
0.191	-4.32176	0.2125	-2.88045			0.1105	-0.355761	0.132	-0.889486
0.1915	-5.04269	0.213	-2.88045			0.111	0.889206	0.1325	-1.06742
0.192	-5.7638	0.2135	-3.24071			0.1115	-0.177875	0.133	-1.06742
0.1925	-5.7638	0.214	-3.60101			0.112	-0.533658	0.1335	-1.06742
0.193	-6.48509	0.2145	-4.32176			0.1125	-0.177875	0.134	-1.06742
0.1935	-5.7638	0.215	-4.6822			0.113	-0.355761	0.1345	-0.889486

Gauge36_6 Time msec	Gauge36_6 Stress MPa	Gauge36_6 Time msec	Gauge36_6 Stress MPa	Gauge36_6 Time msec	Gauge36_6 Stress MPa	Gauge36_6 Time msec	Gauge36_6 Stress MPa
0.135	-0.889486	0.1565	1.24481	0.178	0	0.1995	-3.20346
0.1355	-0.711566	0.157	1.77813	0.1785	-0.533658	0.2	-3.38153
0.136	-0.533658	0.1575	1.06701	0.179	-0.889486	0.2005	-3.55962
0.1365	-0.355761	0.158	0.711387	0.1795	0.177864	0.201	-3.73772
0.137	-0.177875	0.1585	0.533557	0.18	1.24481	0.2015	-3.38153
0.1375	0	0.159	0.533557	0.1805	3.91041	0.202	-3.73772
0.138	0	0.1595	0.355716	0.181	7.63802	0.2025	-3.38153
0.1385	0.177864	0.16	0.177864	0.1815	9.94311	0.203	-3.38153
0.139	0.177864	0.1605	-0.177875	0.182	6.21856	0.2035	-3.38153
0.1395	0	0.161	-0.177875	0.1825	3.91041	0.204	-3.38153
0.14	-0.177875	0.1615	-1.06742	0.183	1.06701	0.2045	-3.20346
0.1405	0.177864	0.162	-1.24536	0.1835	0.177864	0.205	-3.20346
0.141	0.177864	0.1625	-1.77925	0.184	-0.889486	0.2055	-3.02539
0.1415	-0.177875	0.163	-2.13524	0.1845	-1.24536	0.206	-3.02539
0.142	0	0.1635	-2.49127	0.185	-2.31324	0.2065	-2.6693
0.1425	-0.355761	0.164	-2.84734	0.1855	-2.84734	0.207	-2.49127
0.143	-0.711566	0.1645	-3.02539	0.186	-3.73772	0.2075	-2.31324
0.1435	-0.711566	0.165	-3.02539	0.1865	-4.45023	0.208	-2.31324
0.144	-1.24536	0.1655	-3.02539	0.187	-4.80655	0.2085	-2.13524
0.1445	-1.60128	0.166	-2.84734	0.1875	-4.45023	0.209	-1.77925
0.145	-1.77925	0.1665	-2.84734	0.188	-3.55962	0.2095	-1.60128
0.1455	-1.95724	0.167	-2.49127	0.1885	-2.84734	0.21	-1.24536
0.146	-2.6693	0.1675	-2.49127	0.189	-2.84734	0.2105	-0.889486
0.1465	-2.49127	0.168	-2.31324	0.1895	-2.49127	0.211	-0.533658
0.147	-2.49127	0.1685	-1.95724	0.19	-2.49127	0.2115	-0.177875
0.1475	-2.13524	0.169	-1.95724	0.1905	-2.49127	0.212	-0.711566
0.148	-1.77925	0.1695	-2.31324	0.191	-1.42331	0.2125	-0.711566
0.1485	-1.60128	0.17	-1.95724	0.1915	-2.31324	0.213	-1.06742
0.149	-1.77925	0.1705	-2.49127	0.192	-2.49127	0.2135	-1.42331
0.1495	-1.42331	0.171	-2.13524	0.1925	-3.20346	0.214	-0.889486
0.15	-1.24536	0.1715	-2.6693	0.193	-3.38153	0.2145	-0.889486
0.1505	-1.60128	0.172	-1.77925	0.1935	-3.38153	0.215	-1.06742
0.151	-1.60128	0.1725	-2.31324	0.194	-3.02539	0.2155	-1.42331
0.1515	-1.24536	0.173	-2.13524	0.1945	-3.20346	0.216	-0.889486
0.152	-1.42331	0.1735	-1.95724	0.195	-2.84734		
0.1525	-1.24536	0.174	-1.95724	0.1955	-2.6693		
0.153	-0.889486	0.1745	-2.13524	0.196	-2.49127		
0.1535	-0.355761	0.175	-1.42331	0.1965	-2.49127		
0.154	0.355716	0.1755	-1.24536	0.197	-2.6693		
0.1545	0.711387	0.176	-1.24536	0.1975	-2.84734		
0.155	1.06701	0.1765	-0.889486	0.198	-2.84734		
0.1555	1.42259	0.177	-0.177875	0.1985	-3.02539		
0.156	1.42259	0.1775	-0.711566	0.199	-3.55962		

Gauge37_1 Time msec	Gauge37_1 Stress MPa	Gauge37_1 Time msec	Gauge37_1 Stress MPa	Gauge37_1 Time msec	Gauge37_1 Stress MPa	Gauge37_2 Time msec	Gauge37_2 Stress MPa	Gauge37_2 Time msec	Gauge37_2 Stress MPa
-0.01475	0	-0.004	0	0.00675	0	0.0345	0	0.056	0
-0.0145	0	-0.00375	0	0.007	-37.686	0.035	0.357772	0.0565	0
-0.01425	0	-0.0035	0	0.00725	-75.83	0.0355	0	0.057	0
-0.014	0	-0.00325	0	0.0075	-114.432	0.036	0	0.0575	-0.357817
-0.01375	0	-0.003	0	0.00775	-95.0738	0.0365	0	0.058	0
-0.0135	0	-0.00275	0	0.008	-56.7007	0.037	0	0.0585	0.357772
-0.01325	0	-0.0025	0	0.00825	-37.686	0.0375	0	0.059	0
-0.013	0	-0.00225	0	0.0085	-56.7007	0.038	0	0.0595	0
-0.01275	0	-0.002	0	0.00875	-56.7007	0.0385	0	0.06	0
-0.0125	0	-0.00175	0	0.009	-56.7007	0.039	0.357772	0.0605	-0.357817
-0.01225	0	-0.0015	0	0.00925	-56.7007	0.0395	0	0.061	0
-0.012	0	-0.00125	0	0.0095	-56.7007	0.04	0	0.0615	0
-0.01175	0	-0.001	0	0.00975	-95.0738	0.0405	0	0.062	0
-0.0115	0	-0.00075	0	0.01	0	0.041	0.357772	0.0625	0.357772
-0.01125	0	-0.0005	0	0.01025	-37.686	0.0415	0	0.063	0.715499
-0.011	0	-0.00025	0			0.042	0	0.0635	1.78841
-0.01075	0	0	0			0.0425	0.357772	0.064	2.86091
-0.0105	0	0.00025	37.2279			0.043	0.357772	0.0645	5.00471
-0.01025	0	0.0005	73.9978			0.0435	0.357772	0.065	7.86058
-0.01	0	0.00075	128.294			0.044	0	0.0655	11.4264
-0.00975	0	0.001	163.919			0.0445	0	0.066	14.2757
-0.0095	-18.7857	0.00125	199.085			0.045	0	0.0665	13.2076
-0.00925	0	0.0015	216.497			0.0455	0	0.067	9.64403
-0.009	0	0.00175	287.208			0.046	0	0.0675	5.36185
-0.00875	0	0.002	303.89			0.0465	0	0.068	1.43082
-0.0085	0	0.00225	357.704			0.047	0	0.0685	-1.43154
-0.00825	0	0.0025	459.063			0.0475	-0.357817	0.069	-1.43154
-0.008	0	0.00275	647.549			0.048	0	0.0695	-1.07359
-0.00775	0	0.003	752.033			0.0485	-0.357817	0.07	-1.78954
-0.0075	0	0.00325	779.074			0.049	-0.357817	0.0705	-3.5802
-0.00725	0	0.0035	752.033			0.0495	0	0.071	-5.73048
-0.007	0	0.00375	725.347			0.05	0	0.0715	-7.52362
-0.00675	0	0.004	725.347			0.0505	0	0.072	-8.60004
-0.0065	0	0.00425	725.347			0.051	0	0.0725	-8.60004
-0.00625	0	0.0045	673.091			0.0515	-0.357817	0.073	-9.67687
-0.006	0	0.00475	597.703			0.052	-0.357817	0.0735	-9.31789
-0.00575	0	0.005	503.348			0.0525	-0.357817	0.074	-10.0359
-0.0055	0	0.00525	376.848			0.053	-0.357817	0.0745	-8.95894
-0.00525	0	0.0055	233.794			0.0535	0	0.075	-8.95894
-0.005	0	0.00575	146.163			0.054	-0.357817	0.0755	-8.95894
-0.00475	0	0.006	92.211			0.0545	0	0.076	-8.60004
-0.0045	0	0.00625	73.9978			0.055	-0.357817	0.0765	-7.52362
-0.00425	0	0.0065	37.2279			0.0555	0	0.077	-6.80623

Gauge37_2 Time msec	Gauge37_2 Stress MPa	Gauge37_3 Time msec	Gauge37_3 Stress MPa	Gauge37_3 Time msec	Gauge37_3 Stress MPa	Gauge37_4 Time msec	Gauge37_4 Stress MPa	Gauge37_4 Time msec	Gauge37_4 Stress MPa
0.0775	-6.08902	0.027	0	0.0485	0	0.073	0	0.0945	0
0.078	-5.73048	0.0275	0	0.049	0	0.0735	0	0.095	0.357084
0.0785	-5.01354	0.028	0	0.0495	0	0.074	0	0.0955	0
0.079	-4.29678	0.0285	0	0.05	0	0.0745	0.357084	0.096	0
0.0795	-2.8638	0.029	0	0.0505	0	0.075	0	0.0965	0.357084
0.08	-1.43154	0.0295	-0.357129	0.051	0	0.0755	0.357084	0.097	0
0.0805	-0.715679	0.03	-0.357129	0.0515	0	0.076	0.714123	0.0975	0.357084
0.081	-0.357817	0.0305	-0.357129	0.052	-0.357129	0.0765	0	0.098	0
0.0815	0	0.031	-0.357129	0.0525	0	0.077	0	0.0985	0
0.082	-0.715679	0.0315	-0.357129	0.053	0	0.0775	0	0.099	0
0.0825	-1.43154	0.032	-0.357129	0.0535	0	0.078	0	0.0995	0
0.083	-2.8638	0.0325	-0.357129	0.054	-0.357129	0.0785	0.357084	0.1	0
0.0835	-4.29678	0.033	-0.357129	0.0545	-0.357129	0.079	0	0.1005	0
0.084	-6.08902	0.0335	0.357084	0.055	-0.357129	0.0795	0.357084	0.101	0
0.0845	-6.80623	0.034	0	0.0555	-0.357129	0.08	0.357084	0.1015	0
0.085	-7.1649	0.0345	0	0.056	0	0.0805	0.714123	0.102	0
0.0855	-7.1649	0.035	0	0.0565	-0.357129	0.081	0.357084	0.1025	-0.357129
0.086	-6.4476	0.0355	0	0.057	-0.357129	0.0815	0.714123	0.103	0
0.0865	-6.08902	0.036	0	0.0575	-0.357129	0.082	0.357084	0.1035	0
0.087	-6.08902	0.0365	0	0.058	0	0.0825	0.357084	0.104	0
0.0875	-5.37199	0.037	-0.357129	0.0585	-0.714303	0.083	0.357084	0.1045	0
0.088	-5.01354	0.0375	0	0.059	-0.357129	0.0835	0.357084	0.105	0
0.0885	-4.65514	0.038	0	0.0595	-0.357129	0.084	0.357084	0.1055	0
0.089	-5.01354	0.0385	0	0.06	-0.357129	0.0845	0.714123	0.106	-0.357129
0.0895	-4.65514	0.039	0	0.0605	-0.357129	0.085	0.357084	0.1065	0
0.09	-4.65514	0.0395	0	0.061	0	0.0855	0.714123	0.107	0
0.0905	-4.65514	0.04	0	0.0615	1.42807	0.086	0.357084	0.1075	0
0.091	-4.65514	0.0405	0	0.062	4.28204	0.0865	0.714123	0.108	0
0.0915	-5.01354	0.041	0	0.0625	7.13314	0.087	0.357084	0.1085	0
0.092	-5.37199	0.0415	0	0.063	7.13314	0.0875	0.357084	0.109	0
0.0925	-6.08902	0.042	0	0.0635	1.78497	0.088	0.357084	0.1095	0
0.093	-6.08902	0.0425	0			0.0885	0.357084	0.11	0
0.0935	-6.4476	0.043	0			0.089	0.357084	0.1105	-0.357129
0.094	-6.4476	0.0435	0			0.0895	0.357084	0.111	-0.357129
0.0945	-7.52362	0.044	0			0.09	0.357084	0.1115	-0.357129
0.095	-7.88238	0.0445	0			0.0905	0	0.112	-0.357129
0.0955	-8.24119	0.045	0			0.091	0.357084	0.1125	-0.714303
0.096	-8.24119	0.0455	0			0.0915	0.357084	0.113	-0.357129
0.0965	-8.95894	0.046	0			0.092	0	0.1135	-0.357129
0.097	-8.95894	0.0465	0			0.0925	0.357084	0.114	-0.357129
0.0975	-8.95894	0.047	0			0.093	0	0.1145	-0.357129
0.098	-8.95894	0.0475	-0.357129			0.0935	0.357084	0.115	-0.357129
0.0985	-8.95894	0.048	-0.357129			0.094	0	0.1155	-0.714303

Gauge37_4 Time msec	Gauge37_4 Stress MPa	Gauge37_5 Time msec	Gauge37_5 Stress MPa	Gauge37_5 Time msec	Gauge37_5 Stress MPa	Gauge37_5 Time msec	Gauge37_5 Stress MPa	Gauge37_5 Time msec	Gauge37_5 Stress MPa
0.116	-0.357129	0.069	0	0.0905	0	0.112	-0.71984	0.1335	-8.65004
0.1165	1.07112	0.0695	0	0.091	-0.359897	0.1125	0	0.134	-8.65004
0.117	2.14183	0.07	0	0.0915	0	0.113	0.719659	0.1345	-8.65004
0.1175	4.28204	0.0705	0	0.092	0	0.1135	1.43914	0.135	-8.2891
0.118	5.70795	0.071	0	0.0925	0	0.114	2.15843	0.1355	-8.2891
0.1185	6.77691	0.0715	0	0.093	0	0.1145	2.87755	0.136	-8.65004
0.119	4.63858	0.072	0	0.0935	0	0.115	3.23704	0.1365	-8.65004
		0.0725	0	0.094	0	0.1155	3.95588	0.137	-9.01103
		0.073	0	0.0945	0	0.116	5.03381	0.1375	-9.01103
		0.0735	0	0.095	0	0.1165	6.11132	0.138	-9.37206
		0.074	0	0.0955	0	0.117	7.18843	0.1385	-9.37206
		0.0745	0	0.096	-0.359897	0.1175	7.18843	0.139	-9.37206
		0.075	0	0.0965	0	0.118	5.03381	0.1395	-9.37206
		0.0755	0	0.097	-0.359897	0.1185	2.87755	0.14	-9.01103
		0.076	0	0.0975	-0.71984	0.119	1.07942	0.1405	-8.65004
		0.0765	0	0.098	-0.71984	0.1195	-0.71984	0.141	-8.65004
		0.077	0	0.0985	-0.359897	0.12	-3.96136	0.1415	-8.2891
		0.0775	0	0.099	-0.359897	0.1205	-8.2891	0.142	-8.2891
		0.078	0	0.0995	0	0.121	-10.8166	0.1425	-7.92821
		0.0785	0	0.1	-0.71984	0.1215	-12.2619	0.143	-7.92821
		0.079	0	0.1005	0	0.122	-13.3464	0.1435	-7.92821
		0.0795	0	0.101	-0.359897	0.1225	-14.793	0.144	-7.92821
		0.08	0	0.1015	-0.359897	0.123	-18.0504	0.1445	-7.92821
		0.0805	0	0.102	0	0.1235	-19.8616	0.145	-7.92821
		0.081	0	0.1025	-0.359897	0.124	-20.224	0.1455	-8.2891
		0.0815	0	0.103	-1.43986	0.1245	-20.5865	0.146	-8.2891
		0.082	0	0.1035	-1.07983	0.125	-20.224	0.1465	-7.56736
		0.0825	0	0.104	-2.16006	0.1255	-20.949	0.147	-7.56736
		0.083	0	0.1045	-2.52023	0.126	-20.5865	0.1475	-8.2891
		0.0835	0	0.105	-2.52023	0.1265	-20.224	0.148	-8.65004
		0.084	0	0.1055	-2.52023	0.127	-19.137	0.1485	-9.01103
		0.0845	0	0.106	-2.52023	0.1275	-18.0504	0.149	-9.73314
		0.085	0	0.1065	-3.96136	0.128	-16.9642	0.1495	-10.0943
		0.0855	0	0.107	-3.60101	0.1285	-15.8784	0.15	-10.0943
		0.086	0	0.1075	-3.96136	0.129	-15.5165	0.1505	-10.0943
		0.0865	0	0.108	-4.32176	0.1295	-14.4312	0.151	-10.8166
		0.087	0	0.1085	-3.96136	0.13	-13.708	0.1515	-10.4554
		0.0875	0	0.109	-3.96136	0.1305	-12.6234	0.152	-10.8166
		0.088	0	0.1095	-3.24071	0.131	-11.5392	0.1525	-10.4554
		0.0885	0	0.11	-3.24071	0.1315	-11.5392	0.153	-10.8166
		0.089	0	0.1105	-2.52023	0.132	-10.8166	0.1535	-10.4554
		0.0895	0	0.111	-2.16006	0.1325	-10.0943	0.154	-10.4554
		0.09	0	0.1115	-1.79994	0.133	-9.01103	0.1545	-10.4554

GaugeJ7_5	GaugeJ7_5	GaugeJ7_5	GaugeJ7_5	GaugeJ7_6	GaugeJ7_6	GaugeJ7_6	GaugeJ7_6	GaugeJ7_6	GaugeJ7_6
Time	Stress	Time	Stress	Time	Stress	Time	Stress	Time	Stress
msec	MPa	msec	MPa	msec	MPa	msec	MPa	msec	MPa
0.155	-10.0943	0.1765	-10.4554	0.065	0	0.0865	-0.179248	0.108	-0.537779
0.1555	-10.4554	0.177	-10.8166	0.0655	0.179237	0.087	0.358463	0.1085	-0.717061
0.156	-9.73314	0.1775	-10.8166	0.066	0	0.0875	0.179237	0.109	-0.717061
0.1565	-9.37206	0.178	-10.8166	0.0665	0	0.088	0.179237	0.1095	-0.717061
0.157	-9.01103	0.1785	-11.1779	0.067	0.179237	0.0885	0	0.11	-0.896354
0.1575	-8.65004	0.179	-11.1779	0.0675	0.179237	0.089	-0.179248	0.1105	-0.896354
0.158	-8.2891	0.1795	-11.1779	0.068	0.179237	0.0895	0	0.111	-0.896354
0.1585	-8.65004	0.18	-11.5392	0.0685	0	0.09	0	0.1115	-0.717061
0.159	-8.2891	0.1805	-11.5392	0.069	0	0.0905	0	0.112	-0.896354
0.1595	-8.2891	0.181	-11.5392	0.0695	0	0.091	0	0.1125	-0.896354
0.16	-8.65004	0.1815	-11.1779	0.07	-0.179248	0.0915	0	0.113	-1.07566
0.1605	-8.65004	0.182	-11.5392	0.0705	0	0.092	0	0.1135	-1.07566
0.161	-8.65004	0.1825	-11.5392	0.071	0	0.0925	-0.179248	0.114	-1.25497
0.1615	-9.01103	0.183	-11.1779	0.0715	0	0.093	0	0.1145	-1.07566
0.162	-9.73314	0.1835	-11.1779	0.072	-0.179248	0.0935	0	0.115	-1.07566
0.1625	-9.73314	0.184	-10.8166	0.0725	-0.179248	0.094	0	0.1155	-1.07566
0.163	-10.0943	0.1845	-10.4554	0.073	0	0.0945	0	0.116	-1.25497
0.1635	-10.4554	0.185	-10.0943	0.0735	-0.179248	0.095	0	0.1165	-1.25497
0.164	-10.4554	0.1855	-9.37206	0.074	0	0.0955	0	0.117	-1.25497
0.1645	-10.8166	0.186	-9.37206	0.0745	-0.179248	0.096	0	0.1175	-1.4343
0.165	-10.8166	0.1865	-9.01103	0.075	-0.179248	0.0965	-0.179248	0.118	-1.61364
0.1655	-10.8166	0.187	-8.65004	0.0755	-0.358508	0.097	0	0.1185	-1.79299
0.166	-10.8166	0.1875	-8.2891	0.076	0	0.0975	0	0.119	-1.97235
0.1665	-10.8166	0.188	-7.92821	0.0765	-0.179248	0.098	0.179237	0.1195	-2.33111
0.167	-10.8166	0.1885	-8.65004	0.077	-0.179248	0.0985	0.179237	0.12	-2.33111
0.1675	-10.8166	0.189	-9.01103	0.0775	0	0.099	0	0.1205	-2.68991
0.168	-11.1779	0.1895	-9.73314	0.078	0	0.0995	-0.179248	0.121	-3.40765
0.1685	-11.5392	0.19	-9.73314	0.0785	0	0.1	0	0.1215	-3.76658
0.169	-11.5392	0.1905	-10.0943	0.079	-0.179248	0.1005	0	0.122	-3.76658
0.1695	-11.5392	0.191	-10.4554	0.0795	0	0.101	0	0.1225	-4.12557
0.17	-11.1779	0.1915	-10.8166	0.08	0	0.1015	-0.179248	0.123	-4.66412
0.1705	-11.5392	0.192	-11.1779	0.0805	0	0.102	-0.179248	0.1235	-5.02322
0.171	-11.5392	0.1925	-11.5392	0.081	0.179237	0.1025	0	0.124	-5.20278
0.1715	-11.5392	0.193	-11.9005	0.0815	0.179237	0.103	-0.179248	0.1245	-5.20278
0.172	-11.5392	0.1935	-11.9005	0.082	0	0.1035	-0.358508	0.125	-5.20278
0.1725	-11.1779	0.194	-11.9005	0.0825	0.179237	0.104	-0.358508	0.1255	-4.84366
0.173	-11.1779	0.1945	-12.2619	0.083	0.179237	0.1045	-0.179248	0.126	-4.66412
0.1735	-11.5392	0.195	-11.1779	0.0835	0.179237	0.105	-0.179248	0.1265	-4.30507
0.174	-11.1779	0.1955	-11.5392	0.084	0.179237	0.1055	-0.537779	0.127	-3.40765
0.1745	-11.1779	0.196	-11.9005	0.0845	0	0.106	-0.717061	0.1275	-2.86933
0.175	-11.1779	0.1965	-12.9849	0.085	0	0.1065	-0.717061	0.128	-2.33111
0.1755	-10.8166	0.197	-13.3464	0.0855	0	0.107	-0.537779	0.1285	-1.4343
0.176	-10.8166	0.1975	-13.708	0.086	0.358463	0.1075	-0.717061	0.129	-0.537779

GaugeJ7_6	GaugeJ7_6	GaugeJ7_6	GaugeJ7_6	GaugeJ7_6	GaugeJ7_6
Time	Stress	Time	Stress	Time	Stress
msec	MPa	msec	MPa	msec	MPa
0.1295	0.537677	0.151	-1.25497	0.1725	3.04549
0.13	1.25442	0.1515	-2.15172	0.173	4.1196
0.1305	2.1501	0.152	-2.5105	0.1735	5.19329
0.131	3.22454	0.1525	-3.04876	0.174	5.90886
0.1315	3.94061	0.153	-3.2282	0.1745	6.80307
0.132	4.65649	0.1535	-3.58711	0.175	6.98188
0.1325	5.19329	0.154	-3.58711	0.1755	7.16068
0.133	5.5511	0.1545	-3.58711	0.176	6.44542
0.1335	5.90886	0.155	-3.58711	0.1765	5.72999
0.134	5.90886	0.1555	-3.76658	0.177	4.65649
0.1345	5.5511	0.156	-3.2282	0.1775	3.22454
0.135	5.19329	0.1565	-2.15172	0.178	1.43358
0.1355	5.01437	0.157	-1.07566	0.1785	0.179237
0.136	4.1196	0.1575	-0.179248	0.179	-1.61364
0.1365	3.5826	0.158	0.896072	0.1795	-3.04876
0.137	2.86644	0.1585	1.43358	0.18	-4.30507
0.1375	1.79186	0.159	2.1501	0.1805	-5.02322
0.138	0.896072	0.1595	2.68737	0.181	-5.02322
0.1385	-0.179248	0.16	3.04549	0.1815	-4.30507
0.139	-1.25497	0.1605	3.22454	0.182	-2.5105
0.1395	-2.33111	0.161	3.40357	0.1825	-0.358508
0.14	-3.04876	0.1615	3.40357	0.183	3.40357
0.1405	-3.76658	0.162	3.5826	0.1835	5.90886
0.141	-4.84366	0.1625	3.5826	0.184	5.72999
0.1415	-5.20278	0.163	3.76161		
0.142	-5.56194	0.1635	3.40357		
0.1425	-5.38236	0.164	3.22454		
0.143	-5.38236	0.1645	3.22454		
0.1435	-5.38236	0.165	2.50829		
0.144	-4.84366	0.1655	2.1501		
0.1445	-3.94607	0.166	1.61273		
0.145	-2.86933	0.1665	0.896072		
0.1455	-1.97235	0.167	0.179237		
0.146	-0.537779	0.1675	-0.537779		
0.1465	0.537677	0.168	-0.896354		
0.147	1.43358	0.1685	-1.25497		
0.1475	1.97099	0.169	-1.61364		
0.148	2.1501	0.1695	-1.61364		
0.1485	1.79186	0.17	-1.4343		
0.149	1.61273	0.1705	-0.537779		
0.1495	0.358463	0.171	0.179237		
0.15	0.358463	0.1715	1.25442		
0.1505	-0.717061	0.172	2.1501		



GaugeJ8_1 Time msec	GaugeJ8_1 Stress MPa	GaugeJ8_1 Time msec	GaugeJ8_1 Stress MPa	GaugeJ8_1 Time msec	GaugeJ8_1 Stress MPa	GaugeJ8_1 Time msec	GaugeJ8_1 Stress MPa	GaugeJ8_1 Time msec	GaugeJ8_1 Stress MPa
-0.029	19.0988	-0.01825	0	-0.0075	0	0.00325	748.914	0.014	-3367.86
-0.02875	0	-0.018	0	-0.00725	0	0.0035	721.482	0.01425	-3478.74
-0.0285	0	-0.01775	0	-0.007	0	0.00375	667.831	0.0145	-3478.74
-0.02825	0	-0.0175	0	-0.00675	0	0.004	565.779	0.01475	-3367.86
-0.028	0	-0.01725	0	-0.0065	0	0.00425	427.567	0.015	-3367.86
-0.02775	0	-0.017	0	-0.00625	0	0.0045	239.148	0.01525	-2049.37
-0.0275	0	-0.01675	56.945	-0.006	0	0.00475	167.672	0.0155	-1894.5
-0.02725	0	-0.0165	75.6924	-0.00575	0	0.005	149.511	0.01575	-1820.01
-0.027	0	-0.01625	0	-0.0055	0	0.00525	167.672	0.016	-969.825
-0.02675	0	-0.016	-19.2159	-0.00525	0	0.0055	131.232	0.01625	-77.5666
-0.0265	19.0988	-0.01575	-19.2159	-0.005	0	0.00575	94.3227	0.0165	38.0805
-0.02625	19.0988	-0.0155	0	-0.00475	0	0.006	-1970.95	0.01675	38.0805
-0.026	0	-0.01525	0	-0.0045	0	0.00625	-3478.74	0.017	56.945
-0.02575	0	-0.015	0	-0.00425	0	0.0065	-3367.86	0.01725	0
-0.0255	0	-0.01475	0	-0.004	0	0.00675	-3367.86	0.0175	-38.549
-0.02525	0	-0.0145	0	-0.00375	0	0.007	-3367.86	0.01775	-77.5666
-0.025	0	-0.01425	0	-0.0035	0	0.00725	-3367.86	0.018	-77.5666
-0.02475	0	-0.014	0	-0.00325	0	0.0075	-3367.86	0.01825	-157.007
-0.0245	0	-0.01375	0	-0.003	0	0.00775	-3478.74	0.0185	-97.2511
-0.02425	19.0988	-0.0135	0	-0.00275	0	0.008	-3478.74	0.01875	-77.5666
-0.024	0	-0.01325	0	-0.0025	0	0.00825	-3367.86	0.019	-77.5666
-0.02375	0	-0.013	0	-0.00225	0	0.0085	-3478.74	0.01925	-77.5666
-0.0235	0	-0.01275	0	-0.002	0	0.00875	-3367.86	0.0195	-57.9992
-0.02325	0	-0.0125	0	-0.00175	0	0.009	-3478.74	0.01975	-77.5666
-0.023	0	-0.01225	0	-0.0015	0	0.00925	-3478.74	0.02	-1351.39
-0.02275	0	-0.012	0	-0.00125	0	0.0095	-3367.86	0.02025	-3478.74
-0.0225	0	-0.01175	0	-0.001	0	0.00975	-3478.74	0.0205	-3478.74
-0.02225	0	-0.0115	0	-0.00075	0	0.01	-3478.74	0.02075	-3367.86
-0.022	0	-0.01125	0	-0.0005	0	0.01025	-3367.86	0.021	-3367.86
-0.02175	0	-0.011	0	-0.00025	0	0.0105	-3367.86	0.02125	-3367.86
-0.0215	0	-0.01075	0	0	0	0.01075	-3367.86	0.0215	-3478.74
-0.02125	0	-0.0105	0	0.00025	38.0805	0.011	-3367.86	0.02175	-3478.74
-0.021	0	-0.01025	0	0.0005	112.836	0.01125	-3478.74	0.022	-3478.74
-0.02075	0	-0.01	0	0.00075	185.717	0.0115	-3478.74	0.02225	-3478.74
-0.0205	0	-0.00975	0	0.001	239.148	0.01175	-3478.74	0.0225	-3478.74
-0.02025	0	-0.0095	0	0.00125	328.077	0.012	-3478.74	0.02275	-3478.74
-0.02	0	-0.00925	0	0.0015	406.457	0.01225	-3478.74	0.023	-3478.74
-0.01975	0	-0.009	0	0.00175	615.892	0.0125	-3478.74	0.02325	-3478.74
-0.0195	0	-0.00875	0	0.002	804.921	0.01275	-3367.86	0.0235	-3478.74
-0.01925	0	-0.0085	0	0.00225	891.586	0.013	-3478.74	0.02375	-3367.86
-0.019	0	-0.00825	0	0.0025	891.586	0.01325	-3367.86	0.024	-3478.74
-0.01875	0	-0.008	0	0.00275	833.47	0.0135	-3478.74	0.02425	-3367.86
-0.0185	0	-0.00775	0	0.003	804.921	0.01375	-3478.74	0.0245	-3367.86
GaugeJ8_1 Time msec	GaugeJ8_1 Stress MPa	GaugeJ8_2 Time msec	GaugeJ8_2 Stress MPa	GaugeJ8_2 Time msec	GaugeJ8_2 Stress MPa	GaugeJ8_2 Time msec	GaugeJ8_2 Stress MPa	GaugeJ8_2 Time msec	GaugeJ8_2 Stress MPa
0.02475	-3478.74	0.0275	0	0.049	-0.347766	0.0705	-16.7422	0.092	-17.092
0.025	-3478.74	0.028	-0.347766	0.0495	-0.347766	0.071	-17.092	0.0925	-17.4419
0.02525	-3367.86	0.0285	-0.695576	0.05	-0.347766	0.0715	-17.7919	0.093	-17.4419
0.0255	-3367.86	0.029	0	0.0505	0	0.072	-17.7919	0.0935	-17.092
0.02575	-3478.74	0.0295	0	0.051	0	0.0725	-17.092	0.094	-17.092
0.026	-3478.74	0.03	0	0.0515	0	0.073	-16.7422	0.0945	-16.3923
0.02625	-3478.74	0.0305	0	0.052	0	0.0735	-17.4419	0.095	-16.3923
0.0265	-3367.86	0.031	0	0.0525	0	0.074	-18.1419	0.0955	-16.3923
0.02675	-3478.74	0.0315	0	0.053	0	0.0745	-18.842	0.096	-17.4419
0.027	-3478.74	0.032	0	0.0535	0	0.075	-19.1922	0.0965	-17.092
0.02725	-3367.86	0.0325	0	0.054	0.347722	0.0755	-19.5423	0.097	-16.7422
0.0275	-3367.86	0.033	0	0.0545	0.347722	0.076	-19.8925	0.0975	-16.7422
0.02775	-3478.74	0.0335	0	0.055	0	0.0765	-20.2428	0.098	-17.7919
0.028	-3478.74	0.034	0	0.0555	0	0.077	-21.9948	0.0985	-17.7919
		0.0345	0	0.056	0	0.0775	-22.3453	0.099	-18.842
		0.035	0	0.0565	0.347722	0.078	-20.9435	0.0995	-18.842
		0.0355	0.347722	0.057	0	0.0785	-20.9435	0.1	-19.1922
		0.036	0.347722	0.0575	0.347722	0.079	-20.9435	0.1005	-19.5423
		0.0365	0	0.058	0.347722	0.0795	-21.2939	0.101	-19.8925
		0.037	0.347722	0.0585	0.347722	0.08	-20.9435	0.1015	-20.2428
		0.0375	0.347722	0.059	0.347722	0.0805	-20.2428	0.102	-20.2428
		0.038	0	0.0595	1.04304	0.081	-19.5423	0.1025	-20.5931
		0.0385	0	0.06	4.16978	0.0815	-19.5423	0.103	-20.2428
		0.039	0.347722	0.0605	12.8366	0.082	-19.5423	0.1035	-19.8925
		0.0395	0.347722	0.061	16.6413	0.0825	-19.5423	0.104	-19.8925
		0.04	0	0.0615	10.0662	0.083	-18.842	0.1045	-19.5423
		0.0405	-0.347766	0.062	1.73817	0.0835	-17.7919	0.105	-19.5423
		0.041	-0.347766	0.0625	-4.87271	0.084	-17.092	0.1055	-19.1922
		0.0415	-0.347766	0.063	-6.96364	0.0845	-16.3923	0.106	-19.1922
		0.042	0	0.0635	-6.26649	0.085	-15.3431	0.1065	-19.1922
		0.0425	0	0.064	-6.96364	0.0855	-14.6439	0.107	-18.842
		0.043	-0.347766	0.0645	-7.66097	0.086	-13.9448	0.1075	-18.4919
		0.0435	0	0.065	-6.26649	0.0865	-12.8965	0.108	-18.1419
		0.044	-0.695576	0.0655	-6.96364	0.087	-12.8965	0.1085	-18.1419
		0.0445	0	0.066	-9.754	0.0875	-12.8965	0.109	-18.1419
		0.045	0	0.0665	-12.8965	0.088	-14.2943	0.1095	-17.7919
		0.0455	-0.347766	0.067	-14.2943	0.0885	-15.6928	0.11	-17.7919
		0.046	-0.347766	0.0675	-15.6928	0.089	-16.3923	0.1105	-17.4419
		0.0465	-0.347766	0.068	-16.3923	0.0895	-16.7422	0.111	-17.4419
		0.047	0	0.0685	-17.092	0.09	-16.7422	0.1115	-17.4419
		0.0475	0	0.069	-17.7919	0.0905	-16.7422	0.112	-18.1419
		0.048	-0.347766	0.0695	-17.7919	0.091	-17.092	0.1125	-18.4919
		0.0485	-0.347766	0.07	-17.4419	0.0915	-17.092	0.113	-18.842

Gauge38_2 Time msec	Gauge38_2 Stress MPa	Gauge38_2 Time msec	Gauge38_2 Stress MPa	Gauge38_2 Time msec	Gauge38_2 Stress MPa	Gauge38_3 Time msec	Gauge38_3 Stress MPa	Gauge38_3 Time msec	Gauge38_3 Stress MPa
0.1135	-19.1922	0.135	-12.1979	0.1565	-13.5953	0.041	0	0.0625	0.34578
0.114	-19.8925	0.1355	-11.1502	0.157	-13.5953	0.0415	0	0.063	-5.19192
0.1145	-20.2428	0.136	-11.1502	0.1575	-13.5953	0.042	0.34578	0.0635	-9.35251
0.115	-19.8925	0.1365	-10.8011	0.158	-13.5953	0.0425	0	0.064	-11.7824
0.1155	-19.5423	0.137	-10.8011	0.1585	-13.5953	0.043	0.34578	0.0645	-14.2145
0.116	-19.8925	0.1375	-10.103	0.159	-13.9448	0.0435	0.34578	0.065	-15.6052
0.1165	-19.8925	0.138	-10.103	0.1595	-14.6439	0.044	0.34578	0.0655	-15.6052
0.117	-20.5931	0.1385	-9.40505	0.16	-14.2943	0.0445	0.34578	0.066	-17.3445
0.1175	-21.2939	0.139	-9.754	0.1605	-14.2943	0.045	0.34578	0.0665	-20.4781
0.118	-21.2939	0.1395	-9.40505	0.161	-13.9448	0.0455	0.34578	0.067	-23.2664
0.1185	-21.2939	0.14	-10.103	0.1615	-14.6439	0.046	0.34578	0.0675	-25.0106
0.119	-20.9435	0.1405	-9.05615	0.162	-14.2943	0.0465	0.34578	0.068	-25.3595
0.1195	-20.5931	0.141	-10.103	0.1625	-13.9448	0.047	0.34578	0.0685	-26.4067
0.12	-20.5931	0.1415	-9.05615	0.163	-13.5953	0.0475	0	0.069	-26.7558
0.1205	-20.5931	0.142	-10.103	0.1635	-13.2459	0.048	0	0.0695	-27.105
0.121	-20.2428	0.1425	-11.4994	0.164	-13.5953	0.0485	0	0.07	-27.4542
0.1215	-20.2428	0.143	-11.8486	0.1645	-13.5953	0.049	0	0.0705	-28.1528
0.122	-19.8925	0.1435	-11.8486	0.165	-13.2459	0.0495	0	0.071	-27.8035
0.1225	-19.1922	0.144	-11.8486	0.1655	-12.8965	0.05	0	0.0715	-28.1528
0.123	-18.842	0.1445	-12.1979	0.166	-12.8965	0.0505	0.34578	0.072	-28.1528
0.1235	-19.1922	0.145	-12.5472	0.1665	-12.5472	0.051	0.34578	0.0725	-27.4542
0.124	-19.5423	0.1455	-12.8965	0.167	-11.4994	0.0515	0.34578	0.073	-26.4067
0.1245	-19.8925	0.146	-12.8965	0.1675	-10.8011	0.052	0.34578	0.0735	-25.0106
0.125	-19.8925	0.1465	-13.2459	0.168	-10.452	0.0525	0.34578	0.074	-22.5691
0.1255	-19.5423	0.147	-13.5953	0.1685	-9.05615	0.053	0.34578	0.0745	-20.4781
0.126	-18.842	0.1475	-12.8965	0.169	-8.35847	0.0535	0.34578	0.075	-20.1297
0.1265	-17.7919	0.148	-13.9448	0.1695	-8.0097	0.054	0.34578	0.0755	-21.5234
0.127	-17.092	0.1485	-14.2943	0.17	-7.66097	0.0545	0.34578	0.076	-23.964
0.1275	-16.3923	0.149	-13.9448	0.1705	-7.31228	0.055	0.34578	0.0765	-27.4542
0.128	-16.0426	0.1495	-13.2459	0.171	-6.96364	0.0555	0.34578	0.077	-30.5991
0.1285	-15.6928	0.15	-13.9448	0.1715	-6.66364	0.056	0.34578	0.0775	-32.6977
0.129	-15.6928	0.1505	-13.9448	0.172	-7.66097	0.0565	0.34578	0.078	-34.0976
0.1295	-15.6928	0.151	-14.2943	0.1725	-7.66097	0.057	0	0.0785	-34.4477
0.13	-14.9935	0.1515	-13.9448	0.173	-8.70729	0.0575	0.34578	0.079	-34.7979
0.1305	-14.9935	0.152	-13.2459	0.1735	-8.70729	0.058	0.34578	0.0795	-34.7979
0.131	-14.9935	0.1525	-13.5953	0.174	-11.4994	0.0585	0.34578	0.08	-34.0976
0.1315	-14.9935	0.153	-13.5953	0.1745	-12.1979	0.059	0.34578	0.0805	-33.3976
0.132	-14.6439	0.1535	-13.5953	0.175	-13.2459	0.0595	1.03721	0.081	-33.0476
0.1325	-14.2943	0.154	-13.2459	0.1755	-14.9935	0.06	2.76502	0.0815	-33.0476
0.133	-13.9448	0.1545	-13.9448	0.176	-16.7422	0.0605	6.21737	0.082	-31.998
0.1335	-13.9448	0.155	-13.9448			0.061	12.4206	0.0825	-31.2985
0.134	-13.2459	0.1555	-13.5953			0.0615	12.7648	0.083	-30.5991
0.1345	-12.5472	0.156	-13.5953			0.062	5.52725	0.0835	-29.8999

Gauge38_3 Time msec	Gauge38_3 Stress MPa	Gauge38_3 Time msec	Gauge38_3 Stress MPa	Gauge38_3 Time msec	Gauge38_3 Stress MPa	Gauge38_3 Time msec	Gauge38_3 Stress MPa	Gauge38_3 Time msec	Gauge38_3 Stress MPa
0.084	-29.2009	0.1055	-32.6977	0.127	-21.1749	0.1485	-20.4781	0.17	-20.4781
0.0845	-28.1528	0.106	-33.0476	0.1275	-20.1297	0.149	-21.1749	0.1705	-21.1749
0.085	-27.8035	0.1065	-33.0476	0.128	-19.0849	0.1495	-20.8265	0.171	-21.8719
0.0855	-27.4542	0.107	-33.0476	0.1285	-19.0849	0.15	-15.6052	0.1715	-21.8719
0.086	-26.7558	0.1075	-33.0476	0.129	-18.7368	0.1505	-19.0849	0.172	-22.5691
0.0865	-26.4067	0.108	-32.6977	0.1295	-18.7368	0.151	-17.6925	0.1725	-22.9177
0.087	-26.4067	0.1085	-32.6977	0.13	-18.0405	0.1515	-21.5234	0.173	-21.6152
0.0875	-26.0576	0.109	-32.6977	0.1305	-18.3886	0.152	-21.8719	0.1735	-19.7814
0.088	-25.7085	0.1095	-32.3478	0.131	-18.7368	0.1525	-23.2664	0.174	-27.8035
0.0885	-26.4067	0.11	-32.3478	0.1315	-19.0849	0.153	-22.9177	0.1745	-25.3595
0.089	-26.0576	0.1105	-32.3478	0.132	-19.0849	0.1535	-23.2664	0.175	-19.7814
0.0895	-26.4067	0.111	-33.0476	0.1325	-20.1297	0.154	-22.9177	0.1755	-22.5691
0.09	-26.4067	0.1115	-33.3976	0.133	-21.1749	0.1545	-30.5991	0.176	-20.8265
0.0905	-26.7558	0.112	-32.6977	0.1335	-21.8719	0.155	-25.7085	0.1765	-23.964
0.091	-27.8035	0.1125	-32.3478	0.134	-22.9177	0.1555	-23.6152		
0.0915	-27.8035	0.113	-31.6482	0.1345	-23.964	0.156	-22.9177		
0.092	-27.8035	0.1135	-31.2985	0.135	-23.964	0.1565	-22.5691		
0.0925	-28.1528	0.114	-30.9488	0.1355	-24.6617	0.157	-21.8719		
0.093	-27.8035	0.1145	-30.2495	0.136	-24.6617	0.1575	-22.2205		
0.0935	-27.4542	0.115	-29.2009	0.1365	-24.6617	0.158	-22.5691		
0.094	-27.8035	0.1155	-28.8515	0.137	-24.6617	0.1585	-22.5691		
0.0945	-27.4542	0.116	-28.5021	0.1375	-24.6617	0.159	-22.2205		
0.095	-27.4542	0.1165	-28.1528	0.138	-24.6617	0.1595	-22.2205		
0.0955	-27.4542	0.117	-27.8035	0.1385	-24.6617	0.16	-21.8719		
0.096	-27.8035	0.1175	-27.8035	0.139	-24.6617	0.1605	-21.8719		
0.0965	-27.4542	0.118	-28.1528	0.1395	-24.3128	0.161	-21.8719		
0.097	-26.7558	0.1185	-27.8035	0.14	-33.0476	0.1615	-21.8719		
0.0975	-27.4542	0.119	-27.4542	0.1405	-25.7085	0.162	-21.8719		
0.098	-27.8035	0.1195	-27.4542	0.141	-23.964	0.1625	-21.8719		
0.0985	-27.4542	0.12	-27.4542	0.1415	-22.5691	0.163	-21.8719		
0.099	-28.1528	0.1205	-27.4542	0.142	-21.5234	0.1635	-21.5234		
0.0995	-28.8515	0.121	-27.4542	0.1425	-21.1749	0.164	-21.1749		
0.1	-29.2009	0.1215	-27.4542	0.143	-20.4781	0.1645	-20.4781		
0.1005	-30.2495	0.122	-27.8035	0.1435	-20.1297	0.165	-20.8265		
0.101	-30.9488	0.1225	-27.4542	0.144	-20.1297	0.1655	-20.4781		
0.1015	-31.2985	0.123	-27.105	0.1445	-19.4332	0.166	-19.7814		
0.102	-31.6482	0.1235	-27.105	0.145	-19.4332	0.1665	-19.4332		
0.1025	-31.6482	0.124	-27.105	0.1455	-19.0849	0.167	-18.7368		
0.103	-31.6482	0.1245	-26.4067	0.146	-19.0849	0.1675	-19.0849		
0.1035	-31.6482	0.125	-25.7085	0.1465	-19.0849	0.168	-19.0849		
0.104	-31.6482	0.1255	-25.3595	0.147	-19.0849	0.1685	-19.0849		
0.1045	-31.998	0.126	-23.964	0.1475	-19.4332	0.169	-19.4332		
0.105	-31.998	0.1265	-22.5691	0.148	-17.6925	0.1695	-19.7814		

Gauge38_4 Time msec	Gauge38_4 Stress MPa	Gauge38_4 Time msec	Gauge38_4 Stress MPa	Gauge38_4 Time msec	Gauge38_4 Stress MPa	Gauge38_5 Time msec	Gauge38_5 Stress MPa	Gauge38_5 Time msec	Gauge38_5 Stress MPa
0.0765	0	0.098	0	0.1195	1.05289	0.0905	-0.347766	0.112	0.347722
0.077	-0.351053	0.0985	0	0.12	3.15749	0.091	0	0.1125	0.347722
0.0775	-1.05329	0.099	0	0.1205	7.71198	0.0915	0	0.113	0
0.078	0.351009	0.0995	0	0.121	11.2104	0.092	0.347722	0.1135	0.347722
0.0785	1.05289	0.1	0.351009	0.1215	10.8607	0.0925	0	0.114	0
0.079	0.701973	0.1005	0	0.122	7.01178	0.093	0	0.1145	0
0.0795	0.351009	0.101	0.351009	0.1225	3.5081	0.0935	0.347722	0.115	0
0.08	0.351009	0.1015	0.701973	0.123	1.05289	0.094	0.347722	0.1155	0.347722
0.0805	1.05289	0.102	0.701973	0.1235	-1.05329	0.0945	0	0.116	0
0.081	1.05289	0.1025	0.701973	0.124	-4.21555	0.095	0	0.1165	0
0.0815	0.701973	0.103	0.701973	0.1245	-7.73338	0.0955	0.695401	0.117	0
0.082	0.701973	0.1035	0.701973	0.125	-9.84619	0.096	0.695401	0.1175	0
0.0825	0.701973	0.104	0.701973	0.1255	-10.5508	0.0965	0	0.118	0
0.083	1.05289	0.1045	0.351009	0.126	-10.9032	0.097	0	0.1185	0
0.0835	0.701973	0.105	1.05289	0.1265	-10.1985	0.0975	0	0.119	0
0.084	0.701973	0.1055	0.701973	0.127	-10.5508	0.098	0.695401	0.1195	0
0.0845	0.701973	0.106	0.701973	0.1275	-10.9032	0.0985	0.347722	0.12	0
0.085	0.701973	0.1065	1.05289	0.128	-10.9032	0.099	0.347722	0.1205	0
0.0855	1.05289	0.107	0.701973	0.1285	-11.2556	0.0995	0.347722	0.121	0
0.086	1.05289	0.1075	1.05289	0.129	-11.2556	0.1	0.695401	0.1215	0.347722
0.0865	0.701973	0.108	0.701973	0.1295	-10.9032	0.1005	0.347722	0.122	0.347722
0.087	0.701973	0.1085	0.701973	0.13	-10.1985	0.101	0.695401	0.1225	2.78055
0.0875	0.701973	0.109	0.701973	0.1305	-9.84619	0.1015	0.347722	0.123	5.90532
0.088	0.701973	0.1095	0.701973	0.131	-9.84619	0.102	0.347722	0.1235	8.67992
0.0885	0.701973	0.11	0.351009	0.1315	-10.5508	0.1025	0.347722	0.124	10.759
0.089	0.701973	0.1105	0.701973	0.132	-10.9032	0.103	0.347722	0.1245	10.0662
0.0895	0	0.111	0.351009	0.1325	-10.9032	0.1035	0.695401	0.125	6.94612
0.09	0	0.1115	0.351009	0.133	-11.2556	0.104	0.347722	0.1255	1.04304
0.0905	0.351009	0.112	0.351009	0.1335	-11.6081	0.1045	0.347722	0.126	-5.22109
0.091	0	0.1125	0	0.134	-11.6081	0.105	0.695401	0.1265	-8.35847
0.0915	0	0.113	0	0.1345	-11.6081	0.1055	0.695401	0.127	-8.0097
0.092	0	0.1135	0.351009	0.135	-11.9606	0.106	0.347722	0.1275	-6.61504
0.0925	-0.351053	0.114	0	0.1355	-13.0184	0.1065	0.347722	0.128	-5.22109
0.093	0	0.1145	0	0.136	-16.5473	0.107	0.347722	0.1285	-4.17608
0.0935	0	0.115	0	0.1365	-16.5473	0.1075	0.347722	0.129	-3.82783
0.094	0	0.1155	0			0.108	0.347722	0.1295	-4.17608
0.0945	0	0.116	0			0.1085	0.347722	0.13	-4.17608
0.095	0	0.1165	0			0.109	0.347722	0.1305	-3.82783
0.0955	0	0.117	0			0.1095	0.347722	0.131	-3.47963
0.096	0	0.1175	0			0.11	0.347722	0.1315	-1.73927
0.0965	0	0.118	0			0.1105	0.347722	0.132	-1.39133
0.097	0	0.1185	0			0.111	0.347722	0.1325	-1.39133
0.0975	0	0.119	0.351009			0.1115	0.347722	0.133	-1.39133

Gauge38_5 Time msec	Gauge38_5 Stress MPa	Gauge38_5 Time msec	Gauge38_5 Stress MPa	Gauge38_5 Time msec	Gauge38_5 Stress MPa	Gauge38_5 Time msec	Gauge38_5 Stress MPa	Gauge38_5 Time msec	Gauge38_5 Stress MPa
0.1335	-2.43528	0.155	-0.347766	0.1765	-5.91798	0.198	-7.31228	0.2195	-10.8011
0.134	-1.39133	0.1555	-1.04343	0.177	-5.91798	0.1985	-7.66097	0.22	-10.452
0.1345	0.347722	0.156	-1.39133	0.1775	-3.47963	0.199	-8.35847	0.2205	-10.103
0.135	1.73817	0.1565	-1.73927	0.178	-3.47963	0.1995	-8.70729	0.221	-9.754
0.1355	2.78055	0.157	-2.08725	0.1785	-3.47963	0.2	-9.05615	0.2215	-9.40505
0.136	3.47525	0.1575	-2.08725	0.179	-3.47963	0.2005	-9.05615		
0.1365	3.82254	0.158	-2.08725	0.1795	-3.13147	0.201	-9.40505		
0.137	3.82254	0.1585	-2.43528	0.18	-3.82783	0.2015	-9.40505		
0.1375	3.82254	0.159	-2.43528	0.1805	-3.13147	0.202	-9.40505		
0.138	4.16978	0.1595	-2.08725	0.181	-3.13147	0.2025	-8.35847		
0.1385	3.82254	0.16	-2.08725	0.1815	-3.82783	0.203	-8.35847		
0.139	4.16978	0.1605	-2.08725	0.182	-3.82783	0.2035	-8.0097		
0.1395	3.82254	0.161	-2.43528	0.1825	-3.13147	0.204	-8.35847		
0.14	3.47525	0.1615	-1.73927	0.183	-3.47963	0.2045	-8.35847		
0.1405	3.82254	0.162	-1.39133	0.1835	-2.78335	0.205	-8.35847		
0.141	4.16978	0.1625	-1.04343	0.184	-3.47963	0.2055	-8.35847		
0.1415	3.12792	0.163	-1.39133	0.1845	-3.47963	0.206	-8.70729		
0.142	2.78055	0.1635	-1.39133	0.185	-3.82783	0.2065	-8.0097		
0.1425	2.43314	0.164	-1.39133	0.1855	-4.52437	0.207	-8.0097		
0.143	2.78055	0.1645	-1.73927	0.186	-4.87271	0.2075	-8.35847		
0.1435	1.73817	0.165	-1.39133	0.1865	-4.87271	0.208	-7.66097		
0.144	1.39063	0.1655	-1.73927	0.187	-5.91798	0.2085	-8.0097		
0.1445	0	0.166	-1.73927	0.1875	-4.52437	0.209	-8.70729		
0.145	0	0.1665	-2.43528	0.188	-4.17608	0.2095	-9.40505		
0.1455	-0.347766	0.167	-2.78335	0.1885	-4.17608	0.21	-9.05615		
0.146	-0.347766	0.1675	-2.43528	0.189	-3.82783	0.2105	-9.40505		
0.1465	-1.04343	0.168	-2.78335	0.1895	-4.17608	0.211	-9.40505		
0.147	-1.39133	0.1685	-3.47963	0.19	-4.17608	0.2115	-9.05615		
0.1475	-1.39133	0.169	-3.47963	0.1905	-4.52437	0.212	-9.40505		
0.148	-1.73927	0.1695	-3.82783	0.191	-4.87271	0.2125	-9.40505		
0.1485	-2.08725	0.17	-4.17608	0.1915	-5.91798	0.213	-9.05615		
0.149	-1.73927	0.1705	-4.52437	0.192	-5.91798	0.2135	-9.40505		
0.1495	-1.73927	0.171	-4.52437	0.1925	-5.91798	0.214	-9.754		
0.15	-1.73927	0.1715	-4.87271	0.193	-5.91798	0.2145	-9.754		
0.1505	-1.73927	0.172	-4.17608	0.1935	-5.91798	0.215	-9.40505		
0.151	-1.73927	0.1725	-4.87271	0.194	-5.91798	0.2155	-9.754		
0.1515	-1.73927	0.173	-5.56951	0.1945	-5.91798	0.216	-9.40505		
0.152	-1.73927	0.1735	-5.91798	0.195	-5.91798	0.2165	-9.40505		
0.1525	-1.04343	0.174	-5.56951	0.1955	-5.91798	0.217	-9.754		
0.153	-0.695576	0.1745	-5.91798	0.196	-5.91798	0.2175	-10.452		
0.1535	-1.04343	0.175	-5.56951	0.1965	-6.26649	0.218	-10.103		
0.154	-1.04343	0.1755	-4.87271	0.197	-6.26649	0.2185	-10.8011		
0.1545	-0.695576	0.176	-5.91798	0.1975	-6.96364	0.219	-10.8011		

Gauge38_6 Time msec	Gauge38_6 Stress MPa	Gauge38_6 Time msec	Gauge38_6 Stress MPa	Gauge38_6 Time msec	Gauge38_6 Stress MPa	Gauge38_6 Time msec	Gauge38_6 Stress MPa	Gauge38_6 Time msec	Gauge38_6 Stress MPa	Gauge38_6 Time msec	Gauge38_6 Stress MPa
0.107	0.176511	0.1285	0	0.15	7.22784	0.1715	2.1174	0.193	6.5235	0.211	0.705977
0.1075	0.176511	0.129	0	0.1505	6.17127	0.172	1.94101	0.193	6.5235	0.2115	0.882444
0.108	0.176511	0.1295	-0.176522	0.151	5.81899	0.1725	1.5882	0.193	4.2332	0.212	1.41178
0.1085	0.176511	0.13	0	0.1515	5.29049	0.173	1.0589	0.1935	2.82284	0.2125	1.5882
0.109	0.353011	0.1305	0	0.152	4.58567	0.1735	2.47014	0.194	2.6465	0.213	1.5882
0.1095	0.176511	0.131	0.176511	0.1525	3.52811	0.174	0.176511	0.1945	2.29378	0.2135	1.5882
0.11	0	0.1315	0	0.153	2.6465	0.1745	-0.176522	0.1945	2.29378	0.214	1.41178
0.1105	0.353011	0.132	0	0.1535	1.41178	0.175	0	0.1945	2.29378	0.2145	1.0589
0.111	0	0.1325	0	0.154	0	0.1755	-0.353055	0.195	1.5882	0.215	1.23534
0.1115	0.176511	0.133	0.176511	0.1545	-2.119	0.176	-1.0593	0.1955	0.176511	0.2155	0.882444
0.112	0.176511	0.1335	0	0.155	-2.649	0.1765	-1.41249	0.196	-2.119	0.216	0.705977
0.1125	0.176511	0.134	-0.176522	0.1555	-3.53255	0.177	-2.119	0.1965	-3.88605	0.2165	0.353011
0.113	0.176511	0.1345	-0.353055	0.156	-4.77	0.1775	-2.47232	0.197	-5.3005	0.217	0
0.1135	0.176511	0.135	-0.706155	0.1565	-5.65422	0.178	-3.1791	0.1975	-6.00798	0.2175	0.176511
0.114	0.176511	0.1355	-0.706155	0.157	-6.18488	0.1785	-3.35582	0.198	-6.71565	0.2175	0.176511
0.1145	0.176511	0.136	-1.23589	0.1575	-6.3618	0.179	-3.88605	0.1985	-7.60048	0.218	0
0.115	0.176511	0.1365	-1.5891	0.158	-6.53872	0.1795	-4.41639	0.199	-8.66265	0.2185	-0.176522
0.1155	0.176511	0.137	-1.94235	0.1585	-6.3618	0.18	-4.77	0.1995	-9.01679	0.2185	-0.176522
0.116	0	0.1375	-2.47232	0.159	-6.3618	0.1805	-4.59319	0.2	-9.90235	0.219	-0.5296
0.1165	0.176511	0.138	-2.82569	0.1595	-6.00798	0.181	-4.59319	0.2005	-9.72522	0.2195	-0.706155
0.117	0.353011	0.1385	-3.1791	0.16	-5.3005	0.1815	-4.41639	0.201	-9.72522	0.22	-0.706155
0.1175	0.353011	0.139	-3.53255	0.1605	-4.77	0.182	-4.2396	0.2015	-9.19388	0.22	-1.23589
0.118	0.353011	0.1395	-3.53255	0.161	-3.53255	0.1825	-3.7093	0.202	-8.66265	0.2205	-1.76572
0.1185	0.176511	0.14	-4.41639	0.1615	-2.82569	0.183	-3.1791	0.2025	-7.06955	0.221	-2.47232
0.119	0.353011	0.1405	-4.06282	0.162	-1.5891	0.1835	-2.82569	0.2025	-7.06955	0.2215	-3.00239
0.1195	0.176511	0.141	-3.88605	0.1625	-0.706155	0.184	-2.29565	0.203	-7.06955	0.222	-3.53255
0.12	0	0.1415	-3.88605	0.163	0.176511	0.1845	-0.706155	0.2035	-6.71565	0.2225	-3.7093
0.1205	0.353011	0.142	-3.7093	0.1635	0.882444	0.185	0.176511	0.204	-6.00798	0.223	-3.88605
0.121	0.176511	0.1425	-3.00239	0.164	1.94101	0.1855	1.41178	0.2045	-5.47735	0.2235	-4.2396
0.1215	0.353011	0.143	-2.649	0.1645	2.47014	0.186	2.47014	0.205	-5.47735	0.224	-4.59319
0.122	0.353011	0.1435	-1.94235	0.165	2.6465	0.1865	3.7044	0.205	-4.94682	0.2245	-5.3005
0.1225	0.353011	0.144	-1.41249	0.1655	2.99917	0.187	5.29049	0.2055	-4.59319	0.2245	-5.3005
0.123	0.176511	0.1445	-0.176522	0.166	2.82284	0.1875	6.34739	0.2055	-4.59319	0.225	-5.3005
0.1235	0.176511	0.145	0.353011	0.1665	2.82284	0.188	8.108	0.206	-4.06282	0.2255	-5.47735
0.124	0.176511	0.1455	1.41178	0.167	2.82284	0.1885	10.3951	0.2065	-3.35582	0.226	-6.3618
0.1245	0.176511	0.146	2.47014	0.1675	2.82284	0.189	12.1532	0.207	-3.1791	0.2265	-6.53872
0.125	0	0.1465	3.35181	0.168	2.82284	0.1895	13.7345	0.2075	-2.47232	0.227	-6.53872
0.1255	0.176511	0.147	4.40944	0.1685	2.82284	0.19	14.0858	0.208	-1.5891	0.2275	-6.53872
0.126	0.176511	0.1475	5.29049	0.169	2.6465	0.1905	14.2614	0.2085	-0.706155	0.2275	-6.53872
0.1265	0	0.148	5.81899	0.1695	2.6465	0.191	14.0858	0.209	-0.5296		
0.127	0.176511	0.1485	6.34739	0.17	2.47014	0.1915	12.3289	0.2095	0		
0.1275	0.176511	0.149	6.6996	0.1705	2.6465	0.192	10.2193	0.21	0.353011		
0.128	0	0.1495	7.05177	0.171	2.47014	0.1925	6.5235	0.2105	0.5295		

Gauge39_1 Time msec	Gauge39_1 Stress MPa	Gauge39_1 Time msec	Gauge39_1 Stress MPa	Gauge39_1 Time msec	Gauge39_1 Stress MPa	Gauge39_1 Time msec	Gauge39_1 Stress MPa	Gauge39_1 Time msec	Gauge39_1 Stress MPa
-0.01125	0	-0.0005	-19.0704	0.01025	0	0.021	-96.5143	0.03175	-38.257
-0.011	0	-0.00025	0	0.0105	0	0.02125	-76.979	0.032	-38.257
-0.01075	0	0	0	0.01075	-19.0704	0.0215	-57.5598	0.03225	-38.257
-0.0105	-19.0704	0.00025	75.119	0.011	-19.0704	0.02175	-57.5598	0.0325	-38.257
-0.01025	0	0.0005	382.845	0.01125	0	0.022	-57.5598	0.03275	0
-0.01	0	0.00075	423.923	0.0115	0	0.02225	-19.0704	0.033	-19.0704
-0.00975	-19.0704	0.001	445.319	0.01175	0	0.0225	-38.257	0.03325	-38.257
-0.0095	0	0.00125	445.319	0.012	0	0.02275	-19.0704	0.0335	-38.257
-0.00925	0	0.0015	445.319	0.01225	-19.0704	0.023	-19.0704	0.03375	-38.257
-0.009	0	0.00175	423.923	0.0125	0	0.02325	0	0.034	-57.5598
-0.00875	-19.0704	0.002	423.923	0.01275	-38.257	0.0235	-19.0704	0.03425	-38.257
-0.0085	0	0.00225	403.093	0.013	-19.0704	0.02375	0	0.0345	-38.257
-0.00825	0	0.0025	382.845	0.01325	-19.0704	0.024	0	0.03475	-38.257
-0.008	0	0.00275	363.193	0.0135	-19.0704	0.02425	0	0.035	-38.257
-0.00775	18.9541	0.003	325.741	0.01375	-19.0704	0.0245	-19.0704	0.03525	-38.257
-0.0075	0	0.00325	290.859	0.014	-19.0704	0.02475	-38.257	0.0355	-38.257
-0.00725	-19.0704	0.0035	290.859	0.01425	-38.257	0.025	0	0.03575	-38.257
-0.007	0	0.00375	237.336	0.0145	-38.257	0.02525	-19.0704		
-0.00675	0	0.004	184.31	0.01475	-57.5598	0.0255	-19.0704		
-0.0065	0	0.00425	166.402	0.015	-57.5598	0.02575	-19.0704		
-0.00625	0	0.0045	93.6081	0.01525	-57.5598	0.026	-38.257		
-0.006	0	0.00475	130.238	0.0155	-76.979	0.02625	-38.257		
-0.00575	0	0.005	111.981	0.01575	-76.979	0.0265	-38.257		
-0.0055	0	0.00525	56.5136	0.016	-57.5598	0.02675	-38.257		
-0.00525	0	0.0055	18.9541	0.01625	-57.5598	0.027	-57.5598		
-0.005	0	0.00575	56.5136	0.0165	-76.979	0.02725	-57.5598		
-0.00475	0	0.006	-57.5598	0.01675	-57.5598	0.0275	-76.979		
-0.0045	0	0.00625	-57.5598	0.017	-57.5598	0.02775	-76.979		
-0.00425	0	0.0065	-38.257	0.01725	-76.979	0.028	-57.5598		
-0.004	-19.0704	0.00675	-76.979	0.0175	-57.5598	0.02825	-57.5598		
-0.00375	0	0.007	-155.818	0.01775	-57.5598	0.0285	-57.5598		
-0.0035	0	0.00725	-76.979	0.018	-76.979	0.02875	-57.5598		
-0.00325	0	0.0075	-19.0704	0.01825	-76.979	0.029	-76.979		
-0.003	0	0.00775	-57.5598	0.0185	-76.979	0.02925	-57.5598		
-0.00275	-19.0704	0.008	-19.0704	0.01875	-76.979	0.0295	-57.5598		
-0.0025	0	0.00825	-57.5598	0.019	-96.5143	0.02975	-57.5598		
-0.00225	0	0.0085	0	0.01925	-76.979	0.03	18.9541		
-0.002	0	0.00875	0	0.0195	-76.979	0.03025	-57.5598		
-0.00175	-19.0704	0.009	18.9541	0.01975	-96.5143	0.0305	-57.5598		
-0.0015	0	0.00925	-19.0704	0.02	-96.5143	0.03075	-57.5598		
-0.00125	18.9541	0.0095	18.9541	0.02025	-96.5143	0.031	-57.5598		
-0.001	0	0.00975	37.792	0.0205	-96.5143	0.03125	-57.5598		
-0.00075	-19.0704	0.01	0	0.02075	-96.5143	0.0315	-76.979		

GaugeJ9_2	GaugeJ9_2	GaugeJ9_2	GaugeJ9_2	GaugeJ9_2	GaugeJ9_2	GaugeJ9_2	GaugeJ9_2	GaugeJ9_2	GaugeJ9_2
Time	Stress	Time	Stress	Time	Stress	Time	Stress	Time	Stress
msec	MPa	msec	MPa	msec	MPa	msec	MPa	msec	MPa
0.0475	0.5295	0.069	0	0.0905	6.5235	0.112	-0.706155	0.1335	-2.649
0.048	0.5295	0.0695	-0.176522	0.091	5.99514	0.1125	-0.706155	0.134	-3.1791
0.0485	0.5295	0.07	0	0.0915	5.46667	0.113	-0.5296	0.1345	-3.1791
0.049	0.882444	0.0705	0	0.092	4.93811	0.1135	-0.176522	0.135	-3.35582
0.0495	1.41178	0.071	0.176511	0.0925	4.2332	0.114	-0.176522	0.1355	-3.53255
0.05	1.0589	0.0715	0	0.093	3.1755	0.1145	0.176511	0.136	-3.88605
0.0505	0.5295	0.072	0.176511	0.0935	2.29378	0.115	-0.176522	0.1365	-4.06282
0.051	0.176511	0.0725	0.176511	0.094	1.5882	0.1155	-0.176522	0.137	-3.7093
0.0515	0.353011	0.073	0.176511	0.0945	1.0589	0.116	-0.353055	0.1375	-3.7093
0.052	0.882444	0.0735	0.176511	0.095	0.705977	0.1165	-0.5296	0.138	-3.53255
0.0525	0.882444	0.074	0.5295	0.0955	0.5295	0.117	-0.5296	0.1385	-3.53255
0.053	0.5295	0.0745	0.176511	0.096	0.176511	0.1175	-0.882721	0.139	-3.35582
0.0535	0.705977	0.075	0.5295	0.0965	-0.353055	0.118	-1.0593	0.1395	-3.1791
0.054	0.882444	0.0755	0.5295	0.097	-0.353055	0.1185	-1.5891	0.14	-3.1791
0.0545	0.882444	0.076	0.353011	0.0975	-0.5296	0.119	-1.94235	0.1405	-2.649
0.055	1.0589	0.0765	0.353011	0.098	-0.5296	0.1195	-1.94235	0.141	-2.47232
0.0555	1.0589	0.077	0.353011	0.0985	-0.5296	0.12	-1.76572	0.1415	-2.29565
0.056	0.705977	0.0775	0.176511	0.099	-0.176522	0.1205	-1.5891	0.142	-2.119
0.0565	0.5295	0.078	0.176511	0.0995	0.176511	0.121	-1.41249	0.1425	-2.119
0.057	0.882444	0.0785	0.353011	0.1	0.5295	0.1215	-2.119	0.143	-1.94235
0.0575	0.882444	0.079	0.5295	0.1005	0.353011	0.122	-2.47232	0.1435	-1.94235
0.058	0.882444	0.0795	0.353011	0.101	0.705977	0.1225	-2.47232	0.144	-1.76572
0.0585	0.882444	0.08	0.5295	0.1015	0.705977	0.123	-2.47232	0.1445	-1.0593
0.059	0.705977	0.0805	0.5295	0.102	0.705977	0.1235	-2.47232	0.145	-0.882721
0.0595	0.5295	0.081	0.5295	0.1025	0.882444	0.124	-2.29565	0.1455	-0.5296
0.06	0.5295	0.0815	0.5295	0.103	1.0589	0.1245	-2.29565	0.146	-0.5296
0.0605	0.705977	0.082	0.705977	0.1035	0.882444	0.125	-2.119	0.1465	-0.5296
0.061	0.5295	0.0825	0.882444	0.104	0.705977	0.1255	-2.82569	0.147	-0.882721
0.0615	0.353011	0.083	1.0589	0.1045	0.353011	0.126	-2.649	0.1475	-0.706155
0.062	0.353011	0.0835	1.23534	0.105	0.353011	0.1265	-2.29565	0.148	-0.882721
0.0625	0.353011	0.084	1.76461	0.1055	0	0.127	-2.119	0.1485	-0.706155
0.063	0.176511	0.0845	2.47014	0.106	-0.176522	0.1275	-2.119	0.149	-0.882721
0.0635	0.176511	0.085	3.35181	0.1065	-0.353055	0.128	-2.119	0.1495	-0.5296
0.064	0	0.0855	4.58567	0.107	-0.706155	0.1285	-2.29565	0.15	-0.882721
0.0645	0	0.086	5.46667	0.1075	-0.882721	0.129	-2.119	0.1505	-0.706155
0.065	0	0.0865	6.5235	0.108	-1.0593	0.1295	-2.29565	0.151	-1.0593
0.0655	0	0.087	7.40389	0.1085	-1.0593	0.13	-2.29565	0.1515	-1.0593
0.066	0	0.0875	8.284	0.109	-1.0593	0.1305	-2.29565	0.152	-1.41249
0.0665	0	0.088	8.45999	0.1095	-1.0593	0.131	-2.47232	0.1525	-1.5891
0.067	-0.176522	0.0885	8.63597	0.11	-1.41249	0.1315	-2.47232	0.153	-1.5891
0.0675	0	0.089	8.284	0.1105	-1.0593	0.132	-2.649	0.1535	-1.94235
0.068	0	0.0895	7.75997	0.111	-1.23589	0.1325	-2.649	0.154	-1.94235
0.0685	0	0.09	7.05177	0.1115	-0.882721	0.133	-3.00239	0.1545	-1.5891

GaugeJ9_2	GaugeJ9_2	GaugeJ9_2	GaugeJ9_2	GaugeJ9_3	GaugeJ9_3	GaugeJ9_3	GaugeJ9_3	GaugeJ9_3	GaugeJ9_3
Time	Stress	Time	Stress	Time	Stress	Time	Stress	Time	Stress
msec	MPa	msec	MPa	msec	MPa	msec	MPa	msec	MPa
0.155	-1.76572	0.1765	-0.882721	0.0625	0.17551	0.084	7.01178	0.1055	-6.85351
0.1555	-1.5891	0.177	-1.23589	0.063	0.17551	0.0845	6.8367	0.106	-7.3814
0.156	-1.76572	0.1775	-1.23589	0.0635	0	0.085	6.13627	0.1065	-7.73338
0.1565	-1.94235	0.178	-1.23589	0.064	0	0.0855	5.43567	0.107	-8.0854
0.157	-1.94235	0.1785	-1.0593	0.0645	0.17551	0.086	4.73489	0.1075	-7.90938
0.1575	-1.76572	0.179	-1.76572	0.065	0	0.0865	4.20919	0.108	-7.73338
0.158	-2.119	0.1795	-1.76572	0.0655	0.17551	0.087	3.5081	0.1085	-7.3814
0.1585	-2.29565	0.18	-2.119	0.066	0	0.0875	2.63149	0.109	-7.02946
0.159	-1.76572	0.1805	-1.41249	0.0665	-0.175521	0.088	1.93	0.1095	-7.20542
0.1595	-1.76572	0.181	-1.76572	0.067	0.17551	0.0885	1.05289	0.11	-6.85351
0.16	-1.94235	0.1815	-1.0593	0.0675	0.17551	0.089	0.17551	0.1105	-6.85351
0.1605	-1.5891	0.182	-1.76572	0.068	0.17551	0.0895	-1.05329	0.111	-6.85351
0.161	-1.5891	0.1825	-1.76572	0.0685	0.17551	0.09	-1.75571	0.1115	-6.50164
0.1615	-1.0593	0.183	-1.76572	0.069	0.17551	0.0905	-2.63398	0.112	-6.85351
0.162	-0.5296	0.1835	-1.76572	0.0695	0.17551	0.091	-3.51252	0.1125	-7.20542
0.1625	-1.23589	0.184	-1.76572	0.07	0	0.0915	-4.21555	0.113	-6.85351
0.163	-1.41249	0.1845	-2.119	0.0705	-0.175521	0.092	-5.0946	0.1135	-6.85351
0.1635	-1.5891	0.185	-2.119	0.071	-0.175521	0.0925	-5.79803	0.114	-6.85351
0.164	-1.23589	0.1855	-2.29565	0.0715	-0.175521	0.093	-6.32572	0.1145	-7.02946
0.1645	-1.0593	0.186	-1.94235	0.072	0	0.0935	-6.67757	0.115	-7.55738
0.165	-1.23589	0.1865	-1.5891	0.0725	0.17551	0.094	-6.85351	0.1155	-7.55738
0.1655	-1.5891	0.187	-1.94235	0.073	0	0.0945	-7.20542	0.116	-7.73338
0.166	-1.94235	0.1875	-1.41249	0.0735	0	0.095	-7.02946	0.1165	-8.0854
0.1665	-1.23589	0.188	-1.5891	0.074	0	0.0955	-7.20542	0.117	-8.61352
0.167	-0.706155	0.1885	-1.5891	0.0745	0	0.096	-7.3814	0.1175	-8.96566
0.1675	-0.5296	0.189	-1.41249	0.075	-0.175521	0.0965	-7.3814	0.118	-8.96566
0.168	-0.882721	0.1895	-1.0593	0.0755	0	0.097	-7.3814	0.1185	-9.14174
0.1685	-1.23589	0.19	-0.882721	0.076	0	0.0975	-7.3814	0.119	-9.14174
0.169	-1.23589	0.1905	-1.0593	0.0765	0	0.098	-7.55738	0.1195	-10.0223
0.1695	-1.76572	0.191	-1.0593	0.077	0.17551	0.0985	-7.20542	0.12	-9.84619
0.17	-1.23589	0.1915	-0.706155	0.0775	0.17551	0.099	-7.02946	0.1205	-10.0223
0.1705	-0.706155	0.192	-0.706155	0.078	0.351009	0.0995	-6.67757	0.121	-10.0223
0.171	-1.0593	0.1925	-0.5296	0.0785	1.05289	0.1	-6.14981	0.1215	-9.84619
0.1715	-1.76572	0.193	-0.5296	0.079	1.93	0.1005	-6.14981	0.122	-9.49395
0.172	-0.882721	0.1935	-0.176522	0.0795	3.15749	0.101	-6.14981	0.1225	-9.49395
0.1725	-1.23589	0.194	0	0.08	5.26049	0.1015	-6.14981	0.123	-9.31784
0.173	-1.23589	0.1945	0	0.0805	7.01178	0.102	-6.32572	0.1235	-8.78959
0.1735	-0.706155	0.195	0	0.081	8.58699	0.1025	-6.50164	0.124	-8.96566
0.174	-1.23589	0.1955	0	0.0815	8.58699	0.103	-6.85351	0.1245	-8.96566
0.1745	-1.0593	0.196	0.176511	0.082	8.06202	0.1035	-6.85351	0.125	-10.727
0.175	-1.0593	0.1965	0	0.0825	7.53695	0.104	-6.50164	0.1255	-9.31784
0.1755	-1.0593			0.083	7.18685	0.1045	-6.50164	0.126	-9.14174
0.176	-0.882721			0.0835	7.18685	0.105	-6.85351	0.1265	-8.61352

Gauge39_3 Time msec	Gauge39_3 Stress MPa	Gauge39_3 Time msec	Gauge39_3 Stress MPa	Gauge39_3 Time msec	Gauge39_3 Stress MPa	Gauge39_3 Time msec	Gauge39_3 Stress MPa	Gauge39_3 Time msec	Gauge39_3 Stress MPa
0.127	-8.26143	0.1485	-4.56714	0.17	-4.91876	0.1915	-3.51252	0.213	-0.175521
0.1275	-7.3814	0.149	-4.56714	0.1705	-4.91876	0.192	-3.33679	0.2135	0
0.128	-7.20542	0.1495	-4.56714	0.171	-5.44629	0.1925	-3.16107	0.214	0
0.1285	-6.67757	0.15	-4.56714	0.1715	-5.0946	0.193	-2.98536	0.2145	0.17551
0.129	-6.32572	0.1505	-4.74295	0.172	-4.91876	0.1935	-2.80966	0.215	0.351009
0.1295	-5.97391	0.151	-4.74295	0.1725	-5.62215	0.194	-2.80966	0.2155	0.526497
0.13	-5.62215	0.1515	-4.74295	0.173	-5.44629	0.1945	-2.80966	0.216	1.05289
0.1305	-5.44629	0.152	-4.74295	0.1735	-5.0946	0.195	-2.98536	0.2165	1.05289
0.131	-5.0946	0.1525	-5.0946	0.174	-5.62215	0.1955	-2.63398	0.217	1.05289
0.1315	-5.44629	0.153	-5.0946	0.1745	-5.27044	0.196	-2.4583	0.2175	1.05289
0.132	-5.62215	0.1535	-5.0946	0.175	-5.44629	0.1965	-2.80966	0.218	1.05289
0.1325	-6.32572	0.154	-4.91876	0.1755	-5.79803	0.197	-2.80966	0.2185	1.05289
0.133	-5.62215	0.1545	-5.0946	0.176	-5.62215	0.1975	-2.80966	0.219	1.22834
0.1335	-6.50164	0.155	-5.27044	0.1765	-5.79803	0.198	-2.80966	0.2195	1.22834
0.134	-7.20542	0.1555	-5.44629	0.177	-5.44629	0.1985	-2.80966	0.22	1.22834
0.1345	-7.55738	0.156	-5.44629	0.1775	-5.97391	0.199	-2.98536	0.2205	1.22834
0.135	-7.90938	0.1565	-5.44629	0.178	-6.14981	0.1995	-2.80966	0.221	1.57919
0.1355	-8.26143	0.157	-5.44629	0.1785	-6.50164	0.2	-2.98536	0.2215	1.40377
0.136	-8.61352	0.1575	-5.27044	0.179	-6.67757	0.2005	-2.98536	0.222	1.40377
0.1365	-8.78959	0.158	-5.62215	0.1795	-7.20542	0.201	-2.98536	0.2225	1.57919
0.137	-9.14174	0.1585	-5.62215	0.18	-7.20542	0.2015	-2.80966	0.223	1.57919
0.1375	-8.96566	0.159	-5.44629	0.1805	-7.02946	0.202	-3.16107	0.2235	1.57919
0.138	-8.96566	0.1595	-5.27044	0.181	-6.85351	0.2025	-3.16107	0.224	1.57919
0.1385	-8.96566	0.16	-5.44629	0.1815	-7.02946	0.203	-3.33679	0.2245	1.7546
0.139	-9.14174	0.1605	-5.44629	0.182	-7.02946	0.2035	-3.33679	0.225	1.7546
0.1395	-8.96566	0.161	-5.0946	0.1825	-7.20542	0.204	-3.68826	0.2255	1.7546
0.14	-8.78959	0.1615	-5.27044	0.183	-7.20542	0.2045	2.10539	0.226	1.40377
0.1405	-8.26143	0.162	-5.0946	0.1835	-7.55738	0.205	-0.877715	0.2265	1.57919
0.141	-7.73338	0.1625	-5.0946	0.184	-7.3814	0.2055	-1.40448	0.227	1.40377
0.1415	-7.3814	0.163	-5.0946	0.1845	-7.20542	0.206	-0.877715	0.2275	1.57919
0.142	-6.85351	0.1635	-4.91876	0.185	-7.02946	0.2065	-1.22888	0.228	1.40377
0.1425	-6.32572	0.164	-4.74295	0.1855	-6.67757	0.207	-1.58009	0.2285	1.40377
0.143	-5.97803	0.1645	-4.74295	0.186	-6.50164	0.2075	-1.22888	0.229	1.22834
0.1435	-5.44629	0.165	-4.39134	0.1865	-6.14981	0.208	-1.40448	0.2295	1.22834
0.144	-5.27044	0.1655	-4.21555	0.187	-6.14981	0.2085	-1.40448	0.23	1.05289
0.1445	-5.27044	0.166	-4.03978	0.1875	-5.79803	0.209	-0.877715	0.2305	1.22834
0.145	-5.0946	0.1665	-4.39134	0.188	-5.79803	0.2095	-1.05329	0.231	0.877439
0.1455	-4.91876	0.167	-4.39134	0.1885	-5.44629	0.21	-1.05329	0.2315	0.877439
0.146	-4.91876	0.1675	-4.39134	0.189	-5.0946	0.2105	-0.877715	0.232	1.22834
0.1465	-4.74295	0.168	-4.39134	0.1895	-4.39134	0.211	-0.70215	0.2325	1.05289
0.147	-4.56714	0.1685	-4.56714	0.19	-4.21555	0.2115	-0.70215	0.233	0.877439
0.1475	-4.56714	0.169	-4.56714	0.1905	-4.03978	0.212	-0.877715	0.2335	0.877439
0.148	-4.56714	0.1695	-4.91876	0.191	-3.86401	0.2125	-0.351053	0.234	0.877439

Gauge39_3 Time msec	Gauge39_3 Stress MPa	Gauge39_4 Time msec	Gauge39_4 Stress MPa	Gauge39_4 Time msec	Gauge39_4 Stress MPa	Gauge39_4 Time msec	Gauge39_4 Stress MPa	Gauge39_4 Time msec	Gauge39_4 Stress MPa
0.2345	0.877439	0.1115	0	0.133	-0.17519	0.1545	6.8238	0.176	-6.13821
0.235	0.877439	0.112	0	0.1335	0	0.155	5.60025	0.1765	-5.96264
0.2355	1.05289	0.1125	0	0.134	0	0.1555	4.55106	0.177	-5.78709
0.236	1.22834	0.113	0	0.1345	-0.17519	0.156	3.67644	0.1775	-5.43601
0.2365	1.22834	0.1135	0	0.135	-0.17519	0.1565	2.62652	0.178	-5.61154
0.237	1.22834	0.114	0	0.1355	0	0.157	1.57621	0.1785	-5.61154
0.2375	1.22834	0.1145	0	0.136	0	0.1575	1.05091	0.179	-5.43601
0.238	1.40377	0.115	0.175179	0.1365	0	0.158	0.175179	0.1795	-5.43601
0.2385	1.40377	0.1155	0.175179	0.137	-0.17519	0.1585	-1.0513	0.18	-5.61154
0.239	1.57919	0.116	0.175179	0.1375	0	0.159	-1.75239	0.1805	-5.26049
0.2395	1.57919	0.1165	0	0.138	0	0.1595	-1.57711	0.181	-4.734
0.24	1.93	0.117	0.175179	0.1385	0	0.16	-1.92769	0.1815	-4.55852
0.2405	1.7546	0.1175	0.175179	0.139	0	0.1605	-2.45366	0.182	-4.38305
0.241	1.7546	0.118	0.175179	0.1395	-0.17519	0.161	-2.62901	0.1825	-4.03216
0.2415	2.10539	0.1185	0.175179	0.14	0	0.1615	-3.1551	0.183	-4.03216
0.242	2.10539	0.119	0.175179	0.1405	0.525503	0.162	-3.33049	0.1835	-3.85672
0.2425	2.28077	0.1195	0.175179	0.141	0	0.1625	-3.33049	0.184	-3.85672
0.243	2.28077	0.12	0.175179	0.1415	-0.17519	0.163	-3.50589	0.1845	-3.6813
0.2435	2.28077	0.1205	0.175179	0.142	-0.17519	0.1635	-3.6813	0.185	-3.6813
0.244	2.28077	0.121	0	0.1425	0.350347	0.164	-3.6813	0.1855	-3.85672
0.2445	2.10539	0.1215	0.175179	0.143	0.175179	0.1645	-3.85672	0.186	-3.6813
0.245	1.93	0.122	0.175179	0.1435	0.175179	0.165	-4.03216	0.1865	-3.6813
0.2455	2.28077	0.1225	0.175179	0.144	0.175179	0.1655	-4.03216	0.187	-3.85672
		0.123	0.350347	0.1445	0.350347	0.166	-4.03216	0.1875	-3.85672
		0.1235	0.175179	0.145	0.175179	0.1665	-4.38305	0.188	-3.85672
		0.124	0.175179	0.1455	0.175179	0.167	-4.03216	0.1885	-3.85672
		0.1245	0	0.146	0.175179	0.1675	-4.38305	0.189	-3.6813
		0.125	0.175179	0.1465	0.175179	0.168	-4.55852	0.1895	-3.85672
		0.1255	0	0.147	0.350347	0.1685	-4.734	0.19	-4.2076
		0.126	0.175179	0.1475	0.700649	0.169	-4.55852	0.1905	-4.2076
		0.1265	0.175179	0.148	0.525503	0.1695	-4.734	0.191	-4.2076
		0.127	0.175179	0.1485	0.875784	0.17	-5.08498	0.1915	-4.38305
		0.1275	0.175179	0.149	1.05091	0.1705	-5.08498	0.192	-4.38305
		0.128	0	0.1495	1.22602	0.171	-5.61154	0.1925	-4.38305
		0.1285	0	0.15	1.75129	0.1715	-5.78709	0.193	-4.55852
		0.129	0	0.1505	2.10142	0.172	-5.61154	0.1935	-4.734
		0.1295	0.175179	0.151	2.97654	0.1725	-5.61154	0.194	-4.55852
		0.13	0	0.1515	4.02632	0.173	-6.13821	0.1945	-4.734
		0.1305	0.175179	0.152	5.07571	0.1735	-6.13821	0.195	-4.55852
		0.131	0.175179	0.1525	6.29949	0.174	-6.31378	0.1955	-4.734
		0.1315	0.175179	0.153	6.99855	0.1745	-6.31378	0.196	-4.734
		0.132	0	0.1535	7.34801	0.175	-6.31378	0.1965	-4.55852
		0.1325	0	0.154	7.34801	0.1755	-6.13821	0.197	-4.734

Gauge39_4 Time msec	Gauge39_4 Stress MPa	Gauge39_4 Time msec	Gauge39_4 Stress MPa	Gauge39_4 Time msec	Gauge39_4 Stress MPa	Gauge39_5 Time msec	Gauge39_5 Stress MPa	Gauge39_5 Time msec	Gauge39_5 Stress MPa
0.1975	-4.734	0.219	-4.03216	0.2405	-0.525603	0.0985	0.175842	0.12	0.175842
0.198	-4.734	0.2195	-3.6813	0.241	-0.525603	0.099	0.175842	0.1205	0
0.1985	-4.55852	0.22	-3.85672	0.2415	-0.350391	0.0995	0.175842	0.121	0.351674
0.199	-4.55852	0.2205	-3.50589	0.242	-0.525603	0.1	0	0.1215	0.175842
0.1995	-4.734	0.221	-3.50589	0.2425	-0.525603	0.1005	0.175842	0.122	0.351674
0.2	-4.55852	0.2215	-3.1551	0.243	-0.350391	0.101	0	0.1225	0.351674
0.2005	-4.734	0.222	-3.1551	0.2435	-0.17519	0.1015	0.175842	0.123	0.175842
0.201	-4.55852	0.2225	-3.33049	0.244	-0.17519	0.102	0.175842	0.1235	0.351674
0.2015	-4.55852	0.223	-3.33049	0.2445	0	0.1025	0.175842	0.124	0.351674
0.202	-4.734	0.2235	-3.33049	0.245	0	0.103	0	0.1245	0.351674
0.2025	-4.734	0.224	-3.33049	0.2455	0.175179	0.1035	0	0.125	0.351674
0.203	-4.90948	0.2245	-3.33049	0.246	0.175179	0.104	0.175842	0.1255	0.351674
0.2035	-4.90948	0.225	-3.1551			0.1045	-0.175853	0.126	0.175842
0.204	-4.90948	0.2255	-3.1551			0.105	0	0.1265	0.175842
0.2045	-5.08498	0.226	-2.97973			0.1055	0	0.127	0.351674
0.205	-2.80436	0.2265	-2.97973			0.106	0	0.1275	0.351674
0.2055	-3.1551	0.227	-3.1551			0.1065	0.175842	0.128	0.175842
0.206	-3.85672	0.2275	-2.97973			0.107	0.175842	0.1285	0.175842
0.2065	-3.6813	0.228	-2.97973			0.1075	0	0.129	0.351674
0.207	-3.33049	0.2285	-3.1551			0.108	0	0.1295	0
0.2075	-3.85672	0.229	-2.80436			0.1085	0	0.13	0.351674
0.208	-3.6813	0.2295	-2.62901			0.109	-0.175853	0.1305	0.175842
0.2085	-3.6813	0.23	-2.62901			0.1095	0	0.131	0
0.209	-3.85672	0.2305	-2.45366			0.11	0	0.1315	0.175842
0.2095	-4.03216	0.231	-2.10301			0.1105	-0.175853	0.132	0.175842
0.21	-4.03216	0.2315	-1.92769			0.111	0	0.1325	0
0.2105	-4.2076	0.232	-2.10301			0.1115	-0.351718	0.133	-0.175853
0.211	-3.85672	0.2325	-2.10301			0.112	-0.175853	0.1335	0.175842
0.2115	-4.03216	0.233	-1.92769			0.1125	-0.175853	0.134	0.175842
0.212	-3.85672	0.2335	-1.75239			0.113	-0.175853	0.1345	0.175842
0.2125	-3.85672	0.234	-2.10301			0.1135	-0.175853	0.135	0.175842
0.213	-3.85672	0.2345	-1.92769			0.114	0.175842	0.1355	0.351674
0.2135	-3.85672	0.235	-2.10301			0.1145	0	0.136	0.527494
0.214	-4.2076	0.2355	-1.75239			0.115	-0.175853	0.1365	0.527494
0.2145	-4.03216	0.236	-1.57711			0.1155	-0.351718	0.137	0.703303
0.215	-4.03216	0.2365	-1.40183			0.116	-0.175853	0.1375	1.23066
0.2155	-4.03216	0.237	-1.22656			0.1165	-0.175853	0.138	2.10938
0.216	-4.03216	0.2375	-1.40183			0.117	0	0.1385	2.63647
0.2165	-4.2076	0.238	-1.0513			0.1175	-0.175853	0.139	3.33911
0.217	-3.85672	0.2385	-1.22656			0.118	-0.175853	0.1395	4.21716
0.2175	-4.03216	0.239	-1.0513			0.1185	0	0.14	4.74386
0.218	-4.03216	0.2395	-0.876059			0.119	0	0.1405	4.9194
0.2185	-3.85672	0.24	-0.700825			0.1195	0.175842	0.141	4.5683

Gauge39_5 Time msec	Gauge39_5 Stress MPa	Gauge39_5 Time msec	Gauge39_5 Stress MPa	Gauge39_5 Time msec	Gauge39_5 Stress MPa	Gauge39_5 Time msec	Gauge39_5 Stress MPa	Gauge39_5 Time msec	Gauge39_5 Stress MPa
0.1415	4.21716	0.163	-8.98264	0.1845	-13.5731	0.206	-11.9833	0.2275	-10.5708
0.142	3.33911	0.1635	-9.15906	0.185	-13.5731	0.2065	-11.8067	0.228	-10.5708
0.1425	2.98781	0.164	-9.33549	0.1855	-13.5731	0.207	-11.8067	0.2285	-10.5708
0.143	2.46079	0.1645	-9.51193	0.186	-13.7498	0.2075	-12.1599	0.229	-10.5708
0.1435	2.10938	0.165	-10.0413	0.1865	-13.9265	0.208	-11.8067	0.2295	-10.7473
0.144	2.10938	0.1655	-10.0413	0.187	-13.9265	0.2085	-11.6301	0.23	-10.5708
0.1445	1.75793	0.166	-10.7473	0.1875	-13.9265	0.209	-11.6301	0.2305	-10.5708
0.145	1.23066	0.1665	-10.7473	0.188	-14.1033	0.2095	-11.6301	0.231	-10.3943
0.1455	1.40643	0.167	-11.1004	0.1885	-14.1033	0.21	-11.6301	0.2315	-10.5708
0.146	1.23066	0.1675	-11.2769	0.189	-13.9265	0.2105	-11.6301	0.232	-10.3943
0.1465	0.703303	0.168	-11.4535	0.1895	-13.9265	0.211	-11.6301	0.2325	-10.0413
0.147	0.351674	0.1685	-11.8067	0.19	-13.9265	0.2115	-11.6301	0.233	-10.2178
0.1475	-0.175853	0.169	-12.1599	0.1905	-13.9265	0.212	-11.6301	0.2335	-10.0413
0.148	-0.527593	0.1695	-12.5131	0.191	-13.9265	0.2125	-11.6301	0.234	-9.68838
0.1485	-1.23121	0.17	-12.6897	0.1915	-13.7498	0.213	-11.6301	0.2345	-9.68838
0.149	-1.75903	0.1705	-13.2197	0.192	-13.9265	0.2135	-11.6301	0.235	-9.51193
0.1495	-1.935	0.171	-13.0431	0.1925	-13.7498	0.214	-11.6301	0.2355	-9.33549
0.15	-2.81498	0.1715	-13.5731	0.193	-13.7498	0.2145	-11.6301	0.236	-9.33549
0.1505	-3.16706	0.172	-13.0431	0.1935	-13.3964	0.215	-11.4535	0.2365	-9.15906
0.151	-3.51917	0.1725	-13.5731	0.194	-13.2197	0.2155	-11.6301	0.237	-9.15906
0.1515	-4.04743	0.173	-13.5731	0.1945	-12.8664	0.216	-11.6301	0.2375	-8.98264
0.152	-4.57579	0.1735	-13.3964	0.195	-12.8664	0.2165	-11.4535	0.238	-8.98264
0.1525	-4.92808	0.174	-13.5731	0.1955	-12.8664	0.217	-11.4535	0.2385	-8.80623
0.153	-5.28042	0.1745	-14.1033	0.196	-12.6897	0.2175	-11.1004	0.239	-8.80623
0.1535	-5.6328	0.175	-13.7498	0.1965	-12.8664	0.218	-11.1004	0.2395	-8.62984
0.154	-5.80901	0.1755	-13.5731	0.197	-13.0431	0.2185	-11.1004	0.24	-8.45345
0.1545	-6.3377	0.176	-13.9265	0.1975	-13.3964	0.219	-11.1004	0.2405	-8.45345
0.155	-6.69021	0.1765	-13.3964	0.198	-13.2197	0.2195	-11.1004		
0.1555	-6.86649	0.177	-13.5731	0.1985	-13.3964	0.22	-11.1004		
0.156	-7.04277	0.1775	-13.3964	0.199	-13.3964	0.2205	-11.1004		
0.1565	-7.04277	0.178	-13.0431	0.1995	-13.3964	0.221	-11.1004		
0.157	-7.21907	0.1785	-13.0431	0.2	-13.3964	0.2215	-11.1004		
0.1575	-7.74802	0.179	-13.0431	0.2005	-13.7498	0.222	-11.1004		
0.158	-7.74802	0.1795	-13.0431	0.201	-13.3964	0.2225	-11.1004		
0.1585	-8.62984	0.18	-12.8664	0.2015	-13.2197	0.223	-11.1004		
0.159	-8.27708	0.1805	-12.8664	0.202	-13.2197	0.2235	-11.1004		
0.1595	-7.92436	0.181	-12.8664	0.2025	-13.3964	0.224	-10.7473		
0.16	-8.10072	0.1815	-12.5131	0.203	-13.0431	0.2245	-10.7473		
0.1605	-8.62984	0.182	-12.8664	0.2035	-13.0431	0.225	-10.5708		
0.161	-8.45345	0.1825	-13.2197	0.204	-13.0431	0.2255	-10.5708		
0.1615	-8.80623	0.183	-13.5731	0.2045	-12.5131	0.226	-10.5708		
0.162	-8.80623	0.1835	-13.5731	0.205	-11.1004	0.2265	-10.5708		
0.1625	-9.15906	0.184	-13.0431	0.2055	-11.8067	0.227	-10.5708		

Gauge40_1 Time msec	Gauge40_1 Stress MPa	Gauge40_1 Time msec	Gauge40_1 Stress MPa	Gauge40_2 Time msec	Gauge40_2 Stress MPa	Gauge40_2 Time msec	Gauge40_2 Stress MPa	Gauge40_2 Time msec	Gauge40_2 Stress MPa
-0.00375	0	0.0075	18.6712	0.061	0.357772	0.0825	0	0.104	1.78841
-0.0035	0	0.00775	37.2279	0.0615	0.715499	0.083	0.715499	0.1045	2.50346
-0.00325	0	0.008	37.2279	0.062	0.715499	0.0835	0.357772	0.105	2.68219
-0.003	0	0.00825	-18.7857	0.0625	0.894346	0.084	0.536641	0.1055	3.21833
-0.0025	0	0.0085	-37.686	0.063	0.715499	0.0845	0.536641	0.106	3.39702
-0.00225	37.2279	0.00875	-133.905	0.0635	0.715499	0.085	0.536641	0.1065	2.50346
-0.002	37.2279	0.009	-56.7007	0.064	0.715499	0.0855	0.894346	0.107	3.39702
-0.00175	-18.7857	0.00925	-56.7007	0.0645	0.536641	0.086	0.715499	0.1075	3.39702
-0.0015	-18.7857	0.0095	-95.0738	0.065	0.715499	0.0865	1.07318	0.108	3.39702
-0.00125	37.2279	0.00975	-37.686	0.0655	0.715499	0.087	1.252	0.1085	3.39702
-0.001	18.6712	0.01	-37.686	0.066	0.715499	0.0875	2.32471	0.109	3.21833
-0.00075	18.6712			0.0665	0.894346	0.088	3.57569	0.1095	3.03963
-0.00025	18.6712			0.067	0.715499	0.0885	4.64752	0.11	2.50346
0	18.6712			0.0675	0.536641	0.089	6.25451	0.1105	2.50346
0.00025	37.2279			0.068	0.536641	0.0895	7.68217	0.111	2.14596
0.0005	55.6701			0.0685	0.715499	0.09	8.21736	0.1115	1.96719
0.00075	55.6701			0.069	0.536641	0.0905	8.39573	0.112	1.43082
0.001	73.9978			0.0695	0.536641	0.091	6.78996	0.1125	1.252
0.00125	110.31			0.07	0.536641	0.0915	5.89748	0.113	0.894346
0.0015	146.163			0.0705	0.715499	0.092	5.00471	0.1135	0.715499
0.00175	233.794			0.071	0.536641	0.0925	4.46891	0.114	0.536641
0.002	233.794			0.0715	0.894346	0.093	4.11166	0.1145	0.357772
0.00225	110.31			0.072	0.715499	0.0935	3.21833	0.115	0.357772
0.0025	181.559			0.0725	0.357772	0.094	2.32471	0.1155	0.178892
0.00275	128.294			0.073	0.536641	0.0945	1.96719	0.116	-0.178903
0.003	146.163			0.0735	0.536641	0.095	1.252	0.1165	-0.357817
0.00325	146.163			0.074	0.715499	0.0955	0	0.117	-0.357817
0.0035	199.085			0.0745	-0.715679	0.096	-0.894627	0.1175	-0.894627
0.00375	287.208			0.075	0.536641	0.0965	-1.43154	0.118	-0.894627
0.004	199.085			0.0755	0.357772	0.097	-2.32662	0.1185	-0.894627
0.00425	110.31			0.076	0.536641	0.0975	-2.68473	0.119	-0.894627
0.0045	92.211			0.0765	0.178892	0.098	-2.8638	0.1195	-1.43154
0.00475	55.6701			0.077	0.536641	0.0985	-2.8638	0.12	-1.61053
0.005	55.6701			0.0775	0.357772	0.099	-2.8638	0.1205	-1.43154
0.00525	73.9978			0.078	0	0.0995	-2.50567	0.121	-1.43154
0.0055	73.9978			0.0785	0	0.1	-2.32662	0.1215	-1.43154
0.00575	73.9978			0.079	-0.178903	0.1005	-2.14758	0.122	-1.07359
0.006	37.2279			0.0795	0.178892	0.101	-1.78954	0.1225	-3.22198
0.00625	55.6701			0.08	0.178892	0.1015	-1.61053	0.123	-1.78954
0.0065	37.2279			0.0805	0.178892	0.102	-1.25256	0.1235	-2.32662
0.00675	37.2279			0.081	0.178892	0.1025	-0.536742	0.124	-2.14758
0.007	37.2279			0.0815	0	0.103	0.357772	0.1245	-2.14758
0.00725	18.6712			0.082	0	0.1035	1.07318	0.125	-1.96855

Gauge40_2 Time msec	Gauge40_2 Stress MPa	Gauge40_2 Time msec	Gauge40_2 Stress MPa	Gauge40_2 Time msec	Gauge40_2 Stress MPa	Gauge40_2 Time msec	Gauge40_2 Stress MPa	Gauge40_2 Time msec	Gauge40_2 Stress MPa
0.1255	-1.78954	0.1475	-2.8638	0.1695	-2.32662	0.1915	-2.50567	0.2135	-2.14758
0.126	-1.43154	0.148	-3.04288	0.17	-2.50567	0.192	-2.68473	0.214	-2.14758
0.1265	-1.43154	0.1485	-3.40108	0.1705	-2.68473	0.1925	-2.8638	0.2145	-1.96855
0.127	-0.357817	0.149	-1.78954	0.171	-2.68473	0.193	-3.04288	0.215	-1.96855
0.1275	-0.536742	0.1495	-2.68473	0.1715	-2.8638	0.1935	-3.22198	0.2155	-1.78954
0.128	-0.715679	0.15	-2.8638	0.172	-2.8638	0.194	-3.40108	0.216	-1.96855
0.1285	-0.357817	0.1505	-3.04288	0.1725	-2.8638	0.1945	-3.93847	0.2165	-1.78954
0.129	-0.357817	0.151	-3.04288	0.173	-2.68473	0.195	-4.29678	0.217	-1.96855
0.1295	0.178892	0.1515	-3.04288	0.1735	-2.8638	0.1955	-4.47595	0.2175	-1.78954
0.13	0.178892	0.152	-2.8638	0.174	-2.8638	0.196	-4.65514	0.218	-1.78954
0.1305	0.178892	0.1525	-3.04288	0.1745	-3.04288	0.1965	-5.01354	0.2185	-1.78954
0.131	0	0.153	-3.04288	0.175	-2.8638	0.197	-5.19276	0.219	-1.96855
0.1315	0.357772	0.1535	-2.8638	0.1755	-3.04288	0.1975	-5.55123	0.2195	-1.96855
0.132	-0.178903	0.154	-3.04288	0.176	-3.22198	0.198	-5.55123	0.22	-1.96855
0.1325	-0.178903	0.1545	-2.8638	0.1765	-2.8638	0.1985	-5.73048	0.2205	-1.78954
0.133	0	0.155	-2.8638	0.177	-2.68473	0.199	-5.73048	0.221	-1.78954
0.1335	-0.357817	0.1555	-2.8638	0.1775	-3.04288	0.1995	-5.90974	0.2215	-1.78954
0.134	-0.178903	0.156	-3.04288	0.178	-2.8638	0.2	-5.90974	0.222	-1.78954
0.1345	-0.536742	0.1565	-3.04288	0.1785	-2.8638	0.2005	-5.73048	0.2225	-1.78954
0.135	-0.536742	0.157	-3.04288	0.179	-3.04288	0.201	-5.55123	0.223	-1.61053
0.1355	-0.357817	0.1575	-3.04288	0.1795	-2.68473	0.2015	-5.19276	0.2235	-1.78954
0.136	-0.715679	0.158	-3.04288	0.18	-2.68473	0.202	-5.19276	0.224	-1.61053
0.1365	-0.715679	0.1585	-3.04288	0.1805	-2.68473	0.2025	-4.83433	0.2245	-1.78954
0.137	-1.07359	0.159	-3.04288	0.181	-2.8638	0.203	-4.47595	0.225	-1.61053
0.1375	-1.07359	0.1595	-2.8638	0.1815	-2.8638	0.2035	-4.29678	0.2255	-1.25256
0.138	-0.894627	0.16	-2.8638	0.182	-2.68473	0.204	-4.29678	0.226	-1.43154
0.1385	-0.894627	0.1605	-2.68473	0.1825	-3.04288	0.2045	-3.93847	0.2265	-1.43154
0.139	-1.07359	0.161	-2.68473	0.183	-2.8638	0.205	-3.5802	0.227	-1.07359
0.1395	-1.25256	0.1615	-2.32662	0.1835	-2.32662	0.2055	-3.5802	0.2275	-1.43154
0.14	-1.25256	0.162	-2.50567	0.184	-2.50567	0.206	-3.22198	0.228	-1.25256
0.1405	-1.07359	0.1625	-2.32662	0.1845	-2.32662	0.2065	-3.22198	0.2285	-1.61053
0.141	-1.07359	0.163	-2.14758	0.185	-2.14758	0.207	-3.04288	0.229	-1.78954
0.1415	-1.43154	0.1635	-2.14758	0.1855	-1.96855	0.2075	-2.8638	0.2295	-1.96855
0.142	-1.07359	0.164	-1.96855	0.186	-1.61053	0.208	-2.8638	0.23	-1.96855
0.1425	-1.25256	0.1645	-1.78954	0.1865	-1.78954	0.2085	-2.50567	0.2305	-2.32662
0.143	-1.25256	0.165	-1.78954	0.187	-1.61053	0.209	-2.32662	0.231	-2.32662
0.1435	-1.25256	0.1655	-1.78954	0.1875	-1.43154	0.2095	-2.14758	0.2315	-2.50567
0.144	-2.32662	0.166	-1.61053	0.188	-1.43154	0.21	-2.14758	0.232	-2.68473
0.1445	-1.96855	0.1665	-1.96855	0.1885	-1.43154	0.2105	-2.14758	0.2325	-2.8638
0.145	-1.96855	0.167	-1.96855	0.189	-1.43154	0.211	-1.96855	0.233	-3.04288
0.1455	-1.96855	0.1675	-2.14758	0.1895	-1.43154	0.2115	-1.96855	0.2335	-3.22198
0.146	-2.32662	0.168	-2.14758	0.19	-2.14758	0.212	-1.96855	0.234	-3.22198
0.1465	-1.78954	0.1685	-2.14758	0.1905	-2.14758	0.2125	-1.78954	0.2345	-3.40108
0.147	-2.50567	0.169	-2.68473	0.191	-2.32662	0.213	-1.96855	0.235	-3.5802



Gauge40_2 Time msec	Gauge40_2 Stress MPa	Gauge40_3 Time msec	Gauge40_3 Stress MPa	Gauge40_3 Time msec	Gauge40_3 Stress MPa	Gauge40_3 Time msec	Gauge40_3 Stress MPa	Gauge40_3 Time msec	Gauge40_3 Stress MPa
0.2355	-3.93647	0.0675	0.178892	0.089	6.61149	0.1105	0.715499	0.132	-2.14758
0.236	-4.11762	0.068	0	0.0895	5.89748	0.111	0.894346	0.1325	-2.68473
0.2365	-4.29678	0.0685	0	0.09	4.11166	0.1115	0.536641	0.133	-2.8638
0.237	-4.47595	0.069	0.357772	0.0905	2.68219	0.112	0.715499	0.1335	-3.40108
		0.0695	0.178892	0.091	0.894346	0.1125	0.894346	0.134	-4.11762
		0.07	0.178892	0.0915	-0.178903	0.113	0.894346	0.1345	-4.47595
		0.0705	0.178892	0.092	-0.178903	0.1135	1.07318	0.135	-4.65514
		0.071	0.357772	0.0925	0.536641	0.114	1.07318	0.1355	-5.01354
		0.0715	0.178892	0.093	0.357772	0.1145	1.07318	0.136	-5.37199
		0.072	0.357772	0.0935	0.178892	0.115	1.07318	0.1365	-5.55123
		0.0725	0.178892	0.094	-0.178903	0.1155	1.07318	0.137	-6.08902
		0.073	0.178892	0.0945	-0.178903	0.116	0.715499	0.1375	-6.08902
		0.0735	0.178892	0.095	-0.715679	0.1165	0.894346	0.138	-6.4476
		0.074	0.357772	0.0955	-1.43154	0.117	0.715499	0.1385	-6.4476
		0.0745	0.357772	0.096	-1.61053	0.1175	0.357772	0.139	-6.4476
		0.075	0	0.0965	-1.96855	0.118	0.178892	0.1395	-6.62691
		0.0755	0.357772	0.097	-2.68473	0.1185	0	0.14	-6.62691
		0.076	0.357772	0.0975	-2.68473	0.119	-0.357817	0.1405	-6.4476
		0.0765	0.178892	0.098	-3.04288	0.1195	-0.536742	0.141	-6.4476
		0.077	0.178892	0.0985	-3.04288	0.12	-0.536742	0.1415	-6.62691
		0.0775	0.178892	0.099	-3.22198	0.1205	-0.894627	0.142	-6.4476
		0.078	0.178892	0.0995	-3.22198	0.121	-1.25256		
		0.0785	0.178892	0.1	-3.22198	0.1215	-1.61053		
		0.079	0.178892	0.1005	-3.22198	0.122	-3.22198		
		0.0795	0.357772	0.101	-2.68473	0.1225	-3.04288		
		0.08	0	0.1015	-2.50567	0.123	-2.68473		
		0.0805	0.178892	0.102	-2.14758	0.1235	-2.68473		
		0.081	0	0.1025	-1.78954	0.124	-2.68473		
		0.0815	0.178892	0.103	-1.43154	0.1245	-2.8638		
		0.082	0.178892	0.1035	-1.25256	0.125	-2.68473		
		0.0825	0.178892	0.104	-0.894627	0.1255	-2.68473		
		0.083	1.60962	0.1045	-0.715679	0.126	-2.50567		
		0.0835	0.536641	0.105	-0.894627	0.1265	-2.32662		
		0.084	0.536641	0.1055	-0.715679	0.127	-1.78954		
		0.0845	0.715499	0.106	-0.536742	0.1275	-1.96855		
		0.085	0.715499	0.1065	-1.61053	0.128	-1.96855		
		0.0855	1.07318	0.107	-0.357817	0.1285	-1.96855		
		0.086	1.252	0.1075	0	0.129	-1.78954		
		0.0865	1.96719	0.108	0.357772	0.1295	-1.61053		
		0.087	2.86091	0.1085	0.715499	0.13	-2.14758		
		0.0875	4.11166	0.109	0.894346	0.1305	-2.50567		
		0.088	5.36185	0.1095	0.894346	0.131	-2.32662		
		0.0885	6.78996	0.11	0.715499	0.1315	-1.96855		

Gauge40_4 Time msec	Gauge40_4 Stress MPa	Gauge40_4 Time msec	Gauge40_4 Stress MPa	Gauge40_4 Time msec	Gauge40_4 Stress MPa	Gauge40_4 Time msec	Gauge40_4 Stress MPa	Gauge40_5 Time msec	Gauge40_5 Stress MPa
0.16	0.177523	0.1815	0.177523	0.203	-3.37507	0.2245	-3.55282	0.16	0.536641
0.1605	0	0.182	0.355036	0.2035	-3.19733	0.225	-3.73057	0.1605	0.715499
0.161	0.177523	0.1825	0.355036	0.204	-2.8419	0.2255	-3.73057	0.161	0.536641
0.1615	0.177523	0.183	0.177523	0.2045	-2.66419	0.226	-3.73057	0.1615	0.715499
0.162	0.355036	0.1835	0.355036	0.205	-2.8419	0.2265	-3.90834	0.162	0.715499
0.1625	0.177523	0.184	0.355036	0.2055	-3.01961	0.227	-3.90834	0.1625	0.536641
0.163	0.355036	0.1845	0.710027	0.206	-3.37507	0.2275	-4.08612	0.163	0.715499
0.1635	0	0.185	0.355036	0.2065	-3.73057	0.228	-3.90834	0.1635	0.536641
0.164	0	0.1855	0.887505	0.207	-4.44172	0.2285	-4.08612	0.164	0.357772
0.1645	0	0.186	0.887505	0.2075	-4.79736	0.229	-4.08612	0.1645	0.715499
0.165	0.177523	0.1865	1.24243	0.208	-5.15304	0.2295	-4.08612	0.165	0.715499
0.1655	0	0.187	1.41987	0.2085	-5.3309	0.23	-4.44172	0.1655	0.536641
0.166	0	0.1875	2.12954	0.209	-5.50877	0.2305	-4.08612	0.166	0.715499
0.1665	0.355036	0.188	2.66168	0.2095	-5.68665	0.231	-4.44172	0.1665	0.715499
0.167	0.532537	0.1885	2.83903	0.21	-5.68665	0.2315	-4.26392	0.167	0.536641
0.1675	0.177523	0.189	3.01638	0.2105	-5.50877			0.1675	0.715499
0.168	0.177523	0.1895	2.83903	0.211	-5.50877			0.168	0.536641
0.1685	0.177523	0.19	3.01638	0.2115	-5.3309			0.1685	0.536641
0.169	0.177523	0.1905	2.83903	0.212	-5.3309			0.169	0.715499
0.1695	0	0.191	2.30693	0.2125	-4.97519			0.1695	0.715499
0.17	0	0.1915	1.41987	0.213	-4.79736			0.17	0.357772
0.1705	0.177523	0.192	0.710027	0.2135	-4.61953			0.1705	0.178892
0.171	0	0.1925	0.532537	0.214	-4.44172			0.171	0.357772
0.1715	0	0.193	0.177523	0.2145	-4.44172			0.1715	0.357772
0.172	0	0.1935	0	0.215	-4.08612			0.172	0.357772
0.1725	0	0.194	-0.35508	0.2155	-3.73057			0.1725	0
0.173	-0.177535	0.1945	-0.887785	0.216	-3.55282			0.173	0.178892
0.1735	0.177523	0.195	-1.42059	0.2165	-3.37507			0.1735	0.178892
0.174	0.177523	0.1955	-1.77585	0.217	-3.19733			0.174	0
0.1745	0	0.196	-2.13115	0.2175	-3.01961			0.1745	0
0.175	0	0.1965	-2.4865	0.218	-3.01961			0.175	0.178892
0.1755	-0.177535	0.197	-2.66419	0.2185	-2.8419			0.1755	0.357772
0.176	0	0.1975	-3.19733	0.219	-2.8419			0.176	0.178892
0.1765	0	0.198	-3.19733	0.2195	-2.66419			0.1765	0.178892
0.177	0	0.1985	-3.55282	0.22	-3.01961			0.177	0.178892
0.1775	0	0.199	-3.55282	0.2205	-3.01961			0.1775	0
0.178	-0.177535	0.1995	-3.73057	0.221	-2.8419			0.178	0
0.1785	-0.177535	0.2	-4.08612	0.2215	-3.01961			0.1785	0
0.179	0	0.2005	-4.44172	0.222	-3.19733			0.179	0.178892
0.1795	0	0.201	-4.26392	0.2225	-3.37507			0.1795	0.178892
0.18	0	0.2015	-4.26392	0.223	-3.55282			0.18	0.178892
0.1805	0.177523	0.202	-4.26392	0.2235	-3.55282			0.1805	0
0.181	0	0.2025	-3.73057	0.224	-3.73057			0.181	0.178892

Gauge40_5 Time msec	Gauge40_5 Stress MPa	Gauge40_5 Time msec	Gauge40_5 Stress MPa	Gauge40_5 Time msec	Gauge40_5 Stress MPa	Gauge40_6 Time msec	Gauge40_6 Stress MPa	Gauge40_6 Time msec	Gauge40_6 Stress MPa
0.1815	0	0.203	-1.61053	0.2245	2.32471	0.2205	0	0.242	-0.179248
0.182	0.178892	0.2035	-2.32662	0.225	2.32471	0.221	0	0.2425	-0.358508
0.1825	0	0.204	-2.68473	0.2255	1.96719	0.2215	-0.179248	0.243	-0.179248
0.183	0	0.2045	-3.22198	0.226	1.43082	0.222	0	0.2435	-0.179248
0.1835	0.178892	0.205	-3.5802	0.2265	1.60962	0.2225	0	0.244	0
0.184	0.178892	0.2055	-4.29678	0.227	1.07318	0.223	-0.179248	0.2445	0
0.1845	0.178892	0.206	-4.47595	0.2275	0.715499	0.2235	-0.179248	0.245	0.179237
0.185	0.357772	0.2065	-4.83433	0.228	0.178892	0.224	-0.179248	0.2455	0
0.1855	0.357772	0.207	-5.37199	0.2285	-0.178903	0.2245	0	0.246	0
0.186	0.357772	0.2075	-5.90974	0.229	-0.536742	0.225	0	0.2465	0
0.1865	0.357772	0.208	-5.90974	0.2295	-1.07359	0.2255	0	0.247	0
0.187	0.357772	0.2085	-5.90974	0.23	-1.43154	0.226	-0.179248	0.2475	0
0.1875	0.715499	0.209	-5.90974	0.2305	-1.78954	0.2265	0	0.248	-0.179248
0.188	0.715499	0.2095	-5.90974	0.231	-1.78954	0.227	0	0.2485	0
0.1885	0.715499	0.21	-5.73048	0.2315	-2.32662	0.2275	-0.179248	0.249	0
0.189	1.252	0.2105	-5.55123	0.232	-2.32662	0.228	-0.179248	0.2495	0
0.1895	1.43082	0.211	-5.19276	0.2325	-3.04288	0.2285	-0.179248	0.25	0.179237
0.19	1.60962	0.2115	-5.19276	0.233	-2.8638	0.229	-0.179248	0.2505	0
0.1905	1.78841	0.212	-4.47595	0.2335	-3.40108	0.2295	-0.179248	0.251	0
0.191	2.14596	0.2125	-4.11762	0.234	-3.40108	0.23	-0.179248	0.2515	0
0.1915	2.32471	0.213	-3.5802	0.2345	-3.93847	0.2305	-0.179248	0.252	0
0.192	2.32471	0.2135	-3.04288	0.235	-4.11762	0.231	-0.179248	0.2525	0
0.1925	2.32471	0.214	-2.68473	0.2355	-4.29678	0.2315	-0.358508	0.253	0
0.193	2.50346	0.2145	-2.32662	0.236	-4.11762	0.232	-0.179248	0.2535	0.358463
0.1935	2.50346	0.215	-1.61053	0.2365	-4.29678	0.2325	-0.179248	0.254	0.179237
0.194	2.32471	0.2155	-1.61053	0.237	-4.29678	0.233	-0.179248	0.2545	0.179237
0.1945	2.50346	0.216	-0.715679	0.2375	-4.29678	0.2335	-0.179248	0.255	0.358463
0.195	2.32471	0.2165	-0.178903	0.238	-4.47595	0.234	0	0.2555	0.179237
0.1955	2.32471	0.217	0.178892	0.2385	-4.47595	0.2345	-0.358508	0.256	0.179237
0.196	2.68219	0.2175	0.357772	0.239	-4.47595	0.235	-0.179248	0.2565	0.358463
0.1965	3.03963	0.218	0.715499	0.2395	-4.65514	0.2355	0	0.257	0.358463
0.197	2.86091	0.2185	1.07318	0.24	-4.65514	0.236	-0.179248	0.2575	0.358463
0.1975	3.03963	0.219	1.252	0.2405	-4.65514	0.2365	-0.358508	0.258	0.358463
0.198	3.03963	0.2195	1.60962	0.241	-4.65514	0.237	0	0.2585	0.358463
0.1985	2.68219	0.22	1.96719	0.2415	-4.65514	0.2375	-0.179248	0.259	0.358463
0.199	2.32471	0.2205	2.14596	0.242	-4.29678	0.238	-0.358508	0.2595	0.358463
0.1995	1.60962	0.221	2.32471	0.2425	-4.47595	0.2385	-0.179248	0.26	0.358463
0.2	1.252	0.2215	2.50346	0.243	-4.47595	0.239	0	0.2605	0.179237
0.2005	0.715499	0.222	2.86091	0.2435	-4.29678	0.2395	-0.179248	0.261	0.537677
0.201	0.357772	0.2225	2.86091			0.24	0	0.2615	0.358463
0.2015	-0.178903	0.223	2.86091			0.2405	-0.179248	0.262	0.537677
0.202	-0.536742	0.2235	2.50346			0.241	-0.358508	0.2625	0.358463
0.2025	-1.07359	0.224	2.50346			0.2415	-0.179248	0.263	0.537677

Gauge40_6 Time msec	Gauge40_6 Stress MPa	Gauge40_6 Time msec	Gauge40_6 Stress MPa	Gauge40_6 Time msec	Gauge40_6 Stress MPa	Gauge40_6 Time msec	Gauge40_6 Stress MPa	Gauge40_6 Time msec	Gauge40_6 Stress MPa	Gauge40_6 Time msec	Gauge40_6 Stress MPa
0.2635	0.537677	0.285	-0.179248	0.3065	1.43358	0.328	0.358463	0.3495	3.40357	0.371	6.62425
0.264	0.358463	0.2855	-0.179248	0.307	1.43358	0.3285	0.537677	0.35	3.22454	0.3715	6.26658
0.2645	0.537677	0.286	-0.179248	0.3075	1.97099	0.329	0.71688	0.3505	3.5826	0.372	6.44542
0.265	0.358463	0.2865	-0.179248	0.308	2.3292	0.3295	0.71688	0.351	3.76161	0.3725	6.44542
0.2655	0.537677	0.287	-0.358508	0.3085	2.50829	0.33	0.896072	0.3515	3.76161	0.373	6.44542
0.266	0.358463	0.2875	-0.358508	0.309	2.68737	0.3305	1.07525	0.352	3.94061	0.3735	6.80307
0.2665	0.537677	0.288	0	0.3095	3.04549	0.331	1.07525	0.3525	4.1196	0.374	6.44542
0.267	0.358463	0.2885	0	0.31	3.04549	0.3315	1.25442	0.353	4.29857	0.3745	6.44542
0.2675	0.537677	0.289	0	0.3105	3.22454	0.332	1.43358	0.3535	4.47754	0.375	6.44542
0.268	0.358463	0.2895	0.179237	0.311	3.04549	0.3325	1.43358	0.354	4.47754	0.3755	6.44542
0.2685	0.358463	0.29	0	0.3115	3.22454	0.333	1.43358	0.3545	4.65649	0.376	6.44542
0.269	0.358463	0.2905	0	0.312	3.04549	0.3335	1.61273	0.355	4.83544	0.3765	6.62425
0.2695	0.358463	0.291	0	0.3125	3.22454	0.334	1.61273	0.3555	4.65649	0.377	6.26658
0.27	0.358463	0.2915	-0.179248	0.313	2.86644	0.3345	1.79186	0.356	4.83544	0.3775	6.44542
0.2705	0.358463	0.292	0	0.3135	2.50829	0.335	1.79186	0.3565	4.83544	0.378	6.26658
0.271	0.537677	0.2925	-0.358508	0.314	1.97099	0.3355	1.61273	0.357	5.01437	0.3785	6.80307
0.2715	0.537677	0.293	0.179237	0.3145	1.43358	0.336	1.79186	0.3575	5.01437	0.379	6.44542
0.272	0.71688	0.2935	0.179237	0.315	1.07525	0.3365	1.79186	0.358	5.01437	0.3795	6.44542
0.2725	0.71688	0.294	0.358463	0.3155	0.71688	0.337	1.97099	0.3585	5.19329	0.38	6.44542
0.273	0.358463	0.2945	0.896072	0.316	0.358463	0.3375	1.61273	0.359	5.19329	0.3805	6.44542
0.2735	0.537677	0.295	1.25442	0.3165	0.358463	0.338	1.79186	0.3595	5.3722	0.381	6.62425
0.274	0.537677	0.2955	1.25442	0.317	-0.179248	0.3385	1.79186	0.36	5.5511	0.3815	6.44542
0.2745	0.71688	0.296	1.79186	0.3175	-0.358508	0.339	1.61273	0.3605	5.5511	0.382	6.62425
0.275	0.537677	0.2965	1.79186	0.318	-0.717061	0.3395	1.61273	0.361	5.5511	0.3825	6.98188
0.2755	0.358463	0.297	1.79186	0.3185	-0.717061	0.34	1.61273	0.3615	5.5511	0.383	6.80307
0.276	0.537677	0.2975	2.3292	0.319	-0.896354	0.3405	1.61273	0.362	5.72999	0.3835	6.80307
0.2765	0.71688	0.298	2.3292	0.3195	-1.07566	0.341	1.61273	0.3625	5.72999	0.384	6.98188
0.277	0.537677	0.2985	2.3292	0.32	-1.25497	0.3415	1.61273	0.363	5.5511		
0.2775	0.537677	0.299	2.50829	0.3205	-1.25497	0.342	1.43358	0.3635	5.72999		
0.278	0.537677	0.2995	2.50829	0.321	-1.25497	0.3425	1.79186	0.364	5.72999		
0.2785	0.179237	0.3	2.50829	0.3215	-1.07566	0.343	1.97099	0.3645	5.72999		
0.279	0.358463	0.3005	2.3292	0.322	-1.07566	0.3435	1.79186	0.365	5.72999		
0.2795	0.358463	0.301	2.1501	0.3225	-1.07566	0.344	2.1501	0.3655	5.90886		
0.28	0.358463	0.3015	1.97099	0.323	-0.896354	0.3445	1.61273	0.366	5.90886		
0.2805	0.179237	0.302	1.97099	0.3235	-0.896354	0.345	1.97099	0.3665	6.06773		
0.281	0.179237	0.3025	1.61273	0.324	-0.717061	0.3455	1.97099	0.367	6.44542		
0.2815	0.179237	0.303	1.25442	0.3245	-0.537779	0.346	2.3292	0.3675	6.26658		
0.282	0.179237	0.3035	1.25442	0.325	-0.537779	0.3465	2.3292	0.368	6.26658		
0.2825	0	0.304	1.25442	0.3255	-0.358508	0.347	2.68737	0.3685	6.62425		
0.283	0	0.3045	1.07525	0.326	-0.179248	0.3475	2.50829	0.369	6.62425		
0.2835	0.179237	0.305	1.07525	0.3265	0	0.348	2.68737	0.3695	6.80307		
0.284	0	0.3055	1.25442	0.327	0.179237	0.3485	3.22454	0.37	6.62425		
0.2845	0	0.306	1.43358	0.3275	0.358463	0.349	3.40357	0.3705	6.62425		

Gauge41_L1 Time msec	Gauge41_L1 Stress MPa	Gauge41_L1 Time msec	Gauge41_L1 Stress MPa	Gauge41_L1 Time msec	Gauge41_L1 Stress MPa	Gauge41_L1 Time msec	Gauge41_L1 Stress MPa	Gauge41_L1 Time msec	Gauge41_L1 Stress MPa
-0.01975	0	-0.009	0	0.00175	833.47	0.0125	-38.549	0.02325	-217.818
-0.0195	0	-0.00875	0	0.002	776.732	0.01275	-38.549	0.0235	-217.818
-0.01925	0	-0.0085	0	0.00225	748.914	0.013	-38.549	0.02375	-238.322
-0.019	0	-0.00825	0	0.0025	748.914	0.01325	-38.549	0.024	-136.971
-0.01875	0	-0.008	0	0.00275	748.914	0.0135	-38.549	0.02425	-197.43
-0.0185	0	-0.00775	0	0.003	667.831	0.01375	-38.549	0.0245	-197.43
-0.01825	0	-0.0075	0	0.00325	590.6	0.014	-38.549	0.02475	-217.818
-0.018	0	-0.00725	0	0.0035	449.253	0.01425	-38.549	0.025	-217.818
-0.01775	0	-0.007	-19.2159	0.00375	366.024	0.0145	-38.549	0.02525	-217.818
-0.0175	19.0988	-0.00675	0	0.004	292.741	0.01475	-38.549	0.0255	-197.43
-0.01725	0	-0.0065	0	0.00425	185.717	0.015	-38.549	0.02575	-136.971
-0.017	0	-0.00625	-19.2159	0.0045	149.511	0.01525	-57.9992	0.026	-217.818
-0.01675	0	-0.006	0	0.00475	149.511	0.0155	-57.9992	0.02625	-217.818
-0.0165	0	-0.00575	0	0.005	149.511	0.01575	-97.2511	0.0265	-217.818
-0.01625	0	-0.0055	0	0.00525	185.717	0.016	-97.2511	0.02675	-217.818
-0.016	0	-0.00525	0	0.0055	-19.2159	0.01625	-97.2511	0.027	-238.322
-0.01575	0	-0.005	0	0.00575	112.836	0.0165	-97.2511	0.02725	-238.322
-0.0155	19.0988	-0.00475	0	0.006	75.6924	0.01675	-97.2511	0.0275	-238.322
-0.01525	0	-0.0045	0	0.00625	94.3227	0.017	-97.2511	0.02775	-217.818
-0.015	0	-0.00425	0	0.0065	112.836	0.01725	-97.2511	0.028	-238.322
-0.01475	0	-0.004	0	0.00675	38.0805	0.0175	-77.5666	0.02825	-217.818
-0.0145	0	-0.00375	-19.2159	0.007	56.945	0.01775	-117.053	0.0285	-238.322
-0.01425	56.945	-0.0035	0	0.00725	94.3227	0.018	-117.053	0.02875	-238.322
-0.014	38.0805	-0.00325	0	0.0075	38.0805	0.01825	-117.053	0.029	-238.322
-0.01375	-19.2159	-0.003	0	0.00775	38.0805	0.0185	-117.053	0.02925	-294.901
-0.0135	-19.2159	-0.00275	0	0.008	94.3227	0.01875	-97.2511	0.0295	-238.322
-0.01325	-19.2159	-0.0025	0	0.00825	56.945	0.019	-117.053	0.02975	-217.818
-0.013	0	-0.00225	0	0.0085	19.0988	0.01925	-157.007	0.03	-217.818
-0.01275	0	-0.002	0	0.00875	38.0805	0.0195	-157.007	0.03025	-217.818
-0.0125	-19.2159	-0.00175	0	0.009	0	0.01975	-177.16	0.0305	-217.818
-0.01225	-19.2159	-0.0015	0	0.00925	56.945	0.02	-157.007	0.03075	-217.818
-0.012	-19.2159	-0.00125	0	0.0095	38.0805	0.02025	-177.16	0.031	-197.43
-0.01175	0	-0.001	0	0.00975	-38.549	0.0205	-157.007	0.03125	-177.16
-0.0115	0	-0.00075	0	0.01	38.0805	0.02075	-57.9992	0.0315	-157.007
-0.01125	0	-0.0005	0	0.01025	19.0988	0.021	-136.971	0.03175	-117.053
-0.011	-19.2159	-0.00025	19.0988	0.0105	38.0805	0.02125	-157.007	0.032	-57.9992
-0.01075	0	0	19.0988	0.01075	38.0805	0.0215	-157.007	0.03225	-97.2511
-0.0105	0	0.00025	38.0805	0.011	-38.549	0.02175	-177.16	0.0325	-97.2511
-0.01025	0	0.0005	131.232	0.01125	0	0.022	-177.16	0.03275	-97.2511
-0.01	0	0.00075	694.45	0.0115	0	0.02225	-197.43	0.033	-97.2511
-0.00975	0	0.001	833.47	0.01175	0	0.0225	-197.43	0.03325	-97.2511
-0.0095	0	0.00125	833.47	0.012	-19.2159	0.02275	-217.818	0.0335	-97.2511
-0.00925	-19.2159	0.0015	862.362	0.01225	0	0.023	-217.818	0.03375	-97.2511

Gauge41_L1 Time msec	Gauge41_L1 Stress MPa	Gauge41_L2 Time msec	Gauge41_L2 Stress MPa	Gauge41_L2 Time msec	Gauge41_L2 Stress MPa	Gauge41_L3 Time msec	Gauge41_L3 Stress MPa	Gauge41_L3 Time msec	Gauge41_L3 Stress MPa
0.034	-97.2511	0.0275	0.352341	0.049	-0.352385	0.0335	0.5295	0.055	0.176511
0.03425	-97.2511	0.028	0.528495	0.0495	-0.352385	0.034	0.176511	0.0555	0.176511
0.0345	-117.053	0.0285	0.176176	0.05	-0.176187	0.0345	0.5295	0.056	0.353011
0.03475	-117.053	0.029	0.352341	0.0505	-0.352385	0.035	0.5295	0.0565	0.353011
0.035	-117.053	0.0295	0.352341	0.051	-0.352385	0.0355	0.705977	0.057	0.5295
0.03525	-117.053	0.03	0.352341	0.0515	-0.528595	0.036	0.353011	0.0575	0.5295
0.0355	-136.971	0.0305	0.352341	0.052	-0.352385	0.0365	0.705977	0.058	1.41178
0.03575	-136.971	0.031	0.352341	0.0525	-0.176187	0.037	0.705977	0.0585	3.7044
0.036	-136.971	0.0315	0.528495	0.053	-0.176187	0.0375	0.5295	0.059	9.8675
0.03625	-136.971	0.032	0.176176	0.0535	-0.176187	0.038	0.5295	0.0595	25.1282
0.0365	-157.007	0.0325	0.352341	0.054	-0.176187	0.0385	0.176511	0.06	28.9739
0.03675	-157.007	0.033	0.352341	0.0545	-0.176187	0.039	0.353011	0.0605	20.0507
0.037	-177.16	0.0335	0.176176	0.055	0.176176	0.0395	0.353011	0.061	9.51569
0.03725	-177.16	0.034	0	0.0555	0.352341	0.04	0.353011	0.0615	4.58567
0.0375	-177.16	0.0345	0	0.056	0.704638	0.0405	0.176511	0.062	5.64284
0.03775	-177.16	0.035	0	0.0565	1.76126	0.041	0.176511	0.0625	6.34739
0.038	-177.16	0.0355	0.176176	0.057	6.15956	0.0415	0	0.063	5.99514
0.03825	-177.16	0.036	0.352341	0.0575	13.7084	0.042	0.176511	0.0635	3.35181
0.0385	-197.43	0.0365	0	0.058	20.3624	0.0425	0.176511	0.064	0
0.03875	-177.16	0.037	0	0.0585	26.3024	0.043	0	0.0645	-3.00239
0.039	-177.16	0.0375	0.176176	0.059	7.91694	0.0435	0.176511	0.065	-4.41639
0.03925	-157.007	0.038	0.176176	0.0595	-14.4842	0.044	0	0.0655	-4.06282
0.0395	-177.16	0.0385	0.176176	0.06	-15.0155	0.0445	0.176511	0.066	-4.2396
0.03975	-177.16	0.039	0.176176	0.0605	-15.1926	0.045	0	0.0665	-3.88605
0.04	-177.16	0.0395	0.176176	0.061	-15.0155	0.0455	0	0.067	-3.1791
0.04025	-136.971	0.04	0.352341	0.0615	-14.8384	0.046	0.176511	0.0675	-2.119
0.0405	-157.007	0.0405	0	0.062	-15.0155	0.0465	0.176511	0.068	-1.41249
0.04075	-177.16	0.041	0.352341	0.0625	-15.0155	0.047	0.176511	0.0685	-0.706155
0.041	-177.16	0.0415	0.176176	0.063	-15.0155	0.0475	0	0.069	-0.176522
0.04125	-177.16	0.042	0.352341	0.0635	-15.0155	0.048	0	0.0695	0.176511
0.0415	-177.16	0.0425	0.176176	0.064	-15.0155	0.0485	0.176511	0.07	0.882444
		0.043	0	0.0645	-15.0155	0.049	0	0.0705	1.76461
		0.0435	0	0.065	-15.0155	0.0495	0	0.071	2.47014
		0.044	0	0.0655	-15.0155	0.05	0	0.0715	4.05694
		0.0445	0	0.066	-14.8384	0.0505	0	0.072	5.11431
		0.045	-0.176187	0.0665	-14.8384	0.051	0	0.0725	5.99514
		0.0455	0	0.067	-15.0155	0.0515	0	0.073	6.34739
		0.046	-0.176187	0.0675	-15.0155	0.052	0	0.0735	6.87569
		0.0465	-0.176187			0.0525	0	0.074	6.6996
		0.047	0			0.053	0	0.0745	6.6996
		0.0475	-0.176187			0.0535	0	0.075	6.87569
		0.048	-0.176187			0.054	0	0.0755	6.5235
		0.0485	-0.352385			0.0545	0.176511	0.076	6.5235

Gauge41_3 Time msec	Gauge41_3 Stress MPa	Gauge41_3 Time msec	Gauge41_3 Stress MPa	Gauge41_3 Time msec	Gauge41_3 Stress MPa	Gauge41_3 Time msec	Gauge41_3 Stress MPa	Gauge41_3 Time msec	Gauge41_3 Stress MPa
0.0765	6.17127	0.098	1.41178	0.1195	2.6465	0.141	1.0589	0.1625	1.5882
0.077	6.17127	0.0985	1.41178	0.12	2.29378	0.1415	0.882444	0.163	1.76461
0.0775	5.99514	0.099	1.76461	0.1205	2.47014	0.142	1.0589	0.1635	2.1174
0.078	5.64284	0.0995	1.41178	0.121	2.47014	0.1425	1.41178	0.164	2.1174
0.0785	5.29049	0.1	1.5882	0.1215	2.47014	0.143	1.5882	0.1645	2.29378
0.079	4.76189	0.1005	1.23534	0.122	1.5882	0.1435	1.76461	0.165	2.1174
0.0795	4.05694	0.101	1.23534	0.1225	2.29378	0.144	1.76461	0.1655	2.47014
0.08	2.99917	0.1015	1.0589	0.123	2.29378	0.1445	1.94101	0.166	2.47014
0.0805	2.6465	0.102	1.41178	0.1235	2.29378	0.145	1.76461	0.1665	2.82284
0.081	1.94101	0.1025	1.23534	0.124	2.29378	0.1455	1.94101	0.167	2.99917
0.0815	1.0589	0.103	0.882444	0.1245	2.1174	0.146	2.1174	0.1675	2.82284
0.082	0.5295	0.1035	0.882444	0.125	2.1174	0.1465	2.29378	0.168	2.99917
0.0825	0	0.104	0.882444	0.1255	1.94101	0.147	2.6465	0.1685	3.1755
0.083	-0.176522	0.1045	0.5295	0.126	1.94101	0.1475	2.47014	0.169	3.1755
0.0835	-0.5296	0.105	0.353011	0.1265	2.1174	0.148	2.6465	0.1695	3.1755
0.084	-0.353055	0.1055	0.353011	0.127	2.1174	0.1485	2.6465	0.17	3.1755
0.0845	-0.353055	0.106	0.5295	0.1275	1.94101	0.149	2.82284	0.1705	2.99917
0.085	-0.5296	0.1065	0.705977	0.128	1.94101	0.1495	2.82284	0.171	2.99917
0.0855	-0.706155	0.107	0.5295	0.1285	1.94101	0.15	2.99917	0.1715	2.99917
0.086	-0.706155	0.1075	0.882444	0.129	1.94101	0.1505	2.99917	0.172	2.6465
0.0865	-0.882721	0.108	0.705977	0.1295	1.94101	0.151	2.82284	0.1725	2.6465
0.087	-0.5296	0.1085	1.23534	0.13	1.94101	0.1515	2.99917	0.173	2.6465
0.0875	-0.706155	0.109	1.41178	0.1305	2.1174	0.152	2.99917	0.1735	2.47014
0.088	-0.706155	0.1095	1.5882	0.131	2.29378	0.1525	2.99917	0.174	2.47014
0.0885	-0.706155	0.11	1.94101	0.1315	2.1174	0.153	2.99917	0.1745	2.29378
0.089	-0.5296	0.1105	2.1174	0.132	1.94101	0.1535	2.99917	0.175	2.29378
0.0895	-0.5296	0.111	2.29378	0.1325	2.29378	0.154	2.82284	0.1755	2.1174
0.09	-0.176522	0.1115	2.47014	0.133	2.29378	0.1545	2.6465	0.176	2.29378
0.0905	0.176511	0.112	2.29378	0.1335	2.29378	0.155	2.6465	0.1765	2.1174
0.091	0.353011	0.1125	2.6465	0.134	2.47014	0.1555	2.6465	0.177	2.1174
0.0915	0.5295	0.113	2.6465	0.1345	2.47014	0.156	2.47014	0.1775	1.94101
0.092	0.705977	0.1135	2.47014	0.135	1.94101	0.1565	2.47014	0.178	2.1174
0.0925	0.705977	0.114	2.6465	0.1355	2.1174	0.157	2.29378	0.1785	2.1174
0.093	0.882444	0.1145	3.1755	0.136	2.1174	0.1575	2.29378	0.179	2.1174
0.0935	1.0589	0.115	2.82284	0.1365	1.23534	0.158	2.29378	0.1795	1.94101
0.094	1.23534	0.1155	2.82284	0.137	1.41178	0.1585	1.94101	0.18	2.1174
0.0945	1.23534	0.116	2.82284	0.1375	1.5882	0.159	2.1174	0.1805	2.29378
0.095	1.23534	0.1165	2.82284	0.138	1.41178	0.1595	1.94101	0.181	2.1174
0.0955	1.5882	0.117	2.82284	0.1385	1.5882	0.16	1.76461	0.1815	2.6465
0.096	1.41178	0.1175	2.82284	0.139	1.0589	0.1605	1.94101	0.182	2.6465
0.0965	1.23534	0.118	2.82284	0.1395	1.0589	0.161	1.5882	0.1825	2.6465
0.097	1.23534	0.1185	2.82284	0.14	0.882444	0.1615	1.5882	0.183	2.29378
0.0975	1.41178	0.119	2.47014	0.1405	1.23534	0.162	1.5882	0.1835	2.29378

Gauge41_3 Time msec	Gauge41_3 Stress MPa	Gauge41_3 Time msec	Gauge41_3 Stress MPa	Gauge41_3 Time msec	Gauge41_3 Stress MPa	Gauge41_4 Time msec	Gauge41_4 Stress MPa	Gauge41_4 Time msec	Gauge41_4 Stress MPa
0.184	2.6465	0.2055	2.99917	0.227	2.99917	0.0915	0.356399	0.113	0
0.1845	2.6465	0.206	3.35181	0.2275	2.99917	0.092	0.356399	0.1135	-0.178216
0.185	2.47014	0.2065	2.99917	0.228	2.82284	0.0925	0.890912	0.114	0
0.1855	2.47014	0.207	2.99917	0.2285	2.6465	0.093	0.178205	0.1145	0
0.186	2.47014	0.2075	2.82284	0.229	2.82284	0.0935	0	0.115	0
0.1865	2.82284	0.208	3.1755	0.2295	2.6465	0.094	0	0.1155	-0.178216
0.187	2.47014	0.2085	2.6465	0.23	2.47014	0.0945	0	0.116	-0.178216
0.1875	2.6465	0.209	2.6465	0.2305	2.47014	0.095	0	0.1165	-0.178216
0.188	2.6465	0.2095	2.82284	0.231	2.82284	0.0955	-0.178216	0.117	-0.178216
0.1885	2.82284	0.21	2.82284	0.2315	2.29378	0.096	0	0.1175	0
0.189	2.6465	0.2105	2.6465	0.232	2.1174	0.0965	0	0.118	0
0.1895	2.6465	0.211	2.6465	0.2325	2.1174	0.097	-0.178216	0.1185	-0.178216
0.19	2.82284	0.2115	2.47014	0.233	2.29378	0.0975	-0.178216	0.119	0.178205
0.1905	2.6465	0.212	2.47014	0.2335	2.1174	0.098	-0.178216	0.1195	0.712752
0.191	2.6465	0.2125	2.47014	0.234	2.29378	0.0985	-0.178216	0.12	1.95964
0.1915	2.6465	0.213	2.29378	0.2345	2.1174	0.099	0	0.1205	462968
0.192	2.82284	0.2135	2.29378	0.235	2.29378	0.0995	-0.178216	0.121	8.3635
0.1925	2.82284	0.214	1.94101	0.2355	2.29378	0.1	-0.178216	0.1215	13.8663
0.193	2.82284	0.2145	1.41178	0.236	2.1174	0.1005	0	0.122	17.5679
0.1935	2.82284	0.215	1.94101	0.2365	2.29378	0.101	0	0.1225	15.8163
0.194	2.82284	0.2155	2.29378	0.237	2.29378	0.1015	0.178205	0.123	9.9622
0.1945	2.82284	0.216	2.29378	0.2375	2.29378	0.102	0	0.1235	5.34127
0.195	2.82284	0.2165	2.29378	0.238	2.29378	0.1025	0.178205	0.124	4.09587
0.1955	2.6465	0.217	2.29378	0.2385	2.29378	0.103	0.356399	0.1245	3.91792
0.196	2.6465	0.2175	2.47014	0.239	2.47014	0.1035	0.178205	0.125	2.64993
0.1965	2.6465	0.218	2.47014	0.2395	2.47014	0.104	0.178205	0.1255	1.2472
0.197	2.6465	0.2185	2.6465	0.24	2.6465	0.1045	0.356399	0.126	0.356399
0.1975	2.82284	0.219	2.6465	0.2405	2.6465	0.105	0.356399	0.1265	-0.178216
0.198	2.6465	0.2195	2.82284	0.241	2.82284	0.1055	0.356399	0.127	-1.06947
0.1985	2.47014	0.22	2.99917	0.2415	2.99917	0.106	0.356399	0.1275	-1.24775
0.199	2.47014	0.2205	2.99917	0.242	2.99917	0.1065	0.534581	0.128	-0.712932
0.1995	2.47014	0.221	3.1755	0.2425	3.1755	0.107	0.356399	0.1285	-0.356443
0.2	2.6465	0.2215	3.1755	0.243	3.1755	0.1075	0.356399	0.129	0.178205
0.2005	2.6465	0.222	3.1755	0.2435	3.1755	0.108	0.356399	0.1295	0.712752
0.201	2.6465	0.2225	3.1755	0.244	3.1755	0.1085	0.534581	0.13	1.06906
0.2015	2.99917	0.223	3.1755	0.2445	3.1755	0.109	0.534581	0.1305	1.2472
0.202	2.82284	0.2235	3.1755	0.245	3.1755	0.1095	0.356399	0.131	1.78154
0.2025	2.99917	0.224	3.35181	0.2455	3.35181	0.11	0.178205	0.1315	1.78154
0.203	2.82284	0.2245	3.1755	0.246	3.1755	0.1105	0.178205	0.132	1.60344
0.2035	2.82284	0.225	3.1755	0.2465	3.1755	0.111	0.356399	0.1325	1.78154
0.204	2.82284	0.2255	3.1755	0.247	3.1755	0.1115	0.178205	0.133	2.13772
0.2045	2.99917	0.226	3.1755	0.2475	3.1755	0.112	0.178205	0.1335	2.49365
0.205	3.1755	0.2265	3.1755	0.248	3.1755	0.1125	0	0.134	2.49385

Gauge41_4 Time msec	Gauge41_4 Stress MPa	Gauge41_4 Time msec	Gauge41_4 Stress MPa	Gauge41_4 Time msec	Gauge41_4 Stress MPa	Gauge41_4 Time msec	Gauge41_4 Stress MPa	Gauge41_4 Time msec	Gauge41_4 Stress MPa
0.1345	2.49385	0.156	-2.31768	0.1775	-0.712932	0.199	1.06906	0.2205	1.78154
0.135	2.31579	0.1565	-2.49605	0.178	-0.712932	0.1995	1.06906	0.221	1.78154
0.1355	2.49385	0.157	-2.49605	0.1785	-0.534682	0.2	1.42533	0.2215	1.78154
0.136	2.84993	0.1575	-2.8528	0.179	-0.712932	0.2005	1.42533	0.222	1.95964
0.1365	3.20597	0.158	-1.96099	0.1795	-0.356443	0.201	1.95964	0.2225	1.95964
0.137	3.20597	0.1585	-1.78267	0.18	-0.534682	0.2015	1.95964		
0.1375	3.20597	0.159	-2.13933	0.1805	-0.534682	0.202	2.13772		
0.138	3.02796	0.1595	-2.13933	0.181	-0.534682	0.2025	2.31579		
0.1385	2.31579	0.16	-2.13933	0.1815	-0.356443	0.203	2.31579		
0.139	2.13772	0.1605	-1.60435	0.182	-0.178216	0.2035	2.6719		
0.1395	1.78154	0.161	-1.78267	0.1825	-0.356443	0.204	2.6719		
0.14	1.78154	0.1615	-1.96099	0.183	-0.356443	0.2045	2.6719		
0.1405	1.60344	0.162	-1.96099	0.1835	-0.534682	0.205	2.49385		
0.141	1.78154	0.1625	-1.96099	0.184	-0.178216	0.2055	2.49385		
0.1415	1.60344	0.163	-1.78267	0.1845	-0.356443	0.206	2.6719		
0.142	1.60344	0.1635	-1.78267	0.185	-0.356443	0.2065	2.6719		
0.1425	1.60344	0.164	-1.78267	0.1855	-0.356443	0.207	2.49385		
0.143	1.2472	0.1645	-1.78267	0.186	-0.178216	0.2075	2.49385		
0.1435	0.890912	0.165	-1.78267	0.1865	-0.356443	0.208	2.6719		
0.144	0.534581	0.1655	-1.78267	0.187	-0.356443	0.2085	2.6719		
0.1445	0.178205	0.166	-1.78267	0.1875	-0.356443	0.209	2.49385		
0.145	0.178205	0.1665	-1.78267	0.188	-0.534682	0.2095	2.6719		
0.1455	0	0.167	-1.78267	0.1885	-0.356443	0.21	2.49385		
0.146	-0.178216	0.1675	-1.60435	0.189	-0.534682	0.2105	2.49385		
0.1465	-0.356443	0.168	-1.60435	0.1895	-0.356443	0.211	2.13772		
0.147	-0.356443	0.1685	-1.60435	0.19	-0.178216	0.2115	2.13772		
0.1475	-0.534682	0.169	-1.42604	0.1905	-0.356443	0.212	1.78154		
0.148	-0.712932	0.1695	-1.60435	0.191	-0.178216	0.2125	1.95964		
0.1485	-0.712932	0.17	-1.78267	0.1915	-0.356443	0.213	2.13772		
0.149	-1.06947	0.1705	-1.42604	0.192	-0.356443	0.2135	2.13772		
0.1495	-1.60435	0.171	-1.60435	0.1925	-0.178216	0.214	1.95964		
0.15	-1.78267	0.1715	-1.42604	0.193	0	0.2145	1.78154		
0.1505	-1.78267	0.172	-1.24775	0.1935	0	0.215	1.60344		
0.151	-1.96099	0.1725	-1.24775	0.194	0	0.2155	1.60344		
0.1515	-1.78267	0.173	-1.24775	0.1945	0	0.216	1.78154		
0.152	-1.96099	0.1735	-1.24775	0.195	0	0.2165	1.78154		
0.1525	-1.96099	0.174	-1.24775	0.1955	0	0.217	1.95964		
0.153	-2.13933	0.1745	-1.06947	0.196	0	0.2175	1.78154		
0.1535	-1.96099	0.175	-1.06947	0.1965	0	0.218	1.78154		
0.154	-2.31768	0.1755	-0.891193	0.197	0.178205	0.2185	1.60344		
0.1545	-2.13933	0.176	-1.06947	0.1975	0.356399	0.219	1.78154		
0.155	-2.13933	0.1765	-0.891193	0.198	0.534581	0.2195	1.78154		
0.1555	-2.31768	0.177	-0.712932	0.1985	0.712752	0.22	1.78154		

Gauge41_5 Time msec	Gauge41_5 Stress MPa	Gauge41_5 Time msec	Gauge41_5 Stress MPa	Gauge41_5 Time msec	Gauge41_5 Stress MPa	Gauge41_5 Time msec	Gauge41_5 Stress MPa	Gauge41_5 Time msec	Gauge41_5 Stress MPa
0.0875	0.889206	0.109	0.533557	0.1305	0.355716	0.152	0.711387	0.1735	2.84447
0.088	0.889206	0.1095	0.355716	0.131	0.889206	0.1525	0.889206	0.174	2.66678
0.0885	1.06701	0.11	0.355716	0.1315	1.60037	0.153	0.889206	0.1745	2.84447
0.089	0.889206	0.1105	0.355716	0.132	2.84447	0.1535	1.06701	0.175	3.02216
0.0895	0.889206	0.111	0.355716	0.1325	3.73278	0.154	1.42259	0.1755	3.02216
0.09	0.711387	0.1115	0.355716	0.133	4.79838	0.1545	1.60037	0.176	3.37749
0.0905	0.533557	0.112	0.355716	0.1335	5.50856	0.155	1.77813	0.1765	3.37749
0.091	0.533557	0.1125	0.355716	0.134	5.86358	0.1555	2.13362	0.177	3.73278
0.0915	0.533557	0.113	0.177864	0.1345	6.21856	0.156	2.48907	0.1775	3.73278
0.092	1.06701	0.1135	0.177864	0.135	7.10581	0.1565	2.66678	0.178	3.91041
0.0925	1.06701	0.114	0	0.1355	7.63802	0.157	2.48907	0.1785	3.91041
0.093	0.533557	0.1145	0	0.136	7.8154	0.1575	2.84447	0.179	4.26563
0.0935	0.177864	0.115	0	0.1365	7.8154	0.158	3.55514	0.1795	4.44323
0.094	0.533557	0.1155	0	0.137	7.28322	0.1585	3.73278	0.18	4.44323
0.0945	0.355716	0.116	0	0.1375	6.57349	0.159	3.55514	0.1805	4.26563
0.095	0.355716	0.1165	0	0.138	6.04108	0.1595	3.73278	0.181	4.44323
0.0955	0.355716	0.117	0	0.1385	5.50856	0.16	4.08803	0.1815	4.44323
0.096	0.355716	0.1175	0	0.139	4.62081	0.1605	4.08803	0.182	4.44323
0.0965	0.355716	0.118	0	0.1395	4.08803	0.161	4.08803	0.1825	4.26563
0.097	0.177864	0.1185	0.177864	0.14	3.37749	0.1615	4.08803	0.183	4.44323
0.0975	0.177864	0.119	0.889206	0.1405	3.02216	0.162	4.08803	0.1835	4.08803
0.098	0.177864	0.1195	2.84447	0.141	2.66678	0.1625	4.08803	0.184	3.91041
0.0985	0.355716	0.12	7.28322	0.1415	2.48907	0.163	4.08803	0.1845	4.08803
0.099	0.355716	0.1205	11.715	0.142	1.60037	0.1635	3.91041	0.185	4.08803
0.0995	0.177864	0.121	15.786	0.1425	1.24481	0.164	3.73278	0.1855	3.73278
0.1	0.355716	0.1215	19.1446	0.143	0.889206	0.1645	3.73278	0.186	3.73278
0.1005	0.533557	0.122	15.2553	0.1435	0.177864	0.165	3.55514	0.1865	3.73278
0.101	0.355716	0.1225	4.08803	0.144	-0.355761	0.1655	3.37749	0.187	3.73278
0.1015	0.533557	0.123	0.889206	0.1445	-0.355761	0.166	3.37749	0.1875	3.73278
0.102	0.533557	0.1235	1.24481	0.145	-0.711566	0.1665	3.19983	0.188	3.73278
0.1025	0.711387	0.124	1.42259	0.1455	-0.711566	0.167	3.19983	0.1885	3.73278
0.103	0.711387	0.1245	1.60037	0.146	-0.711566	0.1675	3.02216	0.189	3.91041
0.1035	0.355716	0.125	1.06701	0.1465	-0.533658	0.168	2.84447	0.1895	3.91041
0.104	0.533557	0.1255	0.355716	0.147	-0.355761	0.1685	2.48907	0.19	4.08803
0.1045	0.355716	0.126	-0.711566	0.1475	-0.355761	0.169	2.66678	0.1905	4.08803
0.105	0.533557	0.1265	-5.16291	0.148	-0.177875	0.1695	2.66678	0.191	4.08803
0.1055	0.533557	0.127	-12.2996	0.1485	-0.177875	0.17	2.66678	0.1915	4.26563
0.106	0.533557	0.1275	-13.5504	0.149	-0.177875	0.1705	2.66678	0.192	4.26563
0.1065	0.533557	0.128	-4.80655	0.1495	0	0.171	2.66678	0.1925	4.79838
0.107	0.355716	0.1285	0.533557	0.15	0.355716	0.1715	2.66678	0.193	4.26563
0.1075	0.533557	0.129	-0.177875	0.1505	0.355716	0.172	2.66678	0.1935	4.79838
0.108	0.533557	0.1295	-0.889486	0.151	0.355716	0.1725	2.66678	0.194	4.62081
0.1085	0.533557	0.13	-0.177875	0.1515	0.711387	0.173	2.66678	0.1945	4.62081

Gauge41_5 Time msec	Gauge41_5 Stress MPa	Gauge41_5 Time msec	Gauge41_5 Stress MPa	Gauge41_6 Time msec	Gauge41_6 Stress MPa	Gauge41_6 Time msec	Gauge41_6 Stress MPa	Gauge41_6 Time msec	Gauge41_6 Stress MPa
0.195	4.62081	0.2165	5.33103	0.104	0.175179	0.1255	0.350347	0.147	0
0.1955	4.62081	0.217	5.1535	0.1045	0.175179	0.126	0.350347	0.1475	0.175179
0.196	4.62081	0.2175	5.1535	0.105	0.175179	0.1265	0.525503	0.148	0.175179
0.1965	4.62081	0.218	4.97595	0.1055	0.175179	0.127	0.525503	0.1485	0
0.197	4.62081	0.2185	4.97595	0.106	0.175179	0.1275	0.175179	0.149	0
0.1975	4.26563	0.219	4.97595	0.1065	0	0.128	-0.17519	0.1495	0.175179
0.198	4.26563	0.2195	4.79838	0.107	0	0.1285	0.525503	0.15	0
0.1985	4.26563	0.22	4.44323	0.1075	0.175179	0.129	0.350347	0.1505	-0.17519
0.199	4.08803	0.2205	4.44323	0.108	0.175179	0.1295	0.525503	0.151	0.350347
0.1995	4.26563	0.221	4.26563	0.1085	0	0.13	0.175179	0.1515	0.350347
0.2	3.91041	0.2215	4.26563	0.109	0.175179	0.1305	-0.17519	0.152	0.350347
0.2005	3.73278	0.222	3.91041	0.1095	0	0.131	0.525503	0.1525	0.175179
0.201	3.91041	0.2225	3.91041	0.11	0.350347	0.1315	0.175179	0.153	0.350347
0.2015	3.73278	0.223	3.91041	0.1105	0.175179	0.132	0.525503	0.1535	0.175179
0.202	3.73278	0.2235	3.73278	0.111	0.175179	0.1325	0.350347	0.154	0.175179
0.2025	3.37749	0.224	3.91041	0.1115	0	0.133	0.350347	0.1545	0.175179
0.203	3.55514	0.2245	3.91041	0.112	0.175179	0.1335	0.350347	0.155	0.175179
0.2035	3.37749	0.225	3.91041	0.1125	0.175179	0.134	0.175179	0.1555	0.350347
0.204	3.02216	0.2255	3.91041	0.113	0.175179	0.1345	0.525503	0.156	0.175179
0.2045	3.02216	0.226	3.91041	0.1135	0	0.135	0.175179	0.1565	0.350347
0.205	3.02216			0.114	0.175179	0.1355	0.175179	0.157	0.175179
0.2055	2.84447			0.1145	0.350347	0.136	0.175179	0.1575	0.350347
0.206	3.37749			0.115	0.175179	0.1365	0.175179	0.158	0.175179
0.2065	3.37749			0.1155	0.175179	0.137	0.175179	0.1585	0.350347
0.207	3.55514			0.116	0.175179	0.1375	0.175179	0.159	0.175179
0.2075	3.55514			0.1165	0.350347	0.138	0	0.1595	0.350347
0.208	3.55514			0.117	0.175179	0.1385	0	0.16	0
0.2085	4.08803			0.1175	0.350347	0.139	0.175179	0.1605	0.175179
0.209	4.26563			0.118	0.350347	0.1395	0.175179	0.161	0.175179
0.2095	4.08803			0.1185	0.175179	0.14	0.175179	0.1615	0.350347
0.21	4.26563			0.119	0.350347	0.1405	0.350347	0.162	0.350347
0.2105	4.44323			0.1195	0.175179	0.141	0.175179	0.1625	0.350347
0.211	4.44323			0.12	0.175179	0.1415	0.175179	0.163	0.175179
0.2115	4.79838			0.1205	0.350347	0.142	0.350347	0.1635	0.350347
0.212	4.97595			0.121	0.350347	0.1425	0	0.164	0.175179
0.2125	5.1535			0.1215	0.350347	0.143	0.175179	0.1645	0.350347
0.213	5.1535			0.122	0.350347	0.1435	0	0.165	0
0.2135	5.1535			0.1225	0.175179	0.144	0.175179	0.1655	0.175179
0.214	5.33103			0.123	0.350347	0.1445	0	0.166	0.175179
0.2145	5.33103			0.1235	0.175179	0.145	0.350347	0.1665	0
0.215	5.50856			0.124	0.350347	0.1455	0.350347	0.167	0
0.2155	5.50856			0.1245	0.350347	0.146	0.175179	0.1675	0.175179
0.216	5.33103			0.125	0.350347	0.1465	0.175179	0.168	0.175179
Gauge41_6 Time msec	Gauge41_6 Stress MPa	Gauge41_6 Time msec	Gauge41_6 Stress MPa	Gauge41_6 Time msec	Gauge41_6 Stress MPa	Gauge41_6 Time msec	Gauge41_6 Stress MPa	Gauge41_6 Time msec	Gauge41_6 Stress MPa
0.1685	0.175179	0.19	0	0.2115	0.525503	0.233	-0.700825	0.2545	-4.03216
0.169	0.175179	0.1905	-0.17519	0.212	-0.350391	0.2335	-0.350391	0.255	-4.2076
0.1695	0.175179	0.191	-0.17519	0.2125	-0.700825	0.234	-0.525603	0.2555	-4.38305
0.17	0.175179	0.1915	-0.350391	0.213	-1.40183	0.2345	-0.350391	0.256	-4.734
0.1705	0.175179	0.192	-0.525603	0.2135	-1.92769	0.235	-0.17519	0.2565	-4.734
0.171	0.175179	0.1925	-0.700825	0.214	-2.45366	0.2355	-0.350391	0.257	-4.90948
0.1715	0.175179	0.193	-0.876059	0.2145	-2.97973	0.236	0	0.2575	-4.55852
0.172	0.175179	0.1935	-1.57711	0.215	-3.6813	0.2365	0	0.258	-4.734
0.1725	0.175179	0.194	-2.10301	0.2155	-4.2076	0.237	0.175179	0.2585	-4.734
0.173	0.175179	0.1945	-3.1551	0.216	-4.38305	0.2375	0.175179	0.259	-4.90948
0.1735	0.175179	0.195	-4.38305	0.2165	-4.55852	0.238	0.175179	0.2595	-4.90948
0.174	0	0.1955	-5.08498	0.217	-4.734	0.2385	0.525503	0.26	-5.08498
0.1745	0.175179	0.196	-5.43601	0.2175	-4.90948	0.239	0.350347	0.2605	-5.08498
0.175	-0.17519	0.1965	-5.61154	0.218	-5.08498	0.2395	0.175179	0.261	-5.08498
0.1755	0	0.197	-5.78709	0.2185	-5.08498	0.24	0.175179	0.2615	-5.26049
0.176	0	0.1975	-6.48937	0.219	-5.08498	0.2405	0.175179	0.262	-5.43601
0.1765	0	0.198	-7.19183	0.2195	-4.90948	0.241	0	0.2625	-5.43601
0.177	0	0.1985	-7.71879	0.22	-4.734	0.2415	-0.350391	0.263	-5.43601
0.1775	0.175179	0.199	-7.36747	0.2205	-4.38305	0.242	-0.350391	0.2635	-5.78709
0.178	0	0.1995	-6.48937	0.221	-4.38305	0.2425	-0.350391	0.264	-5.61154
0.1785	0	0.2	-5.61154	0.2215	-4.2076	0.243	-0.876059	0.2645	-5.61154
0.179	0	0.2005	-4.38305	0.222	-4.2076	0.2435	-0.525603	0.265	-5.61154
0.1795	0.350347	0.201	-3.50589	0.2225	-3.85672	0.244	-0.700825	0.2655	-5.61154
0.18	0	0.2015	-2.45366	0.223	-3.6813	0.2445	-1.0513	0.266	-5.43601
0.1805	-0.17519	0.202	-1.57711	0.2235	-3.33049	0.245	-1.0513	0.2665	-5.26049
0.181	0.175179	0.2025	-0.350391	0.224	-3.1551	0.2455	-1.22656	0.267	-5.26049
0.1815	-0.17519	0.203	0.525503	0.2245	-2.80436	0.246	-1.40183	0.2675	-5.08498
0.182	0.175179	0.2035	0.875784	0.225	-2.62901	0.2465	-1.75239	0.268	-5.08498
0.1825	-0.17519	0.204	1.22602	0.2255	-2.27833	0.247	-1.75239	0.2685	-5.08498
0.183	0	0.2045	1.57621	0.226	-1.75239	0.2475	-2.10301	0.269	-4.90948
0.1835	0	0.205	2.4515	0.2265	-1.40183	0.248	-2.27833	0.2695	-4.734
0.184	0.175179	0.2055	3.15153	0.227	-1.22656	0.2485	-2.45366	0.27	-4.90948
0.1845	-0.17519	0.206	4.02632	0.2275	-0.876059	0.249	-2.62901	0.2705	-5.08498
0.185	-0.17519	0.2065	4.55106	0.228	-0.525603	0.2495	-2.97973	0.271	-5.08498
0.1855	0.175179	0.207	5.07571	0.2285	0	0.25	-2.80436	0.2715	-5.26049
0.186	0	0.2075	5.60025	0.229	-0.17519	0.2505	-3.1551	0.272	-5.26049
0.1865	0	0.208	5.77508	0.2295	-0.17519	0.251	-2.97973	0.2725	-4.90948
0.187	0.175179	0.2085	5.42541	0.23	-0.17519	0.2515	-3.50589	0.273	-4.90948
0.1875	-0.17519	0.209	4.55106	0.2305	-0.350391	0.252	-3.50589	0.2735	-4.734
0.188	0	0.2095	4.02632	0.231	-0.525603	0.2525	-3.6813	0.274	-4.734
0.1885	-0.17519	0.21	2.97654	0.2315	-0.350391	0.253	-3.6813	0.2745	-4.55852
0.189	-0.17519	0.2105	2.10142	0.232	-0.700825	0.2535	-4.2076	0.275	-4.55852
0.1895	-0.17519	0.211	1.22602	0.2325	-0.525603	0.254	-3.85672	0.2755	-4.38305

Gauge41_6 Time msec	Gauge41_6 Stress MPa	Gauge41_6 Time msec	Gauge41_6 Stress MPa	Gauge41_6 Time msec	Gauge41_6 Stress MPa	Gauge41_6 Time msec	Gauge41_6 Stress MPa	Gauge41_6 Time msec	Gauge41_6 Stress MPa
0.276	-4.55852	0.2975	-5.96264	0.319	-2.97973	0.3405	-3.33049	0.362	-0.350391
0.2765	-4.38305	0.298	-5.08498	0.3195	-3.1551	0.341	-3.33049	0.3625	-0.350391
0.277	-4.03216	0.2985	-4.03216	0.32	-2.97973	0.3415	-3.1551	0.363	-0.350391
0.2775	-4.03216	0.299	-3.85672	0.3205	-2.80436	0.342	-3.1551	0.3635	-0.350391
0.278	-4.2076	0.2995	-4.734	0.321	-2.97973	0.3425	-2.97973	0.364	-0.350391
0.2785	-3.6813	0.3	-5.61154	0.3215	-2.97973	0.343	-2.45366	0.3645	-0.350391
0.279	-4.03216	0.3005	-5.26049	0.322	-2.80436	0.3435	-2.45366	0.365	-0.350391
0.2795	-4.03216	0.301	-5.61154	0.3225	-2.97973	0.344	-2.80436	0.3655	-0.700825
0.28	-4.03216	0.3015	-5.08498	0.323	-3.1551	0.3445	-2.45366	0.366	-0.700825
0.2805	-3.85672	0.302	-3.50589	0.3235	-2.97973	0.345	-2.10301	0.3665	-0.700825
0.281	-3.85672	0.3025	-3.6813	0.324	-2.80436	0.3455	-1.57711	0.367	-0.876059
0.2815	-3.85672	0.303	-5.78709	0.3245	-2.80436	0.346	-2.62901	0.3675	-0.876059
0.282	-4.2076	0.3035	-5.08498	0.325	-2.80436	0.3465	-2.97973	0.368	-0.876059
0.2825	-4.38305	0.304	-4.90948	0.3255	-2.80436	0.347	-2.80436	0.3685	-0.876059
0.283	-4.734	0.3045	-3.50589	0.326	-2.97973	0.3475	-2.45366	0.369	-1.0513
0.2835	-4.55852	0.305	-4.734	0.3265	-2.80436	0.348	-2.27833	0.3695	-1.0513
0.284	-4.90948	0.3055	-4.2076	0.327	-2.62901	0.3485	-2.10301	0.37	-0.876059
0.2845	-4.90948	0.306	-4.03216	0.3275	-2.80436	0.349	-1.92769	0.3705	-0.700825
0.285	-4.90948	0.3065	-3.6813	0.328	-2.97973	0.3495	-1.92769	0.371	-0.700825
0.2855	-4.90948	0.307	-3.50589	0.3285	-2.97973	0.35	-1.92769	0.3715	-0.876059
0.286	-5.08498	0.3075	-4.38305	0.329	-2.97973	0.3505	-1.75239	0.372	-0.700825
0.2865	-4.90948	0.308	-4.734	0.3295	-3.1551	0.351	-1.92769	0.3725	-0.700825
0.287	-5.26049	0.3085	-4.55852	0.33	-3.50589	0.3515	-1.75239	0.373	-0.525603
0.2875	-5.08498	0.309	-4.2076	0.3305	-3.33049	0.352	-1.57711	0.3735	-0.876059
0.288	-5.08498	0.3095	-4.03216	0.331	-3.1551	0.3525	-1.40183	0.374	-0.525603
0.2885	-5.43601	0.31	-3.85672	0.3315	-3.33049	0.353	-1.40183	0.3745	-0.525603
0.289	-5.43601	0.3105	-3.85672	0.332	-3.50589	0.3535	-1.40183	0.375	-0.700825
0.2895	-5.78709	0.311	-3.6813	0.3325	-3.33049	0.354	-1.22656	0.3755	-1.0513
0.29	-5.43601	0.3115	-3.6813	0.333	-3.50589	0.3545	-1.22656	0.376	0
0.2905	-5.78709	0.312	-3.6813	0.3335	-3.50589	0.355	-1.22656	0.3765	0.350347
0.291	-5.78709	0.3125	-3.6813	0.334	-3.33049	0.3555	-1.0513	0.377	0
0.2915	-5.78709	0.313	-3.33049	0.3345	-3.33049	0.356	-0.876059	0.3775	-0.350391
0.292	-5.96264	0.3135	-3.33049	0.335	-3.50589	0.3565	-0.700825	0.378	-0.350391
0.2925	-6.13821	0.314	-3.1551	0.3355	-3.50589	0.357	-0.876059	0.3785	-0.17519
0.293	-6.66497	0.3145	-3.33049	0.336	-3.6813	0.3575	-0.350391		
0.2935	-5.96264	0.315	-3.33049	0.3365	-3.33049	0.358	-0.350391		
0.294	-5.78709	0.3155	-3.33049	0.337	-3.33049	0.3585	-0.350391		
0.2945	-5.43601	0.316	-3.1551	0.3375	-3.33049	0.359	-0.350391		
0.295	-5.78709	0.3165	-3.1551	0.338	-3.50589	0.3595	-0.525603		
0.2955	-5.78709	0.317	-2.80436	0.3385	-3.6813	0.36	-0.350391		
0.296	-3.6813	0.3175	-2.80436	0.339	-3.50589	0.3605	-0.350391		
0.2965	-3.6813	0.318	-2.80436	0.3395	-3.50589	0.361	-0.350391		
0.297	-5.26049	0.3185	-2.80436	0.34	-3.33049	0.3615	-0.350391		

# REPORT DOCUMENTATION PAGE

Form Approved  
OMB No. 0704-0188

Public reporting burden for this collection of information is estimated to average 1 hour per response, including the time for reviewing instructions, searching existing data sources, gathering and maintaining the data needed, and completing and reviewing the collection of information. Send comments regarding this burden estimate or any other aspect of this collection of information, including suggestion for reducing this burden, to Washington Headquarters Services, Directorate for Information Operations and Reports, 1215 Jefferson Davis Highway, Suite 1204, Arlington, VA 22202-4302, and to the Office of Management and Budget, Paperwork Reduction Project (0704-0188), Washington, DC 20503.

1. AGENCY USE ONLY (Leave blank)		2. REPORT DATE July 1993		3. REPORT TYPE AND DATES COVERED	
4. TITLE AND SUBTITLE Gas Gun Experiments to Determine Shock Wave Behavior in Snow: Methods and Data				5. FUNDING NUMBERS PE: 6.27.84 PR: 4A762784AT42 TA: CS WU: 012	
6. AUTHORS Jerome B. Johnson, Joseph A. Brown, Edward S. Gaffney, Daniel J. Solie, Matthew A. Sturm, and George L. Blaisdell					
7. PERFORMING ORGANIZATION NAME(S) AND ADDRESS(ES) U.S. Army Cold Regions Research and Engineering Laboratory 72 Lyme Road Hanover, New Hampshire 03755-1290				8. PERFORMING ORGANIZATION REPORT NUMBER  CRREL Report 93-11	
9. SPONSORING/MONITORING AGENCY NAME(S) AND ADDRESS(ES) Office of the Chief of Engineers Washington, D.C. 20314-1000				10. SPONSORING/MONITORING AGENCY REPORT NUMBER	
11. SUPPLEMENTARY NOTES					
12a. DISTRIBUTION/AVAILABILITY STATEMENT Approved for public release; distribution is unlimited.  Available from NTIS, Springfield, Virginia 22161				12b. DISTRIBUTION CODE	
13. ABSTRACT (Maximum 200 words)  A laboratory study of the behavior of snow under shock wave loading and unloading conditions was conducted using a 200-mm-diameter gas gun to generate loading waves in snow samples with initial densities of 100 to 520 kg m <sup>-3</sup> at temperatures of -2 to -23°C. Stress levels were 2 to 40 MPa. The response of snow to shock wave loading was measured as a function of distance from the impact plane using embedded stress gauges. Large impedance differences between snow and the stress gauges produced complex stress histories. A finite element model, along with a simple analytical model of the experiment, was used to interpret the stress histories. Snow deformation was not affected by initial temperature, but was found to be rate dependent. The initial density of the snow determined its pressure-deformation path. The pressure needed to compact snow to a specific final density increases with decreasing initial density. The release moduli increased nonlinearly from 50 MPa at a snow pressure of about 15 MPa to 2700 MPa at a snow pressure of about 40 MPa.					
14. SUBJECT TERMS Attenuation Experimental methods Porous ice Shock waves Shock wave propagation in snow Snow				15. NUMBER OF PAGES 150	
				16. PRICE CODE	
17. SECURITY CLASSIFICATION OF REPORT UNCLASSIFIED		18. SECURITY CLASSIFICATION OF THIS PAGE UNCLASSIFIED		19. SECURITY CLASSIFICATION OF ABSTRACT UNCLASSIFIED	
				20. LIMITATION OF ABSTRACT UL	