

**US-CE-C** Property of the  
United States Government  
**FIELD VERIFICATION PROGRAM**  
**(AQUATIC DISPOSAL)**

TECHNICAL REPORT D-85-7

**USE OF BIOENERGETICS TO INVESTIGATE THE  
IMPACT OF DREDGED MATERIAL ON BENTHIC  
SPECIES: A LABORATORY STUDY WITH  
POLYCHAETES AND BLACK ROCK  
HARBOR MATERIAL**

by

D. Michael Johns, Ruth Gutjahr-Gobell

Edgerton Research Laboratory  
New England Aquarium  
Boston, Massachusetts 02110

and

Paul Schauer

Environmental Research Laboratory  
US Environmental Protection Agency  
Narragansett, Rhode Island 02882

**BOOKS ARE ACCOUNTABLE PROPERTY CHARGED  
TO AN INDIVIDUAL BY NAME. PLEASE DO  
NOT LEND TO OTHERS WITHOUT CLEARING  
YOURSELF.**



September 1985  
Final Report

Approved For Public Release; Distribution Unlimited

Prepared for DEPARTMENT OF THE ARMY  
US Army Corps of Engineers  
Washington, DC 20314-1000

and US Environmental Protection Agency  
Washington, DC 20460

Monitored by Environmental Laboratory  
US Army Engineer Waterways Experiment Station  
PO Box 631, Vicksburg, Mississippi 39180-0631

TA7  
W34  
no.  
D-85-7

**REFERENCE**

Environmental  
Protection  
Agency

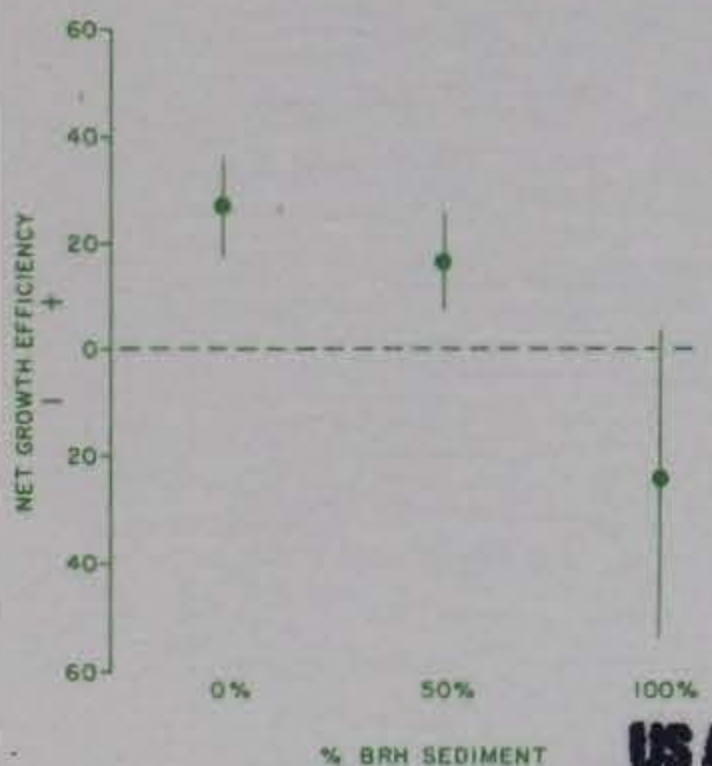

**LIBRARY BRANCH  
TECHNICAL INFORMATION CENTER  
US ARMY ENGINEER WATERWAYS EXPERIMENT STATION  
VICKSBURG, MISSISSIPPI**

**US Army Corps  
of Engineers**

SUBJECT: Transmittal of Field Verification Program Technical Report Entitled "Use of Bioenergetics to Investigate the Impact of Dredged Material on Benthic Species: A Laboratory Study with Polychaetes and Black Rock Harbor Material"

TO: All Report Recipients

1. This is one in a series of scientific reports documenting the findings of studies conducted under the Interagency Field Verification of Testing and Predictive Methodologies for Dredged Material Disposal Alternatives (referred to as the Field Verification Program or FVP). This program is a comprehensive evaluation of environmental effects of dredged material disposal under conditions of upland and aquatic disposal and wetland creation.
2. The FVP originated out of the mutual need of both the Corps of Engineers (Corps) and the Environmental Protection Agency (EPA) to continually improve the technical basis for carrying out their shared regulatory missions. The program is an expansion of studies proposed by EPA to the US Army Engineer Division, New England (NED), in support of its regulatory and dredging missions related to dredged material disposal into Long Island Sound. Discussions among the Corps' Waterways Experiment Station (WES), NED, and the EPA Environmental Research Laboratory (ERLN) in Narragansett, RI, made it clear that a dredging project at Black Rock Harbor in Bridgeport, CT, presented a unique opportunity for simultaneous evaluation of aquatic disposal, upland disposal, and wetland creation using the same dredged material. Evaluations were to be based on technology existing within the two agencies or developed during the six-year life of the program.
3. The program is generic in nature and will provide techniques and interpretive approaches applicable to evaluation of many dredging and disposal operations. Consequently, while the studies will provide detailed site-specific information on disposal of material dredged from Black Rock Harbor, they will also have great national significance for the Corps and EPA.
4. The FVP is designed to meet both Agencies' needs to document the effects of disposal under various conditions, provide verification of the predictive accuracy of evaluative techniques now in use, and provide a basis for determining the degree to which biological response is correlated with bioaccumulation of key contaminants in the species under study. The latter is an important aid in interpreting potential biological consequences of bioaccumulation. The program also meets EPA mission needs by providing an opportunity to document the application of a generic predictive hazard-assessment research strategy applicable to all wastes disposed in the aquatic environment. Therefore, the ERLN initiated exposure-assessment studies at the aquatic disposal site. The Corps-sponsored studies on environmental consequences of aquatic disposal will provide the effects assessment necessary to complement the EPA-sponsored exposure assessment, thereby allowing ERLN to develop and apply a hazard-assessment strategy. While not part of the Corps-funded FVP, the EPA exposure assessment studies will complement the Corps' work, and together the Corps and the EPA studies will satisfy the needs of both agencies.

SUBJECT: Transmittal of Field Verification Program Technical Report Entitled "Use of Bioenergetics to Investigate the Impact of Dredged Material on Benthic Species: A Laboratory Study with Polychaetes and Black Rock Harbor Material"

5. In recognition of the potential national significance, the Office, Chief of Engineers, approved and funded the studies in January 1982. The work is managed through the Environmental Laboratory's Environmental Effects of Dredging Programs at WES. Studies of the effects of upland disposal and wetland creation are being conducted by WES and studies of aquatic disposal are being carried out by the ERLN, applying techniques worked out at the laboratory for evaluating sublethal effects of contaminants on aquatic organisms. These studies are funded by the Corps while salary, support facilities, etc., are provided by EPA. The EPA funding to support the exposure-assessment studies followed in 1983; the exposure-assessment studies are managed and conducted by ERLN.

6. The Corps and EPA are pleased at the opportunity to conduct cooperative research and believe that the value in practical implementation and improvement of environmental regulations of dredged material disposal will be considerable. The studies conducted under this program are scientific in nature and will be published in the scientific literature as appropriate and in a series of Corps technical reports. The EPA will publish findings of the exposure-assessment studies in the scientific literature and in EPA report series. The FVP will provide the scientific basis upon which regulatory recommendations will be made and upon which changes in regulatory implementation, and perhaps regulations themselves, will be based. However, the documents produced by the program do not in themselves constitute regulatory guidance from either agency. Regulatory guidance will be provided under separate authority after appropriate technical and administrative assessment of the overall findings of the entire program.

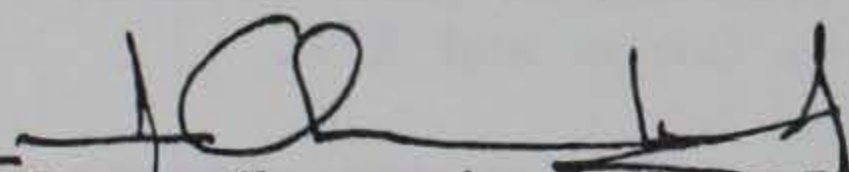
  
James Choromokos, Jr., Ph.D., P.E.  
Director, Research and Development  
U. S. Army Corps of Engineers

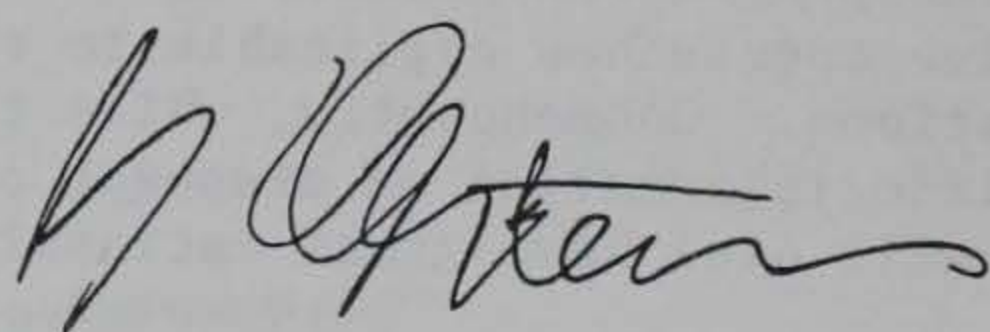
  
Bernard D. Goldstein, M.D.  
Assistant Administrator for  
Research and Development  
U. S. Environmental Protection  
Agency

Unclassified

SECURITY CLASSIFICATION OF THIS PAGE (When Data Entered)

REPORT DOCUMENTATION PAGE		READ INSTRUCTIONS BEFORE COMPLETING FORM
1. REPORT NUMBER Technical Report D-85-7	2. GOVT ACCESSION NO.	3. RECIPIENT'S CATALOG NUMBER
4. TITLE (and Subtitle) USE OF BIOENERGETICS TO INVESTIGATE THE IMPACT OF DREDGED MATERIAL ON BENTHIC SPECIES: A LABORATORY STUDY WITH POLYCHAETES AND BLACK ROCK HARBOR MATERIAL		5. TYPE OF REPORT & PERIOD COVERED Final Report
		6. PERFORMING ORG. REPORT NUMBER
7. AUTHOR(s) D. Michael Johns, Ruth Gutjahr-Gobell, Paul Schauer	8. CONTRACT OR GRANT NUMBER(s)	
9. PERFORMING ORGANIZATION NAME AND ADDRESS New England Aquarium Edgerton Research Laboratory, Central Wharf, Boston, Massachusetts 02110 and US Environmental Protection Agency, Environmental Research Laboratory, South Ferry Road, Narragansett, Rhode Island 02882		10. PROGRAM ELEMENT, PROJECT, TASK AREA & WORK UNIT NUMBERS Field Verification Program (Aquatic Disposal)
		11. CONTROLLING OFFICE NAME AND ADDRESS DEPARTMENT OF THE ARMY, US Army Corps of Engineers, Washington, DC 20314-1000 and US Environmental Protection Agency, Washington, DC 20460
14. MONITORING AGENCY NAME & ADDRESS (if different from Controlling Office) US Army Engineer Waterways Experiment Station Environmental Laboratory PO Box 631, Vicksburg, Mississippi 39180-0631		13. NUMBER OF PAGES 84
		15. SECURITY CLASS. (of this report) Unclassified
		15a. DECLASSIFICATION/DOWNGRADING SCHEDULE
16. DISTRIBUTION STATEMENT (of this Report)  Approved for public release; distribution unlimited.		
17. DISTRIBUTION STATEMENT (of the abstract entered in Block 20, if different from Report)		
18. SUPPLEMENTARY NOTES  Available from National Technical Information Service, 5285 Port Royal Road, Springfield, Virginia 22161.		
19. KEY WORDS (Continue on reverse side if necessary and identify by block number) Bioenergetics--Technique (LC)                      Marine pollution (LC) Dredging--Environmental aspects (LC)            Dredging--Connecticut--Black Rock Dredged material (WES)                              Harbor (LC) Polychaeta (LC) Benthos (LC)		
20. ABSTRACT (Continue on reverse side if necessary and identify by block number)  Both solid phase and particulate phase assays were conducted with two species of polychaetes to determine the accuracy and reproducibility of conducting bioenergetic studies on polychaetes exposed to highly contaminated dredged sediment. The two species tested were <u>Nephtys incisa</u> , an errant burrowing sediment ingestor, and <u>Neanthes arenaceodentata</u> , a tube-building surface feeder. Exposure to various treatments was for 10 days.  <p style="text-align: right;">(Continued)</p>		

20. ABSTRACT (Continued).

Results with both species of polychaetes indicate that, with few exceptions, all of the physiological parameters measured (rates of feeding, growth, reproduction, and ammonia excretion) can be made with accuracy. Changes in growth (determined as dry weight) between treatments, for example, can be measured following a 10-day exposure period providing that care is taken to adequately size the individual polychaetes prior to initiation of the experiment.

The bioenergetic endpoints measured in this study were found to be repeatable. In addition, physiological responses were found to be dose-dependent. Dosage was based on the relative proportion of reference and Black Rock Harbor sediment in a particular treatment.

This investigation is the first phase in developing field verified bioassessment evaluations for the Corps of Engineers and EPA regulatory program for dredged material disposal. This report is not suitable for regulatory purposes; however, appropriate assessment protocols that are field verified will be available at the conclusion of this program.

## PREFACE

This report describes work performed by the US Environmental Protection Agency (EPA) Environmental Research Laboratory, Narragansett, R. I. (ERLN), as part of the Interagency Field Verification of Testing and Predictive Methodologies for Dredged Material Disposal Alternatives Program (Field Verification Program (FVP)). This program is sponsored by the Office, Chief of Engineers, and assigned to the US Army Engineer Waterways Experiment Station (WES), under the purview of the Environmental Laboratory's (EL) Environmental Effects of Dredging Programs (EEDP). The OCE Technical Monitors were Drs. John Hall and William L. Klesch. The objective of this program agreement is to verify existing predictive techniques for evaluating the environmental consequences of dredged material disposal under aquatic, wetland, and upland conditions. The aquatic portion of the FVP study is being conducted by ERLN, with the wetland and upland portion done by WES.

Although not totally inclusive, we would like to thank the following researchers: Drs. John Gentile, Gerald Pesch, John Scott, Mr. William Nelson, and Ms. Carole Pesch for their many discussions and criticisms; Mr. Michael Balboni for the use of and help with their benthic exposure systems; Ms. Cornelia Mueller for supplying the N. arenaceodentata juveniles; Dr. Wayne Davis for use of the 'ant farm'; and Dr. James Heltshe for advice on statistical procedures. We would especially like to thank Dr. Anthony Calabrese and Capt. Robert Alix of the National Marine Fisheries Service in Milford, Conn., for boat time on the R/V Shang Wheeler. This research was supported by Cooperative Agreement CR809956 between the US Environmental Protection Agency and the New England Aquarium to Dr. D. Michael Johns.

The EPA Technical Director for the FVP was Dr. John H. Gentile; Technical

Coordinator was Mr. Walter Galloway; and the Project Manager was Mr. Allan Beck.

The study was conducted under the direct management of Drs. Thomas M. Dillon and Richard K. Peddicord and under the general management of Dr. C. Richard Lee, Chief, Contaminant Mobility and Criteria Group; Mr. Donald L. Robey, Chief, Ecosystem Research and Simulation Division; and Dr. John Harrison, Chief, EL. The FVP Coordinator was Mr. Robert L. Lazor, and the EEDP Managers were Mr. Charles C. Calhoun, Jr., and Dr. Robert M. Engler.

COL Tilford C. Creel, CE, and COL Robert C. Lee, CE, were Commanders and Directors of WES during the conduct of the study. COL Allen F. Grum, USA, was Director of WES during the preparation and publication of this report. Mr. Fred R. Brown and Dr. Robert W. Whalin were Technical Directors.

This report should be cited as follows:

Johns, D. M., Gutjahr-Gobell, R., and Schauer, P. 1985.  
"Use of Bioenergetics to Investigate the Impact of Dredged Material on Benthic Species: A Laboratory Study with Polychaetes and Black Rock Harbor Material," Technical Report D-85-7, prepared by US Environmental Protection Agency, Environmental Research Laboratory, Narragansett, R. I., for the US Army Engineer Waterways Experiment Station, Vicksburg, Miss.

## CONTENTS

	<u>Page</u>
PREFACE.....	1
LIST OF FIGURES.....	4
LIST OF TABLES.....	5
PART I: INTRODUCTION.....	7
Background.....	7
Purpose.....	8
Scope.....	8
PART II: MATERIALS AND METHODS.....	10
Sediment Sources and Exposure Systems.....	10
Experimental Organisms.....	17
Physiological Measurements.....	18
Burrowing Activity.....	25
Statistical Analysis.....	27
PART III: RESULTS.....	30
Sources of Variation.....	30
Treatment of Data.....	31
Consumption.....	32
Production.....	34
Maintenance Costs.....	38
Partitioning of Energy Resources.....	44
Scope for Growth.....	52
Burrowing Activity.....	54
PART IV: DISCUSSION.....	60
PART V: CONCLUSIONS.....	71
REFERENCES.....	72
APPENDIX A: SOLID PHASE AND PARTICULATE PHASE DATA SHEETS.....	A1



## LIST OF FIGURES

<u>No.</u>		<u>Page</u>
1	Central Long Island Sound disposal site and South reference site.....	11
2	Black Rock Harbor, Connecticut, source of dredged material.....	11
3	Sediment dosing system with chilled water bath and argon gas supply.....	14
4	Schematic of the suspended distribution and dosing system used to expose juvenile <u>N. incisa</u> to reference and BRH sediment.....	16
5	Schematic of respirometers (syringe and stender dish) used to determine oxygen consumption rates of <u>N. incisa</u> juveniles.....	24
6	Schematic of the narrow, glass-walled aquarium used to determine burrowing activity and maximum burrow depth.....	27
7	Net growth efficiency of <u>N. incisa</u> juveniles exposed to various mixtures of reference and BRH sediment for 10 days.....	46
8	Net growth efficiency of <u>N. incisa</u> juveniles exposed to various combinations of sediment and suspended particles for 10 days.....	48
9	Drawing of burrows created by <u>N. incisa</u> juveniles exposed to reference and BRH sediments for 10 days....	54
10	Drawing of burrows created by <u>N. incisa</u> juveniles exposed to various combinations of reference and BRH sediment for 10 days.....	56
11	Drawing of burrows created by <u>N. arenaceodentata</u> juveniles exposed to various combinations of reference and BRH sediment for 10 days.....	58

LIST OF TABLES

<u>No.</u>	<u>Page</u>
1 Sampling protocol for physiological measurements at the end of the 10-day exposure period.....	20
2 Sources of variation in respiration and ammonia excretion rate of <u>N. incisa</u> juveniles determined during initial experiments.....	31
3 Food consumption rates of <u>N. arenaceodentata</u> juveniles exposed to various sediment conditions.....	33
4 Changes in dry weight of <u>N. incisa</u> juveniles exposed to various sediment conditions.....	35
5 Changes in dry weight of <u>N. arenaceodentata</u> juveniles exposed to various sediment conditions.....	37
6 Weight-specific respiration rate of <u>N. incisa</u> juveniles exposed to various sediment conditions.....	39
7 Weight-specific respiration rate of <u>N. arenaceodentata</u> juveniles exposed to various sediment conditions.....	40
8 Weight-specific ammonia excretion rate and O:N ratios of <u>N. incisa</u> juveniles exposed to various sediment conditions.....	42
9 Weight-specific ammonia excretion rate and O:N ratios of <u>N. arenaceodentata</u> juveniles exposed to various sediment conditions.....	43
10 Cummulative energy values for production and maintenance costs of <u>N. incisa</u> juveniles.....	45
11 Net growth efficiency of <u>N. incisa</u> juveniles exposed to various sediment conditions.....	47
12 Cummulative energy values for production and maintenance costs of <u>N. arenaceodentata</u> juveniles exposed to various sediment conditions.....	50
13 Net growth efficiency of <u>N. arenaceodentata</u> juveniles exposed to various sediment conditions.....	51
14 Scope for growth values for <u>N. arenaceodentata</u> juveniles exposed to various sediments.....	53

<u>No.</u>		<u>Page</u>
15	Burrow length and maximum burrow depth of <u>N. incisa</u> juveniles exposed to various sediment conditions.....	55
16	Burrow length and maximum burrow depth of <u>N. arenaceodentata</u> juveniles exposed to various sediment conditions.....	59

USE OF BIOENERGETICS TO INVESTIGATE THE IMPACT  
OF DREDGED MATERIAL ON BENTHIC SPECIES: A LABORATORY  
STUDY WITH POLYCHAETES AND BLACK ROCK HARBOR MATERIAL

PART I: INTRODUCTION

Background

1. Effective short-term biological response measurements which can adequately detect the effects of environmental concentrations of contaminants have been called for by several international commissions (International Council for the Exploration of the Sea 1978; McIntyre and Pearce 1980). In order to be of value the measurements must have some relevance to ecological fitness. In addition, these relatively short-term laboratory effects tests (usually less than a month) must have a predictive capability which allows estimation of the degree of ecological change which will take place.

2. An effects measurement technique which may satisfy the preceding criteria is the determination of biological energy balances (Edwards 1978; Capuzzo and Lancaster 1981; Johns and Pechenik 1980; Johns and Miller 1982; McKinney 1982) along with its corollaries, including scope for growth (Warren and Davis 1967; Bayne 1975). Previous studies using these principles have found a reasonable correlation between changes in energy balances or scope for growth and changes in population fitness (Bayne et al. 1979; Gilfillan 1980). In a series of detailed field studies, for example, Gilfillan and his co-workers (Gilfillan and Hanson 1975; Gilfillan

et al. 1976; Gilfillan and Vandermeulen 1978) found a reduced scope for growth in the bivalve Mya arenaria collected from oil-impacted sites when compared to individuals from nearby, relatively clean reference populations. These data were related to and predictive of eventual changes in population structure observed in the impacted sites. Changes in population structure that Gilfillan could relate to the reduced scope for growth included reductions in yearly growth rate and population density.

#### Purpose

3. The biological effects portion of the Field Verification Program (FVP) is being implemented in two phases. The first phase is to identify biological test procedures that are responsive to highly contaminated dredged material. In this phase, the applicability, reproducibility, and repeatability of the biological measurement in the laboratory are to be demonstrated. The second phase will be to field verify the biological responses observed in the laboratory to determine the predictability of the laboratory-derived data. The purpose of this report is to describe the results of the first phase in our efforts to apply bioenergetics techniques to two species of polychaetes.

#### Scope

4. This paper describes efforts to evaluate the utility of bioenergetics techniques with the polychaetes Nephtys incisa and Neanthes arenaceodentata and to determine what effects highly

contaminated dredged Black Rock Harbor sediment have on these energy budgets. Nephtys incisa is a dominant infaunal macroinvertebrate in Long Island Sound benthic communities (Sanders 1956, 1958; Carey 1962). Impact from contaminated dredged material disposal on this species may change the present community structure. Neanthes arenaceodentata, on the other hand, is not indigenous to the Long Island Sound study area. Rather it is being tested as a possible surrogate for those infaunal polychaete species that may occur at any disposal site. In disposal sites where indigenous species may be difficult to collect, or maintain, or study in the laboratory, a surrogate species offers the opportunity to still determine potential impacts on that general group of organisms. In proposed disposal sites, where little scientific information exists on the indigenous species, the use of a suitable surrogate allows for the assessment of potential impacts without the time-consuming learning curve (i.e. methods development, etc.) that would be needed with the indigenous species.

## PART II: MATERIALS AND METHODS

### Sediment Sources and Exposure Systems

5. Reference sediment for these studies was collected from the FVP South Reference site (40°7.95"N and 72°52.7"W), which is approximately 700 m south of the southern perimeter of the Central Long Island Sound disposal site (Figure 1). Reference sediment was collected with a Smith-McIntyre grab sampler (0.1 m<sup>2</sup>) in August and December 1982 and May 1983 (collections I, II, and III, respectively). Sediment from each collection was returned to the laboratory, press sieved (wet) through a 2-mm mesh stainless steel screen, homogenized, and stored in polypropylene (collection I) or glass (collections II and III) containers at 4°C until used in experiments. Each container of material was coded with collection number, date, and jar number. (See Lake et al. 1984 for complete details.)

6. BRH sediment was collected from 25 locations within the highly industrialized Black Rock Harbor (Bridgeport, Conn.; Figure 2) study area with a 0.1-m<sup>2</sup> gravity box corer to a depth of 1.21 m. The contaminated sediment was homogenized, distributed to barrels, and stored at 4°C. The contents of each barrel were homogenized, wet sieved through a 1-mm sieve, distributed to glass jars, and stored at 4°C until used in experiments. Samples of sediment were taken at various points in the collections, mixing, and distribution procedure for moisture content and chemical analysis. (See Lake et al. 1984 for details.)

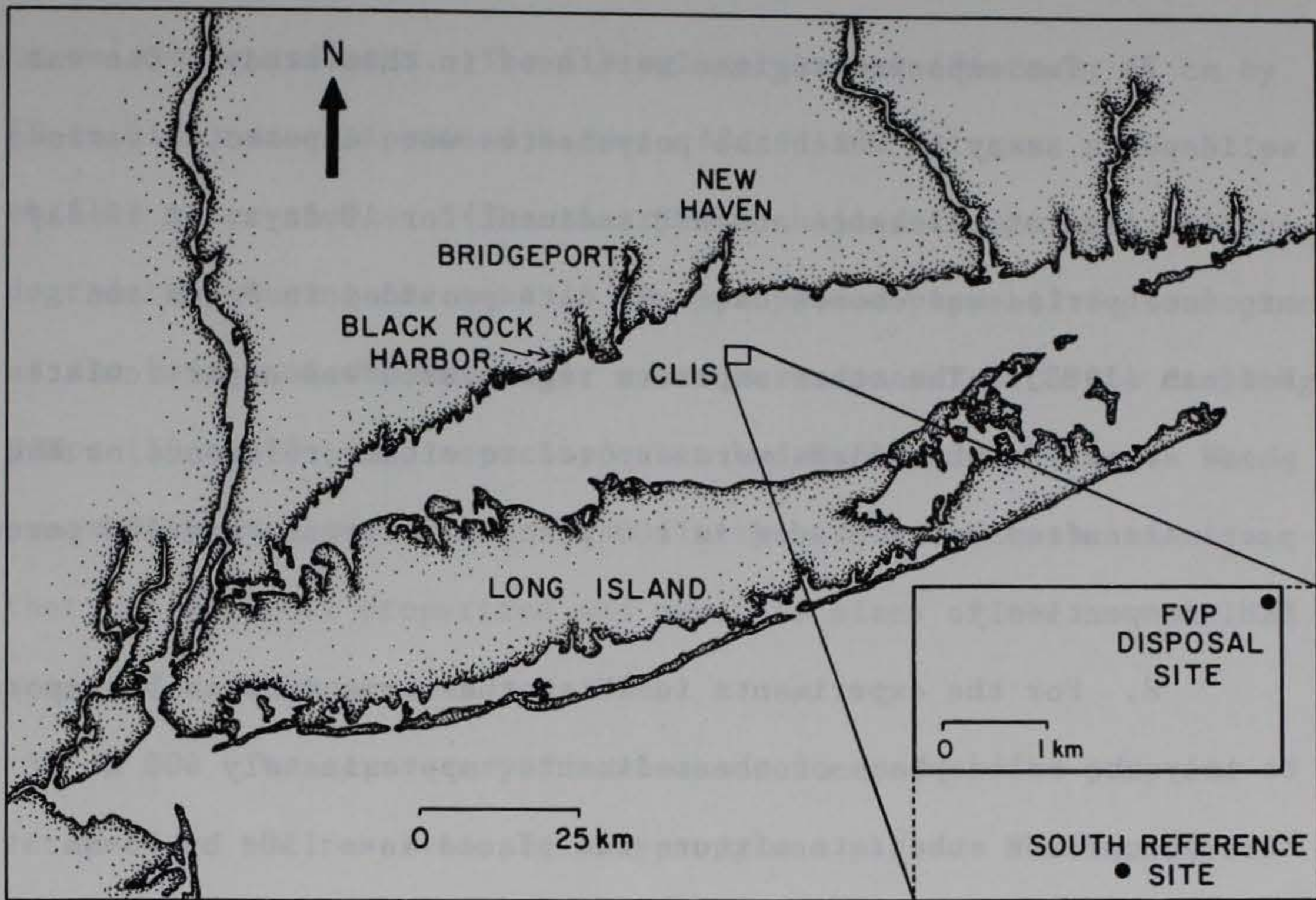

Figure 1. Central Long Island Sound disposal site and South reference site

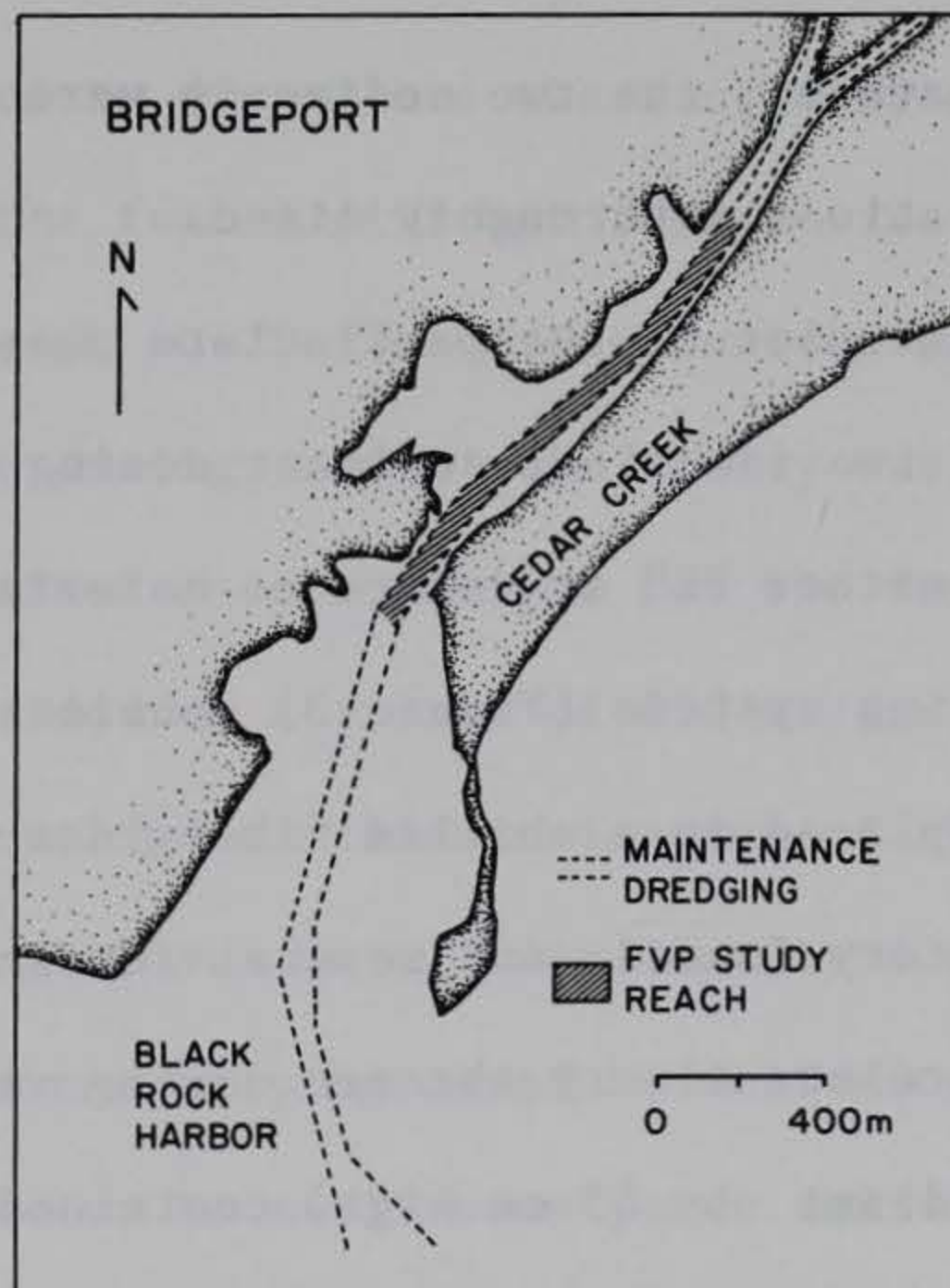

Figure 2. Black Rock Harbor, Connecticut, source of dredged material



7. Two exposure regimes were used in this study. One was a solid phase assay in which the polychaetes were exposed to various combinations of reference and BRH sediment for 10 days. A 10-day exposure period was chosen based on data provided in Pesch and Hoffman (1983). The other exposure regime used was a particulate phase assay in which worms were exposed to either reference or BRH particles after being placed in 100 percent reference and 100 percent BRH, respectively.

8. For the experiments in which the worms were to be exposed to only the solid phase of the sediments, approximately 400 ml of the appropriate substrate mixture was placed in a 150- by 75-mm dish, and then put in a water bath of 20°C (Figure 3). Seawater at 20°C was allowed to flow through the treatment bowls at a rate of approximately 50 ml/min. Where both reference and BRH sediments were used in a treatment, the two sediments were combined in a volume-to-volume ratio and thoroughly mixed.

9. Implementation of the particulate phase assays required the construction of two identical sediment dosing systems to simultaneously provide either BRH or reference material as suspended sediment. The dosing systems (Figure 3) consisted of conical-shaped slurry reservoirs placed in a chilled fiberglass chamber, a diaphragm pump, a 4- $\ell$  separatory funnel, and several return loops that directed the particulate slurry through dosing valves. The slurry reservoirs (40 cm diam. by 55 cm high) contained 40  $\ell$  of slurry composed of 37.7  $\ell$  of filtered seawater and 2.3  $\ell$  of either BRH

or reference sediment. The fiberglass chamber (94 cm by 61 cm by 79 cm high) was maintained between 4° and 10°C using an externally chilled water source. (The slurry was chilled to minimize microbial degradation during the test.) Polypropylene pipes (3.8 diam) placed at the bottom of the reservoir cones were connected to the diaphragm pumps (16 to 40  $\mu$ /min capacity) that had Teflon diaphragms. These pumps were used to circulate the slurry but minimize abrasion so that the physical properties and particle sizes of the material remained as unchanged as possible.

10. The separatory funnel was connected to the pump and returned to the reservoir by polypropylene pipes. The separatory funnel served two functions: (a) to ensure that a constant head pressure was provided by the overflow, and (b) to serve as a connection for the manifold located 4 cm below the constant head level. The manifold served to distribute the slurry by directing a portion of the flow from the funnel (through 6 mm inside diameter polypropylene tubes) through the Teflon dosing valves and back to the reservoir. At the dosing valves, the slurry was mixed with seawater to provide the desired concentrations for the toxicity tests. Argon gas was provided at the rate of 200 ml/min to the reservoir and separatory funnel to minimize oxidation of the sediment/seawater slurry. The dosing valves were controlled by a microprocessor. The microprocessor can be programmed to deliver a pulse with a duration of 0.1 sec up to continuous pulse delivery and at intervals from once every second to once every hour.

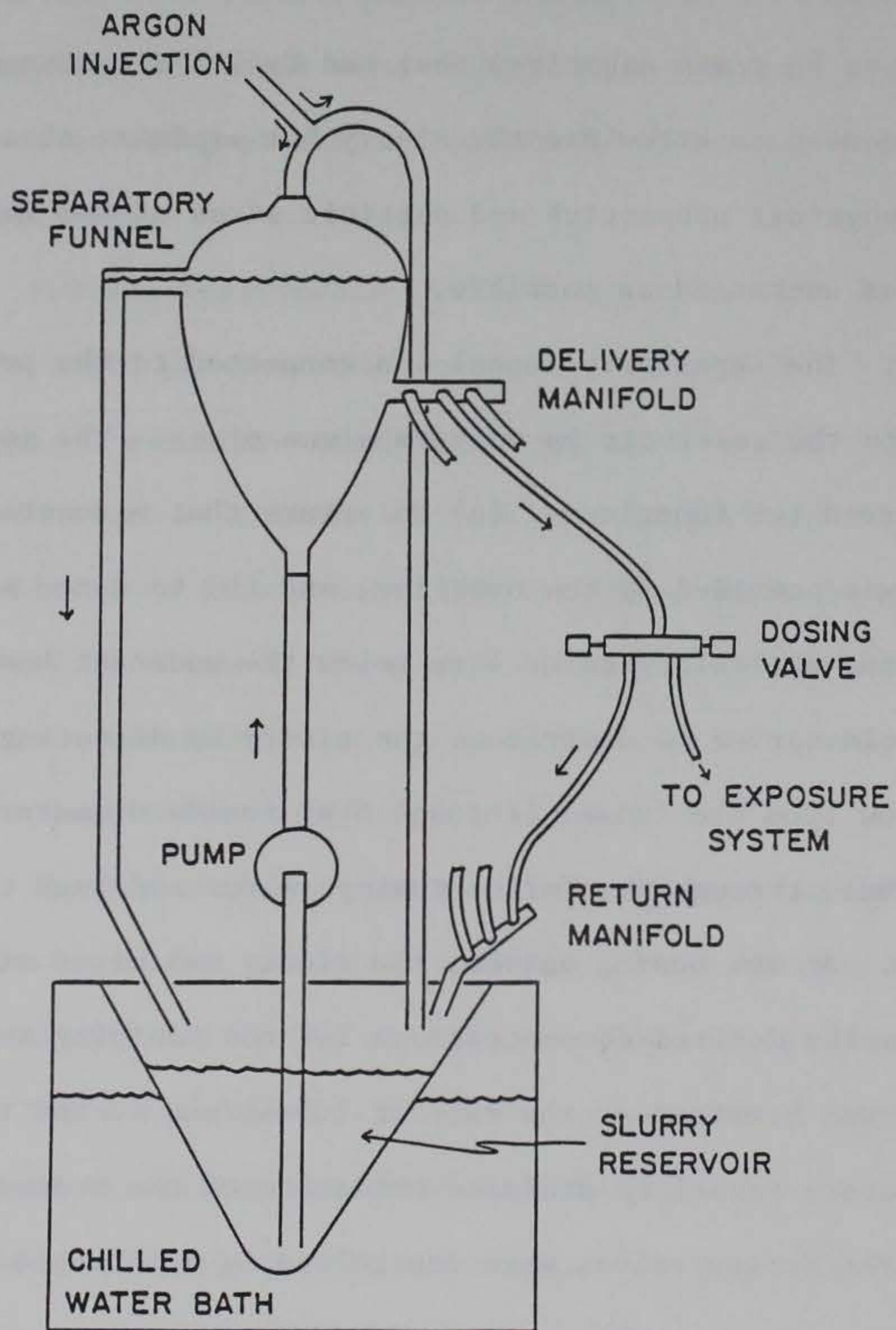

Figure 3. Sediment dosing system with chilled water bath and argon gas supply

11. Within the exposure system distribution jar, seawater at 20°C with the appropriate concentration of suspended particles was allowed to flow through the treatment bowls at a rate of approximately 35 ml/min (Figure 4). In order to maintain the particles in suspension as long as possible, a small crystallization dish with a stir bar was placed in the middle of the exposure dish. For continuity throughout this report, the scheme used to describe the particulate phase assay treatments in which there was both suspended and bedded sediments was: suspended particulate phase/solid phase.

12. In both the solid phase and particulate phase assays 15 worms of approximately the same size were placed in each treatment. After the 10-day exposure, the worms were sieved out of the mud, counted, and saved for physiological measurements.

13. During the experiment the worms were offered prawn flakes (Aquatic Diet Technology, Inc., Brooklyn, N.Y.) as a food source. Previous research\* has indicated that laboratory holdings of N. incisa grow better when offered prawn flakes than when left without. It is unclear, however, whether the prawn flakes are used directly as a food source or whether the flakes act as a substrate for bacterial growth, the bacteria then being utilized as the food source. Prawn flakes is also the food source used in maintaining laboratory populations of N. arenaceodentata (Schauer and Pesch, In Preparation). With this species, the prawn flakes are utilized directly as food.

---

\* Personal communication, Paul Schauer, July 1983, U.S. Environmental Protection Agency.

## DOSING SYSTEM

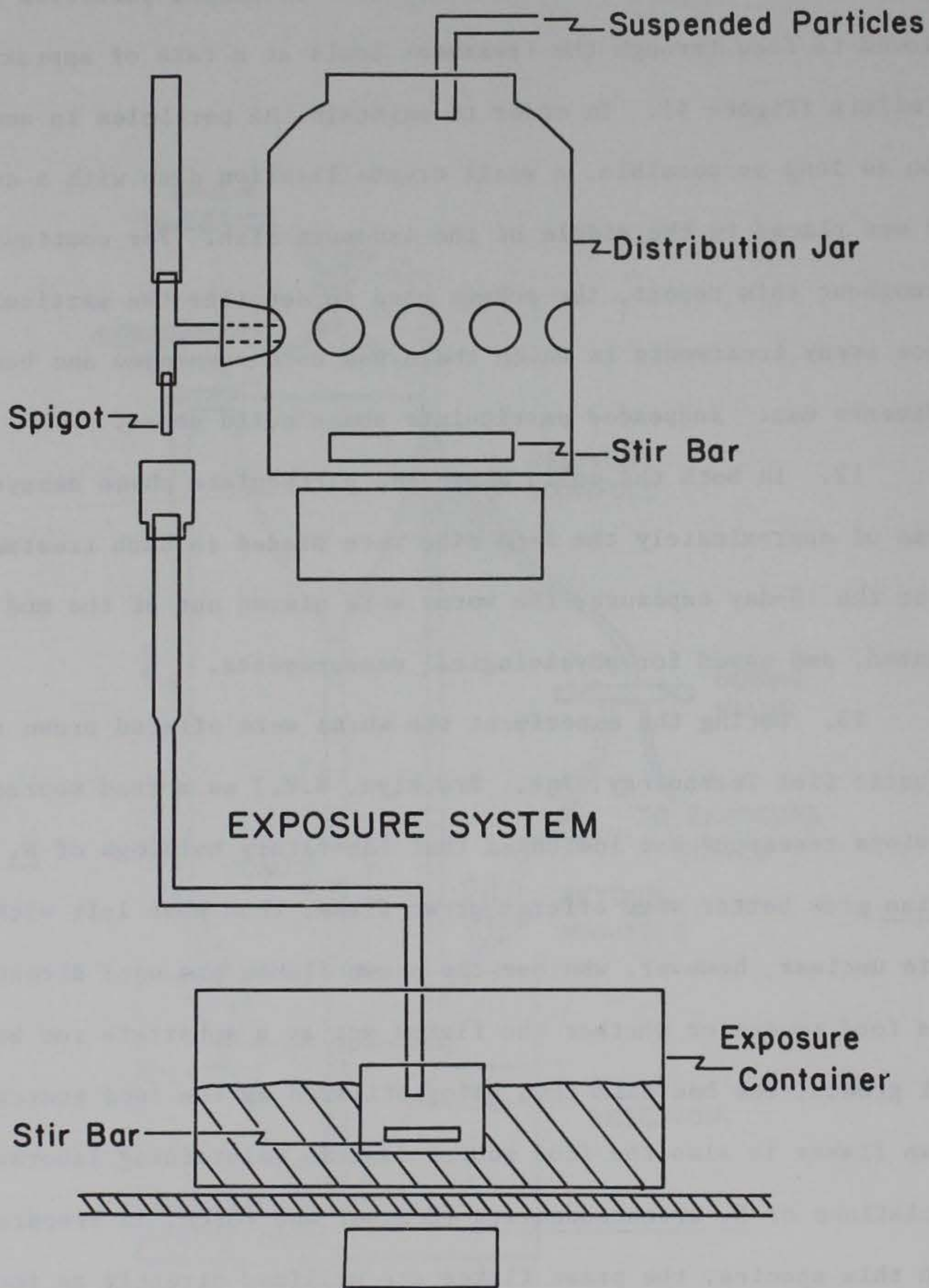

Figure 4. Schematic of the suspended distribution and dosing system used to expose juvenile *N. incisa* to reference and BRH sediment

## Experimental Organisms

14. Nephtys incisa were collected from Long Island Sound in the vicinity of the South Reference site. Bottom samples were collected using a Smith-MacIntyre grab and were initially sieved on board the research vessel. Worms which passed through a 2-mm sieve but were retained on a 0.37-mm sieve were kept for laboratory experimentation and were all juveniles (Carey 1962). The worms were then placed in a single, unsieved Smith-MacIntyre grab sample for transport back to the laboratory. In the laboratory, the worms were resieved with a 0.37-mm mesh using seawater at temperatures close to collection temperature ( $\pm 2^{\circ}\text{C}$ ).

15. Following this, individuals were visually separated into relative size classes for experiments. Although somewhat subjective, careful visual separation leads to a coefficient of variation in dry weight at the start of an experiment of only 24 percent. Other, more accurate sizing techniques, such as wet weight determinations employing a wet-weight-to-dry-weight regression curve, are time-consuming and, more importantly, may cause physical damage to the worms from the handling required.

16. All experiments were conducted at  $20^{\circ}\text{C}$ . Laboratory acclimation for Nephtys incisa collected at  $20^{\circ} \pm 3^{\circ}\text{C}$  was a minimum of 3 days to allow for adjustments to laboratory holding conditions. For worms collected at temperatures below  $16^{\circ}\text{C}$ , acclimation included a  $1^{\circ}$  to  $2^{\circ}\text{C}$  increase in temperature per day until  $20^{\circ}\text{C}$  was attained.

17. Neanthes arenaceodentata juveniles used in this study were from laboratory cultures (original stock from D.J. Reish, California State University, Long Beach, Calif.). Worms were cultured in a flow-through system at  $20^{\circ} \pm 1^{\circ}\text{C}$  and fed prawn flakes according to techniques described in Schauer and Pesch (In Preparation). Worms used in an experiment were from the same hatch and were of approximately the same age. Refer to summary data sheets in Appendix A for complete information on the ages of the worms used in each experiment.

#### Physiological Measurements

18. Although the fundamental integration of biochemical and physiological mechanisms is complex and difficult to measure, the net response can be measured at the whole organism level. Bioenergetic analysis compares the major anabolic and catabolic processes that occur and allows for an evaluation of the relative partitioning of available energy amongst growth and maintenance requirements.

19. The energy budget of the juvenile stage of an organism can be described by the following formula:

$$C = P + R + E + F \quad (1)$$

where

C = total energy consumed

P = amount of energy converted to tissue

R = amount of energy used for maintenance measured via aerobic respiration

E = amount of energy lost through ammonia excretion

F = amount of energy lost through feces

20. Scope for growth (SFG), which is a derivation of the balanced energy budget formula, is an approach which provides for an estimation of the potential for growth (Warren and Davis 1967). In this approach, the amount of energy available for growth (and reproduction in sexually mature stages) is estimated by the following relationship:

$$P = C - F - (R+E) \quad (2)$$

Since physiological measurements in SFG studies are typically made over a short period of time (< 24 hr), P in this case is an instantaneous measure of growth potential. Scope for growth is an index by which the current physiological condition of an organism can be evaluated.

21. The approach taken in this study was to attempt to (a) measure all parameters in the balanced energy budget equation to determine reliability of the measurements and ease at which the measurements can be made and (b) estimate variability in measurement so that sample size for the experiments can be determined. Following this, scope for growth values were determined where possible while at the same time actual growth was being monitored. Table 1 presents the sampling protocol and the approximate times needed to make the various physiological measurements.

22. For N. arenaceodentata, values of consumption, production, respiration, and excretion were measured directly. Therefore, scope for growth values as well as balanced energy budgets could be determined for this species. With N. incisa, however, only values



Table 1

Sampling protocol for physiological measurements at the end of  
10-day exposure period

<u>Physiological Measurement</u>	<u>Time Required hr</u>
<u>Nephtys incisa</u>	
Feeding	-
Respiration	2
Excretion	3
Total Time Required	5
<u>Neanthes arenaceodentata</u>	
Feeding	24
Respiration	4
Excretion	a*
Total Time Required	28

\* a = Respiration and excretion rates determined at same time in syringe respirometer in a time of 4 hr

of production, respiration, and excretion could be measured directly. Feeding rates, on the other hand, could not be quantitatively measured with any reliability. In failing to quantitatively estimate food consumption rates, neither scope for growth nor a balanced energy budget for N. incisa could be derived, although an estimate of the relative partitioning of energy between production and maintenance could be made. The measured parameters allowed for the calculation of a net growth efficiency using the following formula:

$$\text{Net growth Efficiency} = P/(P+R+E) \times 100\% \quad (3)$$

23. Net growth efficiency values offer insight into the degree of integration among physiological processes. It offers a time course estimate of the cumulative effects a particular condition has had on an organism. To allow for comparison to N. incisa, net growth efficiencies were also calculated for N. arenaceodentata.

#### Food consumption and assimilation efficiency

24. Food consumption rates of individual N. arenaceodentata were determined over a period of 24 hr using a preweighed amount of prawn flake as the food source. Following this period, remaining food was taken from the bowl, rinsed in deionized water, dried to a constant weight at 60°C, and weighed to the nearest 1 µg on a Perkin-Elmer AD-2Z Autobalance (Perkin-Elmer Corp., Norwalk, Conn.). Food consumption rates were taken as the difference in dry weight of the food initially offered and the amount remaining at the end

of 24 hr. In addition to collecting any remaining food particles, fecal material was also collected, rinsed, dried, and weighed.

25. The efficiency of food assimilation could then be determined as the difference in energy content between food and fecal material (energy content of fecal material - energy content of food source [J/mg] / energy content of food source [J/mg] x 100). The energy content of both the food and fecal material was determined using a wet oxidation technique in the presence of an acid-dichromate mixture (Maciolek 1962).

### Production

26. In all experiments, juvenile worms were used so that changes in dry weight reflected only changes in growth (production). At the beginning of an experiment, a subsample of individuals (10 to 15) was taken to estimate initial worm weight. The worms were quickly rinsed in deionized water, dried at 60°C for 24 hr, then weighed on a Perkin-Elmer AD-2Z Autobalance to the nearest  $\mu\text{g}$ . Following the 10-day exposure, 10 to 15 worms were taken from the experimental conditions to assess their physiological state. Individual respiration (see paragraphs 27-28) and excretion rates (see paragraph 31) were determined prior to rinsing, drying, and weighing. Table 1 presents the time course needed to make the physiological measurements for both N. incisa and N. arenaceodentata. Changes in growth were computed as being the difference in dry weight from the beginning to the end of the 10-day exposure period. After the worms were dried and weighed, energy values for the tissue

were determined using a wet oxidation technique in the presence of an acid-dichromate mixture (Maciolek 1962).

### Respiration

27. For N. incisa, routine rates of oxygen consumption were measured using a 3-cc syringe containing a small amount of surficial sediment (0.5 to 0.75 cc) as a respirometer (Figure 5). A worm was placed in each syringe with 1.5 cc of air-equilibrated seawater. After 1 hr, the oxygen concentration of 1 cc of the seawater was determined by injecting the sample onto the face of a Radiometer oxygen probe (Radiometer, Copenhagen, Denmark) fitted with a Radiometer thermostated sampling cell. The syringe was then refilled to 1.5 cc, and the new oxygen concentration recalculated. This procedure was repeated once per worm. Three control syringe respirometers containing 0.5 to 0.75 cc of sediment were included in each experiment.

28. For N. arenaceodentata, routine rates of oxygen consumption were measured using a 10-cc syringe (filled to 8 cc) containing no sediment. Rather, worms were offered 5-mm (outside diameter) glass tubes inside which they would begin to form a mucus tube. This glass tube could then be handled without any apparent effect on the worms. After 2 hr, the oxygen concentration of the seawater was determined by injecting a 1-cc sample onto the oxygen probe. With this species, the syringe was not refilled as the remaining seawater (7 cc) was used to determine ammonia excretion rates.

29. Stender dishes containing approximately 25 ml of sediment were used to test the validity of oxygen consumption rates of

N. incisa obtained from the syringe respirometers. A 35- by 50-mm stender dish with a hole drilled in the side was fitted with a Radiometer oxygen probe (Figure 5). Declining oxygen tension in the dish was monitored using a strip chart recorder. The water within the dish was stirred using a magnetic stir bar held to the top of the respirometer by a water-driven magnetic stirrer. Control runs were made with the sediment alone to determine the amount of oxygen depletion due solely to the biological oxygen demand of the sediment. The result of this test indicated that there was no significant difference in measuring respiration rate in syringes than in the larger sediment-filled stender dishes (syringe:  $1.59 \pm 0.61 \mu\text{l O}_2/\text{mg}/\text{hr}$ ; stender dish:  $1.33 \pm 0.54 \mu\text{l O}_2/\text{mg}/\text{hr}$ ). This experiment was repeated 6 times, with one stender dish respirometer and five syringe respirometers per experimental run.

## RESPIROMETERS

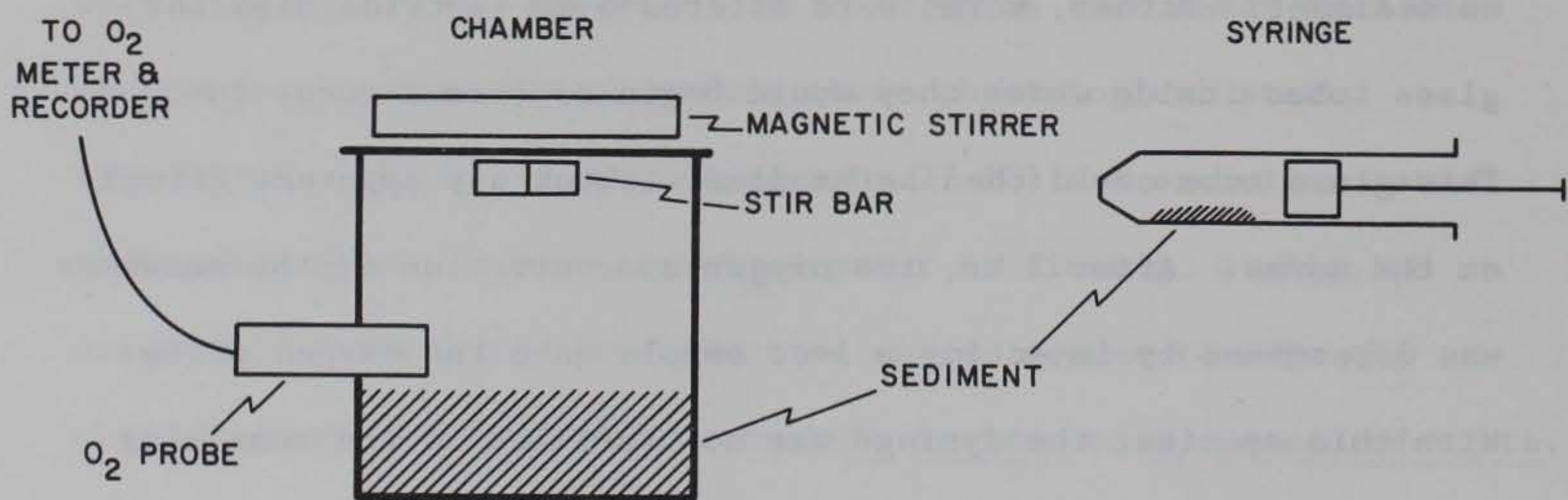

Figure 5. Schematic of respirometers (syringe and stender dish) used to determine oxygen consumption rates of N. incisa juveniles

30. In all experiments oxygen consumption rates are reported as weight-specific rates. When reported, the energy expended during routine metabolism was considered to be the average oxygen consumption rate (microliters per hour) during the experimental period times the energy equivalent for oxygen (4.80 cal/ml; Elliot and Davison 1975).

#### Excretion

31. Following their use in the respiration tests, individual N. incisa were placed in 6 ml of filtered seawater without sediment for approximately 3 hr to determine ammonia excretion rates. Following this period of time, the dry weight of each worm was taken. For N. arenaceodentata, the water for ammonia determination was taken directly from the syringe respirometers.

32. Ammonia concentrations were determined according to the technique of Bower and Holm-Hansen (1980). Calories lost per unit time as excreted ammonia were calculated by multiplying the excretion rate of an individual worm (micrograms of NH<sub>4</sub>N per hour) during the experimental period by the heat of formation of ammonia (0.62 cal/mg; Elliot and Davison 1975). Atomic ratios of oxygen consumed to ammonia excreted (O:N ratios) were calculated following the method of Corner and Cowey (1968).

#### Burrowing Activity

33. Quantitative estimates could not be made of the feeding rate for Nephtys incisa. Since this species is thought to ingest

sediment in its search for food (i.e., burrow), it was felt that making quantitative measurements on burrowing activity could provide a qualitative estimate of feeding rates. Burrowing activity of N. incisa juveniles in the solid phase assay treatments was estimated using narrow, glass-walled aquaria. The aquaria were 14 cm long by 1 cm wide and 15 cm high (Figure 6; Davis 1979). Individual aquaria were filled with homogenized mixtures of the appropriate sediment and allowed to equilibrate in a flowing seawater bath. Following this equilibration period (1 to 2 hr), two juvenile worms were randomly placed on the sediment surface. At the end of the 10-day exposure period, plastic sheets were then laid against the glass walls of the aquarium and the visible burrows traced. Total burrow lengths were calculated from these tracings using a Numonics 1224 electronic digitizer (Numonics Corp., Lansdale, N.J.). In the particulate phase assays, a tracing was made of those burrows (for both N. incisa and N. arenaceodentata) visible on the side of the exposure dish.

34. As the narrow aquaria restrict worm movements to essentially two dimensions, data collected from these aquaria do not necessarily reflect the normal patterns and depths that might be expected in the field from the sizes of worms used. They do, however, provide a relative index of the worm activity in the various treatment conditions.

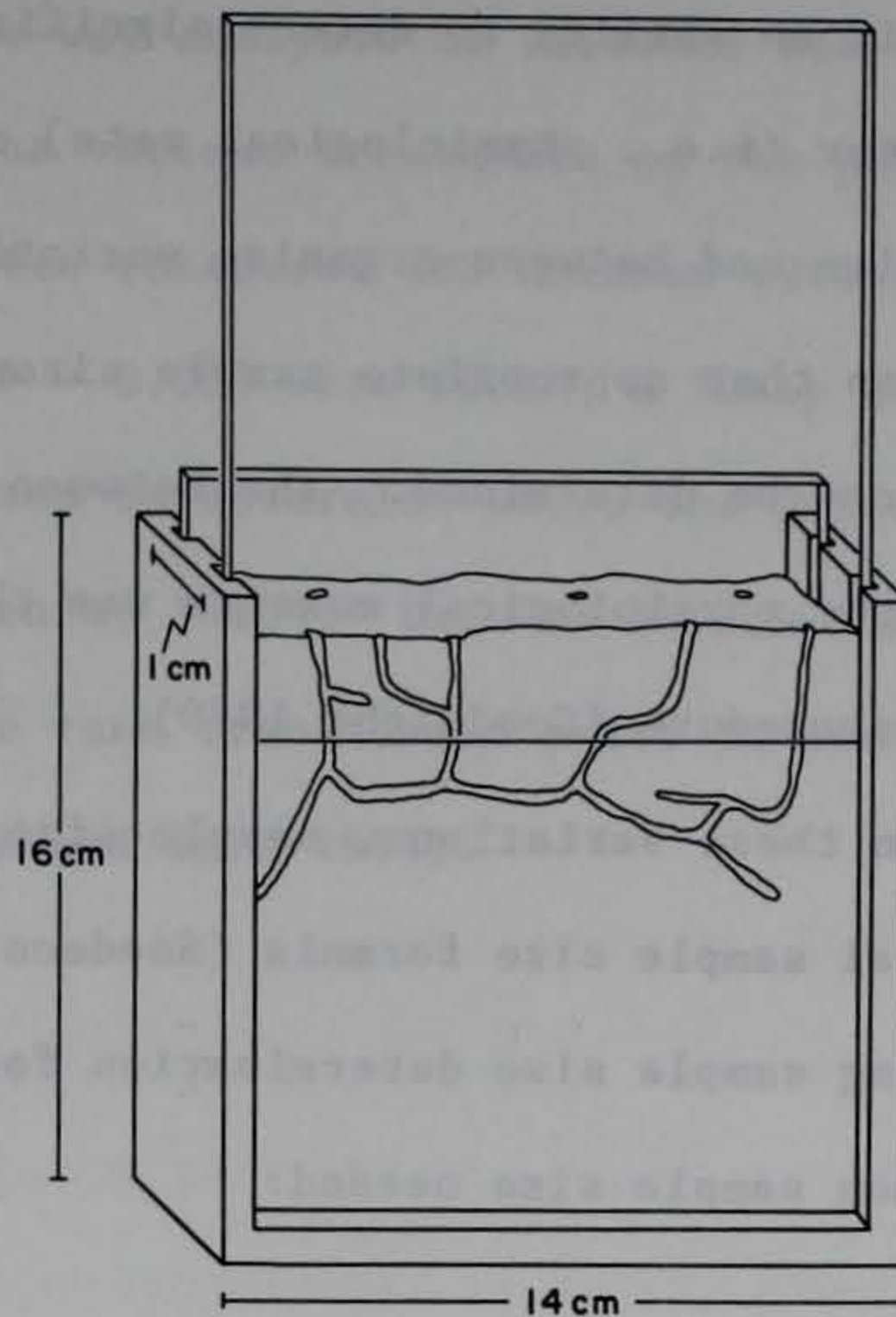

Figure 6. Schematic of the narrow, glass-walled aquarium used to determine burrowing activity and maximum burrow depth

#### Statistical Analysis

35. In order to satisfy the objectives of this study, it was important to establish the variation expected from an individual worm when making physiological measurements as well as the degree of variation expected between individuals. To establish this, repeated rate determinations (respiration or excretion rate) were made on a series of individual N. incisa.

36. Sources of variation in physiological rate measurements can include: (a) temporal changes in the rate within an organism, (b) differences in rates between organisms, and (c) the effects of a particular treatment on the physiological rate. Of prime importance



in effects studies is an ability to detect significant changes in the measured parameter (i.e., physiological rate) due to the treatment. Within-organism and between-organism variation, therefore, must be quantified so that appropriate sample sizes needed to detect a treatment effect can be determined. The between-worm and within-worm variation for the physiological measure was then determined using the VARACOMP procedure (Goodnight 1979).

37. Based on these variations, sample size was then calculated using a general sample size formula (Snedecor and Cochran 1980). The following sample size determination formula was used to determine the minimum sample size needed:

$$n = C \times (2S)/D \quad (4)$$

where

n = sample size

C = constant which is a function of a type I and type II error

S = estimate of variability from the pilot study

D = percentage deviation from the mean that is to be detected (Snedecor and Cochran 1980)

38. Where appropriate within an assay (solid phase or particulate phase), data from a particular treatment from each repeated experiment were combined for analysis. The decision to combine these data was based on the fact that within each assay there were no significant differences in worm size or respiration or excretion rates at the start of the experiment. It can therefore be concluded that there were no major physiological differences in the worms from each experiment at the beginning of the 10-day assay.

39. A one-way analysis of variance was computed to determine the effects of the various treatments on the physiological function of both polychaetes (Snedecor and Cochran 1980). If significant differences (at  $P = 0.05$ ) were found, a Tukey and Kramer pairwise comparison was used to determine where the differences existed (Snedecor and Cochran 1980). Data on burrow length and maximum burrow depth were rank transformed prior to one-way analysis of variance (Conover and Iman 1981).

## PART III: RESULTS

### Sources of Variation

#### Respiration rate

40. In this study, the greatest variance found in the respiration rates of N. incisa juveniles was the between-worm component (Table 2). Assuming that a 50 percent change in respiration rate is biologically significant and is the percent change at which treatment effects should be detectable, a sample size of 10 was found to be sufficient based on a level of confidence set at 90 percent, using the between-worm variation as the estimate of variability. If a 25 percent change in respiration rate had been chosen as the desired level, a sample size of 22 would be needed to detect significant differences.

#### Excretion rate

41. Using the approach outlined in paragraph 36, sources of variation were determined for ammonia excretion rates in N. incisa. As with respiration rates, the between-worm component was the greatest source of variation (Table 2). Because of the low variation found in the between- and within-worm variation for ammonia excretion rates, only 3 worms would be needed to detect significant differences at the 90 percent confidence level. However, ten worms were used in order to provide a complementary set of measurements to the respiration rate determinations.

Table 2

Sources of variation in respiration and ammonia excretion rate  
of *N. incisa* juveniles determined during initial experiments

	<u>Respiration Rate*</u>	<u>N**</u>	<u>Excretion Rate*</u>	<u>N**</u>
Within Worm Variance (Repeated measurements)	0.166	25	0.00000391	25
Between Worm Variance	0.340	25	0.00000624	25

\* Variance.

\*\* N= Number of Determinations.

Treatment of Data

*Nephtys incisa*

42. Within an assay, no significant differences were found in worm size and respiration and excretion rates of *N. incisa* at the start of the experiment. Therefore, data from each individual experiment (within an assay) were combined for analysis. Summary data from each individual experiment can be found in Appendix A.

*Neanthes arenaceodentata*

43. Unlike *N. incisa*, there were significant differences in worm size at the beginning of each experiment within an assay. For this reason, data from the various experiments within the particular assay were analyzed separately.

### Consumption

44. Food consumption rates of N. arenaceodentata juveniles exposed to 100-percent reference sediment for 10 days were significantly higher than those exposed to 100-percent BRH sediment (Table 3). Feeding rates of those worms exposed to the 50:50 mixture of reference and BRH sediments were not significantly different from those of the control group although they were significantly higher than those worms exposed to 100-percent BRH.

45. Juvenile N. arenaceodentata exposed in the particulate phase assays exhibited similar food ingestion patterns to those found in the solid phase assays. In experiment I, consumption rates of worms from the reference/reference (particulate phase/solid phase) and reference/BRH treatments were significantly higher than those rates for worms exposed in either the BRH/reference or BRH/BRH regimes (Table 3). In experiment II, there were significantly higher food consumption rates in juveniles from the reference/reference and BRH/reference treatments compared to those from the BRH/BRH exposure (Table 3). There was no difference, however, between reference/BRH and BRH/BRH ingestion rates as well as no significant difference between reference/BRH and both reference/reference and BRH/reference treatments (Table 3).

Table 3

Food consumption rates of *N. arenaceodentata* juveniles  
exposed to various sediment conditions

<u>Experiment</u>	<u>Treatment</u>	<u>Consumption Rates**</u> <u>mg/24 hr</u>	<u>N†</u>	<u>Gp††</u>
<u>Solid Phase Assay</u>				
I	100% REF*	4.49 ± 0.68	5	A
	50% REF/50% BRH	4.34 ± 0.72	5	A
	100% BRH	3.52 ± 0.85	5	B
<u>Particulate Phase Assay</u>				
I	REF/REF	4.49 ± 0.96	10	A
	REF/BRH	4.63 ± 1.58	10	A
	BRH/REF	3.31 ± 1.23	10	B
	BRH/BRH	3.38 ± 1.23	10	B
II	REF/REF	6.65 ± 0.92	10	A
	REF/BRH	6.35 ± 1.14	10	A,B
	BRH/REF	6.62 ± 1.36	10	A
	BRH/BRH	5.54 ± 1.00	10	B

\* Ref = Reference Sediment

\*\* Means ± S.D.

† N = Number of Determinations

†† Gp = Grouping Letter. Means having the same Gp are not significantly different at p = 0.05.

## Production

### Nephtys incisa

46. Exposure to 100-percent BRH sediment for 10 days had a significant effect on the growth of juvenile Nephtys incisa (Table 4). Worms maintained in 100-percent reference and 50-percent reference/50-percent BRH sediment conditions gained an average dry weight of 24 and 9 percent, respectively, during the 10-day exposure, while those worms in the 100-percent BRH treatment lost an average of 16 percent of their dry weight during the same period.

47. Juvenile N. incisa exposed in the particulate phase assays exhibited similar changes in dry weight (Table 4). In both experiments conducted with these conditions, worms from the reference/reference treatments (particulate phase/solid phase) were significantly heavier at the end of the 10-day exposure than those exposed to BRH/BRH. Worms from the BRH/reference treatments were not significantly different from the reference/reference worms.

Table 4

Changes in dry weight of *N. incisa* juveniles exposed to  
various sediment conditions

<u>Treatment</u>	Dry Weight**		Gp <sup>†</sup>	Change In Weight	
	<u>Initial</u> mg	<u>Final</u> mg		mg	%
<u>Solid Phase Assay</u>					
100% REF*	1.411 ± 0.246	1.743 ± 0.204	A	+0.33	+24
50% REF/50% BRH	1.411 ± 0.246	1.543 ± 0.389	A	+0.13	+9
100% BRH	1.411 ± 0.246	1.189 ± 0.105	B	-0.22	-16
<u>Particulate Phase Assay</u>					
REF/REF	3.277 ± 0.762	4.173 ± 0.535	A	+0.95	+29
REF/BRH	3.277 ± 0.762	3.742 ± 0.755	A	+0.47	+14
BRH/REF	3.277 ± 0.762	3.850 ± 0.723	A	+0.57	+18
BRH/BRH	3.277 ± 0.762	3.228 ± 0.578	B	-0.05	-2

\* Ref = Reference Sediment

\*\* Means + 1 S.D.

† Gp = Grouping letter. Means having the same Gp are not significantly different at p = 0.05



Neanthes arenaceodentata

48. Exposure to 100-percent BRH sediment did not significantly alter growth of N. arenaceodentata during the 10-day exposure period (Table 5) although the trend was for the mean dry weight of the 100-percent BRH-exposed worms to be lower than for the worms exposed in the reference sediment.

49. For experiment I of the particulate phase assay, there was no significant difference in worm dry weights at the end of a 10-day exposure to the various sediment combinations. In experiment II, however, growth of those N. arenaceodentata juveniles exposed to the BRH/BRH conditions was significantly lower than exhibited by worms from the other conditions (Table 5).

Table 5

Changes in dry weight of *N. arenaceodentata* juveniles exposed  
to various sediment conditions

Experiment	Treatment	Dry Weight**		Gp <sup>†</sup>	Change In Weight	
		Initial mg	Final mg		mg	%
<u>Solid Phase Assay</u>						
I	100% REF*	4.16 ± 1.73	6.44 ± 1.69	A	+2.28	+55
	50% REF/50% BRH	4.16 ± 1.73	5.03 ± 1.21	A	+0.87	+21
	100% BRH	4.16 ± 1.73	5.16 ± 1.08	A	+1.00	+24
<u>Particulate Phase Assay</u>						
I	REF/REF	3.52 ± 2.09	5.41 ± 1.80	A	+1.89	+54
	REF/BRH	3.52 ± 2.09	5.98 ± 1.47	A	+2.46	+70
	BRH/REF	3.52 ± 2.09	5.87 ± 1.95	A	+2.35	+67
	BRH/BRH	3.52 ± 2.09	5.35 ± 1.58	A	+1.83	+52
II	REF/REF	4.43 ± 0.92	6.51 ± 1.91	A	+2.08	+47
	REF/BRH	4.43 ± 0.92	6.27 ± 1.93	A	+1.84	+42
	BRH/REF	4.43 ± 0.92	6.26 ± 1.53	A	+1.83	+41
	BRH/BRH	4.43 ± 0.92	4.64 ± 0.88	B	+0.21	+5

\* REF = Reference Sediment.

\*\* Means ± 1 S.D.

† Gp = Grouping letter. Means having the same Gp are not significantly different at p = 0.05.

## Maintenance Costs

### Respiratory expenditures

50. Nephtys incisa. Weight-specific respiration rates of N. incisa juveniles exposed to 100-percent reference sediment were significantly higher than those of juvenile worms exposed to 100-percent BRH sediment (Table 6). Worms from the 50-percent reference/50-percent BRH treatment exhibited oxygen consumption rates intermediate to those from the 100-percent reference and 100-percent BRH conditions.

51. A similar pattern was found for those worms from the particulate phase experiments. In this assay, N. incisa juveniles from the reference/reference treatment had significantly higher respiration rates than those worms from the BRH/BRH exposure (Table 6). Respiration rates of worms from the BRH/reference treatment were also significantly higher than those of the BRH/BRH-treated worms but were not statistically different from the reference/reference individuals. Worms from the reference/BRH treatment exhibited oxygen consumption rates similar to those found in the BRH/BRH-treated worms (Table 6).

52. Neanthes arenaceodentata. No significant differences in weight-specific respiration rate were found in N. arenaceodentata exposed to the various sediment treatments (Table 7).

Table 6

Weight-specific respiration rate of *N. incisa* juveniles  
exposed to various sediment conditions

<u>Treatment</u>	<u>Respiration Rate**</u> <u><math>\mu\text{l O}_2/\text{mg/hr}</math></u>	<u>N<sup>†</sup></u>	<u>Gp<sup>††</sup></u>
<u>Solid Phase Assay</u>			
100% REF*	1.65 $\pm$ 0.77	62	A
50% REF/50% BRH	1.36 $\pm$ 0.63	56	A,B
100% BRH	1.10 $\pm$ 0.73	44	B
<u>Particulate Phase Assay</u>			
REF/REF	0.75 $\pm$ 0.20	42	A
REF/BRH	0.62 $\pm$ 0.25	42	B
BRH/REF	0.86 $\pm$ 0.25	42	A
BRH/BRH	0.66 $\pm$ 0.28	44	B

\* REF = Reference Sediment.

\*\* Means  $\pm$  1 S.D.

† N = Number of determinations.

†† Gp = Grouping Letter. Means having the same Gp are not significantly different.

Table 7

Weight-specific respiration rate of *N. arenaceodentata* juveniles  
exposed to various sediment conditions

<u>Experiment</u>	<u>Treatment</u>	<u>Respiration Rate**</u> <u><math>\mu\text{l O}_2/\text{mg/hr}</math></u>	<u>N<sup>†</sup></u>	<u>Gp<sup>††</sup></u>
<u>Solid Phase Assay</u>				
I	100% REF*	1.23 $\pm$ 0.17	4	A
	50% REF/50% BRH	1.18 $\pm$ 0.27	5	A
	100% BRH	0.94 $\pm$ 0.19	7	A
<u>Particulate Phase Assay</u>				
I	REF/REF	2.30 $\pm$ 0.61	10	A
	REF/BRH	2.23 $\pm$ 0.65	10	A
	BRH/REF	2.05 $\pm$ 0.70	10	A
	BRH/BRH	2.57 $\pm$ 0.74	10	A
II	REF/REF	1.74 $\pm$ 0.41	10	A
	REF/BRH	1.93 $\pm$ 0.50	10	A
	BRH/REF	1.81 $\pm$ 0.31	10	A
	BRH/BRH	2.16 $\pm$ 0.37	9	A

\* REF = Reference Sediment.

\*\* Means  $\pm$  1 S.D.

† N = Number of Determinations.

†† Gp = Grouping letter. Means having the same Gp are not significantly different.

Ammonia excretion rates and O:N ratios

53. Nephtys incisa. As with weight-specific respiration rates, weight-specific ammonia excretion rates of N. incisa juveniles exposed to 100-percent BRH and BRH/BRH conditions were significantly lower than those rates of worms exposed to 100-percent reference and reference/reference (Tables 8). The other treatments were intermediate between these two values.

54. No significant differences were found in O:N ratios between the various treatments in either the solid phase or the particulate phase assay (Table 8). In all cases, O:N ratios were relatively high (greater than 50) indicating that lipids and carbohydrates are being used as part of the substrate for energy production.

55. Neanthes arenaceodentata. For two of the three experiments conducted with N. arenaceodentata (solid phase experiment and experiment I, particulate phase), no significant differences in weight-specific ammonia excretion rates were found (Table 9). In the other particulate phase experiment, however, a significant increase in ammonia excretion rate was detected in those worms exposed to either the BRH/BRH or BRH/reference treatment.

56. As with N. incisa no significant differences were found in O:N ratios between the various experiments in either assay. The O:N ratios in all treatments ranged between 84 and 229 (Table 9).

Table 8

Weight-specific ammonia excretion rate and O:N ratios of *N. incisa* juveniles exposed to various sediment conditions

<u>Treatment</u>	<u>Excretion Rate**</u>			<u>O:N</u>	
	<u><math>\mu\text{g NH}_4\text{N/mg/hr}</math></u>	<u>N<sup>†</sup></u>	<u>Gp<sup>††</sup></u>	<u>Ratio**</u>	<u>Gp<sup>††</sup></u>
<u>Solid Phase Assay</u>					
100% REF*	0.011 $\pm$ 0.003	62	A	147 $\pm$ 69	A
50% REF/50% BRH	0.010 $\pm$ 0.002	56	A,B	121 $\pm$ 56	A
100% BRH	0.008 $\pm$ 0.004	44	B	98 $\pm$ 60	A
<u>Particulate Phase Assay</u>					
REF/REF	0.012 $\pm$ 0.003	42	A	67 $\pm$ 18	A
REF/BRH	0.010 $\pm$ 0.002	42	B	55 $\pm$ 22	A
BRH/REF	0.013 $\pm$ 0.004	42	A	77 $\pm$ 22	A
BRH/BRH	0.010 $\pm$ 0.004	44	B	59 $\pm$ 25	A

\* REF = Reference Sediment.

\*\* Means  $\pm$  1 S.D.

† N = Number of determinations, all three experiments combined.

†† Gp = Grouping letter. Means with the same Gp are not significantly different.

Table 9

Weight-specific ammonia excretion rate and O:N ratios of *N. arenaceodentata* juveniles exposed to various sediment conditions

<u>Experiment</u>	<u>Treatment</u>	<u>Excretion Rate**</u> <u>μg NH<sub>4</sub>N/mg/hr</u>	<u>N†</u>	<u>Gp††</u>	<u>O:N</u> <u>Ratio**</u>	<u>Gp††</u>
<u>Solid Phase Assay</u>						
I	100% REF*	0.0045 ± 0.001	4	A	110 ± 21	A
	50% REF/50% BRH	0.0034 ± 0.001	5	A	105 ± 17	A
	100% BRH	0.0050 ± 0.001	7	A	84 ± 25	A
<u>Particulate Phase Assay</u>						
I	REF/REF	0.010 ± 0.007	10	A	205 ± 55	A
	REF/BRH	0.011 ± 0.004	9	A	199 ± 58	A
	BRH/REF	0.015 ± 0.007	8	A	183 ± 62	A
	BRH/BRH	0.013 ± 0.007	7	A	229 ± 66	A
II	REF/REF	0.008 ± 0.002	9	B	155 ± 37	A
	REF/BRH	0.008 ± 0.004	10	B	172 ± 45	A
	BRH/REF	0.013 ± 0.003	10	A	161 ± 32	A
	BRH/BRH	0.014 ± 0.004	9	A	193 ± 42	A

\* REF = Reference sediment.

\*\* Means ± 1 S.D.

† N = Number of determinations.

†† Gp = Grouping letter. Means with the same Gp are not significantly different.



## Partitioning of Energy Resources

### Nephtys incisa

57. The preceding physiological data were used to calculate the efficiency at which available energy (P+R+E) was partitioned between growth and maintenance (Respiratory energy expenditure and Excretory energy losses). In both the solid phase and particulate phase experiments, maintenance costs were higher in the reference treatments (100-percent reference; reference/reference) than they were in the Black Rock Harbor treatments (100-percent BRH; BRH/BRH) (Table 10). Estimated maintenance costs for the worms from the other treatments were generally intermediate between these two extremes.

58. Energy losses through ammonia excretion were not important when compared to other energy costs involved in maintenance (i.e., respiratory expenditures; Table 10). However small, there were significant differences in energy lost when the excretion rates of worms maintained in 100-percent reference and reference/reference were compared to 100-percent BRH and BRH/BRH.

Table 10

Cummulative energy values for production and maintenance costs  
of *N. incisa* juveniles

<u>Treatment</u>	<u>Growth**</u>		<u>Respiratory Energy Expenditure**</u>		<u>Excretory Energy Loss**</u>	
	<u>J†</u>	<u>Gp††</u>	<u>J†</u>	<u>Gp††</u>	<u>J†</u>	<u>Gp††</u>
<u>Solid Phase Assay</u>						
100% REF*	4.85 ± 0.97	A	12.6 ± 3.8	A	0.035 ± 0.009	A
50% REF/50% BRH	2.01 ± 0.48	B	8.9 ± 3.6	A,B	0.029 ± 0.008	A,B
100% BRH	-2.30 ± 0.36	C	5.6 ± 2.1	B	0.020 ± 0.006	B
<u>Particulate Phase Assay</u>						
REF/REF	9.77 ± 1.86	A	14.1 ± 4.7	A	0.077 ± 0.018	A
REF/BRH	4.62 ± 0.92	B	11.2 ± 3.0	B	0.064 ± 0.018	B
BRH/REF	6.44 ± 1.42	A	15.8 ± 5.0	A	0.084 ± 0.027	A
BRH/BRH	-1.73 ± 0.52	C	9.8 ± 3.1	B	0.054 ± 0.012	B

\* REF = Reference Sediment.

\*\* Means ± 1 S.D.

† J = Joules.

†† Gp = Grouping letter. Means having the same Gp are not significantly different at p = 0.05.

59. Comparison of net growth efficiencies of N. incisa juveniles from the different treatments showed that worms maintained in 100-percent reference sediment were most efficient (+27 percent) at converting available energy to new tissue (Table 11; Figure 7). Worms maintained in 100-percent BRH were the least efficient (-24 percent) and in fact lost weight during the exposure period. In the 50-percent reference/50-percent BRH treatment, worms converted energy to tissue with an efficiency of +17 percent, which was not statistically different from the efficiency for worms maintained in the 100-percent reference condition.

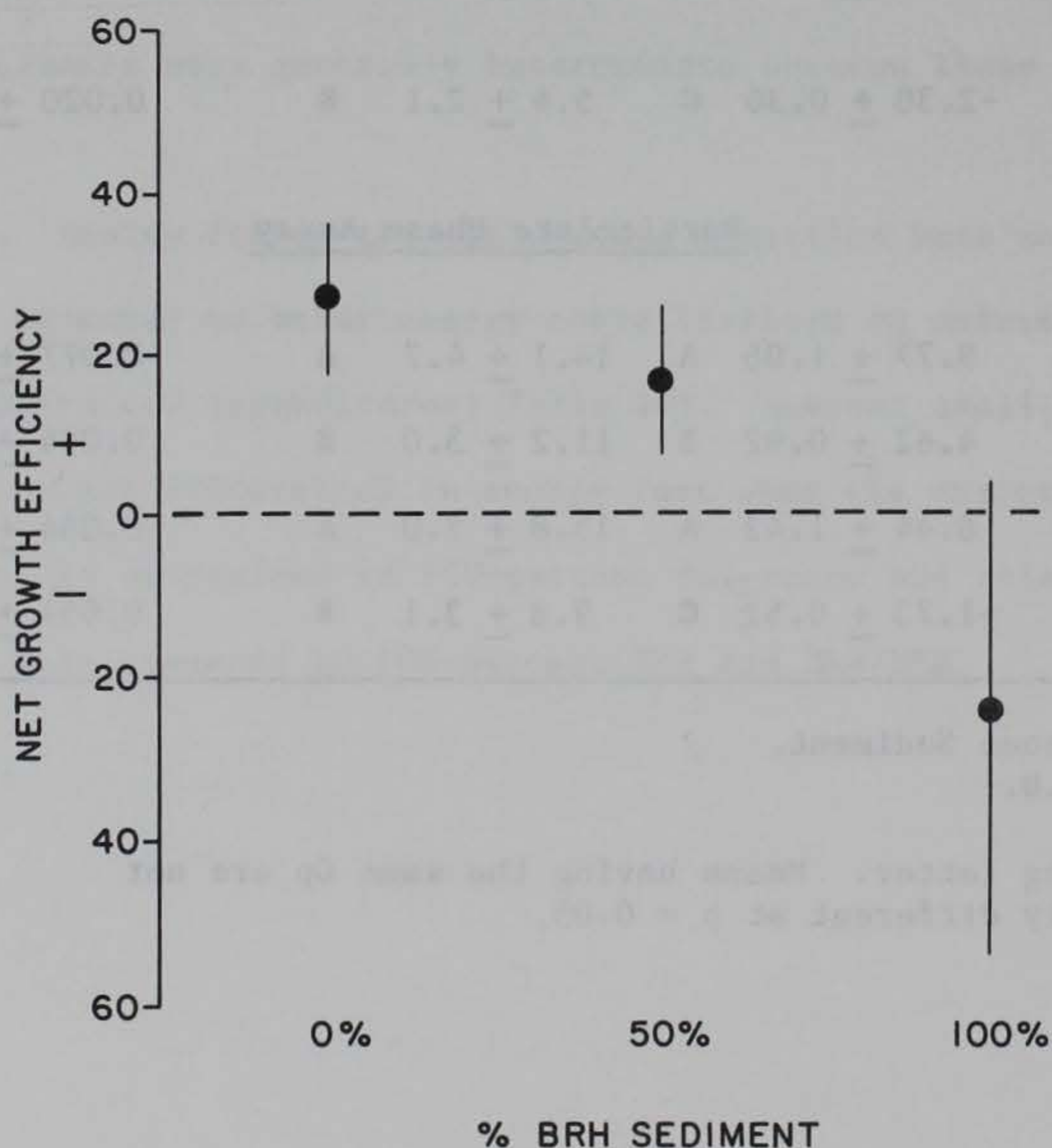

Figure 7. Net growth efficiency of N. incisa juveniles exposed to various mixtures of reference and BRH sediment for 10 days.

Table 11

Net Growth Efficiency of *N. incisa* juveniles exposed  
to various sediment conditions

<u>Treatment</u>	<u>Net Growth Efficiency**</u>	<u>Gp†</u>
<u>Solid Phase Assay</u>		
100% REF*	<u>+27</u> + 9	A
50% REF/50% BRH	<u>+17</u> + 9	A
100% BRH	-24 + <u>30</u>	B
<u>Particulate Phase Assay</u>		
REF/REF	<u>+39</u> + 10	A
REF/BRH	<u>+32</u> + 16	A
BRH/REF	<u>+27</u> + 7	A
BRH/BRH	-28 + <u>40</u>	B

\* REF = Reference Sediment.

\*\* Means + 1 S.D.

† Gp = Grouping letter. Means having the same Gp are not significantly different at  $p = 0.05$ .

60. A similar pattern of net growth efficiency was found in the particulate phase assays. N. incisa juveniles maintained under reference/reference conditions exhibited the highest net growth efficiency (+39 percent) while those in the BRH/BRH treatment had a negative net growth efficiency (-28 percent) (Table 11; Figure 8). Net growth efficiencies of worms kept in reference/BRH and BRH/reference exposures were +32 and +27 percent, respectively. These values were not significantly different from those of the worms in the reference/reference conditions.

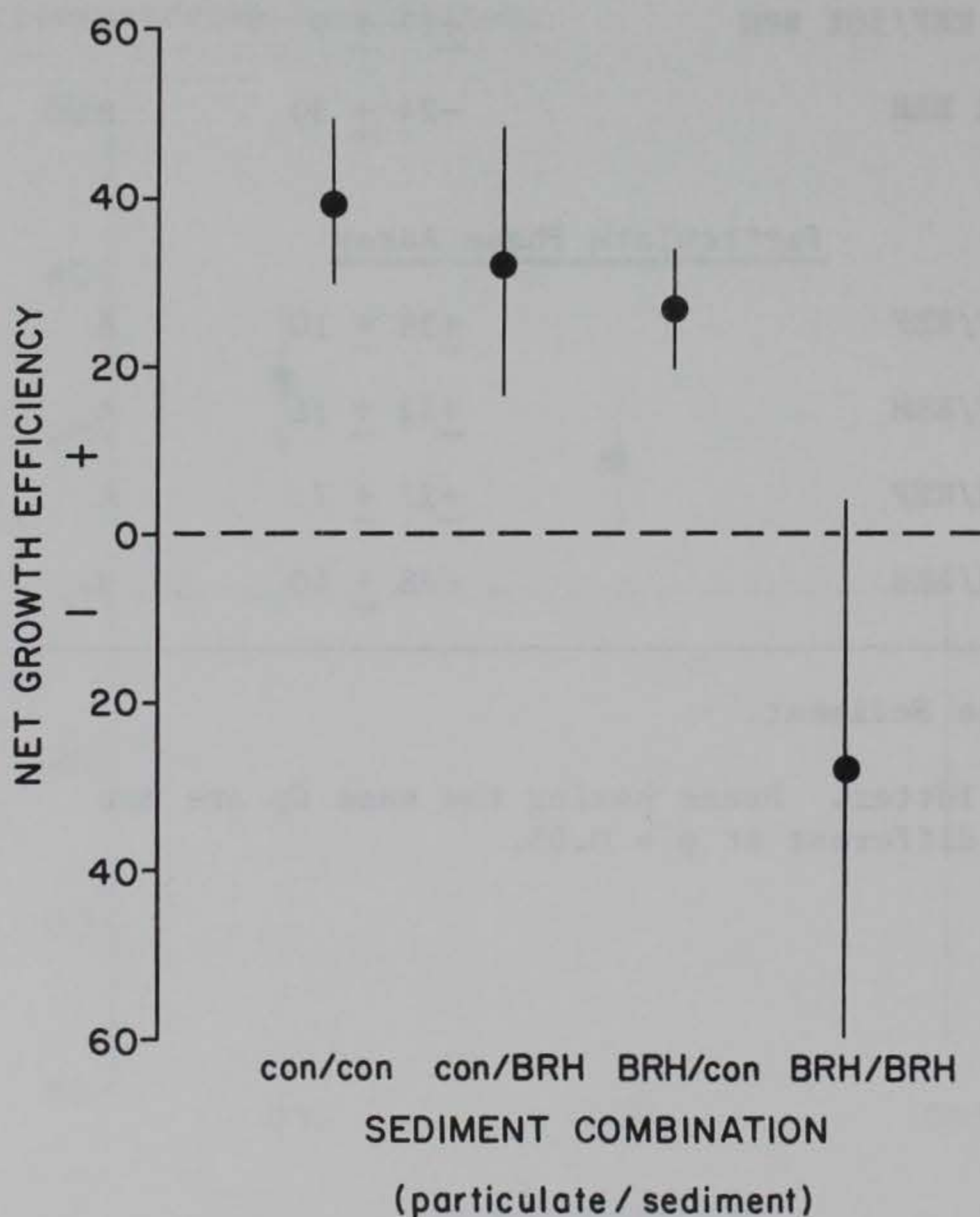

Figure 8. Net growth efficiency of N. incisa juveniles exposed to various combinations of sediment and suspended particles for 10 days

Neanthes arenaceodentata

61. The appropriate data were also used to calculate cumulative energy values and net growth efficiency for N. arenaceodentata. As can be seen in Table 12, a great amount of variance was connected with estimating tissue production during the 10-day experimental period. As with Nephtys incisa, energy losses through ammonia excretion were not important when compared to energy costs involved in other maintenance processes (respiratory energy expenditure; Table 12).

62. The large variation in production in turn leads to a large variation in calculated net growth efficiencies (Table 13). The mean net growth efficiencies of the worms maintained in the reference sediment, however, are in some agreement with those found for N. incisa. In experiment II of the particulate phase assay, the pattern of net growth efficiency is similar to that of N. incisa. In this experiment, the net growth efficiencies of worms exposed to the BRH/BRH treatment was significantly lower than it was for worms in the other treatments.

Table 12

Cummulative energy values for production and maintenance costs of N. arenaceodentata juveniles exposed to various sediment conditions

<u>Experiment</u>	<u>Treatment</u>	<u>Growth**</u>		<u>Respiratory Energy Expenditure**</u>		<u>Excretory Energy Loss**</u>	
		<u>J†</u>	<u>Gp††</u>	<u>J†</u>	<u>Gp††</u>	<u>J†</u>	<u>Gp††</u>
<u>Solid Phase Assay</u>							
I	100% REF*	22 + 20	A	38 + 9	A	0.057 + 0.016	A
	50% REF/50% BRH	14 + 19	A	30 + 11	A,B	0.028 + 0.001	B
	100% BRH	13 + 14	A	23 + 3	B	0.041 + 0.008	A
<u>Particulate Phase Assay</u>							
I	REF/REF	39 + 38	A	57 + 13	A	0.081 + 0.040	A
	REF/BRH	45 + 27	A	61 + 8	A	0.108 + 0.027	A
	BRH/REF	49 + 40	A	54 + 13	A	0.140 + 0.052	A
	BRH/BRH	37 + 32	A	62 + 7	A	0.126 + .069	A
II	REF/REF	36 + 33	A	52 + 6	A	0.080 + 0.021	A
	REF/BRH	38 + 39	A	56 + 10	A	0.083 + 0.028	A
	BRH/REF	38 + 31	A	53 + 6	A	0.140 + 0.030	A
	BRH/BRH	3 + 14	B	47 + 9	A	0.113 + 0.029	A

\* REF = Reference Sediment.

\*\* Means + 1 S.D.

† J = Joules.

†† Gp = Grouping letter. Means with the same Gp are not significantly different.

Table 13

Net growth efficiency of *N. arenaceodentata* juveniles exposed  
to various sediment conditions

<u>Experiment</u>	<u>Treatment</u>	<u>Net Growth Efficiency**</u>	<u>Gp†</u>
<u>Solid Phase Assay</u>			
I	100% REF*	+29 ± 34	A
	50% REF/50% BRH	+18 ± 42	A
	100% BRH	+27 ± 32	A
<u>Particulate Phase Assay</u>			
I	REF/REF	+30 ± 27	A
	REF/BRH	+39 ± 16	A
	BRH/REF	+41 ± 20	A
	BRH/BRH	+31 ± 23	A
II	REF/REF	+35 ± 19	A
	REF/BRH	+34 ± 24	A
	BRH/REF	+35 ± 20	A
	BRH/BRH	+ 3 ± 23	B

\* REF = Reference Sediment.

\*\* Means ± 1 S.D.

† Gp = Grouping letter. Means having the same Gp are not significantly different at  $p = 0.05$ .



### Scope for Growth

63. In order to calculate scope for growth (SFG) values, the energy content of the food offered to N. arenaceodentata had to be determined. In addition, the efficiency at which ingested food was assimilated had to be estimated. The prawn flake used as a food source in these experiments was found to have an energy value of  $18.53 \pm .471$  J/mg while the assimilation efficiency was estimated to be between 20 and 27 percent.

64. In all experiments, the SFG following a 10-day exposure to BRH sediment (100-percent BRH or BRH/BRH treatments) was significantly reduced (Table 14). The SFG values from these treatments represent a 27- to 65-percent reduction in the growth potential compared to SFG values for worms from the reference sediment conditions (100-percent reference and reference/reference).

Table 14

Scope for growth for *N. arenaceodentata* juveniles  
exposed to various sediments

<u>Experiment</u>	<u>Treatment</u>	<u>Scope for Growth**</u>	
		<u>J/Day</u>	<u>Gp†</u>
<u>Solid Phase Assay</u>			
I	100% REF*	12.1 $\pm$ 2.5	A
	50% REF/50% BRH	10.8 $\pm$ 1.4	A,B
	100% BRH	8.8 $\pm$ 2.5	B
<u>Particulate Phase Assay</u>			
II	REF/REF	7.2 $\pm$ 2.1	A
	REF/BRH	6.8 $\pm$ 3.1	A
	BRH/REF	2.6 $\pm$ 2.1	B
	BRH/BRH	2.5 $\pm$ 2.9	B
III	REF/REF	17.8 $\pm$ 3.1	A
	REF/BRH	16.8 $\pm$ 4.0	A
	BRH/REF	17.6 $\pm$ 4.2	A
	BRH/BRH	10.1 $\pm$ 2.9	B

\* REF = Reference Sediment.

\*\* Means  $\pm$  1 S.D.

† Gp = Grouping letter. Means having the same Gp are not significantly different at  $p = 0.05$ .

## Burrowing Activity

### Nephtys incisa

65. Both burrow length and maximum depth of burrowing in the 100-percent reference treatment were significantly different from similar measurements taken from the 100-percent BRH exposure (Table 15). The total length of visible burrows was approximately three times greater in the 100-percent reference condition than it was in 100-percent BRH (Figure 9). The depth to which the worms burrowed was three times greater in 100-percent reference sediment (30.4 mm) when compared to the maximum burrow depth in 100-percent BRH (9.5 mm).

#### SOUTH REFERENCE SEDIMENT

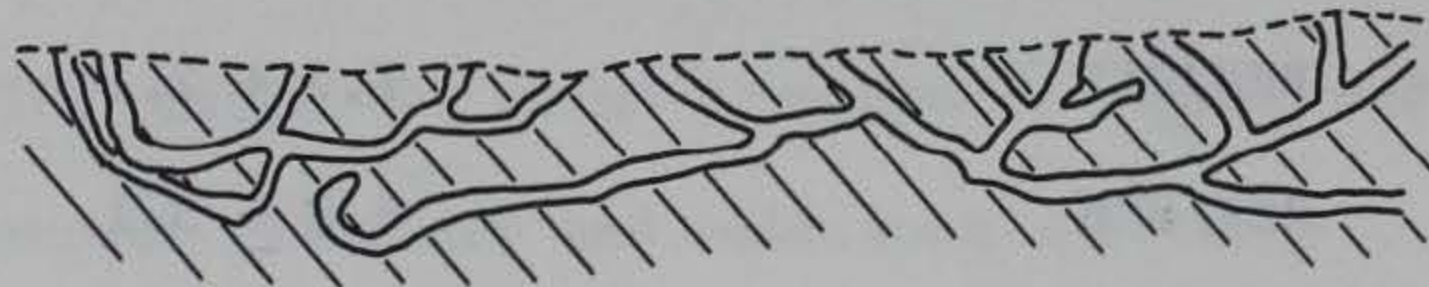

Burrow Length =  $42.2 \pm 9.9$  cm

Maximum Burrow Depth =  $30.4 \pm 7.3$  mm

---

#### BLACK ROCK HARBOR SEDIMENT

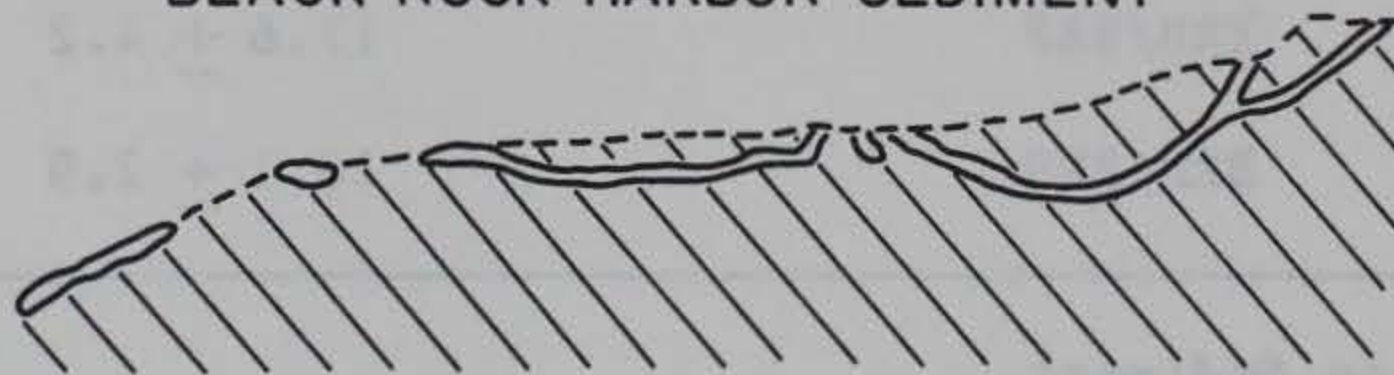

Burrow Length =  $14.2 \pm 4.7$  cm

Maximum Burrow Depth =  $9.5 \pm 2.3$  mm

Figure 9. Drawing of burrows created by N. incisa juveniles exposed to reference and BRH sediments for 10 days

Table 15

Burrow length and maximum burrow depth of *N. incisa* juveniles exposed to various sediment conditions

<u>Treatment</u>	<u>Burrow Length**</u> <u>cm</u>	<u>Gp††</u>	<u>Percent in</u> <u>Sediment</u>	<u>Maximum Burrow Depth**</u> <u>mm</u>	<u>Gp††</u>
<u>Solid Phase Assay</u>					
100% REF*	42.2 $\pm$ 9.9	A	-	30.4 $\pm$ 7.3	A
50% REF/50% BRH	N.D.†		-	N.D.	
100% BRH	14.2 $\pm$ 4.7	B	-	9.5 $\pm$ 2.3	B
<u>Particulate Phase Assay</u>					
REF/REF	43.1 $\pm$ 8.9	A	58.7	29.3 $\pm$ 2.0	A
REF/BRH	21.8 $\pm$ 1.1	B	40.8	17.0 $\pm$ 2.4	B
BRH/REF	36.9 $\pm$ 6.2	A	77.0	31.2 $\pm$ 6.1	A
BRH/BRH	9.3 $\pm$ 0.8	C	31.3	16.8 $\pm$ 2.5	B

\* REF = Reference Sediment.

\*\* Means  $\pm$  1 S.D.

† N.D. = No data.

†† Gp = Grouping letter. Means with the same Gp are not significantly different at  $p = 0.05$ .

66. Results of measurements of burrowing activity in the particulate phase experiments were similar to the preceding results, although somewhat complicated by the fact that suspended particles settled out during the course of the experiment to form a layer of sediment over the bedded sediment. Nephtys incisa from the reference/reference condition produced significantly more burrows and burrowed to a significantly greater depth than did those worms maintained in BRH/BRH (Table 15; Figure 10).

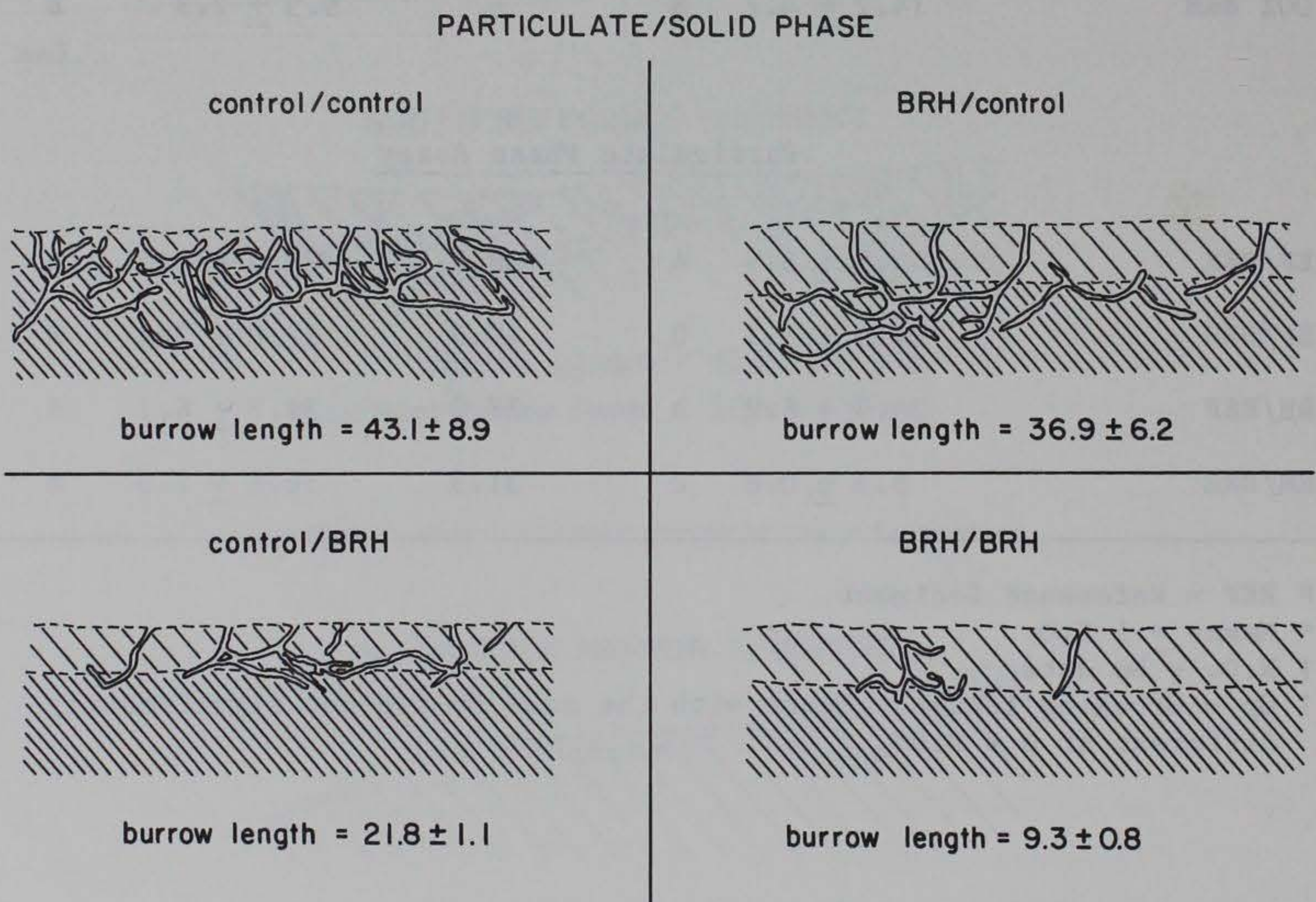

Figure 10. Drawing of burrows created by N. incisa juveniles exposed to various combinations of reference and BRH sediment for 10 days

67. Burrowing activity in the other two particulate phase treatments depended on whether the reference sediment was in the upper particulate layer or was present as the original, bedded sediment. In the BRH/reference treatment, most of the burrowing activity was concentrated in the original sediment (77 percent of activity) and the depth of burrowing was not significantly different from that found in the reference/reference treatment (Table 15; Figure 10). In the reference/BRH exposure, on the other hand, most of the burrowing activity (59 percent) was found in the particulate layer which formed during the 10-day exposure. Maximum burrow depth in this treatment was only 17 mm, which is very similar to the maximum burrow depth found in the BRH/BRH treatment.

Neanthes arenaceodentata

68. Neanthes arenaceodentata juveniles exhibited significantly greater burrowing activity (both burrow length and maximum depth of burrowing) in those treatments that had reference sediment as the bedded sediment than in those worms which had BRH as the bedded sediment (Table 16; Figure 11).

69. In all treatments, more than half of the burrowing activity occurred in the upper particulate layer which formed during the 10-day exposure, regardless of the type of sediment used in the suspended particulate phase.

PARTICULATE/SOLID PHASE

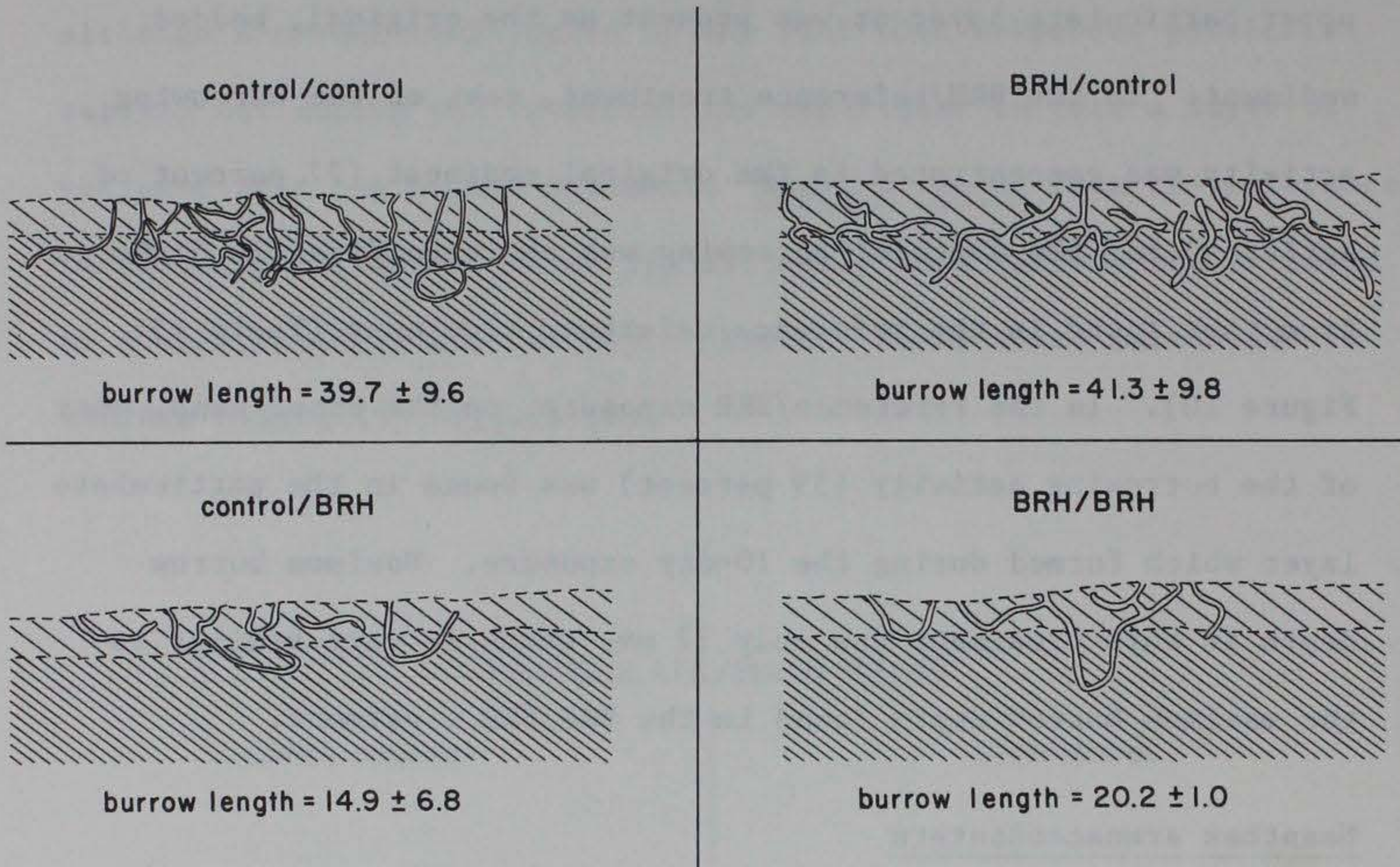

Figure 11. Drawing of burrows created by N. arenaceodentata juveniles exposed to various combinations of reference and BRH sediment for 10 days

Table 16

Burrow length and maximum burrow depth of *N. arenaceodentata*  
juveniles exposed to various sediment conditions

<u>Treatment</u>	<u>Burrow Length**</u>		<u>Percent in Sediment</u>	<u>Maximum Burrow Depth**</u>	
	<u>cm</u>	<u>Gp†</u>		<u>mm</u>	<u>Gp†</u>
<u>Particulate Phase Assay</u>					
REF/REF*	39.7 ± 9.6	A	49	26.8 ± 11.3	A
REF/BRH	14.9 ± 6.8	B	24	17.0 ± 4.1	B
BRH/REF	41.3 ± 9.8	A	32	34.2 ± 4.0	A
BRH/BRH	20.2 ± 1.0	B	37	17.0 ± 9.2	B

\* REF = Reference Sediment.

\*\* Means + 1 S.D.

† Gp = Grouping letter. Means having the same Gp letter are not significantly different at  $p = 0.05$ .



#### PART IV: DISCUSSION

70. Nephtys incisa is a nonselective deposit feeder and is typically found in soft sediments. It does not build permanent tubes, but rather burrows indiscriminately, ingesting sediment and associated microorganisms as a food source (Davis 1979). This species is considered a member of the equilibrium assemblage in Long Island Sound (Rhoads and Germano 1982), and is usually associated with sediments that are oxygenated to depths of up to 10 cm. The physical effects of the errant burrowing behavior of N. incisa on local sediments are the provision of vertical particle mixing and the enhancement of pore water exchange (Rhoads and Germano 1982). Much of the burrowing activity occurs at the redox boundary, a zone typically high in microorganism productivity (Yingst and Rhoads 1980).

71. The data presented here for the reference sediment treatments indicate that N. incisa juveniles perform much the same organism-sediment roles as do the adult stages. Burrowing activity during the 10-day experimental period was extensive, with burrows penetrating up to 30 mm in depth. Respiratory pumping also appeared to be effective in pore water exchange, as the burrow tubes had an observable 'halo' of light sediment which is an indicator of oxidized sediment (Aller and Yingst 1978).

72. The physiological measurements determined with Nephtys incisa juveniles were reproducible and repeatable. (Review Appendix A for data from each individual experiment.) Within an experiment,

each response measured (growth, respiration and ammonia excretion rate, and burrowing activity) exhibited standard deviations about the mean value that were less than 28 percent. This is an indication that the response measurements are reproducible, providing the measurement technique is followed properly. To adequately measure growth, for example, care must be taken at the beginning of the experiment to size the worms. Failure to control the variance in initial dry weight will reduce the chances (statistical) of being able to detect growth differences among the various treatments at the end of a 10-day experiment.

73. Almost all of the biological endpoints evaluated with Nephtys incisa followed a dose-response to additions of BRH sediment. These responses were repeatable from one experiment to another. The only exception to this was the calculated O:N ratios which did not exhibit a response across the treatments used.

74. Net growth efficiencies for N. incisa juveniles maintained in control sediments are within the range of efficiencies reported for polychaetes under a variety of conditions. For instance, Carey (1962) estimated population production and respiration values for N. incisa from a Long Island Sound study site. Using data from his Table 9, a mean net growth efficiency of 36 percent is calculated (population production/population production + respiration). Net growth efficiency for omnivorous polychaetes (both indiscriminate sediment ingesters, as well as surface detrital feeders) has been found to be generally between 14 and 40 percent (Kay and Brafield 1973; Tenore and Gopalan 1974; Neuhoff 1979).

75. The effects of exposure to BRH sediment are twofold. First, N. incisa juveniles greatly reduce their burrowing activity when exposed to whole BRH sediment. This was graphically demonstrated in Figures 9 and 10, where worms maintained in BRH sediment for 10 days demonstrated almost no burrowing activity and no depth penetration. Similar results were found in the lugworm, Arenicola cristata, exposed to kepone-contaminated sediments (Rubinstein 1979).

76. In the suspended particulate assays, where a choice between sediments was offered as settling of the particulate dose occurred, N. incisa appeared to avoid BRH sediment. Comparison of the reference/BRH treatment to the BRH/reference treatment illustrates this point. Almost all of the burrowing activity in the reference/BRH treatment was in the upper settled layer. This activity occurred only after the sediment layer was formed. Worms from the BRH/reference exposure exhibited an opposite activity level. In this treatment, there was extensive reworking of the lower, reference sediment, while there was very little activity in the upper, sedimented BRH material. The only burrows present in this upper layer were a few, fairly vertical ones to the surface (when compared to reference/reference and reference/BRH). These burrows probably provide the worms with a supply of oxygenated water to meet their respiratory requirements.

77. The dramatic decrease in burrowing activity of N. incisa juveniles that occurred during exposure to BRH indicates that the worms are probably curtailing physiological functions. If the primary energy source of this species is ingested sediment, then

curtailing burrowing activity has the effect of starving the individual. This is, in essence, the second effect BRH sediment has on the species. This effect is brought about by the failure of the worms to consume a sufficient amount of energy for normal physiological and biochemical processes. Nephtys incisa exposed to BRH sediments generally exhibited lowered maintenance costs, most probably in response to the reduced energy intake and reduced burrowing activity. Despite these lowered costs, individuals in the BRH sediment had to catabolize some tissue in order to provide the energy requirements of routine metabolism. Catabolism of tissue to meet energy requirements is a common phenomenon in organisms that are below their required maintenance ration (Pandian 1975).

78. In those treatments where there was a choice between BRH and reference sediments, however, there was an increase in burrowing activity (with a majority of the activity occurring in the reference sediment; Fig. 10). The increase in activity noted in the BRH/reference and reference/BRH sediments is apparently sufficient to provide enough energy for both maintenance costs and growth. Worms under these sediment conditions had lower, but not significantly different, net growth efficiencies than did worms maintained in the reference sediment (Table 11).

79. In contrast to N. incisa, N. arenaceodentata is primarily a surficial deposit feeder that builds somewhat permanent mucus tubes near the sediment surface. Unlike N. incisa, N. arenaceodentata will leave their tubes to search the sediment surface for food. Despite these differences in feeding habits, N. arenaceodentata

juveniles exhibited burrowing patterns similar to those of N. incisa. Burrowing activity was reduced in particulate phase assays in which BRH sediment was the bedded sediment. In addition, depth of burrowing was also shallower in those treatments where BRH sediment existed as the bedded sediment.

80. The physiological responses of N. arenaceodentata to exposure to BRH sediment, however, were not as dramatic as they were with N. incisa. In only one of the three experiments conducted with N. arenaceodentata was there a significant difference in dry weight at the end of the 10-day exposure. In addition, no significant differences in respiration rates were found in any of the various experiments. Food consumption rates, however, were found to be affected, with lower rates found in those worms exposed to BRH sediment. The general lack of physiological response by N. arenaceodentata to BRH sediment may have been due to several factors.

81. One is simply that exposure to BRH sediment does not cause any change in the growth rate or physiological rate of this species. Unlike N. incisa, which appears to curtail burrow/feeding activity in BRH sediment, N. arenaceodentata feeds on detrital material found on the sediment surface and thus can avoid ingesting BRH sediment under some conditions. The conclusion that BRH sediment does not have a physiological effect on N. arenaceodentata, however, is not probable since food consumption rates were affected by exposure to BRH sediment.

82. It is also possible that the mucus tube formed by this species may reduce its contact with surrounding sediments. This,

in turn, would reduce its exposure to contaminants that are found in BRH sediment. Although not specifically tested for in this study, it would be interesting to determine what degree of protection from sediment contaminants is offered by mucus tubes.

83. Another explanation, however, for the lack of any measurable growth response to BRH sediment is that the variance in worm sizes at the beginning of an experiment was so great that any changes in growth rate resulting from the treatment exposure could not be detected after the 10-day exposure period. With N. incisa the coefficient of variation in dry weight at the beginning of an experiment was 24 percent, while with N. arenaceodentata the coefficient of variation in worm size was quite large in the first two experiments (42 and 59 percent, respectively). This degree of variation made it difficult at best to measure growth in as short a time period (10 days) as used in this study. In the third experiment (particulate phase, experiment III), on the other hand, where significantly lowered growth was detected in those worms from the BRH/BRH condition, the coefficient of variation for dry weight at the start of the experiment was only 21 percent. While it is not known whether the relationship between low variation in worm size at the beginning of an experiment and the ability to detect changes in growth after 10 days is causal or casual, more time will be spent in future experiments with N. arenaceodentata in selecting worms for experimentation.

84. The net growth efficiencies calculated in this study for N. arenaceodentata were within the range of values reported in the literature for detrital feeding polychaetes (Kay and Brafield 1973;

Neuhoff 1979). The large variation found about the mean net growth efficiency in all of these experiments was probably largely due to poor control in worm size at the beginning of the experiments. It is interesting to note that the net growth efficiencies of both N. arenaceodentata and N. incisa in reference sediment conditions were similar.

85. Insight into differences in mode of exposure that may exist for these two species can be seen by examining the net growth efficiencies from the BRH exposures. For N. incisa, exposure to BRH sediment greatly reduced burrowing activity which directly affected the amount of energy (food) ingested. The impact of this is apparent in the negative net growth efficiency for N. incisa from the BRH treatments.

86. Although burrowing activity is reduced in BRH sediment with N. arenaceodentata, this fact does not necessarily lead to reduced energy injection rates as with N. incisa. Since N. arenaceodentata is a surficial detrital feeder, rates of food ingestion are probably not related to burrowing activity, at least not as strongly as it does with sediment injectors such as N. incisa. Net growth efficiency for N. arenaceodentata in BRH/BRH treatment (experiment II, particulate phase assay) was lower than for those individuals in the reference/reference condition, but the efficiency remained positive, suggesting that feeding did continue in BRH sediment although at some reduced level.

87. Unlike net growth efficiency which is an integrative measure of past physiological condition (i.e., a measure of the

efficiency at which an organism grew during the experimental period), scope for growth is an index by which the current physiological condition of an organism is evaluated (i.e., is a measure of the potential for growth). It does not provide a time course estimate of the cumulative effects a particular condition has had on an organism as does net growth efficiency. Rather, SFG evaluates current physiological condition--the current physiological state obviously being a product of those conditions to which the organism was exposed to in the recent past. Combined, these two estimators of organismal health (net growth efficiency and SFG) offer insights into what the effects of a particular set of conditions have been.

88. In the present study, the SFG values indicate that BRH sediment (100-percent BRH, BRH/BRH treatments) reduces the amount of energy available for growth in N. arenaceodentata juveniles (Table 14). This is particularly interesting in light of the fact that the net growth efficiency values for two of the experiments did not indicate any effect of BRH sediment on the growth of this species. SFG values of N. arenaceodentata followed a dose-reponse to additions of BRH sediment in all experiments, while net growth efficiency did not. The reason for this is that SFG values are not as sensitive to differences in size as is the measure of net growth efficiency. Changes in size over the experimental period are not taken into account in SFG determinations whereas these changes in growth are an important factor in calculating net growth efficiency.



89. The SFG values presented in this study are probably an overestimate of what may be the actual energy available for growth. The SFG estimates for worms from the reference sediment exposure are at least twice as high as the amount of growth that was recorded during the 10-day experimental period. This was determined by multiplying the mean SFG value (which is calculated for a 24-hr period) by the length of the experiment (Table 14) and comparing this to the average energy equivalent for the amount of tissue produced during the 10-day exposure (Table 12). This is not an entirely correct procedure for comparing actual growth with data which allows for the prediction of growth (in this case, SFG) and is probably partly responsible for the overestimation of the growth potential in this particular case. Scope for growth determinations should instead be made at several times during the experimental period in which growth will actually be measured to better track potential for growth. By determining SFG only at the end of the experimental period, all estimates for the potential for growth are for individuals larger than existed during most of the experiment. As the potential for growth probably increases with size (at least within the juvenile stage), SFG values from worms at the end of the 10-day experimental period should be greater than those from worms from the beginning of the experiment and would thus tend to overestimate previous potential for growth.

90. Another reason to believe that the SFG values presented here are an overestimate of growth potential is the fact that no attempt was made to calculate the amount of energy loss associated

with mucus production. As noted earlier, N. arenaceodentata builds tubes of mucus and sediment and these tubes appear to be continually rebuilt. (Personal observation of the Neanthes cultures suggest that mucus production is virtually constant.) As mucopolysaccharides are high in energy content, the production of these compounds would be at a considerable cost in terms of energy. For example, it is estimated that approximately 30 percent of assimilated energy is partitioned as the cost of mucus production in some invertebrate species which produce copious quantities of mucus (Pandian 1975). Future bioenergetics research with this species will take into account the amount of assimilated energy that is used in mucus production.

91. The effects of BRH sediment are probably due to at least one of two factors. Either the worms (especially N. incisa) were responding to a difference in particle size, or they were reacting to contaminants within the BRH sediment. While the first possibility cannot be completely discounted, Carey (1962) found no correlation between the occurrence of N. incisa populations in Long Island Sound and particle-size distribution despite significant differences in the granulometry among the various sites.

92. The second possibility appears to be the most likely factor affecting N. incisa. Black Rock Harbor sediment is a multi-contaminated sediment that contains a wide variety of anthropogenic chemicals. Qualitative analysis of BRH sediments indicates the presence of high concentrations of polychlorinated biphenyls, polynuclear aromatic hydrocarbons, and heavy metals including Cu,

Pb, Cd, and Cr (Rogerson et al. 1984). Despite this large spectrum of contaminants, BRH sediment is not acutely toxic to N. incisa juveniles.

93. The exposure conditions presented in this report do not represent realistic exposure regimes for N. incisa in Long Island Sound. Rather, they were employed to produce a sublethal response. Current research is aimed at establishing the exposure regimes that N. incisa would be exposed to near the Black Rock Harbor site. Once these limits are established, long-term laboratory studies will be conducted with environmental conditions that more closely approximate field conditions.

## PART V: CONCLUSIONS

94. The results of this study indicate that the principles of bioenergetics can be applied to study the effect of sediment disposed on polychaetes. With Nephtys incisa, the physiological measurements were found to be reproducible within a particular treatment. The physiological measurements were also found to be repeatable. In all instances, measurement values from a particular treatment in one experiment were not significantly different from the same treatment in repeated experiments. In most cases, the physiological measures followed a dose-response to additions of BRH sediment. The only exception were the O:N ratios which did not show a response to exposure to BRH sediment.

95. The findings with Neanthes arenaceodentata were not as dramatic as they were for N. incisa. In only one of the three experiments was there a dose-response to additions of BRH sediment.

## REFERENCES

- Aller, R.C., and Yingst, Y.J. 1978. "Biogeochemistry of Tube-dwellings: A Study of the Sedentary Polychaete Amphitrite ornata," Journal of Marine Research, pp 201-254.
- Bayne, B.L. 1975. "Aspects of Physiological Condition in Mytilus edulis (L.), with Special Reference to the Effects of Oxygen Tension and Salinity," Proceedings of 9th European Marine Biology Symposium, H. Barnes, Ed., Aberdeen University Press, Scotland, pp 213-238.
- Bayne, B.L., Moore, M.N., Widdows, J., Livingstone, D.R., and Salkeld, P. 1979. "Measurement of the Responses of Individuals to Environmental Stress and Pollution: Studies With Bivalve Molluscs," Philosophical Transactions Royal Society Series Bulletin, Vol 286, pp 563-581.
- Bower, C.E., and Holm-Hansen, T. 1980. "A Salicylate-Hypochlorite Method for Determining Ammonia in Seawater," Canadian Journal of Fisheries and Aquatic Science, Vol 37, pp 794-798.
- Capuzzo, J.M., and Lancaster, B.A. 1981. "Physiological Effects of South Louisiana Crude Oil on Larvae of the American Lobster (Homarus americanus)," Biological Monitoring of Marine Pollutants, F.J. Vernberg, A. Calabrese, F.P. Thurberg, and W.B. Vernberg, eds., Academic Press, New York, pp 405-424.
- Carey, A. Jr. 1962. "An Ecologic Study of Two Benthic Populations in Long Island Sound," Ph.D. Thesis, Yale University, New Haven, Conn.
- Conover, W.J., and Iman, R.L. 1981. "Rank Transformations as a Bridge Between Parametric and Nonparametric Statistics," The American Statistician, Vol 35(3), pp 124-129.
- Corner, E.D.S., and Cowey, C.B. 1968. "Biochemical Studies on the Production of Marine Zooplankton," Biological Review, Vol 43, pp 393-426.
- Davis, W.R. 1979. "The Burrowing, Feeding and Respiratory Activities of Nephtys incisa Malmgren, 1865 (Polychaeta: Annelida)," Ph.D. Thesis, University of South Carolina.
- Edwards, R.R.C. 1978. "Effects of Water-soluble Oil Fractions on Metabolism, Growth, and Carbon Budget of the Shrimp Crangon crangon," Marine Biology, Vol 46, pp 259-265.
- Elliot, J.M., and Davison W. 1975. "Energy Equivalents of Oxygen Consumption in Animal Energetics," Oecologia, (Berl.), Vol 19, pp 195-201.

Gilfillan, E.S. 1980. "The Use of Scope-for-growth Measurements in Monitoring Petroleum Pollution," Biological Effects of Marine Pollution and the Problems of Monitoring. A.D McIntyre and J.B. Pearce, eds., Rapports Et Proces-Verbaux Ces Reunions Conseil Permanent International Pour L'Exploration Ce La Mer, Vol 179, pp 71-75.

Gilfillan, E.S., and Hanson, S.A. 1975. "Effects of Paralytic Shellfish Poisoning Toxin on the Behavior and Physiology of Marine Invertebrates," Proceedings of the First International Conference of Toxic Dinoflagellates, V.R. LoCicero ed., The Massachusetts Science and Technology Foundation, pp 367-375.

Gilfillan, E.S., Mayo, D., Hanson, S., Donovan, D., and Jiany, L.C. 1976. "Reduction in Carbon Flux in Mya arenaria Caused by a Spill of No. 6 Fuel Oil," Marine Biology, Vol 37, pp 115-123.

Gilfillan, E.S., and Vandermeulen, J.H. 1978. "Alterations in Growth and Physiology of Soft Shell Clams, Mya arenaria Chronically Oiled With Bunker C From Chedabucto Bay, Nova Scotia, 1970-1976," Journal Fisheries Research Board of Canada, Vol 35(5), pp 630-636.

Goodnight, J.H. 1979. "VARCOMP Procedure" SAS Users Guide, J.T. Helwig, and K.A. Council, eds., SAS Institute Inc. Raleigh, N.C., pp 433-436.

International Council for the Exploration of the Sea. 1978. "On the Feasibility of Effects Monitoring," Cooperative Research Report Number 75., ICES, Chalottenlund, Denmark.

Johns, D.M., and Pechenik, J.A. 1980. "Influence of the Water-accommodated Fraction of No. 2 Fuel Oil on Energetics of Cancer irroratus larvae," Marine Biology, Vol 55, pp 247-254.

Johns, D.M., and Miller, D.C. 1982. "The Use of Bioenergetics to Investigate the Mechanisms of Pollutant Toxicity in Crustacean Larvae," Physiological Mechanisms of Marine Pollutant Toxicity, W.B. Vernberg, A. Calabrese, F.P. Thurberg, and F.J. Vernberg, eds., Academic Press, New York, pp 261-288.

Kay, D.G., and Brafield, A.E. 1973. "The Energy Relations of the Polychaete Neanthes (=Nereis) virens (Sars)," Journal of Animal Ecology, Vol 42, pp 673-692.

Lake, J., Hoffman, G., and Schimmel, S. 1984. "Bioaccumulation of Contaminants from Black Rock Harbor Dredged Material by Mussels and Polychaetes," Technical Report D-84- , prepared by the U.S. Environmental Protection Agency, Environmental Research Laboratory, Narragansett, R.I., for the US Army Engineer Waterways Experiment Station, Vicksburg, Miss.

- Logan, D.T., and Epifanio, C.E. 1978. "A Laboratory Energy Balance for the Larvae and Juveniles of the American Lobster, Homarus americanus," Marine Biology, Vol 47, pp 381-389.
- Maciolek, J.L. 1962. "Limnological Organic Analysis by Quantitative Dichromate Oxidation," Fisheries Research Report Number 60, pp 1-61.
- McIntyrne, A.D., and Pearce, J.B. (eds), 1980. "Biological Effects of Marine Pollution and the Problems of Monitoring." Rapports Et Proces-Verbaux Ces Reunions Conseil Permanent International Pour L'Exploration Ce La Mer, Vol 179.
- McKinney, C.L., Jr. 1982. "Interrelationships Between Energy Metabolism, Growth Dynamics, and Reproduction During the Life Cycle of Mysidopsis bahia as Influenced by Sublethal Endrin Exposure," Physiological Mechanisms of Marine Pollutant Toxicity, W.B. Vernberg, A. Calabrese, F.P. Thurberg, and F.J. Vernberg, eds., Academic Press, New York, pp 447-476.
- Neuhoff, H.-G. 1979. "Influence of Temperature and Salinity on Food Conversion and Growth of Different Nereis Species (Polychaeta, Annelida)," Marine Ecology Progress Series, Vol 1, pp 255-262.
- Pandian, T.J. 1975. "Mechanisms of Heterotrophy," Marine Ecology, Vol. II. Physiological Mechanisms, Part 1, O. Kinne, ed. Wiley, Chichester, pp 61-250.
- Pesch, C.E., and Hoffman, G.L. 1983. "Interlaboratory Comparison of a 28-day Toxicity Test With the Polychaete Neanthes arenaceodentata," Aquatic Toxicology and Hazard Assessment: Sixth Symposium, ASTM STP 802. W.E. Bishop, R.D. Cardwell and B.B. Heidolph, eds., American Society for Testing and Materials, Philadelphia, pp 482-493.
- Rhoads, D.C., and Germano, J.D. 1982. "Characterization of Organism-sediment Relations Using Sediment Profile Imaging: An Efficient Method of Remote Ecological Monitoring of the Seafloor (Remots (TM) System)," Marine Ecology Progress Series, Vol 8, pp 115-128.
- Rogerson, P., Schimmel, S., and Hoffman, G. 1984. "Chemical and Biological Characterization of Black Rock Harbor Dredged Material," Technical Report D-84-, prepared by U.S. Environmental Protection Agency, Narragansett, R.I., for the U.S. Army Engineer Waterways Experiment Station, CE, Vicksburg, Miss.
- Rubinstein, N. 1979. "A Benthic Bioassay Using Time-lapsed Photography to Measure the Effect of Toxicants on the Feeding Behavior of Lugworms (Polychaeta: Arenicolida)," Marine Pollution: Functional Responses. W.B. Vernberg, F.P. Thurberg, A. Calabrese, and F.J. Vernberg, eds., Academic Press, New York, pp 341-351.

Sanders, H.L. 1956. "Oceanography of Long Island Sound. X. The Biology of Bottom Marine Communities," Bulletin Binghamton Oceanography Collection, Vol 15, pp 345-414.

Sanders, H.L. 1958. "Benthic Studies in Buzzards Bay. I. Animal-sediment Relationships," Limnology and Oceanography, Vol 3(3), pp 245-253.

Schauer, P.S., and Pesch, C.E. In Prep. "Influence of Diet on Growth, Survival and Tube Production of Laboratory Cultured Polychaete Neanthes arenaceodentata."

Snedecor, G.W., and Cochran, W.G. 1980. "Statistical Methods," Iowa State University Press, Ames.

Tenore, K.R., and Gopalan, U.K. 1974. "Feeding Efficiencies of the Polychaete Nereis virens Cultured on Hard-clam Tissue and Oyster Detritus," Journal Fisheries Research Board of Canada, Vol 31, pp 1675-1678.

Warren, C.E., and Davis, G.E. 1967. "Laboratory Studies on the Feeding, Bioenergetics and Growth of Fish," The Biological Basis of Freshwater Fish Production, S.D. Gerking, ed., Blackwell, Oxford, pp 175-214.

Yingst, J.Y., and Rhoads, D.C. 1980. "The Role of Bioturbation in the Enhancement of Microbial Turnover Rates in Marine Sediments," Marine Benthic Dynamics, K.R. Tenore and B.C. Coull, eds., University of South Carolina Press, Columbia, pp 407-421.



APPENDIX A: SOLID PHASE AND PARTICULATE PHASE DATA SHEETS

LABORATORY WORM DATA SHEET  
 CGE/ERLN FVP

STUDY PLAN: 3

INVESTIGATOR: JOHNS/GUTJAHR

EXPERIMENT DESCRIPTION: SOLID

DATE OF TEST: 821014

SPECIES: NEPHTYS INCISA

\*\* EXPERIMENTAL CONDITIONS \*\*

TEMPERATURE: 21.00 DEGREES CENTIGRADE RANGE: 20.50 - 21.50  
 SALINITY: 28.00 PARTS PER THOUSAND RANGE: 28.00 - 29.00  
 EXPOSURE DURATION: 10 DAYS  
 PHOTOPERIOD: 13 HOURS  
 FLOW RATE: 50 MLS/MIN VOLUME ADDITIONS/DAY:  
 NUMBER OF ANIMALS/REPLICATE: 15 NUMBER OF REPLICATES/TREATMENT: 1  
 ANIMAL'S LIFE STAGE: JUVENILE  
 SIZE: 1.39 +/- 0.21 MG DRY WT  
 CONTROLS: 100 PERCENT REF  
 FOOD: PRAWN FLAKE SUSPENSION  
 ANIMAL SOURCE: SOUTH REFERENCE, LONG ISLAND SOUND  
 COLLECTION TEMPERATURE: 19.5 C COLLECTION SALINITY: 29  
 ACCLIMATION: 20 C.

SEDIMENT SOURCE: BARREL OR COLLECTION/JAR NUMBER

SOLID REFERENCE: II/50

SOLID BRH: LL/25

SUSPENDED REFERENCE:

SUSPENDED BRH:

SAMPLE NUMBER	EXPOSURE CONCENTRATIONS		GROWTH		RESPIRATORY ENERGY EXPENDITURE		EXCRETORY ENERGY LOSS		NET GROWTH EFFICIENCY	
	NOMINAL	MEASURED	MEAN	+/-STD	MEAN	+/-STD	MEAN	+/-STD	MEAN	+/-STD
400020	100 PERCENT REF		.87	.07	6.1	1.8	0.04	0.01	17	10
400021	50:50 REF:BRH		-.54	.11	5.3	2.1	0.03	0.01	-5	14
400022	100 PERCENT BRH		-5.33	.54	6.5	2.8	0.02	0.01	-60	20

LABORATORY WORM DATA SHEET  
COE/ERLN FVP

STUDY PLAN: 3

INVESTIGATOR: JOHNS/GUTJAHR

EXPERIMENT DESCRIPTION: SOLID

DATE OF TEST: 821203

SPECIES: NEPHTYS INCISA

\*\* EXPERIMENTAL CONDITIONS \*\*

TEMPERATURE: 20.50 DEGREES CENTIGRADE RANGE: 20.00 - 21.50

SALINITY: 30.00 PARTS PER THOUSAND RANGE: 28.50 - 31.00

EXPOSURE DURATION: 10 DAYS

PHOTOPERIOD: 13 HOURS

FLOW RATE: 50 MLS/MIN

VOLUME ADDITIONS/DAY:

NUMBER OF ANIMALS/REPLICATE: 15 NUMBER OF REPLICATES/TREATMENT: 1

ANIMAL'S LIFE STAGE: JUVENILE

SIZE: 1.40 +/- 0.33 MG DRY WT

CONTROLS: 100 PERCENT REF

FOOD: FRAWN FLAKE SUSPENSION

ANIMAL SOURCE: SOUTH REFERENCE, LONG ISLAND SOUND

COLLECTION TEMPERATURE: 6.7 C

COLLECTION SALINITY: 29

ACCLIMATION: 20 C.

SEDIMENT SOURCE: BARREL OR COLLECTION/JAR NUMBER

SOLID REFERENCE: II/50

SOLID BRH: LL/25

SUSPENDED REFERENCE:

SUSPENDED BRH:

SAMPLE NUMBER	EXPOSURE CONCENTRATIONS		GROWTH JOULES	RESPIRATORY ENERGY EXPENDITURE JOULES	EXCRETORY ENERGY LOSS JOULES	NET GROWTH EFFICIENCY IN PERCENT
	NOMINAL	MEASURED				
			MEAN +/- STD	MEAN +/- STD	MEAN +/- STD	MEAN +/- STD
400023	100 PERCENT REF		5.87   .47	13.5   3.7	0.04   0.01	30   8
400025	50:50 REF: BRH		4.13   1.2	11.3   2.9	0.03   0.01	26   7
400027	100 PERCENT BRH		-0.04   .0	5.3   1.2	0.02   0.01	-1   4

LABORATORY WORM DATA SHEET  
COE/ERLN FVP

STUDY PLAN: 3

INVESTIGATOR: JOHNS/GUTJAHR

EXPERIMENT DESCRIPTION: SOLID

DATE OF TEST: 821203

SPECIES: NEPHTYS INCISA

\*\* EXPERIMENTAL CONDITIONS \*\*

TEMPERATURE: 20.50 DEGREES CENTIGRADE RANGE: 20.00 - 21.50

SALINITY: 30.00 PARTS PER THOUSAND RANGE: 28.50 - 31.00

EXPOSURE DURATION: 10 DAYS

PHOTOPERIOD: 13 HOURS

FLOW RATE: 50 M<sup>3</sup>/MIN

VOLUME ADDITIONS/DAY:

NUMBER OF ANIMALS/REPLICATE: 15 NUMBER OF REPLICATES/TREATMENT: 1

ANIMAL'S LIFE STAGE: JUVENILE

SIZE: 1.45 +/- 0.73 MG DRY WT

CONTROLS: 100 PERCENT REF

FOOD: PRAWN FLAKE SUSPENSION

ANIMAL SOURCE: SOUTH REFERENCE, LONG ISLAND SOUND

COLLECTION TEMPERATURE: 6.7 C

COLLECTION SALINITY: 29

ACCLIMATION: 20 C.

SEDIMENT SOURCE: BARREL OR COLLECTION/JAR NUMBER

SOLID REFERENCE: II/50

SOLID BRH: LL/25

SUSPENDED REFERENCE:

SUSPENDED BRH:

SAMPLE NUMBER	EXPOSURE CONCENTRATIONS		GROWTH JOULES		RESPIRATORY ENERGY EXPENDITURE JOULES		EXCRETORY ENERGY LOSS JOULES		NET GROWTH EFFICIENCY IN PERCENT	
	NOMINAL	MEASURED	MEAN +/- STD	MEAN +/- STD	MEAN +/- STD	MEAN +/- STD	MEAN +/- STD	MEAN +/- STD	MEAN +/- STD	MEAN +/- STD
400036	100 PERCENT REF		4.04	.73	11.8	2.5	0.04	0.01	25	5
400037	50:50 REF:BRH		0.65	.16	6.2	1.3	0.03	0.01	10	2
400038	100 PERCENT BRH		-1.85	.17	3.3	2.5	0.02	0.01	-24	14

LABORATORY WORM DATA SHEET  
CGE/ERLN FVP

STUDY PLAN: 3

INVESTIGATOR: JOHNS/GUTJAHR

EXPERIMENT DESCRIPTION: SUSPENDED

DATE OF TEST: 830902

SPECIES: NEPHTYS INCISA

\*\* EXPERIMENTAL CONDITIONS \*\*

TEMPERATURE: 21.20 DEGREES CENTIGRADE RANGE: 20.50 - 22.50

SALINITY: 30.50 PARTS PER THOUSAND RANGE: 30.00 - 31.00

EXPOSURE DURATION: 10 DAYS

PHOTOPERIOD: 13 HOURS

FLOW RATE: 35 MLS/MIN

VOLUME ADDITIONS/DAY: 67

NUMBER OF ANIMALS/REPLICATE: 15 NUMBER OF REPLICATES/TREATMENT: 1

ANIMAL'S LIFE STAGE: JUVENILE

SIZE: 3.13 +/- 0.60 MG DRY WT

CONTROLS: 200 MG/L REF/REF

FOOD: PRAWN FLAKE SUSPENSION

ANIMAL SOURCE: SOUTH REFERENCE, LONG ISLAND SOUND

COLLECTION TEMPERATURE: 20.5 C

COLLECTION SALINITY: 28.8

ACCLIMATION: 20 C.

SEDIMENT SOURCE: BARREL OR COLLECTION/JAR NUMBER

SOLID REFERENCE: III/19

SOLID BRH: EE/5,8

SUSPENDED REFERENCE: III/19,21,22

SUSPENDED BRH: EE/7,11,12

SAMPLE NUMBER	EXPOSURE CONCENTRATIONS		GROWTH		RESPIRATORY	EXCRETORY	NET GROWTH			
	NOMINAL	MEASURED	JOULES	JOULES	ENERGY EXPENDITURE	ENERGY LOSS	EFFICIENCY	IN PERCENT		
			MEAN +/- STD	MEAN +/- STD	MEAN +/- STD	MEAN +/- STD	MEAN +/- STD	MEAN +/- STD		
400130	200MG/L REF/REF	211+87	6.09	1.22	14.1	4.7	0.08	0.01	35	5
400131	200MG/L BRH/REF	171+53	4.35	.96	13.7	3.2	0.08	0.02	24	5
400132	200MG/L REF/BRH	211+87	5.00	1.10	10.2	4.7	0.05	0.01	36	22
400133	200MG/L BRH/BRH	171+53	-2.50	.78	9.0	3.5	0.04	0.01	-78	48

LABORATORY WORK DATA SHEET  
CGE/ERLN FVP

STUDY PLAN: 3

INVESTIGATOR: JOHNS/OUTJAHR

EXPERIMENT DESCRIPTION: SUSPENDED

DATE OF TEST: 830920

SPECIES: NEPHTYS INCISA

\*\* EXPERIMENTAL CONDITIONS \*\*

TEMPERATURE: 20.60 DEGREES CENTIGRADE RANGE: 19.80 - 22.00

SALINITY: 30.70 PARTS PER THOUSAND RANGE: 30.00 - 31.80

EXPOSURE DURATION: 10 DAYS

PHOTOPERIOD: 13 HOURS

FLOW RATE: 32 MLS/MIN

VOLUME ADDITIONS/DAY: 61

NUMBER OF ANIMALS/REPLICATE: 15 NUMBER OF REPLICATES/TREATMENT: 1

ANIMAL'S LIFE STAGE: JUVENILE

SIZE: 3.43 +/- 0.92 MG DRY WT

CONTROLS: 200 MG/L REF/REF

FOOD: PRAWN FLAKE SUSPENSION

ANIMAL SOURCE: SOUTH REFERENCE, LONG ISLAND SOUND

COLLECTION TEMPERATURE: 21.6 C

COLLECTION SALINITY: 29.2

ACCLIMATION: 20 C.

SEDIMENT SOURCE: BARREL OR COLLECTION/JAR NUMBER

SOLID REFERENCE: III/25

SOLID BRH: EE/17

SUSPENDED REFERENCE: III/6,7,36

SUSPENDED BRH: EE/8,10,14

SAMPLE NUMBER	EXPOSURE CONCENTRATIONS		GROWTH		RESPIRATORY ENERGY EXPENDITURE		EXCRETORY ENERGY LOSS		NET GROWTH EFFICIENCY	
	NOMINAL	MEASURED	MEAN	+/-STD	MEAN	+/-STD	MEAN	+/-STD	MEAN	+/-STD
400134	200MG/L REF/REF	198+73	13.38	.94	17.8	4.4	0.07	0.01	44	7
400135	200MG/L BRH/REF	226+48	8.48	1.36	18.5	5.8	0.07	0.03	33	7
400136	200MG/L REF/BRH	198+73	5.11	.92	12.2	2.8	0.07	0.02	29	4
400137	200MG/L BRH/BRH	226+48	1.41	.27	10.6	2.5	0.05	0.01	12	2

LABORATORY WORM DATA SHEET  
COE/ERLN FVP

STUDY PLAN: 3

INVESTIGATOR: JOHNS/GUTJAHR

EXPERIMENT DESCRIPTION: SOLID

DATE OF TEST: 830516

SPECIES: NEANTHES ARENACEODENTATA

\*\* EXPERIMENTAL CONDITIONS \*\*

TEMPERATURE: 21.00 DEGREES CENTIGRADE RANGE: 20.50 - 21.50  
 SALINITY: 28.00 PARTS PER THOUSAND RANGE: 28.00 - 29.00  
 EXPOSURE DURATION: 10 DAYS  
 PHOTOPERIOD: 13 HOURS  
 FLOW RATE: 100 HLS/MIN VOLUME ADDITIONS/DAY 67  
 NUMBER OF ANIMALS/REPLICATE: 15 NUMBER OF REPLICATES/TREATMENT: 1  
 ANIMAL'S LIFE STAGE: JUVENILE AGE: 41 DAYS  
 SIZE: 4.16 +/- 1.73 MG DRY WT  
 CONTROLS: 100 PERCENT REF  
 FOOD: PRAWN FLAKE SUSPENSION  
 ANIMAL SOURCE: CULTURE  
 COLLECTION TEMPERATURE: COLLECTION SALINITY:  
 ACCLIMATION: 20 C.  
 SEDIMENT SOURCE: BARREL OR COLLECTION/JAR NUMBER  
 SOLID REFERENCE: II/50 SOLID BRH: LL/25  
 SUSPENDED REFERENCE: SUSPENDED BRH:

SAMPLE NUMBER	EXPOSURE CONCENTRATIONS		GROWTH JOULES		RESPIRATORY ENERGY EXPENDITURE		EXCRETORY ENERGY LOSS		NET GROWTH EFFICIENCY	
	NOMINAL	MEASURED	MEAN +/- STD	MEAN +/- STD	MEAN +/- STD	MEAN +/- STD	MEAN +/- STD	MEAN +/- STD	MEAN +/- STD	MEAN +/- STD
400028	100 PERCENT REF		22	20	38	9	0.06	0.02	29	34
400029	50:50 REF:BRH		14	19	30	11	0.03	0.02	18	42
400030	100 PERCENT BRH		13	14	23	3	0.04	0.01	27	32

LABORATORY WORM DATA SHEET  
COE/ERLN FVP

STUDY PLAN: 3

INVESTIGATOR: JOHNS/GUTJAHR

EXPERIMENT DESCRIPTION: SUSPENDED

DATE OF TEST: 830922

SPECIES: NEANTHES ARENACEODENTATA

\*\* EXPERIMENTAL CONDITIONS \*\*

TEMPERATURE: 20.60 DEGREES CENTIGRADE RANGE: 19.80 - 22.00

SALINITY: 30.70 PARTS PER THOUSAND RANGE: 30.00 - 31.80

EXPOSURE DURATION: 10 DAYS

PHOTOPERIOD: 13 HOURS

FLOW RATE: 33 MLS/MIN

VOLUME ADDITIONS/DAY 63

NUMBER OF ANIMALS/REPLICATE: 15 NUMBER OF REPLICATES/TREATMENT: 1

ANIMAL'S LIFE STAGE: JUVENILE AGE: 42 DAYS

SIZE: 3.52 +/- 2.09 MG DRY WT

CONTROLS: 200 MG/L REF/REF

FOOD: PRAWN FLAKE SUSPENSION

ANIMAL SOURCE: CULTURE

COLLECTION TEMPERATURE:

COLLECTION SALINITY:

ACCLIMATION: 20 C.

SEDIMENT SOURCE: BARREL OR COLLECTION/JAR NUMBER

SOLID REFERENCE: III/25,26

SOLID BRH: EE/17,18

SUSPENDED REFERENCE: III/6,7,36

SUSPENDED BRH: EE/8,10,14

SAMPLE NUMBER	EXPOSURE CONCENTRATIONS		GROWTH		RESPIRATORY ENERGY EXPENDITURE		EXCRETORY ENERGY LOSS		NET GROWTH EFFICIENCY	
	NOMINAL	MEASURED	MEAN	+/-STD	MEAN	+/-STD	MEAN	+/-STD	MEAN	+/-STD
400138	200MG/L REF/REF	199 + 73	39	38	57	13	0.08	0.04	30	27
400139	200MG/L BRH/REF	222 + 44	49	40	54	13	0.14	0.05	41	20
400140	200MG/L REF/BRH	199 + 73	45	27	61	8	0.11	0.03	39	16
400141	200MG/L BRH/BRH	222 + 44	37	32	62	7	0.13	0.07	31	23



LABORATORY WORM DATA SHEET  
COE/ERLN FVP

STUDY PLAN: 3

INVESTIGATOR: JOHNS/GUTJAHR

EXPERIMENT DESCRIPTION: SUSPENDED

DATE OF TEST: 830816

SPECIES: NEANTHES ARENACEODENTATA

\*\* EXPERIMENTAL CONDITIONS \*\*

TEMPERATURE: 21.00 DEGREES CENTIGRADE RANGE: 20.50 - 21.50  
 SALINITY: 30.00 PARTS PER THOUSAND RANGE: 30.00 - 31.00  
 EXPOSURE DURATION: 10 DAYS  
 PHOTOPERIOD: 13 HOURS  
 FLOW RATE: 35 MLS/MIN VOLUME ADDITIONS/DAY 67  
 NUMBER OF ANIMALS/REPLICATE: 15 NUMBER OF REPLICATES/TREATMENT: 1  
 ANIMAL'S LIFE STAGE: JUVENILE AGE: 57 DAYS  
 SIZE: 4.43 +/- 0.092 MG DRY WT  
 CONTROLS: 200 MG/L REF/REF  
 FOOD: PRAWN FLAKE SUSPENSION  
 ANIMAL SOURCE: CULTURE  
 COLLECTION TEMPERATURE: COLLECTION SALINITY:  
 ACCLIMATION: 20 C.  
 SEDIMENT SOURCE: BARREL OR COLLECTION/JAR NUMBER  
 SOLID REFERENCE: III/13,14 SOLID BRH: EE/1,2  
 SUSPENDED REFERENCE: III/13-17 SUSPENDED BRH: EE/1-5

SAMPLE NUMBER	EXPOSURE CONCENTRATIONS		GROWTH		RESPIRATORY	EXCRETORY	NET GROWTH			
	NOMINAL	MEASURED	JOULES		ENERGY EXPENDITURE	ENERGY LOSS	EFFICIENCY			
			MEAN	+/-STD	MEAN	+/-STD	MEAN	+/-STD		
400126	200MG/L REF/REF	217 + 86	36	33	52	6	0.08	0.02	35	19
400127	200MG/L REF/BRH	190 + 61	38	39	56	10	0.08	0.03	34	24
400128	200MG/L BRH/REF	217 + 86	38	31	53	6	0.14	0.03	35	20
400129	200MG/L BRH/BRH	190 + 61	3	14	47	9	0.11	0.03	3	23