

**Cold Regions Research  
and Engineering Laboratory**

**ERDC/CRREL TR-00-13**

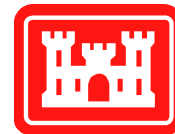

**US Army Corps  
of Engineers®**  
Engineer Research and  
Development Center

# **Assessment of Millennium Pipeline Project Lake Erie Crossing**

**Ice Scour, Sediment Sampling, and Turbidity Modeling**

James H. Lever, Editor

August 2000

**Abstract:** ERDC researchers assessed the Millennium Pipeline Project on three topics related to its proposed crossing of Lake Erie: 1) the potential for pipeline damage by ice scour, 2) adequacy of the sampling program to identify contaminated sediments, and 3) adequacy of the modeling for turbidity and sediment deposition resulting from pipeline-trench excavation.

Inclusion of additional scour data and re-analysis resulted in a 25% increase in the estimated 100-year scour depth near the U.S. shore and a consequent increase in the design trench depth by about 20%. Question-answer exchanges resolved ERDC concerns regarding sediment sampling and turbidity/deposition modeling.

**How to get copies of CRREL technical publications:**

Department of Defense personnel and contractors may order reports through the Defense Technical Information Center:

DTIC-BR SUITE 0944  
8725 JOHN J KINGMAN RD  
FT BELVOIR VA 22060-6218  
Telephone (800) 225-3842  
E-mail help@dtic.mil  
msorders@dtic.mil  
WWW <http://www.dtic.mil/>

All others may order reports through the National Technical Information Service:

NTIS  
5285 PORT ROYAL RD  
SPRINGFIELD VA 22161  
Telephone (703) 487-4650  
(703) 487-4639 (TDD for the hearing-impaired)  
E-mail orders@ntis.fedworld.gov  
WWW <http://www.ntis.gov/index.html>

A complete list of all CRREL technical publications is available from

USACRREL (CEERD-IM-HL)  
72 LYME RD  
HANOVER NH 03755-1290  
Telephone (603) 646-4338  
E-mail erhoff@crrel.usace.army.mil

**For information on all aspects of the Cold Regions Research and Engineering Laboratory, visit our World Wide Web site:**

<http://www.crrel.usace.army.mil>

Technical Report  
ERDC/CRREL TR-00-13

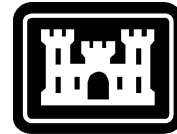

**US Army Corps  
of Engineers®**  
Cold Regions Research &  
Engineering Laboratory

# **Assessment of Millennium Pipeline Project Lake Erie Crossing**

**Ice Scour, Sediment Sampling, and Turbidity Modeling**

James H. Lever, Editor

August 2000

Prepared for  
MILLENNIUM PIPELINE COMPANY

Approved for public release; distribution is unlimited.

## **PREFACE**

This report was edited by Dr. James H. Lever, Mechanical Engineer, Ice Engineering Research Division, Cold Regions Research and Engineering Laboratory (CRREL), U.S. Army Engineer Research and Development Center. Funding for this work was provided by Millennium Pipeline Company as part of a Cooperative Research and Development Agreement with CRREL and U.S. Army Engineer District, Pittsburgh.

## CONTENTS

<a href="#">Preface</a> .....	<a href="#">ii</a>
<a href="#">Executive summary</a> .....	<a href="#">vi</a>
<a href="#">Participants</a> .....	<a href="#">viii</a>
<a href="#">1.0 Introduction</a> .....	<a href="#">1</a>
<a href="#">2.0 Scope and technical issues</a> .....	<a href="#">1</a>
<a href="#">2.1 U.S. side focus</a> .....	<a href="#">1</a>
<a href="#">2.2 Ice scour issues</a> .....	<a href="#">1</a>
<a href="#">2.3 Sediment sampling and deposition/turbidity modeling</a> .....	<a href="#">3</a>
<a href="#">3.0 Summary of ice scour data</a> .....	<a href="#">3</a>
<a href="#">3.1 Zone definitions and focus of data review</a> .....	<a href="#">3</a>
<a href="#">3.2 Ice scour depth distribution</a> .....	<a href="#">4</a>
<a href="#">3.3 Ice scour rates</a> .....	<a href="#">8</a>
<a href="#">3.4 Isolated deep scours</a> .....	<a href="#">8</a>
<a href="#">4.0 Talisman evidence</a> .....	<a href="#">10</a>
<a href="#">4.1 Overview of Talisman pipeline network</a> .....	<a href="#">10</a>
<a href="#">4.2 Ice damage events</a> .....	<a href="#">11</a>
<a href="#">4.3 Damage frequency for entire Talisman network</a> .....	<a href="#">11</a>
<a href="#">4.4 Damage frequency for Talisman subset near the Millennium route</a> .....	<a href="#">11</a>
<a href="#">4.5 Inference for scour frequency along Millennium pipeline route</a> .....	<a href="#">12</a>
<a href="#">4.6 Inference for scour depth distribution</a> .....	<a href="#">12</a>
<a href="#">5.0 Design scour depth</a> .....	<a href="#">12</a>
<a href="#">5.1 Strategy</a> .....	<a href="#">12</a>
<a href="#">5.2 Design scour depth</a> .....	<a href="#">15</a>
<a href="#">5.3 Sensitivity and benchmark analyses</a> .....	<a href="#">17</a>
<a href="#">5.4 Summary of revisions to design scour depth</a> .....	<a href="#">19</a>
<a href="#">6.0 Pipe response and trench depth</a> .....	<a href="#">19</a>
<a href="#">6.1 Introduction</a> .....	<a href="#">19</a>
<a href="#">6.2 Pipe-response model overview</a> .....	<a href="#">19</a>
<a href="#">6.3 ERDC/CRREL review</a> .....	<a href="#">22</a>
<a href="#">6.4 Revised trench depth recommendations</a> .....	<a href="#">22</a>
<a href="#">6.5 Model conservatism</a> .....	<a href="#">23</a>
<a href="#">6.6 Responses to specific ERDC review questions</a> .....	<a href="#">25</a>
<a href="#">7.0 Pipeline monitoring and repair</a> .....	<a href="#">28</a>
<a href="#">7.1 As-built survey</a> .....	<a href="#">28</a>
<a href="#">7.2 Continuous monitoring</a> .....	<a href="#">28</a>
<a href="#">7.3 Internal and external inspections</a> .....	<a href="#">28</a>
<a href="#">8.0 Sediment sampling</a> .....	<a href="#">29</a>
<a href="#">8.1 Overview of sediment-quality sampling program</a> .....	<a href="#">30</a>
<a href="#">8.2 Concerns raised during public comment</a> .....	<a href="#">30</a>
<a href="#">8.3 Concerns addressed during ERDC review</a> .....	<a href="#">31</a>

8.4 Status of concerns .....	35
9.0 Turbidity modeling .....	36
9.1 Overview of turbidity modeling .....	36
9.2 Concerns addressed during the ERDC review .....	37
9.3 ERDC/EL turbidity modeling .....	44
9.4 Status of concerns .....	45
10.0 Summary and conclusions .....	45
Literature cited .....	47
Appendix A: Documents reviewed .....	49
Appendix B: MPC email of March 16, 2000 .....	51
Appendix C: Letter of September 22, 1999, from Talisman Energy to Transcanada Transmission .....	53
Appendix D: Jim Grass email of March 30, 2000 .....	55
Abstract .....	57

## ILLUSTRATIONS

### Figure

3.1. Millennium pipeline zones in U.S. waters .....	3
3.2. Cross section of Millennium pipeline route showing revised zone definitions .....	4
3.3. Survey routes for U.S. Geological Survey cruises 1991–1993 .....	7
3.4. Lakebed bathymetry showing pipeline route and approximate location of “ice island” scour .....	9
4.1 Millennium pipeline route, Talisman gas pipelines on the seabed, and recorded dates of pipeline damage .....	10
5.1. Depth distribution of “new” scours compiled from 1995 Ohio Geological Survey data .....	13
5.2 Depth distribution of “new” scours compiled from Ontario Hydro 1981 and 1982 surveys (Coho) and from Canadian Seabed Research 1998 route survey .....	14
5.3. Depth distribution of “new” scours compiled from the Ontario Hydro 1981 and 1982 surveys (Coho), from the Ohio 1995 survey, and from the Canadian Seabed Research 1998 route survey .....	14
5.4. Exponential fit to depth distribution of “new” scours compiled from Ontario Hydro 1981 and 1982 surveys (Coho), from Ohio Geological Survey 1995 survey, and from Canadian Seabed Research 1998 route survey .....	16
6.1. Schematic of finite-element model and geometric boundary condition .....	20
6.2. Plan view of the horizontal profile sub-scour soil displacement .....	20
6.3. Progression of scouring ice keel–trench interaction .....	21
6.4. Transverse horizontal load-displacement relationship for Case X .....	23
6.5. Transverse horizontal soil reaction load for Case X .....	24
6.6. Profile of the imposed subgouge displacement field and computed pipeline displacement response for Case X .....	24
6.7. Longitudinal distribution of axial strain for Case X .....	25

## TABLES

### Table

3.1. Original and revised Millennium pipeline zones in U.S. waters .....	4
3.2. Expanded ice scour data set relevant to Millennium pipeline route .....	5
3.3. Summary of “new” scour depth data for Lake Erie .....	6
3.4. Scour depth distribution from 1995 Ohio Geological Survey data .....	7
4.1. Water depth distribution .....	11
5.1. Millennium pipeline zones in U.S. waters defined in C-CORE .....	16
5.2. Revised 10-year and 100-year scour depths for Millennium pipeline zones in U.S. waters .....	17
6.1. Summary of recommendations revised .....	22
6.2. Models supporting trench depth recommendations .....	23
8.1. Sources and sinks of metals in Lake Erie .....	31
8.2. Correlation of metals, PCBs, and organic carbon in Lake Erie sediments .....	32
8.3. Correlation of metals and organic carbon in composite sediment core samples collected along the Millennium Lake Erie Crossing route .....	33
8.4. Mean concentrations of metals in precolonial sediments and in the composite sediment cores collected along the proposed pipeline route .....	33
8.5. Sedimentation rates in eastern basin of Lake Erie .....	34
8.6. Surficial sediment core sample logs .....	35
(9.) 1. Deposition for unidirectional spreading .....	45
(9.) 2. Deposition for bi-directional spreading .....	45
10.1. Revised 100-year scour depths and design trench depths for Millennium pipeline zones in U.S. waters .....	46

## EXECUTIVE SUMMARY

The Millennium Pipeline Project includes a crossing of Lake Erie to bring Canadian natural gas to markets in the eastern United States. Millennium proposes to lay this 1.07-m-diameter, concrete-coated pipeline in a trench excavated in the lakebed to protect it from scouring ice keels, fishing gear, and anchors.

In response to a request from the Federal Energy Regulatory Commission, researchers at ERDC assessed Millennium's work on three topics related to the Lake Erie crossing:

- The potential for pipeline damage by ice scour.
- The adequacy of the sampling program to identify contaminated sediments.
- The adequacy of the modeling for turbidity and sediment deposition resulting from trench excavation.

This assessment focused on the pipeline zones in U.S. waters and was conducted in collaboration with Millennium, its partners, and the Pittsburgh District, Corps of Engineers.

High winds on Lake Erie can fracture and pile ice into large ridges. Ice scour occurs when the keels of these ridges drag along the lakebed. To avoid damage, a pipeline must be designed to withstand the forces from an ice scour expected to cross the pipeline, on average, once in 100 years. The design trench depth must place the pipe crown sufficiently below the scour depth to keep pipe deformations within acceptable limits.

Determination of the 100-year ice scour depth was the only issue that required additional analyses to satisfy the concerns of the ERDC reviewers. The original analyses relied solely on data from a single survey along the pipeline route. The ERDC review resulted in two main changes: only new scours were used to determine the scour-depth probability distribution, and scour data from comprehensive surveys nearby the pipeline route were included. These changes increased the estimated 100-year scour depth by 25%, from 1.2 to 1.5 m, in pipeline zones nearest to the U.S. shore (zones H, I, and J). In these zones the design trench depth increased by about 20%, from 2.8 to 3.4 m (Table E1). Ice scour does not control trench depths in deep-water zones F and G, and the originally designed trench depth of 2.0 m is adequate even if it did. Additional benchmark analyses conducted during the ERDC review increase confidence in the estimated scour rates, the scour-depth distribution, and the resulting 100-year scour depths.

The ERDC assessment included the pipe-soil interaction model used to determine the design trench depths given the 100-year scour depth for each zone. This finite-element model relies on results from centrifuge tests and field observations, and it represents the state of the art. A question-answer exchange resolved concerns regarding use of two-dimensional modeling, the choice of soil-stiffness characteristics, and the response of the pipe in a partially backfilled trench. Conservative choices regarding normal incidence angle and keel-pipe load transfer through native soil increase confidence in the model results.

ERDC's assessment of Millennium's sediment-sampling program sought to resolve issues concerning the depth and intensity of sampling and the use of mercury as an indicator contaminant. A question-answer exchange, which included additional data and references, resolved these concerns. No additional sampling or analyses are needed due to increased trench depths because the extra material excavated would be uncontaminated.

ERDC's assessment of Millennium's modeling of turbidity and sediment deposition focused on the modeling methods and the choice of sediment settling velocity. Many specific



issues were resolved through a question–answer exchange. Modeling by ERDC showed that the originally predicted turbidity plume is conservative. However, Millennium will need to update its results to show as much as a factor-of-three short-term increase in the expected thickness of the sediment blanket adjacent to the pipeline trench. A 20% increase in design trench depths would result in a further 10% increase in blanket thickness and a 10% increase in blanket width. The effect on the turbidity plume would depend on the trench excavation rate. Millennium agreed with the results of this review.

The design of the pipeline includes a margin of safety between the maximum tensile strain caused by the 100-year scour (2.5%) and strain needed to rupture the pipe (about 3.8%). Millennium will monitor the pipeline continuously for changes in conditions that could signal damage and would close valves at each side of the lake if a leak occurs. In addition, Millennium will conduct internal and external inspections of the pipeline at approximately three-year intervals (depending on ice conditions) to detect possible damage and to assess the design for ice scour protection. It will also establish procedures (as required by regulation) for emergency response and repair of the pipeline.

In conclusion, the ERDC assessment of Millennium Pipeline Project’s Lake Erie crossing revealed the need for two revisions: a 20% increase in design trench depths in zones H, I, and J, and as much as a threefold short-term increase in expected sediment-blanket thickness adjacent to the excavated trench. Otherwise, the analyses conducted and reports prepared by Millennium pertaining to the three topics assessed are technically sound and satisfy the request for additional information under the Corps of Engineers regulatory review process.

**Table E1. Revised 100-year scour depths and design trench depths for Millennium pipeline zones in U.S. waters. Original scour and trench depths are from C-CORE (1999a), although zone definitions differ slightly.**

<i>Pipeline zone</i>	<i>Distance from Canadian landfall (km)</i>	<i>Start–end water depth range (m)</i>	<i>Original 100-year scour depth (m)</i>	<i>Revised 100-year scour depth (m)</i>	<i>Original design trench depth (m)</i>	<i>Revised design trench depth (m)</i>
F	98.0–105.0	21.0–26.7	0.8*	0.8*	2.0	2.0
G	105.0–135.1	26.7–27.4	0.8*	0.8*	2.0	2.0
H	135.1–136.8	27.4–18.4	1.2	1.5	2.8	3.4
I	136.8–142.2	18.4–16.4	1.2	1.5	2.8	3.4
J	142.2–147.3	16.4–17.1	1.2	1.5	2.8	3.4
ALF	147.3–149.3 (DDA)	17.1–8.3				

ALF: American Landfall

DDA: End of Directionally Drilled Pipe from American Landfall

\* Assigned values based on need to protect pipeline from anchors and fishing gear. Ice scour does not control trench depths for zones F and G.

## **PARTICIPANTS**

### **ERDC Review Team**

Dr. James M. Brannon  
Environmental Laboratory  
Waterways Experiment Station  
Vicksburg, Mississippi 39180-6199

Mr. Scott A. Hans  
U.S. Army Engineer District, Pittsburgh  
Pittsburgh, Pennsylvania 15222-4186

Dr. James H. Lever, Team Leader  
Cold Regions Research and  
Engineering Laboratory  
Hanover, New Hampshire 03755-1290

Dr. Mark S. Dortch  
Environmental Laboratory  
Waterways Experiment Station  
Vicksburg, MS 39180-6199

Dr. Steven A. Ketcham  
Cold Regions Research and  
Engineering Laboratory  
Hanover, New Hampshire 03755-1290

Dr. Paul R. Schroeder  
Environmental Laboratory  
Waterways Experiment Station  
Vicksburg, Mississippi 39180-6199

### **Millennium Participants**

Mr. James R. Albitz  
Columbia Gas Transmission  
Binghamton, New York 13902

Mr. Richard E. Hall, Jr., Coordinator  
Columbia Gas Transmission  
Binghamton, New York 13902  
C-CORE

Mr. Peter Patient  
TransCanada Transmission  
Calgary, Alberta T2P 3P7

Mr. James M. Shearer  
Shearer Consulting  
Ottawa, Ontario K1S 2S8

Dr. Jerry Fitchko  
BEAK International, Inc.  
Brampton, Ontario L6T 5B7

Dr. Richard F. McKenna  
C-CORE  
Memorial University of Newfoundland  
St. John's, Newfoundland A1B 3X5

Dr. Ryan Phillips  
C-CORE  
Memorial University of Newfoundland  
St. John's, Newfoundland A1B 3X5

Mr. Gerard J. Van Arkel  
BEAK International, Inc.  
Brampton, Ontario L6T 5B7

# Assessment of Millennium Pipeline Project Lake Erie Crossing

## Ice Scour, Sediment Sampling, and Turbidity Modeling

JAMES H. LEVER, EDITOR

### 1.0 INTRODUCTION

Millennium Pipeline Company (Millennium) proposes to construct and operate a pipeline to transport Canadian natural gas to markets in the eastern United States. The project includes a crossing of Lake Erie, from Patrick Point, Ontario, to a location close to the Town of Ripley, New York, a length of about 150 km. The pipeline would consist of 0.91-m-diameter steel pipe, with a 7.5-cm concrete coating for stability. Millennium proposes to lay this pipeline in a trench excavated in the lakebed to protect it from scouring ice keels, fishing gear, and anchors.

The Federal Energy Regulatory Commission (FERC) received numerous public comments in response to its Draft Environmental Impact Statement on the Millennium project (FERC 1999). FERC requested technical assistance from the U.S. Army Corps of Engineers (USACE) to address comments on three topics related to the Lake Erie crossing:

- The potential for pipeline damage by ice scour.
- The adequacy of the sampling program to identify contaminated sediments.
- The adequacy of the modeling for turbidity and sediment deposition and resulting from trench excavation.

The U.S. Army Engineer Research and Development Center (ERDC), in collaboration with Millennium, its partners, and the Pittsburgh District, Corps of Engineers, assessed Millennium's work on these three topics. ERDC researchers at the Cold Regions Research and Engineering Laboratory (CRREL) assessed the design for ice scour, while researchers at the Environmental

Laboratory (EL) assessed the sediment sampling program and turbidity modeling.

Each ERDC group reviewed Millennium project materials, public comments, and the open literature related to its topic. As needed, these groups requested clarification or additional analyses by Millennium on specific issues and conducted their own independent analyses. This report describes the findings of the ERDC team and the recommended changes in Millennium project specifications needed to address FERC and USACE permit requirements. Appendix A lists the main project and public-comment documents reviewed.

### 2.0 SCOPE AND TECHNICAL ISSUES

#### 2.1 U.S. side focus

Approximately 98 km of the Millennium pipeline crossing of Lake Erie are in Canadian waters. The remaining 51 km are in U.S. waters and consequently are subject to the regulatory jurisdiction of FERC and USACE. Although geophysical and environmental information from the entire lake was used in ERDC reviews and analyses, the resulting assessments and recommendations are limited to the portion of the project in U.S. waters.

#### 2.2 Ice scour issues

The process of ice scour on Lake Erie is similar to that occurring in the near-shore zones of the U.S. and Canadian Beaufort Seas and other coastal arctic areas (see, for example, Lewis 1977, Weeks et al. 1983, Grass 1984, Niedoroda 1991). On Lake Erie, strong winds can cause ice to fracture and pile up into ridges reaching

10 m high. Subsequent movement of these ridges can cause their keels to drag along the lakebed, producing near-linear furrows or scours. Scours up to 1.5 m deep, 100 m wide, and several kilometers long, in water depths up to 27.4 m, have been observed. Ice scouring in Lake Erie is episodic, with high spatial and temporal variability of scour formation and infilling by sediments.

No operational marine pipelines exist that were designed to resist damage by scouring ice keels. Nevertheless, a consensus exists regarding design procedures (Weeks et al. 1983, Niedoroda 1991, Woodworth-Lynas et al. 1996). The Northstar oil pipeline in the Beaufort Sea near Prudhoe Bay, Alaska, was so designed (INTEC 1998a, 1998b), received USACE permits, and was recently constructed. Codes for marine pipelines recognize the random nature of environmental loads and require designing for such loads with an expected annual risk of 0.01, equivalent to a return period of 100 years (ASME 1995, CSA 1999). For loads due to scouring ice keels, the design process basically is as follows:

- Predict the 100-year ice scour depth along the proposed route.
- Predict the soil deformation resulting from that scour.
- Select a combination of trench depth and pipe design to ensure that pipe deformation in response to this event is within acceptable levels.

C-CORE, long involved with the study of ice scour processes, conducted these analyses on behalf of Millennium for the Lake Erie crossing (C-CORE 1999a). Their design process was similar to the one used for the Northstar project (C-CORE 1999b). Nevertheless, detailed technical objections were raised during the FERC and USACE public comment periods, primarily by National Fuel Gas Supply Corporation (National Fuel 1999a, 1999b, 2000).

ERDC researchers examined the Millennium project materials, C-CORE's design for ice scour protection, and the technical objections raised. Summarized below are the main issues we sought to resolve during this review.

### *2.2.1 Prediction of 100-year ice scour depth*

Two sets of information are required to predict the 100-year scour depth along a proposed route: the distribution of scour depths and the rate that scours occur. Repetitive geophysical mapping of the proposed route is the preferred method to obtain this information. However, it can take many years to build a sufficiently large database of scours for locations such as Lake Erie, where scour rates are low ( $< 1$  scour/km/yr). Other environmental data and knowledge of ice scour

processes can be used to supplement route-specific data.

C-CORE's original design for ice scour protection (C-CORE 1999a) relied primarily on data from a single geophysical survey along the Millennium route, conducted by Canadian Seabed Research (CSR) in 1998. They compiled a distribution of scour depths using both newly formed and infilled scours. They estimated scour rates by classifying each scour according to its qualitative appearance and then estimating the average age for each class. This reliance on a single survey raised several concerns:

- Only six measured scours were newly formed, and no allowance was made for sediment infilling of older scours.
- Episodic scour formation and infill processes in Lake Erie suggest a need for a longer sample interval.
- Individual scours much deeper than those measured by the 1998 survey have been observed near the proposed route.
- Qualitative age classes introduce large uncertainties in the calculated scour rates.
- The small total number of measured scour depths introduces uncertainty in the estimated depth distribution.
- Lack of in-service experience with pipelines exposed to ice scour suggests a need for conservatism in the analyses.

C-CORE countered that the depth distribution of existing scours can approximate that for new scours (Lewis 1977, Lanam et al. 1986), that it is difficult to assign recurrence rates to individual deep scours, that they calibrated their scour-rate method using other surveys from Lake Erie, and that compounding conservatism can make the effective design return interval much longer than the 100-year code requirement. Nevertheless, we agreed that additional analysis of ice scour data from Lake Erie, selected sensitivity analyses, allowance for conservatism in the design method, and comparisons with benchmark calculations could increase confidence in the predicted 100-year scour depth.

C-CORE and members of the ERDC review team conducted this additional work collaboratively. Chapters 3–5 describe this work and the recommended changes to the 100-year scour depths used to design the pipeline.

### *2.2.2 Prediction of soil deformation and pipeline response*

Researchers at C-CORE were the first to discover that significant soil movement occurred beneath scouring ice keels and that this movement could deliver large loads on marine pipelines buried below the scour

depth (Woodworth-Lynas et al. 1996). They led a joint-industry research project termed PRISE (Pressure Ridge Ice Scour Experiment) to quantify this effect. PRISE consists of centrifuge modeling, finite-element analyses, and field studies. Its results are proprietary to the participants, although relevant results were made available to the ERDC review team (C-CORE 1998).

The issues raised during public comment and the ERDC review focused primarily on the assumptions made to model the soil–pipeline interaction. These included use of two-dimensional (rather than three-dimensional) modeling, ignoring the presence of a partially filled trench, and details regarding the choice of soil-stiffness parameters. C-CORE addressed these issues through a question–answer process, and no additional analyses were needed. Chapter 6 describes the soil–pipeline interaction modeling and the ERDC review of it.

### 2.3 Sediment sampling and deposition/ turbidity modeling

Millennium proposes to excavate the pipeline trench using mechanical jetting and suctioning and lateral displacement of the excavated sediments (FERC 1999). BEAK International, Inc. (BII), on behalf of Millennium, conducted sediment sampling along the proposed route and analyses of the samples for contamination. They also modeled the deposition of the displaced sediments and the extent and concentration

of the turbidity plume. Technical concerns over details of this work were raised during public comment.

Lake Erie sediments are known to contain heavy metal and organic contaminants. Concerns about the adequacy of the sampling program included locations of samples, depths of sampling, and the use of mercury as an indicator contaminant. Concerns about sediment deposition and the turbidity plume focused on specifics of the modeling method used to predict these effects and consequently on the accuracy of the predictions. Researchers at the ERDC Environmental Laboratory (EL) assessed these concerns, sought clarification, and assessed Millennium’s answers. In most cases, no additional analyses were required. Chapters 8 and 9 summarize their findings.

## 3.0 SUMMARY OF ICE SCOUR DATA

### 3.1 Zone definitions and focus of data review

C-CORE (1999a) divided the Millennium pipeline Lake Erie crossing into zones A through J based on water depth, soil type, and exposure to scouring ice features. The pipeline routing was changed slightly in late 1998, which necessitated a change in the zone definitions. Figures 3.1 and 3.2 show the revised zones, and Table 3.1 provides the water depth ranges and extents of each zone. Note that the beginning of zone F coincides with the U.S.–Canada international boundary.

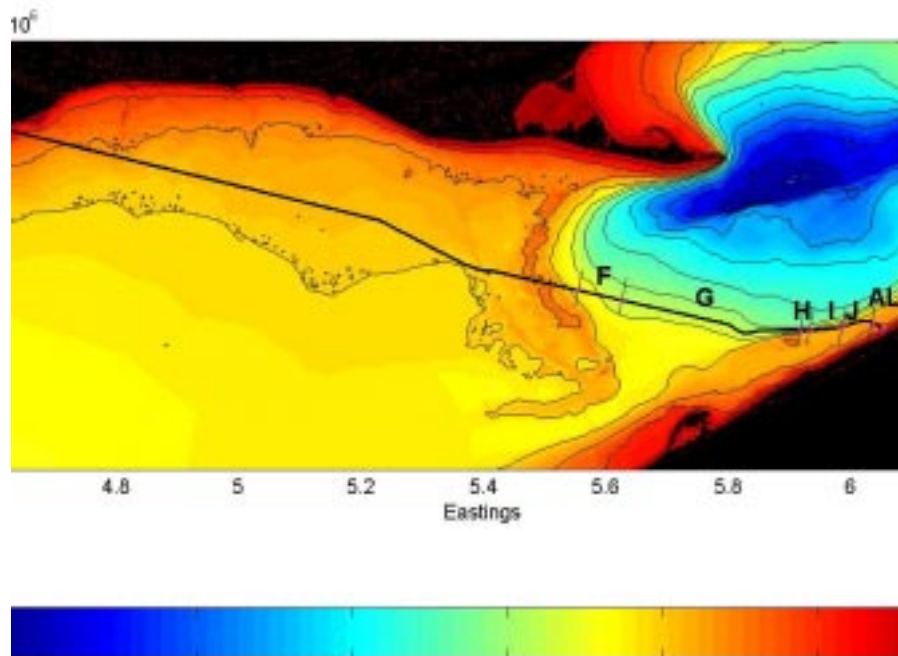

Figure 3.1. Millennium pipeline zones in U.S. waters.

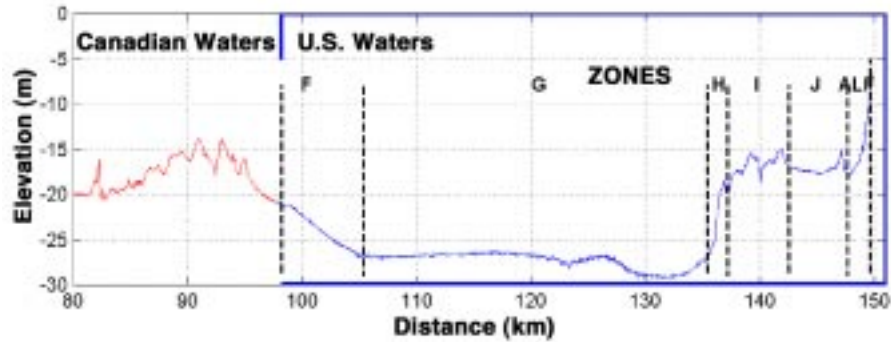

Figure 3.2. Cross section of Millennium pipeline route showing revised zone definitions.

C-CORE (1999a) presented a comprehensive review of ice scour data for Lake Erie. Here we focus on new information processed since that report was issued and re-interpretations of the original data. Also discussed are deep individual scour features in Lake Erie to clear up misinformation from previous reports. This chapter describes the Lake Erie ice scour data; Chapter 5 presents the analyses used to determine 100-year scour depths along the pipeline route.

### 3.2 Ice scour depth distribution

#### 3.2.1 Use of new scours

The depth distribution of the scour record changes as new ones are formed and existing ones are infilled by sediment transport. Infilling removes shallow scours from the record and reduces the depth of others. New scours replenish the record.

If the scour and infill rates are constant over time and the depth distribution is exponential, the scour depth

distribution will remain constant (Lewis 1977, Lanan et al. 1986). However, field evidence from the Beaufort Sea suggests that the depth distribution for new scours is slightly deeper than that for all scours present on the seabed. For the U.S. Beaufort Sea, Weeks et al. (1983) found that new scours were 20% deeper, on average, than existing scours in 15-m-deep water. For the Canadian Beaufort Sea, Nessim and Hong (1992) found new scours to be 10–30% deeper than existing scours in water depths of 12–23 m. Since ice scours occur routinely in the Beaufort Sea, this trend is most likely due to decreasing infill rate as scours become shallower (Fredsoe 1979, Weeks et al. 1985), causing shallow scours to persist in the record.

In Lake Erie, ice scour and infill processes are episodic, and the observed scour record at any time may not reflect the distribution of scours as they were made on the lakebed. On this basis, we focused on the depth distribution of new scours. As before (C-CORE 1999a),

Table 3.1. Original and revised Millennium pipeline zones in U.S. waters. Original zones were defined in C-CORE (1999a).

Pipeline zone	Original definitions		Revised definitions		Undrained shear strength (kPa)
	Distance from Canadian landfall (km)	Start–end water depth range (m)	Distance from Canadian landfall (km)	Start–end water depth range (m)	
F	99–107	22.3–28.2	98.0–105.0	21.0–26.7	25
G	107–136	28.2–27.1	105.0–135.1	26.7–27.4	25
H	136–139	27.1–17.6	135.1–136.8	27.4–18.4	100
I	139–146	17.6–18.3	136.8–142.2	18.4–16.4	100
J	146–150	18.3–5.0	142.2–147.3	16.4–17.1	100
ALF	150–DDA		147.3–149.3 (DDA)	17.1–8.3	Rock

ALF—American Landfall

DDA—End of Directionally Drilled Pipe from American Landfall

new scours are defined as those for which all details of the original scour mounds and scour base are visible on the survey records. They exhibit little or no evidence of infilling. Consequently the measured depth approximates the depth of the original incision.

### 3.2.2 Sampling the scour depth distribution

We have also concentrated on populations of scours from comprehensive lakebed surveys, ones conducted using sidescan sonar and a sub-bottom profiler to document scour width, depth, and appearance. Typically comprehensive surveys consist of a series of linear surveys along individual scours, along the route proposed for a pipeline or cable crossing, or within an area to construct a mosaic. The data from such surveys are, insofar as possible, unbiased with respect to soil, ice, and bathymetric conditions that govern the ice scour process.

Isolated scours found on an opportunity basis should be considered carefully since they represent biased samples. For example, a few individual scours with depths greater than about 1 m have been measured in Lake Erie. While these are useful for comparison with predicted extreme values, in general they should not be lumped with data from comprehensive surveys. It is difficult to establish the frequency of occurrence of individual deep scours, and many shallow scours should accompany each deep one if they derive from the same population.

For frequent processes such as winds and waves, it is sufficient to consider only the largest events for engineering design. Often only annual maxima are used to predict 100-year events. However, the ice scour process is generally less frequent, and historical records are shorter. Consequently even in the Beaufort Sea all scours in a region have been used to characterize the depth distribution for design purposes (INTEC 1998a,

1998b). This approach is particularly appropriate for Lake Erie, where scour rates are lower and no long-term studies exist.

Twenty-five scour marks with measurable depth were identified in the 1998 CSR route survey. Since only a handful of these can be considered “new” scours, we examined data from other lakebed surveys conducted by a variety of agencies for different purposes. The context of these surveys, and of individual deep scours found outside of comprehensive surveys, bear on their use in predicting the 100-year ice scour depth. The relevant data sources for analysis of design scour depth along the proposed Millennium pipeline route are listed in Table 3.2. Details of these data are found in Sections 3.2.3, 3.2.4, and 3.2.5.

### 3.2.3 Millennium route surveys

*Scour depth from 1997 route survey.* All of the ice scours surveyed by Racal in 1997 were resurveyed by Canadian Seabed Research in 1998 (C-CORE 1999a). Since the latter survey yielded higher-quality data and no new scours, we have not used the 1997 data.

*Scour depth from 1998 route survey.* The 1998 CSR survey documents scour depths along the pipeline route, in the U.S. and Canadian landfall areas, and along the Clear Creek Esker (C-CORE 1999a). Data from this survey were reinterpreted, and only scours classified as new were retained. For scours that were surveyed several times along their tracks, we included in the database only the greatest measured depth for each scour.

Two scours were observed as having significant and measurable infilling. These were assumed to have original depths equal to the measured depth plus the infilled amount. These two scours were therefore reclassified as “new.” Table 3.3 lists the scour depth

**Table 3.2. Expanded ice scour data set relevant to Millennium pipeline route.**

<i>Source</i>	<i>Year</i>	<i>Location</i>	<i>Details</i>
Ontario Hydro	1981	Coho (U.S. shore)	Interpreted by Ontario Hydro (C-CORE 1999a, Table 2.5)
Ontario Hydro	1982	Coho (U.S. shore)	Interpreted by Ontario Hydro (C-CORE 1999a, Table 2.5)
Ohio	1995	U.S. shore	Interpreted by Jim Shearer (this document, Table 3.4)
CSR	1998	Pipeline Route	Interpreted by Jim Shearer (C-CORE 1999a, Appendix D)

**Table 3.3. Summary of “new” scour depth data for Lake Erie.**

<i>Source</i>	<i>Water depth (m)</i>	<i>Scour depth (m)</i>
	17	0.2
	12.4	0.4
Ontario Hydro 1981	24.7	0.2
Coho Area Survey	21.9	0.2
	13.8	0.2
	17.2	0.4
Ontario Hydro 1982	21.9	0.1
Coho Area Survey	23.7	0.5
Ohio Geological Survey 1995	14–16	See Table 3.4
	18.3	0.5
	20.25	0.7
	19.5	0.6
Canadian Seabed Research 1998	8.6	0.3
Pipeline Route Survey	8.4	0.2
	8.4	0.2
	9.8	0.1
	9.8	0.5

and the water depth of the resulting eight new scours from the 1998 CSR survey.

### 3.2.4 Ontario Hydro surveys

Ontario Hydro conducted a series of linear and area surveys in the early 1980s to support the design of a proposed submarine transmission cable (Grass 1984). Most of the work focused on the U.S. and Canadian near-shore zones (Coho and Nanticoke regions, respectively).

*Coho region.* We included in our analyses data from Ontario Hydro surveys near Coho on the U.S. shore. This region is reasonably close to the pipeline route, and it has similar soil, bathymetric, and ice-exposure conditions to zones H, I, and J of the pipeline route.

Eight ice scours ranging from 0.1 to 0.5 m were identified in the Coho area (Table 3.3). These represent all scours with measurable depth identified by Ontario Hydro in this area during 1981 and 1982 surveys (C-CORE 1999a). The original sidescan data have not been reanalyzed. Grass (1984) described how the scours observed each year were not present the previous year. Thus, we classified all eight as new scours.

*Nanticoke region.* Ontario Hydro data from the Nanticoke region have been excluded from our design analysis. The scours occurred in much softer soil than found along the Millennium pipeline route, and they appear to represent a different population from the scours recorded by the other Lake Erie surveys.

Many of the ice scours surveyed by Ontario Hydro at Nanticoke were found in cohesive soils with undrained shear strengths of less than 12.5 kPa. Scours along the pipeline route have been observed only in sand and in cohesive soils with shear strengths in excess of 50 kPa. Insufficient data exist to transform the scour depths from Nanticoke to the stronger soils along the proposed Millennium route.

Fourteen Nanticoke scours were identified in sand/gravel deposits. In principle, these scours could be included in the design analysis for the Millennium route. However, shear strengths of 25 kPa were associated with two of the fourteen scours. This strength is inconsistent with sand and gravel deposits, and more detailed geotechnical data are not available. Also, the six Nanticoke scours in sand/gravel with measurable depths occur in water deeper than 23 m, and their average scour depth is 0.61 m. This is much deeper than the average depths of the other Lake Erie data sets, and indeed it is deeper than would be expected in the U.S. Beaufort Sea for similar water depths (Weeks et al. 1983). The occurrence of such deep scours in deep water suggests an exposure to ice scour conditions very different from those along the Millennium route. For these reasons, we have not included any of the Nanticoke scours in the pipeline design analyses.

### 3.2.5 Other surveys in U.S. waters

*Overview.* C-CORE (1999a) summarized the known lakebed surveys conducted in U.S. waters. Of these the most relevant were conducted by the U.S. Geological



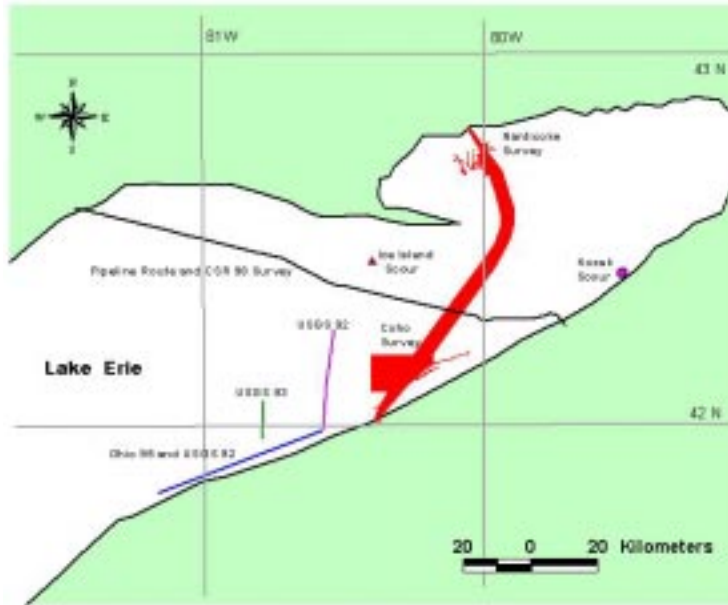

**Figure 3.3. Survey routes for U.S. Geological Survey cruises 1991–1993.**

Survey in 1992 and 1993 and by the Ohio Geological Survey in 1995. These surveys are the most easterly ones illustrated in Figure 3.3 and included sidescan sonar and sub-bottom profiler data.

Mr. Jim Shearer, a consultant with extensive experience analyzing ice scour surveys, examined the original records from these three surveys. He identified 50 km of survey lines from 1995 that overlapped with lines from 1992 and identified numerous new scours by comparing the two records. Their similar fresh appearance suggested that these scours all derived from the winter or early spring of 1994, when severe ice conditions and strong winds were reported (Assel et al. 1996).

Scour marks were also identified in the 1992 and 1993 surveys. However, these showed signs of

significant infilling and have not been included in the pipeline design analyses.

*Ohio Geological Survey 1995.* A detailed examination was undertaken of the sonar survey conducted by the Ohio Geological Survey division in 1995. The 50 km that overlapped with 1992 consisted of two survey lines parallel to the U.S. shore. These lines, in water depths of 14–16 m, run from the Ohio–Pennsylvania border to a point about 50 km to the southwest.

In total, Shearer identified 96 new scours. A breakdown of their depth distribution is listed in Table 3.4. The greatest scour depth measured was 0.6 m. Although the two survey lines were only 1 km apart, it is not believed that more than 10% are scours common to both lines because the observed scours were primarily

**Table 3.4. Scour depth distribution from 1995 Ohio Geological Survey data.**

Scour depth range (m)		Number of scours		
		Line		Total
Minimum	Maximum	L-29	L-28	
0.00	0.10	15	15	30
0.10	0.15	11	12	23
0.15	0.25	14	8	22
0.25	0.35	9	1	10
0.35	0.45	6	1	7
0.45	0.55	3		3
0.55	0.65		1	1
Total		58	38	96

parallel and sub-parallel to shore.

Lakebed conditions have been assessed from the sub-bottom profiler over the 50-km lines. Thirty percent of the lines are over an eroded glacial lacustrine surface, similar to that seen in a water depth of about 19 m along the Millennium pipeline route west of the Clear Creek Esker. The other 70% of the line is over cohesive fines, probably comprising a sand and silty clay mixture with shear strength of about 20 kPa and above.

### 3.3 Ice scour rates

#### 3.3.1 Absence of ice scour marks in pipeline zones F, G, and H

For its original pipeline analysis, C-CORE (1999a) estimated the frequency or rate of ice scour along the pipeline route based primarily on the CSR 1998 survey results. Specifically Shearer classified each observed scour according to its physical appearance on the survey records, and then C-CORE researchers estimated an average age for each of the resulting four appearance classes. Because no scours were observed in the deepwater section and its approaches (pipeline zones G, F, and H, respectively), C-CORE assigned nominal rates of 0.01 scours/km/yr for Zones F and G and 0.10 scours/km/yr for Zone H.

These assigned scour rates were reconsidered during the ERDC review. Water depths range from 21.0 to 26.7 m in zone F, exceed 26.7 m in zone G, and range from 27.4 to 18.4 m in zone H. In zones F and G, the lake bottom sediments are composed entirely of soft silty clays to a depth of 5 m or more. The soil strengths measured along the route ranged from less than 5 kPa to around 50 kPa. Zone H (eastern flank) possesses a more competent and harder bottom.

Only trawler marks and associated patches of shells can be observed in the sidescan and sub-bottom profile data for zones F and G. There is no evidence of ice scour marks.

According to Shearer, sonar images of the silty clay sediments would reveal the effects of scouring as linear shadows or reflections differing from the natural background reflectivity. Even a scour infilled well beyond its original depth would still exhibit a ghost image.

Pipeline zones F and G are in a sediment transport and depositional environment. Shearer believes that any ice scour marks made over the last 50–100 years would be visible on the sonar records. His only caveat to this is the poor survey conditions (resulting in poor data quality) for the eastern half of zone G. Nevertheless, it is still believed that sufficient data exist to conclude that no scouring has taken place during this time.

The absence of evidence of scouring in zones F and G is believed to be a result of the obstruction by the

Clear Creek Esker and the Norfolk Moraine (Long Point–Erie Ridge). These features rise to water depths of 14–16 m, and may limit ice keels entering zones F and G from the west to depths of about 20 m (allowing for some upslope/downslope scouring). The formation of pressure ridges on Lake Erie appears to occur primarily along near-shore shear zones or bathymetric features such as the Norfolk Moraine. Movement of these ridges into deeper water would necessarily limit their ability to scour as they reach hydrostatic equilibrium. Scours near Nanticoke have occurred in water depths greater than 23 m, but these appear to reflect exposure to a different ice scour regime.

The situation in zone H is different, since this is an area where traction transport has occurred and a more energetic bottom depositional environment is present. In this area the residence time for a scour could be significantly less than in areas of suspension deposition. Also, the Coho 1981–82 surveys and the USGS 1993 surveys recorded scours in bathymetric and exposure conditions similar to zone H. Consequently the absence of observed scours in the CSR 1998 survey for zone H does not necessarily mean the absence of scouring. C-CORE (1999a) assigned a rate of 0.1 scours/km/yr for zone H, essentially the rate determined for scours observed in the adjacent zone I. We see no reason to alter this rate.

The following conclusions can be made from the re-examination of the 1998 CSR route survey records:

- The assigned rate of 0.01 scours/km/yr in zones F and G is justified and is certainly conservative if the scour residence time is 50 years or greater.
- The assigned rate of 0.1 scours/km/yr for zone H is reasonable. Reducing it would require further evidence, since scours have been observed in similar bathymetric and exposure conditions.

### 3.4 Isolated deep scours

#### 3.4.1 Ontario Hydro ice island scour

The 1.5-m-deep “ice island” scour observed by Ontario Hydro in 1982 is a potential concern because of its proximity to the pipeline. This scour was observed on the Norfolk Moraine at the location shown in Figure 3.4. The water depth of the scour mark was 16–19 m, and this location is potentially exposed to ice keels moving from deeper water onto this shelf. The scour is believed to have been caused by the “ice island” pressure ridge documented extensively on video by Jim Grass of Ontario Hydro in February 1982 (Grass 1984). Direct measurements of soil strength are not available at this location. Sediment was lifted to the surface by ice blocks during the formation of the ice island, indicating the presence of fine seabed sediments.

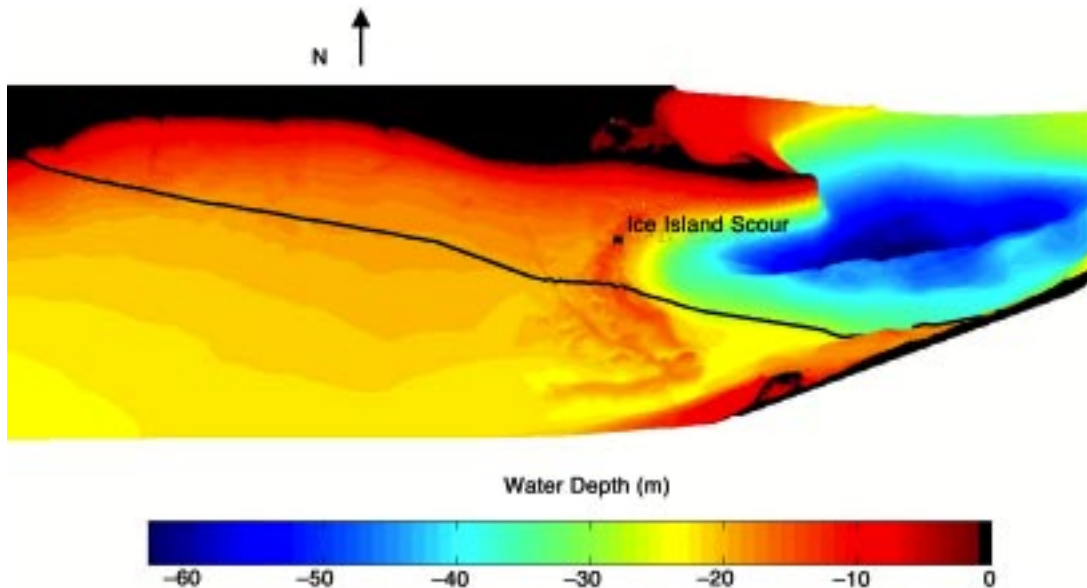

Figure 3.4. Lakebed bathymetry showing pipeline route and approximate location of “ice island” scour.

#### 3.4.2 Scours observed by Canadian Geological Survey

Steve Blasco of the Canadian Geological Survey observed an ice scour mark in the summer of 1998 in the vicinity of the ice island scour. A significant amount of infill material was present in the scour mark. Because of differences in the position of these two observations, there is some uncertainty as to whether they are in fact the same scour feature. If they are different scours, they could reflect the ridge-building effectiveness of the Norfolk Moraine. As mentioned, however, it appears that these ridges do not scour into the adjacent U.S. deep-water zone F.

#### 3.4.3 Scour observed by Kozak

On behalf of National Fuel, McQuest (1998) documented a 1-m-deep scour, 8–10 m wide in 21-m-deep water about 20 km from the pipeline route near the U.S. shore. Mr. Gary Kozak of Klein Associates, Inc., a manufacturer of side-scan sonar, observed this scour in 1977. He obtained sonar and photographic records of the scour and determined its depth during two dives. McQuest (1998) prepared a map showing the location of this and other scours in Lake Erie; National Fuel filed the map with FERC (National Fuel 1999b). It is reasonable to assume that such a scour could occur in pipeline zones H, I, or J. Its recurrence interval is unknown, although Assel et al. (1996) list the winter of 1977 as the fifth coldest for the Great Lakes in 215 years of record.

#### 3.4.4 1.7-m scour near Port Burwell

The MPC Preliminary Design Report—36" Gas Pipeline for TCPL Page 9-3 (MPC 1997) states

*“Pembina warned of an observed ice scour area in central part of Lake Erie, along Long Point to the southeast side of Port Burwell. In the area of active ice scour, furrows have been observed up to 5.6 feet (1.7 m) deep. Ice scour has not been seen at water depths greater than 80 feet (25 m). Gas well damage due to ice keel was reported in 1979 in 2 areas located about 22 miles (35 km) south of Port Burwell.”*

The first two sentences convey the impression that the 1.7-m-deep scour is located southeast of Port Burwell and consequently quite near the pipeline route. However, further investigation has confirmed that these sentences refer to different sections of the lake.

The first sentence refers to the area of ice scour damage in 1977 adjacent to the proposed pipeline route, as shown in Figure 2.14 of C-CORE (1999a). The second sentence refers to the area off Nanticoke. MPC (now Pegasus) confirmed the location of the 1.7-m scour in their email to C-CORE of March 16, 2000 (see Appendix B). It derived from the 1980–82 surveys off Nanticoke by Ontario Hydro.

Section 4.8 of Fitchko (1999) rephrased the MPC (1997) information to read

*“Based on this (Talisman) experience, an ice scour area has been delineated in the central part of the lake along Long Point to the southeast side of Port Burwell (MPC 1997). In this area of active ice scour, furrows have been observed up to 1.7 m deep (5.6 ft) in up to 25 m (80 ft) water depth.”*

These two statements propagated the misunderstanding about the location of the 1.7-m scour. Jerry

Fitchko of BEAK verbally confirmed to C-CORE that the 1.7-m scour relates to the area off Nanticoke.

The Pembina gas pipeline system in Lake Erie was acquired recently by Talisman Energy. Appendix C is a letter from Talisman Energy to TransCanada Transmission dated 22 September 1999. This letter covered the chart of known locations of damage to the Talisman system. The letter states that

*“All visible scouring we have experienced has been limited to a maximum depth of 2 feet into the lake bottom....”*

This statement confirms that Pembina did not observe a 1.7-m-deep scour within its system, including areas close to the Millennium pipeline route.

**3.4.5 Purported 3.6-m-deep scour**

In Ontario Hydro internal report 80463, Mr. Jim Grass referenced a possible 3.6-m-deep scour southeast of Port Burwell (i.e., in the vicinity of the proposed Millennium pipeline route). National Fuel (1999b) has suggested, and Grass has implied, that this observation derives from discussions with Pembina personnel. However, correspondence with Talisman (Appendix C) indicates that this is not the case, as they have observed no scours deeper than 0.6 m.

Grass presented his understanding of the 3.6-m-deep

scour in an email to Peter Patient of TransCanada on March 30, 2000 (see Appendix D). He confirms that this area was not surveyed by Ontario Hydro, and the scour was not included in their database for the cable design. He has no evidence now to support the existence of a 3.6-m-deep scour. By way of explanation, Grass notes that Ontario Hydro report 80463 was written at a time when little was known about ice scours in Lake Erie, and any information or anecdotes were important for developing an understanding of the process.

**4.0 TALISMAN EVIDENCE**

**4.1 Overview of Talisman pipeline network**

Hundreds of gas wells and an extensive gathering network of pipelines have existed in Lake Erie for decades. This system, currently operated by Talisman Energy, is located exclusively in Canadian waters both east and west of the proposed Millennium pipeline. The Talisman pipeline network currently in operation is illustrated in Figure 4.1.

There are nearly 700 wellheads in their system, of which about 650 are still in use. Only 30–40 of these have been lowered below the lakebed; the remainder stick up about 2 m above the lake floor. The “buried” wellheads are either in prime trawling grounds (and follow regulatory requirements) or in areas of known

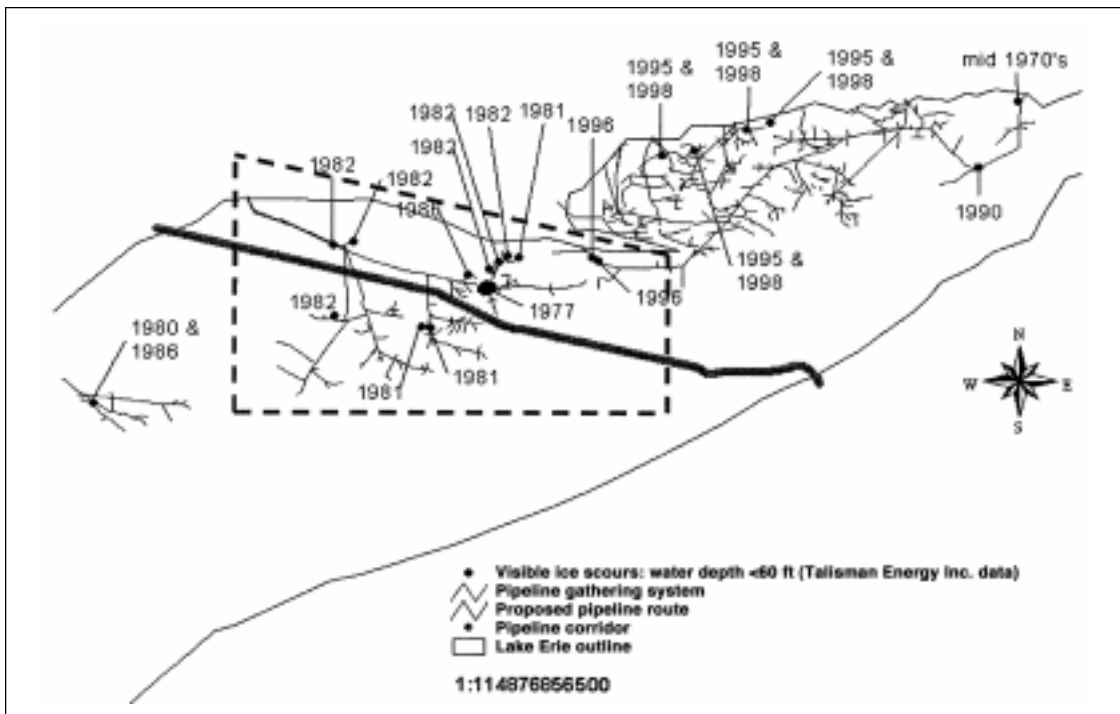

**Figure 4.1. Millennium pipeline route, Talisman gas pipelines on the seabed, and recorded dates of pipeline damage. The inset shows the region considered in this analysis.**

ice scour. The total length of the Talisman pipeline system, including the branches, is about 1675 km.

Talisman has identified damage to its network caused by ice scour events. This record and the network's proximity make it a good case study to assess the methods used to predict ice scour frequency and 100-year depth for the Millennium pipeline.

#### 4.2 Ice damage events

Ice has damaged wellheads and pipelines at a number of locations over the years, as indicated in Figure 4.1 (Talisman Energy letter to TransCanada Transmission, 22 Sep 99, Appendix C). Damage has also occurred due to other factors, but the data presented here are related exclusively to ice.

Talisman notes the following:

- Observed scours were limited to depths of 0.6 m and water depths of 18 m.
- In all but one case, ice scour caused damage to equipment placed on or just below the lakebed.
- In a 1999 installation, a sour-gas transmission line was buried 1.2 m deep out to 10-m water depth as a precaution against ice.
- Apart from this 1999 installation, all of the other lines were installed directly onto the lakebed.

As shown in Figure 4.1, twenty-five damage events have occurred over a period of approximately 25 years over the whole network. These damaged pipelines and wellheads were repaired and brought back into operation shortly after being damaged by ice scour. The network is assumed to be at least 25 years old; the actual installation dates of the system are unknown.

#### 4.3 Damage frequency for entire Talisman network

Because of the many branches in the Talisman pipeline network, individual ice scour events could cross more than one branch. It is therefore appropriate to consider only a subset of this network when assessing the length of pipelines exposed to ice scour. Excluding branches of less than 5 km and branches parallel to the main lines, the Talisman network has a length of approximately 950 km. The parallel branches are up to 200 m from the main lines and have a total length of about 50 km.

Table 4.1 shows the distribution of pipeline lengths in different water depths for both the Talisman network and the proposed Millennium pipeline. Twenty percent of the Talisman network is in water depths greater than 30 m and is unlikely to experience ice scour. Thus, the total length exposed to ice scour should be reduced proportionally to 760 km (= 80% × 950 km). Otherwise, the distributions for the gas pipeline network and the Millennium route are similar, suggesting that a comparison between ice scours for the gas gathering network and the Millennium pipeline is appropriate. An annual rate of scour damage of 0.0013 per kilometer (or 25 events/25 years/760 km) can therefore be inferred.

#### 4.4 Damage frequency for Talisman subset near the Millennium route

A subset of the Talisman network lies quite near the Canadian section of the proposed Millennium pipeline route (Figure 4.1). This portion, between Port Stanley to the west and the tip of Long Point to the east, offers the best long-term record available on scour conditions

**Table 4.1. Water depth distribution.**

Water depth range (m)	Percent of length for Talisman network		Percent of length for proposed Millennium pipeline	
	Overall network	Vicinity of Millennium pipeline	Overall	Excluding zone G
0-10	8	2	3	4
10-20	48	80	64	85
20-30	24	14	33	11
30-40	8	1	—	—
>40	12	3	—	—

along the Millennium route. The Talisman subset has a length of 309 km, excluding branches less than 5 km in length and 42 km of parallel lines. The proportion of the length is given as a function of water depth in Table 4.1.

Zone G of the Millennium pipeline (107–136 km from Canadian landfall) is nearly 30 m deep and beyond the water depth for scour damage. If this zone is excluded, the depth distribution for the Talisman network is nearly identical to that for the proposed pipeline (Table 4.1). On this basis, it is appropriate to compare damage rates for the Talisman network to scour rates over the Millennium pipeline.

From Figure 4.1, thirteen damage events occurred over a period of approximately 25 years in the Talisman subset near the proposed pipeline. An annual damage frequency of 0.0017 per kilometer (13 events/25 years/309 km) can be inferred from these data.

#### **4.5 Inference for scour frequency along Millennium pipeline route**

Some of the ice scours crossing the Talisman network may not have caused serious damage. Consequently the above damage rates may underestimate the rate for all scours crossing over the network. However, this effect should be small. It is unlikely that many of the scours would have crossed the network of small-diameter pipelines without causing significant damage.

Another consideration is the orientation of scours with respect to the pipeline. Many scour marks are observed to be nearly parallel to the bathymetric contours. For exact comparison of Talisman and Millennium scour frequencies, the orientation of the Talisman network segments and the Millennium pipeline sections with respect to observed scour marks should be considered. This correction has not been applied to either data set; its effect should be less than 30%.

We therefore conclude that the damage rate inferred from the Talisman subset (0.0017 scours/km/yr) approximates the scour rate along the Canadian section of the Millennium route over the past 25 years. Based on the 1998 CSR survey, C-CORE (1999a) estimated the scour rates in the Canadian zones (A–E) to be 0.10–0.44 scours/km/yr. These estimates are conservative by an order of magnitude compared to the Talisman subset.

Although directly applicable to the Canadian section, this comparison also provides confidence in the scour rates estimated by C-CORE (1999a) for the U.S. section of the Millennium route. It suggests that C-CORE conservatively underestimated the scour ages from the 1998 CSR data. On this basis, there is no reason to believe that annual scour frequencies should be any higher than originally recommended by C-CORE (1999a).

#### **4.6 Inference for scour depth distribution**

Talisman reported that the deepest scour they have observed was 0.6 m. If this was one of the 13 damage events considered in Section 4.4, it provides an independent estimate of the scour depth distribution along the proposed Millennium route. This information is used in Section 5.3.4 to assess the implications of the Talisman data on the design scour depths for the Millennium pipeline.

### **5.0 DESIGN SCOUR DEPTH**

#### **5.1 Strategy**

##### *5.1.1 Differences from C-CORE Report 98-C34*

C-CORE Report 98-34 (C-CORE 1999a) describes the data and methods used to determine the 100-year or design scour depths for each zone of the proposed Millennium pipeline. As noted in Section 2.2, the method used parallels the method used to design the Northstar oil pipeline for ice scour resistance. Nevertheless, to increase confidence in the design, C-CORE and ERDC researchers agreed to incorporate additional data on Lake Erie scours and to conduct additional analyses. While the basic approach is identical with C-CORE (1999a), the following changes have been made:

- Only new scours have been considered.
- Scour data from other comprehensive surveys near the Millennium route have been included.
- Scour rates were substantiated with data from the Talisman gas-gathering network (Chapter 4).
- An exponential distribution with a cutoff depth has been used to account for under-sampled shallow scours.
- Several benchmarks have been used to validate the predicted design scour depth.

##### *5.1.2 Overview of new scour data for Lake Erie*

As noted in Chapter 3, we chose to include only “new” scours in the design analyses because these best represent the population of scours as they are created. We also selected only data from comprehensive surveys near the Millennium route and exposed to similar ice scour conditions. This yielded the following data sources (Table 3.1): the 1981 and 1982 Ontario Hydro Coho surveys, the 1995 USGS Ohio survey, and the 1998 CSR Millennium pipeline route survey.

Tables 3.2 and 3.3 present the scour depth data used here. They represent the most comprehensive data available that are appropriate to the design of the Millennium pipeline Lake Erie crossing.

### 5.1.3 Scour depth distributions

Figure 5.1 shows the distribution of scour depths for the 1995 USGS Ohio survey. Of the 96 measured new scours, the maximum depth is 0.6 m. We used Weibull plotting position (rank of the point in descending order divided by the total number of points plus one) to estimate the probability of exceedence for measured scour depths. The exceedence plot is a semi-log scale, so that exponentially distributed scour depths would plot as a straight line. The mean depth for the Ohio data is 0.17 m, and the standard deviation is 0.13 m. Since the standard deviation is less than the mean, an exponential fit would tend to predict slightly greater probabilities of occurrence for larger scour depths than the original data would indicate.

Figure 5.2 shows the scour depths from 1981–82 Coho and the 1998 CSR surveys combined. The mean scour depth is 0.33 m, and the standard deviation is 0.19 m. Of the 16 data points, the maximum scour depth is 0.7 m (an infilled scour on the pipeline route for which the original depth could be estimated). The histogram for scour depth indicates that the data are poorly sampled. Note that the original 25 scour depths measured along the Millennium route fit an exponential

distribution (C-CORE 1999a). The poor fit here probably reflects the small sample sizes from the two surveys (new scours only).

Figure 5.3 shows the depth distribution of the three surveys combined (112 points). The mean scour depth is 0.20 m, the standard deviation is 0.15 m, and the maximum scour depth is 0.7 m. The exceedence data show a fairly linear trend below 0.05 m, with a slight decrease for depths greater than 0.5 m. The combined data set reflects the relatively good exponential fit of the large 1995 Ohio data set.

### 5.1.4 Probability distribution for scour depth

There is no unique probability distribution characterizing the ice scour depths. The exponential distribution with a cutoff depth provides a reasonable fit to scour depths in the Alaskan Beaufort Sea (Weeks et al. 1983, Wheeler and Wang 1985, INTEC 1998b). It appears to slightly overpredict the occurrence of deep scours, making it a conservative choice for predicting design scour depths. The cutoff depth relates to the resolution of the survey system and corrects the slope of the distribution for undersampling of shallow scours. Weibull and gamma distributions yielded better fits to

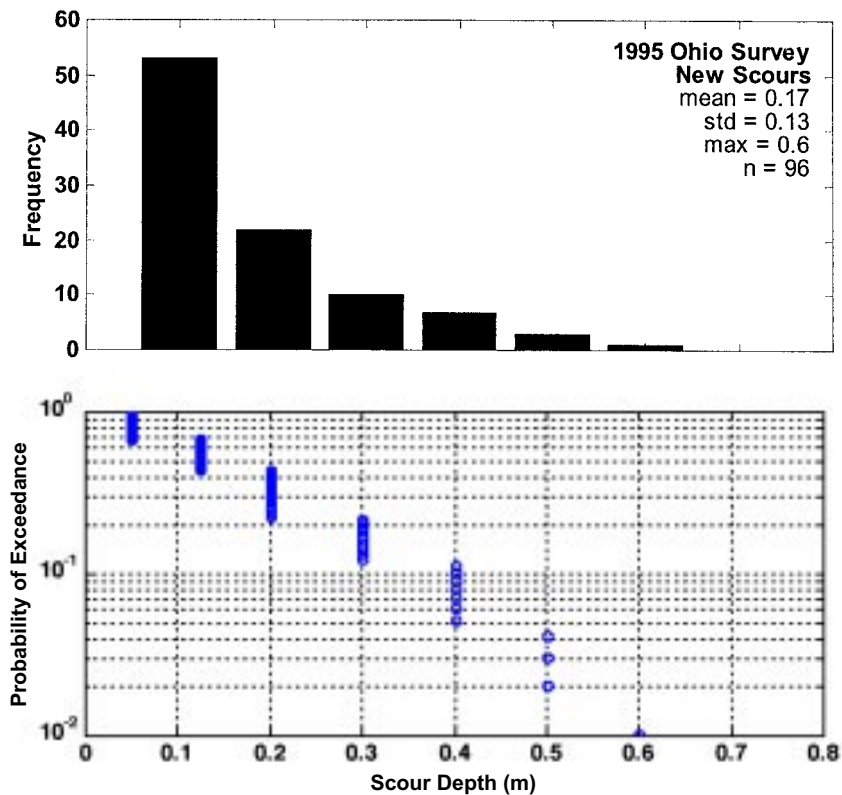

Figure 5.1. Depth distribution of “new” scours compiled from 1995 Ohio Geological Survey data.

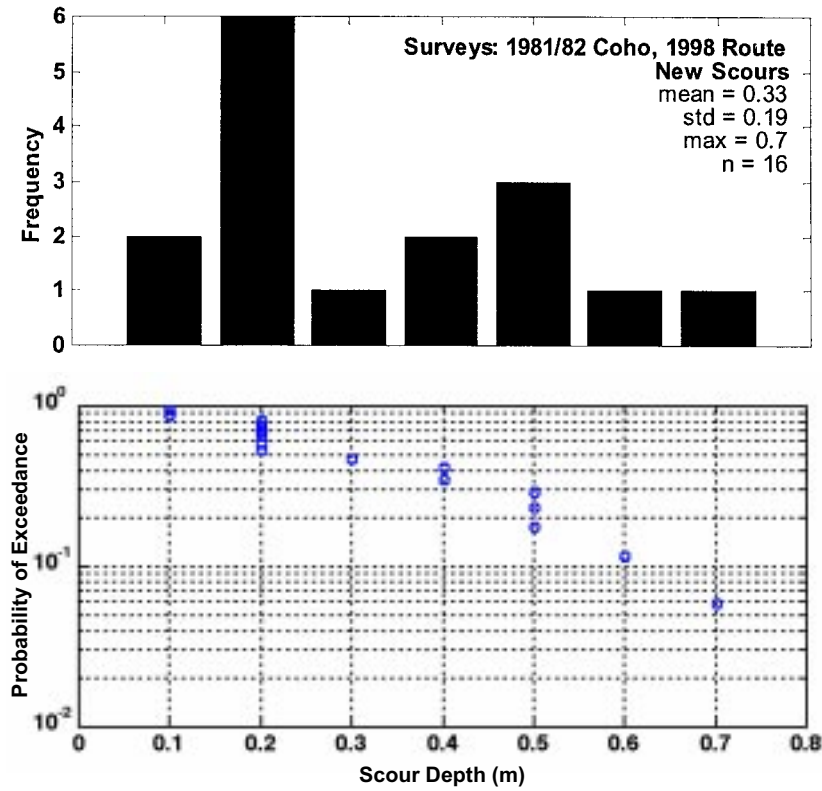

Figure 5.2. Depth distribution of “new” scours compiled from Ontario Hydro 1981 and 1982 surveys (Coho) and from Canadian Seabed Research 1998 route survey.

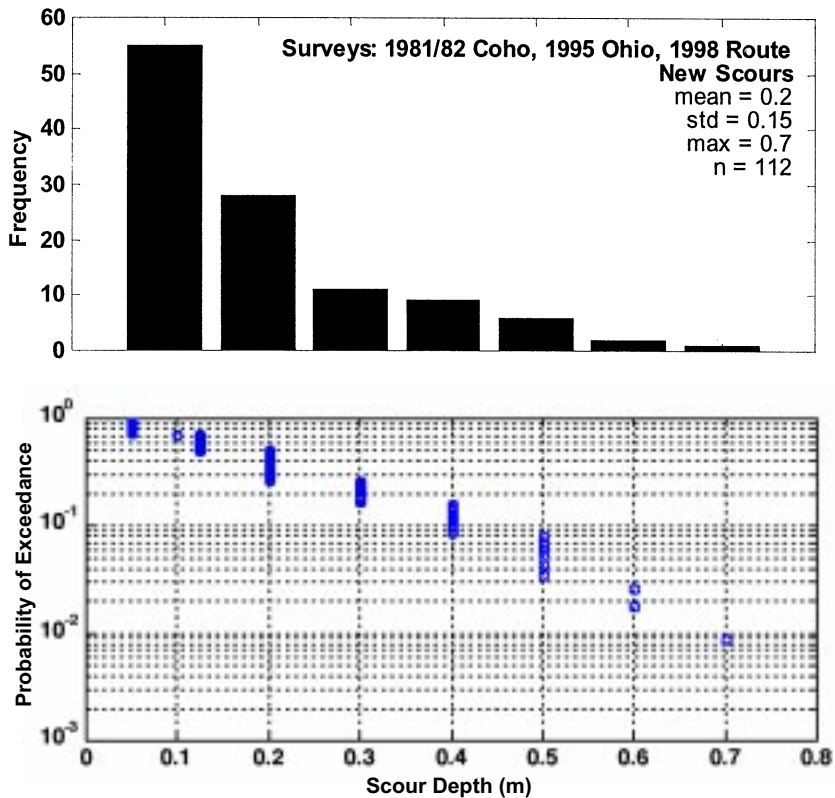

Figure 5.3. Depth distribution of “new” scours compiled from the Ontario Hydro 1981 and 1982 surveys (Coho), from the Ohio 1995 survey, and from the Canadian Seabed Research 1998 route survey.



scour depths in the Canadian Beaufort Sea (Nessim and Hong 1992). Again, the exponential distribution overpredicted deep scours.

Based on Figure 5.1, the exponential distribution appears to provide an adequate representation of scour depths for the 1995 Ohio data. From Figure 5.2, it appears that shallow scours are underrepresented in the 1981–82 Coho and 1998 CSR surveys. The combined distribution, which is dominated by the 1995 Ohio survey data, is well represented using an exponential distribution.

While an exponential distribution has been selected for the present data set, we do not endorse this distribution for all circumstances. Characteristics of the bathymetry, soil properties, ice strength, and environmental driving forces may influence the form of the distribution. The ability of ice keels to penetrate marine sediments is an interplay between these characteristics, and scour depth should truncate when soil resistance exceeds the ice strength or driving forces. Despite much effort, however, no suitable theory or data exist to define the truncation depth.

We prefer to use an exponential distribution here because it fits the data reasonably well, it has been used successfully elsewhere for the same process, and it tends to be conservative.

The exponential probability density function with a cutoff  $c$  can be represented by

$$p(x) = \lambda \exp[-\lambda (x - c)] \quad (5.1)$$

where  $x$  is scour depth and  $\lambda$  is the distribution parameter. The “best estimator” for the exponential parameter is

$$\lambda = 1/(\text{mean depth} - c). \quad (5.2)$$

For the exponential distribution with a cutoff, the probability of exceedence for scour depth can be expressed as

$$E(x) = \exp[-\lambda (x - c)]. \quad (5.3)$$

The vertical resolution of the sub-bottom profilers is approximately 0.1 m. A review of Figures 5.1, 5.2, and 5.3 indicates that  $c = 0.05$  m minimizes the influence of underrepresented shallow scours on the slope of the distribution. Note that scours shallower than  $c$  are omitted from the data set for subsequent analyses.

## 5.2 Design scour depth

### 5.2.1 Two ways to combine data sets

The 1995 Ohio data may be from a single breakup episode during the 1994 ice season (Section 3.2.5). Although the survey lines were 50 km long, they

represent a narrow bathymetric range between 14 and 16 m. On the other hand, the lines cover a range of soil types, and the scour marks were probably made by a range of ice keel features and driving forces. The 1995 data appear to be well sampled and are well represented by the exponential distribution. Note that 79 scours from the 1995 Ohio data set are deeper than 0.05 m; these average 0.204 m.

Because of the temporal and spatial limitations of the 1995 Ohio data, we considered two methods for combining them with the Coho and Millennium survey data. The first approach is to consider each measured scour as having equal weight. The second is to give equal weight to each data set.

If individual scours from the three data sets are weighted equally, the total number of scours deeper than 0.05 m is 95, and their average depth is 0.226 m. The exponential distribution with a cutoff depth of 0.05 m is shown in Figure 5.4. The exponential parameter is  $5.68 \text{ m}^{-1}$  and will be denoted  $\lambda_A$ . This parameter is heavily weighted by the distribution of scour depths from the Ohio 1995 survey.

If the Ohio and Coho–Millennium surveys are considered equally representative, the two distributions can be combined by averaging the two mean depths. The net mean is therefore  $(0.204 \text{ m} + 0.332 \text{ m}) / 2 = 0.268 \text{ m}$ . The corresponding exponential parameter (bearing in mind the 0.05-m cutoff) is  $4.59 \text{ m}^{-1}$  and will be denoted  $\lambda_B$ . This distribution probably yields conservative values for the design scour depth since the Coho and Millennium surveys probably underrepresent shallow scours.

### 5.2.2 100-year scour depths

The design scour depth corresponds to the exceedence probability calculated from the annual risk allocated per km of pipeline divided by the annual scour frequency per km of pipeline (C-CORE 1999a). The exceedence probability for scour depth  $x_T$  corresponding to a return period  $T$  is

$$E(x_T) = 1 / (TLr) \quad (5.4)$$

where  $L$  is the total length of the pipeline, and  $r$  is the annual scour rate per kilometer of pipeline. Assuming an exponential distribution, the design scour depth for any particular pipeline segment or zone is then

$$x_T = c + \ln(TLr) / \lambda \quad (5.5)$$

in which  $c$  is the cutoff depth and  $\lambda$  is the exponential distribution parameter. In the present calculations, the pipeline length  $L$  is assumed to be 150 km.

The annual scour rates corresponding to the various

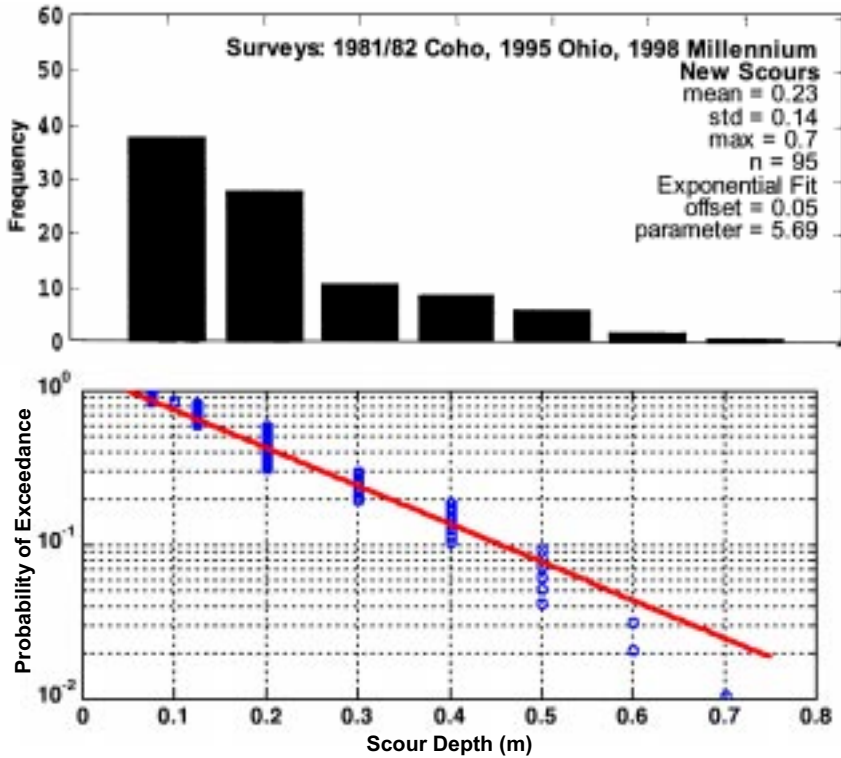

Figure 5.4. Exponential fit to depth distribution of “new” scours compiled from Ontario Hydro 1981 and 1982 surveys (Coho), from Ohio Geological Survey 1995 survey, and from Canadian Seabed Research 1998 route survey.

pipeline sections are listed in Table 5.1 for U.S. waters. C-CORE (1999a) based the rates for zones I and J on estimated residence times for scours recorded by the 1998 CSR survey. Scour rates for zones where no scours were observed (F, G, and H) were assigned values based on other considerations (Section 3.3). Additional review (Section 3.3) and analysis of damage data for the Talisman network (Section 4.5) showed that the rates in Table 5.1 are reasonable or conservative.

For equally weighted scours, the exponential parameter is  $\lambda_A = 5.68 \text{ m}^{-1}$ . The design scour depth

corresponding to a 100-year return period is 0.93 m for sections F and G, and 1.34 m for zones H, I, and J. As stated in the last section, this approach tends to bias the results in favor of the 1995 Ohio data, which form the largest portion of the data set.

For equally weighted data sets (1995 Ohio survey and 1981–82 Coho/1998 CSR surveys), the exponential parameter is  $\lambda_B = 4.59 \text{ m}^{-1}$ . The design scour depth corresponding to a 100-year return period is 1.14 m for zones F and G, and 1.64 m for zones H, I, and J. As noted, this approach is probably conservative.

**Table 5.1. Millennium pipeline zones in U.S. waters defined in C-CORE (1999a).**

Pipeline zone	Distance from Canadian landfall (km)	Start–end depth range (m)	Undrained shear strength (kPa)	Annual scour frequency (/km)	100-year ice scour depth (m)
F	99–107	22.3–28.2	25	0.01	0.8*
G	107–136	28.2–27.1	25	0.01	0.8*
H	136–139	27.1–17.6	100	0.10	1.2
I	139–146	17.6–18.3	100	0.11	1.2
J	146–150	18.3–5.0	100	0.08	1.2
ALF	150–DDA		Rock		

ALF: American Landfall

DDA: End of Directionally Drilled Pipe from American Landfall

\* Assigned values based on need to protect pipeline from anchors and fishing gear. Ice scour does not control trench depths for zones F and G.

It is tempting to select the more conservative of the two results for design. However, use of an exponential distribution already introduces conservatism in predicted design scour depths (Section 5.1.4). Furthermore, codes for marine pipelines (ASME 1995, CSA 1999) allow for the random nature of environmental loads by specifying return periods much longer than the service life of the pipeline. These codes specify designing for expected 100-year events, without specifying reliability levels or safety factors. We interpret them as specifying a “best estimate” (i.e., 50% reliable estimate) of the 100-year event.

Our “best estimate” of the 100-year scour depth in zones H, I, and J is the average of the results from the two methods described above:  $x_{100} = (1.34 + 1.64) = 1.49 \text{ m} = 1.5 \text{ m}$ . Note that all scours used to determine the depth distribution and rates derive from surveys along the Millennium route or in areas of similar ice scour conditions to zones H–J.

Zones F and G must be handled differently. Neither the 1997 Racial survey nor the higher-resolution 1998 CSR survey revealed any evidence of ice scour in zones F and G. Consequently C-CORE (1999a) arbitrarily assigned a rate of 0.01 scours/km/yr for these zones, essentially to protect the pipeline from dragging anchors and fishing gear. With their original scour-depth distribution (exponential with no cutoff,  $l = 6.2 \text{ m}^{-1}$ ), they calculated  $x_{100} = 0.8 \text{ m}$ . This depth plus allowance for sub-scour deformation (0.1 m) seemed more than adequate to protect the pipeline from these effects (C-CORE 1999a).

The 1998 CSR survey should have revealed evidence of scour over at least the past 50 years (Section 3.3.1). Using equation (5.5), we may calculate the scour rate

inferred by choosing  $x_{100} = 0.8 \text{ m}$  and check it for consistency. For  $\lambda_A = 5.68 \text{ m}^{-1}$ ,  $r \sim 0.005 \text{ scours/km/yr}$ , and for  $\lambda_B = 4.59 \text{ m}^{-1}$ ,  $r \sim 0.002 \text{ scours/km/yr}$ . Zones F and G are about 37 km long. Thus, if the lakebed preserves a 50-year scour record, the survey would have revealed evidence of about 4–9 scours. Furthermore, the inferred rates equal or exceed the scour rate determined from the Talisman damage data (Chapter 4).

We see no reason to alter C-CORE’s (1999a) design scour depth for zones F and G. Ice scour does not control pipeline trench depth in zones F and G, and  $x_{100} = 0.8 \text{ m}$  provides a reasonable level of protection even if it did.

Table 5.2 summarizes the revised design scour depths for the U.S. section of the proposed Millennium pipeline route.

### 5.2.3 U.S. landfall

The landfall area adjacent to the U.S. shore (denoted ALF in C-CORE 1999a) consists primarily of bedrock. Ice scour is not an issue in this material.

In the U.S. landfall area, it is recommended that the pipe crown be placed flush with the lakebed allowing for pipe curvature over changes in the slope of the trench. To ensure this, the trench should be at least 1064 mm deep, accounting for the 914-mm outside diameter of the pipe and 150 mm to account for the 75-mm concrete cover.

## 5.3 Sensitivity and benchmark analyses

### 5.3.1 Sensitivity to exponential cutoff value

The value selected for the cutoff in the exponential scour-depth distribution,  $c = 0.05 \text{ m}$ , fits the data well (Figures 5.1–5.4). It is also consistent with a sub-bottom profiler resolution of about 0.1 m. We examined the

**Table 5.2. Revised 10-year and 100-year scour depths for Millennium pipeline zones in U.S. waters. Note adjustments to the zone locations and depth ranges.**

Pipeline zone	Distance from Canadian landfall (km)	Start–end water depth range (m)	Annual scour frequency (/km)	10-year scour depth (m)	100-year scour depth (m)
F	98.0–105.0	21.0–26.7	0.01	0.3–0.6	0.8*
G	105.0–135.1	26.7–27.4	0.01	0.3–0.6	0.8*
H	135.1–136.8	27.4–18.4	0.10	1.0	1.5
I	136.8–142.2	18.4–16.4	0.11	1.0	1.5
J	142.2–147.3	16.4–17.1	0.08	1.0	1.5
ALF	147.3–149.3 (DDA)	17.1–8.3			

ALF—American Landfall

DDA—End of Directionally Drilled Pipe from American Landfall

\* Assigned values based on need to protect pipeline from anchors and fishing gear. Ice scour does not control trench depths for zones F and G.

sensitivity of the 100-year scour depths predicted for zones H–J to variations in  $c$ . Using the methods in Section 5.2.2, we would expect  $x_{100} = 1.64$  m for  $c = 0$ , and  $x_{100} = 1.31$  for  $c = 0.10$  m. Thus, the expected 100-year scour depths are not highly sensitive to  $c$ , and their average agrees with our best estimate of  $x_{100} = 1.5$  m.

### 5.3.2 Predicted 10-year scour depths

The record of observed scours in Lake Erie is much less than 100 years. Thus, it is instructive to predict 10-year scour depths for the different pipeline zones. For zones H, I, and J,  $x_{10} = 1.0$  m based on the methods in Section 5.2.2. This is reasonable considering that the deepest scour in the data set analyzed is 0.7 m (Section 5.1.3).

The expected 10-year scour depth in zones F and G depends on the rate assigned:  $x_{10} \sim 0.3$  m for  $r = 0.002$  scours/km/yr, and  $x_{10} \sim 0.6$  m for  $r = 0.01$  scours/km/yr. The 1998 CSR survey would certainly have detected scours this deep had they been present. It appears that even the lower scour rate is conservative.

### 5.3.3 Isolated deep scours

The scour data set used for design included only scour depths from comprehensive surveys (Section 3.2). Nevertheless, isolated deep scours have been observed in Lake Erie (Section 3.4). In particular, the Kozak scour measured 1 m deep, and the ice island scour measured 1.5 m deep. Based on our best estimates for zones H, I, and J, these scours correspond to 10-year and 100-year events, respectively.

Inclusion of these isolated deep scours does not affect the best estimates for the 100-year scour depths. The design database would include 97 (equally weighted) scours deeper than 0.05 m. The resulting mean value of 0.247 m yields  $\lambda_A = 5.09 \text{ m}^{-1}$  and  $x_{100} = 1.49$  m (for  $r = 0.1$  scours/km/yr). Although this is higher than the value based on the 95 equally weighted scours from comprehensive surveys ( $x_{100} = 1.34$  m), the effect is exaggerated. Many small scours should accompany each deep scour if they derive from the same process as the other data sets. Indeed, the method using equally weighted data sets cannot be used with isolated scours for this reason. Consequently the expected 100-year scour depth including the two deep scours agrees with our best estimate,  $x_{100} = 1.5$  m.

### 5.3.4 Talisman data

The damage records for the Talisman gas network represent the longest record available on ice scour in Lake Erie (Chapter 4). Thirteen breakages due to ice scour occurred in the network subset near the Millennium route over a 25-year period. If the deepest scour observed by Talisman (0.6 m) was one of these

13, its exceedance probability based on Weibull plotting position would be  $E(0.6 \text{ m}) \sim 1 - 13/14 = 0.0714$ . Assuming an exponential depth distribution with  $c = 0.05$  m, equation 5.3 yields  $\lambda = 4.8 \text{ m}^{-1}$ . This value of  $\lambda$  agrees well with those from the design data set (Section 5.2.2) and would predict  $x_{100} = 1.6$  m for  $r = 0.1$  scours/km/yr (zones H–J). Within the uncertainty of the Talisman calculation, this agrees with our best estimate ( $x_{100} = 1.5$  m).

The Talisman benchmark directly applies to Canadian zones of the Millennium pipeline. The inferred scour rate,  $\sim 0.002$  scours/km/yr, is conservative by an order of magnitude compared with the estimates for the pipeline zones A–E (Section 4.5). If the scour rate is approximately constant, we would expect  $4 \times 13 = 52$  scours in 100 years based on the Talisman data. Consequently equation 5.5 would suggest  $x_{100} = 0.05 + \ln(52 + 1)/4.8 = 0.88 \text{ m} = 0.9$  m. This is significantly less than C-CORE's (1999a) design depths for the Canadian section (1.2–1.4 m).

C-CORE used the same method to estimate scour rates in U.S. zones H, I, and J (0.08–0.11). The Talisman data suggest these rates could also be conservative, although ice exposure conditions differ. Nevertheless, our best estimate  $x_{100} = 1.5$  m provides sufficient margin for uncertainty in scour rates in these zones.

### 5.3.5 1998 route data adjusted for infill effect

Data from the Beaufort Sea indicate that new scours may be about 20% deeper on average than existing scours, although they approximate the same distribution (Section 3.2.1). C-CORE (1999a) originally calculated design scour depths for the Millennium route based on 25 scour depths (new and infilled) measured along the route by the 1998 CSR survey. The average depth was 0.166 m. The Beaufort Sea data suggest that we may approximate the average depth of the new scours that formed this distribution by applying a 20% correction for infilling,  $0.166 \times 1.2 \sim 0.20$  m.

C-CORE found that an exponential distribution with  $c = 0$  fit the measured depths reasonably well. Using the adjusted mean depth, the distribution parameter would be  $\lambda = 1/0.20 = 5.0 \text{ m}^{-1}$ . Thus, in pipeline zones H–J ( $r = 0.1$  scours/km/yr) the C-CORE's originally used distribution adjusted for infilling would yield  $x_{100} = 1.5$  m (equation 5.5). This is coincidental agreement with our best estimate, but it does suggest that the infill effect in Lake Erie is also small on average.

### 5.3.6 100-year scour depth for 1994-like episodes

The new scours recorded by the USGS 1995 Ohio survey may have derived from a single breakup episode in 1994 (Section 3.2.5). These scours occurred in water depth, soil, and ice exposure conditions similar to

pipeline zone J. We may estimate the 100-year scour depth for 1994-like episodes and compare it to the best-estimate value for zone J.

The 1995 Ohio data set consists of 79 scours deeper than 0.05 m found along 50 km of survey lines, or 1.6 scours/km-line. These scours were primarily parallel to shore and intersected the survey lines at shallow angles. Assuming an average intersection angle of 15 degrees, the scour density across a pipeline perpendicular to the average scour direction would be approximately six scours/km.

The recurrence interval for 1994-like events is more difficult to estimate. Fortunately the expected 100-year scour depth is insensitive to recurrence interval.

Assel et al. (1996) found that the winter temperatures measured around Lake Erie rank 1994 about the 18th coldest of 97 years of record. This suggests a return period for ice conditions of about five years. However, Assel et al. (1996) report that gale force winds on 14 March 1994 caused considerable ice ridging. That is, ice and high winds probably caused the ice scour episode, and their lower joint probability would suggest a recurrence interval longer than five years. Also, the 1998 CSR survey found no high-density 1994-like scours. Based on their appearance class, C-CORE (1999a) estimated the scours observed to be about 7.5 years old.

Our best estimate for the recurrence interval for 1994-like events is about 10 years. The resulting scour rate over a pipeline perpendicular to the scour direction would be  $r \sim 6$  scours/km/10 years = 0.6 scours/km/yr. The scour depth distribution for the 1995 Ohio data (Fig. 5.1) yields  $\lambda = 6.48 \text{ m}^{-1}$  for  $c = 0.05 \text{ m}$ . The expected 100-yr scour depth from equation 5.5 is  $x_{100} = 1.45 \text{ m} = 1.5 \text{ m}$ . Varying the estimated recurrence rate for 1994-like episodes from five to 10 years varies the expected 100-year scour depth from 1.4 to 1.6 m. The result is also not sensitive to other variables affecting  $r$ , and the exponential distribution tends to be conservative for deep scours. Thus, our best estimate of  $x_{100} = 1.5 \text{ m}$  for zone J is reasonable.

#### 5.4 Summary of revisions to design scour depth

There are two significant differences in the data used to obtain the present results compared with original C-CORE analysis. First, only “new” scour features, with no significant infilling, have been considered. Second, the data set used for design analyses has been expanded to include depth measurements for approximately 100 scours from the 1995 USGS Ohio survey and from the 1981–82 Ontario Hydro Coho surveys.

We used two methods to combine the data and selected our “best estimate” of the 100-year scour depth

as the average of the resulting two values. Where scour controls the design depth (pipeline zones H–J), our best estimate  $x_{100} = 1.5 \text{ m}$  compares well with several benchmark calculations. As a result of this work, there is significantly more confidence in the present design scour depths for the Millennium pipeline.

## 6.0 PIPE RESPONSE AND TRENCH DEPTH

### 6.1 Introduction

The response of the Millennium pipeline to ice scour (gouge) events was analyzed by a finite-element numerical model. The ice scour events are based on the 100-year design scour depths presented in Section 5.2. The trench depths for the pipeline were assessed so that resulting longitudinal pipe strains did not exceed tensile or compressive design limits.

Section 5.2 of C-CORE (1999a) describes in detail the stress-based and strain-based designs applied to the Millennium pipeline. The design limits were based on code recommendations (CSA 1999) and discussions with Millennium partner Trans-Canada Pipelines. The design tensile strain limit of 2.5% generally governs the required trench depth. It is important to note that these limits are for safe operation. It is expected that the pipe failure strain to rupture will be about 3.75%, representing a factor of safety of about 1.5.

This chapter briefly describes the model used, the results of the ERDC review of the model, and the design trench depths based on revised 100-year scour depths. Also included is a brief description of conservatism in the analyses.

### 6.2 Pipe-response model overview

The response of the Millennium pipeline subject to ice scour events was analyzed by a finite-element numerical model. This model is described in Section 5 and Appendix B of C-CORE (1999a) and is presented in Kenny et al. (2000). This numerical model comprised three components: soil/pipeline interaction, ice scour/soil relationships, and finite-element formulation. This section briefly describes these components.

The soil/pipeline interaction model is based on ASCE (1984) guidelines for the seismic design of oil and gas pipeline systems. The idealized structural model is illustrated in Figure 6.1. The continuum soil response is approximated by a series of discrete springs. The stiffness terms,  $t-s$  and  $p-y$ , represent the axial and horizontal soil response components, respectively. The ultimate or yield conditions were based on the ASCE (1984) guidelines.

The importance of sub-scour deformations was realized through the Pressure Ridge Ice Scour

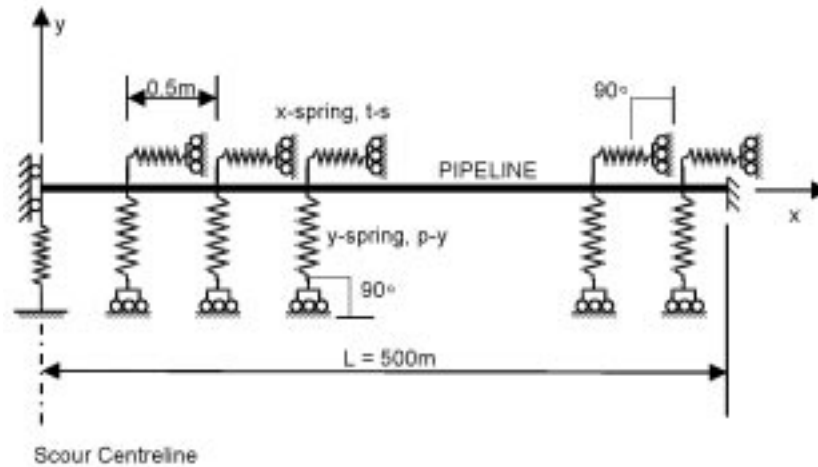

**Figure 6.1. Schematic of finite-element model and geometric boundary condition.**

Experiment (PRISE) investigations. Schematic illustrations of sub-scour deformation profiles are illustrated in Figures 6.2 and 6.3i. Details of the empirical relationships defining the sub-scour displacement field are presented in Woodworth-Lynas et al. (1996). The response functions were derived from analysis of centrifuge modeling tests conducted under PRISE. The longitudinal distribution (Fig. 6.2) is characterized by a bounded, peak central displacement with a cosine tail distribution. The free-field vertical profile under point B in Figure 6.3i exhibits an exponential decay with increasing depth.

In PRISE, an engineering model was developed to assess the influence of ice gouge events on buried

marine pipelines. This engineering model was used to design the Northstar pipeline against ice scour (C-CORE 1999b). An improved version of this model was used in the design of the pipeline for the Lake Erie crossing. Pipeline response to subgouge soil deformations is modeled by fully nonlinear finite-element analysis using two-dimensional pipe elements coupled to discrete soil springs. The effects of internal pressure, ice bearing pressure, and ice scour width and depth on the longitudinal strain response of a buried pipeline are all considered.

The finite-element analyses were conducted using ABAQUS/Standard. The soil/pipeline interaction model (Fig. 6.1) was discretized by two-dimensional beam

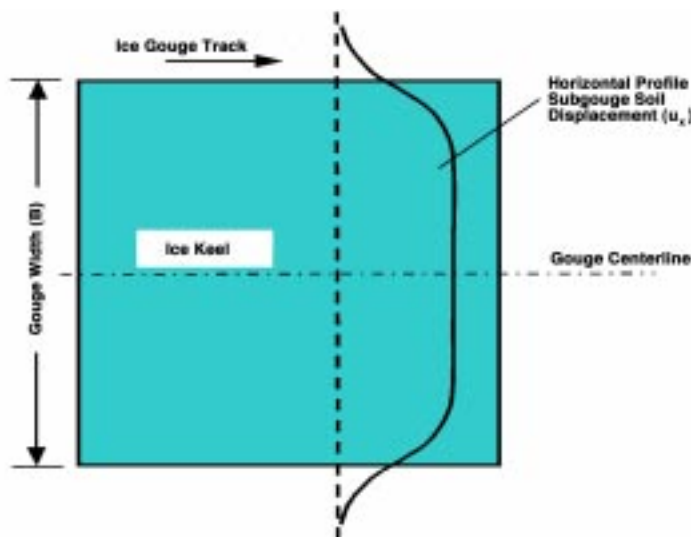

**Figure 6.2. Plan view of the horizontal profile sub-scour soil displacement.**

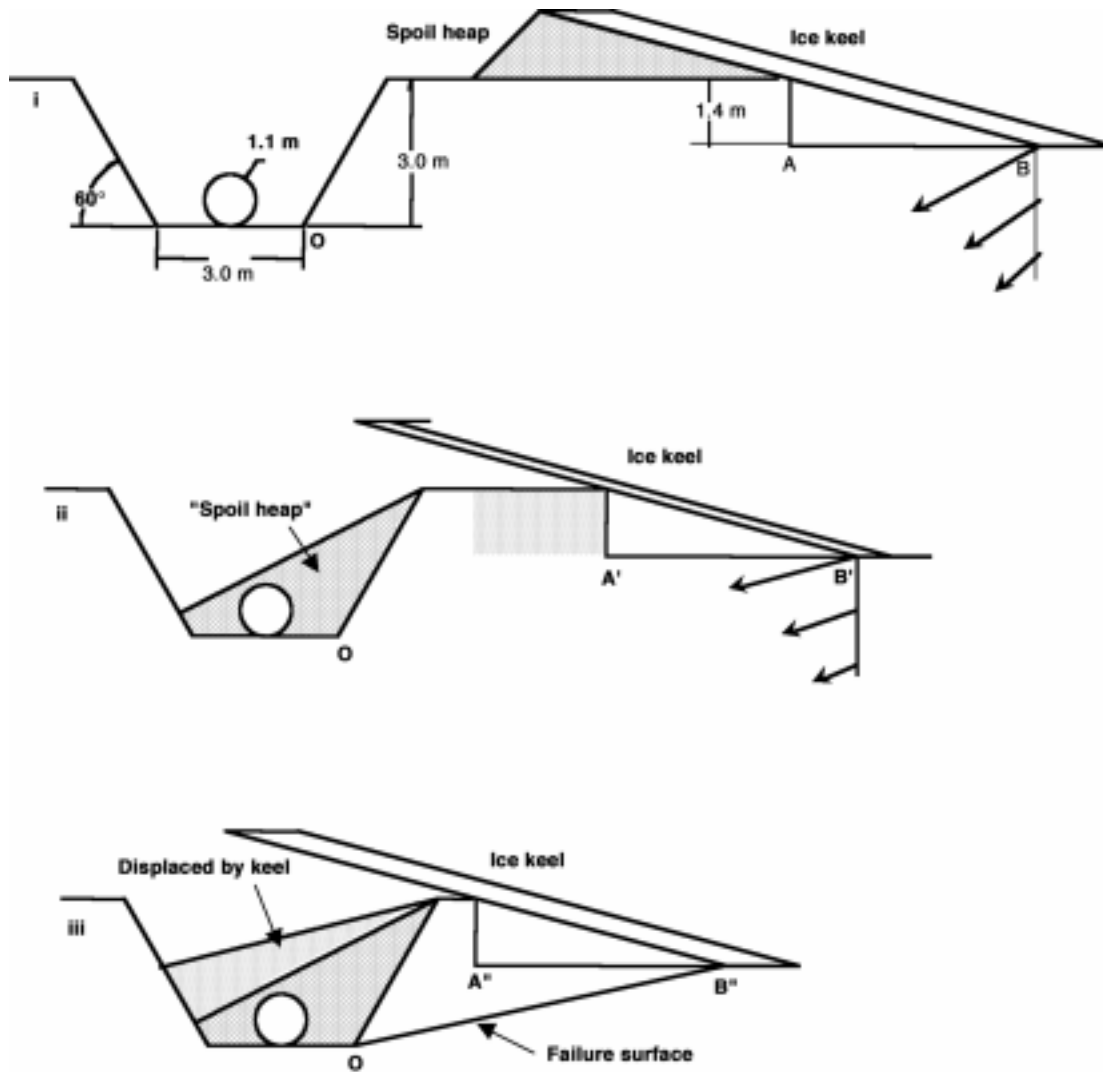

Figure 6.3. Progression of scouring ice keel-trench interaction.

elements (PIPE22) and one-dimensional spring elements (SPRINGA). The finite-element model accounted for longitudinal symmetry and the geometric boundary conditions as illustrated in Figure 6.1.

The beam element is based on Timoshenko beam theory assuming linear elastic, transverse shear behavior. Three degrees of freedom per node are active, and the behavior is defined by quadratic shape functions. Two additional variables related to hoop strain account for internal pressurization. The constitutive relationship for the pipe steel was defined by a piece-wise linear fit to the Ramberg-Osgood formulation,  $\epsilon = (\sigma/E)[1 + \alpha(\sigma/\sigma_y)^{n-1}]$ , where  $\epsilon$  is the strain,  $\sigma$  is the applied stress,  $E$  is the elastic modulus,  $\alpha$  is the plastic yield offset,  $\sigma_y$  is the yield stress, and  $n$  is the hardening exponent. The default Simpson's rule (five-point) integration scheme was adopted.

The soil response is defined by nonlinear spring elements for the axial and horizontal soil deformation. An idealized bilinear, elastic, perfectly plastic load-deformation relationship was considered. For a given pipeline trench depth, the sub-scour deformation was determined for a particular scour geometry and soil profile at the neutral axis (i.e., springline) of the buried pipeline. The resultant displacement field was imposed on the horizontal spring elements as an initial displacement boundary condition.

The finite-element solution accounted for fully nonlinear behavior (i.e., geometric and material) with large displacement and strain capabilities. The time step was subdivided into 50 increments with Newton's method employed for equilibrium iterations. To obtain a convergent solution, the longitudinal axis of the spring elements remained orthogonal to the reference datum

(Fig. 6.1). This is due to the zero transverse stiffness of the element (SPRINGA). The post-processing included beam element stress–strain data (output at the integration points), bending moments (averaged at the nodes), and nodal displacements. The data output for the spring elements included centroidal force and displacement.

### 6.3 ERDC/CRREL review

Researchers at CRREL conducted the ERDC review of the pipe response. Using a question–answer format, C-CORE clarified a series of points about the model. The main concerns were the effects of an open (rather than backfilled) trench, the validity of the use of two-dimensional rather than three-dimensional modeling, and the choice of soil stiffness characteristics. All points were resolved satisfactorily, and no revisions to the model were required. Section 6.6 contains the specific CRREL questions, C-CORE answers, and CRREL response to those answers.

### 6.4 Revised trench depth recommendations

The pipeline routing used in C-CORE (1999a) was changed slightly in late 1998. This change necessitated a redefinition of the pipeline zones as shown in Table 6.1.

The pipeline trench depth recommendations were revised as a result of this rezoning and the revised 100-year ice scour design depths presented in Section 5.2. These trench depth recommendations were based on the following considerations and analyses.

Ice scours will not penetrate the outcrop of bedrock at the ALF. The trench depth in the ALF is therefore

sufficient to place the coated pipe crown at the elevation of the lakebed.

No ice scours have been observed in zones F and G. The trench depth in these zones is dictated by other considerations, such as dragging anchors. Nominal ice scour depths of 0.8 and 0.4 m were considered for the 100-year and 10-year ice scour events, respectively. The recommended trench depths in zones F and G were based on models TCPLes3 and TCPLes4 presented in Section 5.6 and Table 5.11 of C-CORE (1999a). Table 5.11 is reproduced in part in Table 6.2 with cross-references to the pipe zones considered and the related steel pipe crown clearances. Models TCPLes1 and TCPLes3 confirmed the strain-based design recommendations for the 100-year events. Models TCPLes2 and TCPLes4 supported these trench depth recommendations by consideration of a stress-based design based on the predicted 10-year scour events.

In zones F and G the 100-year ice scour design depths were the same as those assessed in C-CORE (1999a). In zones H, I, and J the revised 100-year ice scour design depths were increased to 1.5 m from 1.2 m as a result of the EDRC review process. Model Case X was used to confirm the recommended trench depth of 3.4 m in zones H, I, and J. The results of Model Case X are presented in Figures 6.4–6.7. Zone H will have a deep-water transition zone, with the trench depth increasing from 2.0 m at the interface with zone G to 3.4 m at a water depth of 25 m.

The peak tensile ( $\epsilon_t$ ) and compressive ( $\epsilon_c$ ) strains satisfied the design strain limits established in Section 5.2.2 of C-CORE (1999a), except for the peak tensile strain in Canadian zone A as calculated in model

**Table 6.1. Summary of recommendations revised (metric units).**

U.S. zones	Start pos'n (km)	End pos'n (km)	Start-end water depth (m)	Avg soil strength (kPa)	Scours /km/yr	Design scour depth (m)		Trench depth (m)
						1:10 year	1:100 year	
F	98.0	105.0	21.0–26.7	25	0.01	0.4	0.8	2.0
G	105.0	135.1	26.7–27.4	25	0.01	0.4	0.8	2.0
H	135.1	136.8	27.4–18.4	100*	0.10	1.0	1.5	3.4
I	136.8	142.2	18.4–16.4	100*	0.11	1.0	1.5	3.4
J	142.2	147.3	16.4–17.1	100*	0.08	1.0	1.5	3.4
ALF	147.3	149.3 (DDA)	17.1–8.3	Rock				1.1

ALF: American Landfall

DDA: End of Directionally Drilled Pipe from American Landfall

\*Mainly sandy lakebed



**Table 6.2. Models supporting trench depth recommendations.**

Model (#)	Zone	Cu (kPa)	Scour width (m)	Scour depth (m)	Peak $\epsilon_t$ (%)	Peak $\epsilon_c$ (%)	Trench depth (m)	Clearance (m)
Case X	H,I,J	100	14	1.5	2.4	-0.8	3.4	0.8
TCPLes1	A	100	14	1.4	2.6	-0.9	2.9	0.5
TCPLes 2	A	100	14	1.0	1.2	-0.7	3.0	1.0
TCPLes 3	F,G	25	14	0.8	0.45	-0.3	2.0	0.2
TCPLes 4	F,G	25	14	0.4	0.14	-0.1	1.9	0.5

TCPLes1. The calculated axial tensile strain in zone A (2.6%) slightly exceeds the allowable limit of 2.5%. This calculated value will be reduced by the presence of the open trench to within acceptable values.

**6.5 Model conservatism**

The pipe-response model includes two sources of conservatism. First, the model assumes that ice keels transfer loads to the pipe through intact native soil. In fact, the Millennium pipeline will lay in an open trench that will backfill naturally over a period of years. The strength of this backfill material will be significantly less than that of intact native soil. Consequently the loads that this material will transfer from a scouring ice keel to the pipeline, and the resulting pipeline strains, will be less than the model calculates (see response to

question 2 in Section 6.6). Modeling limitations prevented quantifying this effect, but it should be significant.

Second, all design calculations are based on a normal angle of incidence of the ice keel relative to the pipeline (Fig. 6.2). This is a worst-case scenario. Section 5.5 of C-CORE (1999a) reported strains calculated by the pipe-response model for 0-, 30-, and 45-degree incidence angles for a 1-m-deep, 14-m-wide scour. For soil strengths where ice scour governs the design (50–100 kPa), the calculated pipe strains decreased by 20% at 30-degree incidence and 40% at 45-degree incidence. For random scour directions, 45 degrees would be the most likely incidence angle. However, the scour surveys are not sufficiently extensive to determine the average orientation of scours relative to the pipeline orientation.

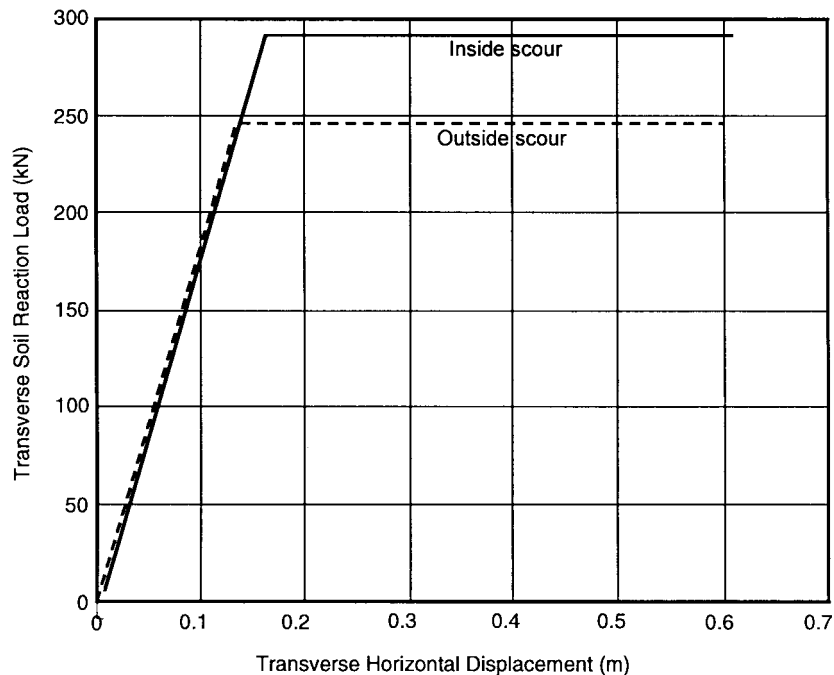

**Figure 6.4. Transverse horizontal load-displacement relationship (symmetric) for Case X.**

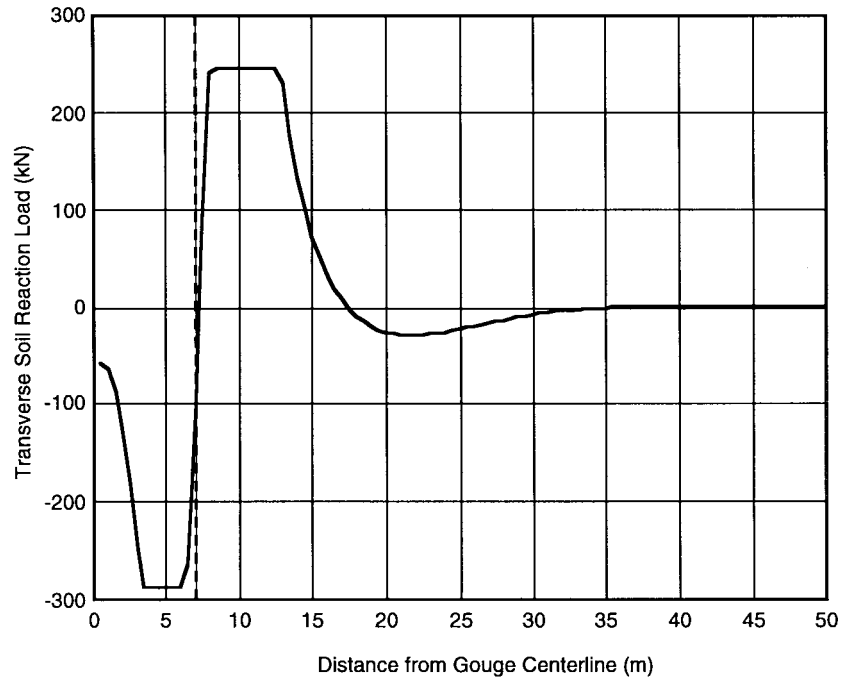

Figure 6.5. Transverse horizontal soil reaction load for Case X.

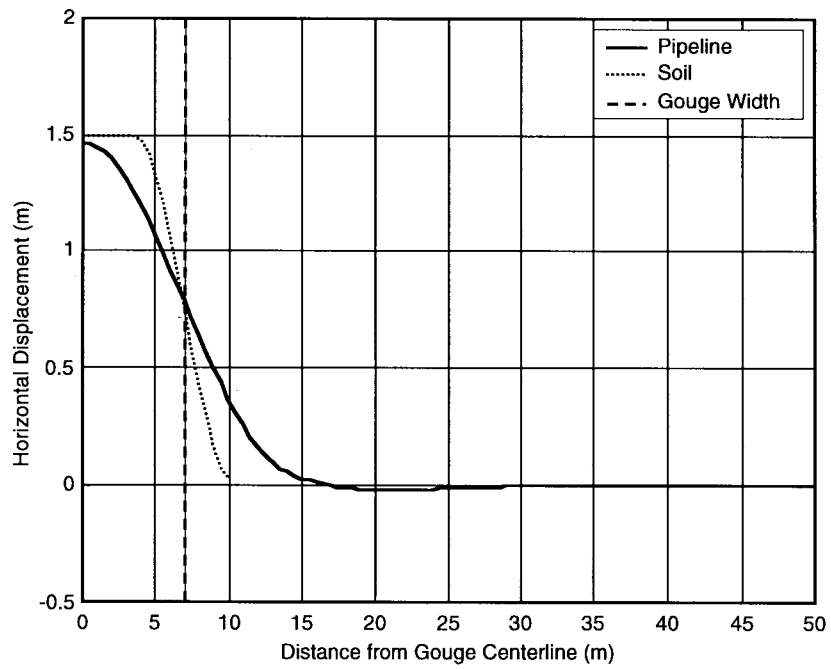

Figure 6.6. Profile of the imposed subgouge displacement field and computed pipeline displacement response for Case X.

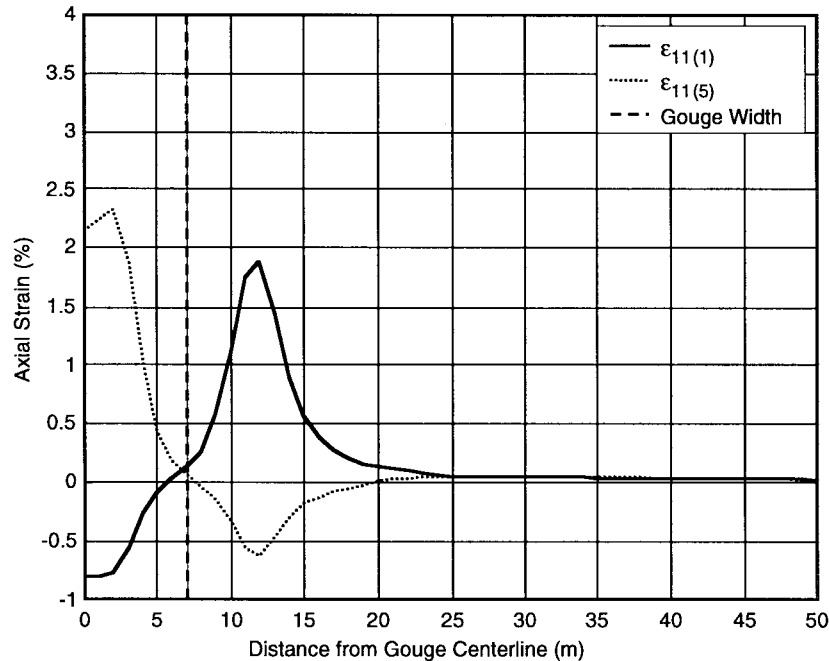

Figure 6.7. Longitudinal distribution of axial strain for Case X.

Consequently this effect was not incorporated into the design trench depths.

### 6.6 Responses to specific ERDC review questions

In this section, original questions by CRREL are given in italic font, C-CORE responses to these questions follow “C-CORE:,” and CRREL comments on the C-CORE responses follow “CRREL:.” CRREL had no follow-up questions for C-CORE. The figures and references in the original correspondence have been updated to figures and references contained in this report.

1. *Chapter 5 of the February 1999 C-CORE Final Report “Lake Erie Ice Scour/Pipeline Design” (C-CORE 1999a) does not make it clear that the PRISE approach for designing buried pipelines is adaptable or appropriate to the problem of a pipeline in an un-backfilled trench, although assumptions regarding infilling over time and during a scour event have been described and used. Specifically, is the prescribed boundary condition determined from the PRISE centrifuge experiments (presumably conducted without a trench configuration) appropriate for an un-backfilled trench, or even for a trench that has filled in over time? How would the design be affected if the boundary condition were not appropriate? If the boundary condition is appropriate, then a clarifying discussion of the analysis’ assumptions regarding infilling over time and during a scour event, particularly how these*

*effects bring the calculated stress values “to within acceptable levels” (as stated in C-CORE 1999a, Section 5.6), would be helpful to our understanding.*

**C-CORE:** The PRISE experiments did not include any pipe sections. These experiments were used to determine only scour forces and sub-scour soil displacement relationships in the absence of any other structures (e.g., pipelines or infilled trenches). (C-CORE has conducted some proprietary centrifuge tests of scour–soil–pipe interaction.)

The interaction of these sub-scour soil displacements with the pipeline was assessed through a pipe–soil interaction analysis. This decoupling of the ice–soil from soil–pipe interaction is common in pipeline engineering. For example, the same principle is adopted for pipelines crossing moving slopes, where the slope analysis for movements is decoupled from the soil movement–pipe interaction analysis.

In the pipe–soil interaction analysis, the lateral interaction of the soil with the pipe is modeled by the *p*-*y* springs. The response of these springs shows how increasing the relative movement of the pipe to the soil changes the lateral pressure acting on the pipe. It was assumed in the analysis that the pipe interacted directly with the native soil (that is, the presence of a partly infilled trench was ignored). This direct interaction was considered to provide a reasonable upper bound to the lateral pressures (*p*) acting on the pipe, which in turn causes the maximum flexural strains in the pipe. Section 5.4 of the report considered the effect of a trench around

the pipe. An initial clearance was assumed between the pipe and the trench wall, which moderated the  $p$ - $y$  response and a reduction in pipe strains.

**CRREL:** The question was meant to ask: is the *prescribed boundary condition* depicted in Fig. No. B-6 adaptable or appropriate to the problem of a pipeline in an un-backfilled trench? Our original question apparently was not clear and is not answered by the response above. However, it has been answered in the C-CORE response in item 2 below, which contains the following clarifying quote: “The horizontal bending strains are calculated assuming that the full free-field horizontal deformation acts directly on the pipe through soil at its intact strength.... The free-field horizontal displacement will be reduced through the trench effect. The soil interacting with the pipe will be at a lower strength than the intact soil. This conservatism is assumed to more than offset the effect of small vertical deformations acting on the pipe.”

2. *The questions raised in the June 21, 1999 letter from OPE, Inc., to Mr. Heino Prah (National Fuel 2000) regarding the use of a two-dimensional rather than a three-dimensional analysis should be addressed in greater detail. In the September 1999 C-CORE Contract Report “Comparison of Lake Erie and Northstar Pipeline Designs for Ice Scour” (C-CORE 1999b) there is a short description stating that the ice scour process was simplified as a two-dimensional problem... “and tabulation of the number of degrees of freedom of the pipe finite elements of both the C-CORE and Northstar analyses.” It appears that the Northstar analysis used a three-dimensional approach, yet this is not discussed. We would appreciate clarification of this. Also, what are the consequences of using a 2-D rather than 3-D analysis?*

**C-CORE:** The pipe–soil interaction analyses for Northstar and the Lake Erie Crossing were both two-dimensional. For the Northstar analysis the vertical and horizontal sub-scour deformations at the pipe spring-line were vectorally combined. The resultant deformation magnitude was then used in a 2-D  $p$ - $y$ -type analysis to assess the pipe response. For the Lake Erie Crossing, only the horizontal sub-scour deformations were used in the 2-D  $p$ - $y$ -type analysis.

The vertical soil deformation acting on the pipe was considered to have a negligible effect on the pipe–soil interaction because of the presence of the open trench as described in the remainder of this section.

An ice keel with an attack angle of 15-degree scouring to a depth of 1.4 m (4.59 ft) and a width of 14 m (45.9 ft) is considered as shown in Figure 6.3i. This

scour is a typical 100-year design scour. The trench in cohesive material is considered to be 10 ft deep with 10-ft basal width and trench walls at 60 degrees to the horizontal. The 1.1-m- (3.5-ft-) diameter concrete coated pipe is considered centered in the trench.

The trench will be left open after construction. The trench may become slightly infilled by the sedimentation from the jetted cuttings or the lakebed load. This sediment will have very low strengths and is ignored in the following analysis. The trench wall may also fail in the longer term as effective stresses reduce to a new equilibrium condition following the excavation process. These trench infilling mechanisms are not considered to affect the following discussion.

The sub-gouge deformations are assessed from the PRISE program as shown by Woodworth-Lynas et al. (1996). The free-field sub-scour soil displacements accumulate from points A' to B' i) of Figure 6.3. The sub-scour displacement vectors are shown at three elevations under point B'. At the pipe spring-line elevation, the deformation vector magnitude is 6.2 ft. It should be noted that the free-field horizontal component is 5.1 ft, which is a very large percentage (82%) of the total deformation. This percentage increases significantly as the vertical deformation component is reduced through interaction with the trench and its infill.

The free-field vertical deformation is caused by the subduction of soil under the inclined ice keel. The soil is mainly subducted because of the surface restraint caused by the presence of the fully developed spoil heap in front of the scouring ice keel. As the keel advances towards the partly infilled trench, the spoil heap under the advancing keel will fall into the open trench, as shown in Figure 6.3ii. The removal of the spoil heap permits the soil in front of the keel to be displaced upwards rather than downwards. This will minimize the vertical deformations developed under the ice keel.

The PRISE program showed that an initial lateral keel movement of about 50 scour depths (about 230 ft) is required to develop steady-state scouring conditions and the maximum spoil heap in front of the keel. This distance is significantly greater than the trench width.

As the keel moves further from ii to iii, the material displaced by the scouring keel will continue to infill the trench. The scour forces acting on the keel will cause a failure of the trench wall. The expected failure surface is along O-B' which is about 12 degrees to horizontal. The failed wedge of soil will distort and move laterally against the poorly compacted infill in the trench. Vertical deformations under the keel will therefore continue to be minimized.

As the keel passes over the trench, any vertical deformation under the keel will be further dissipated

by lateral displacement of the infill along the pipeline (out from under the scour) and by compression of the poorly compacted infill. Any small vertical loads acting on the pipe will cause flexure of the pipe in a vertical plane. These small downward pipe loads through pipe flexure cause upward movements of the pipe outside of the scour. These upward movements are reacted through the resistance per unit length of the submerged pipe weight and the resistance of infill around and above the pipe. Both of these resistances are very low and so require a significant pipeline length to react the downward loads acting on the pipe. The curvature of the pipe is therefore low, with associated small bending strains.

These considerations of the significantly reduced vertical deformation acting on the pipe and the low resistance of the pipe outside the scour to upward motion provide the assumption that vertical bending strains in the pipe are insignificant compared to the horizontal bending strains. The horizontal bending strains are calculated assuming that the full free-field horizontal deformation acts directly on the pipe through soil at its intact strength. The above discussion shows the conservatism in this assumption. The free-field horizontal displacement will be reduced through the trench effect. The soil interacting with the pipe will be at a lower strength than the intact soil. This conservatism is assumed to more than offset the effect of small vertical deformations acting on the pipe.

**CRREL:** The response clarifies the use of a two-dimensional horizontal-loading analysis via a convincing qualitative argument. It also clarifies the conservatism built into the analysis arising from the analysis' assumption that the free-field horizontal deformation governs the pipe loading.

*3. Another issue raised in National Fuel (2000) is the calculation of the p-y curves. C-CORE has clarified the reason for not using a hyperbolic curve beyond ultimate p and y values in its Contract Report C-CORE (1999b). As National Fuel (2000) indicated, the selection of the secant stiffness instead of the hyperbolic curve from the origin to the ultimate p and y values results in a lower p value at the same y value. The ASCE guidelines used by C-CORE indicate that the non-linear p-y relationship for clays is expected to be similar to that for sands. We would appreciate your views regarding the impact of using the secant stiffness instead of the hyperbolic curve—in the region of the p-y relationship from the origin up to the ultimate p and y values—on the overall design.*

**C-CORE:** Figure 5.10 of C-CORE (1999a) shows an

example of the mobilized lateral soil reactions along the pipeline length. The load on the pipe is dominated by the ultimate soil reaction  $p_u$  due to the high relative pipe soil displacements. The hyperbolic curve recommended by ASCE is considered appropriate for relatively small relative pipe-soil displacements. The bilinear curve is an alternative in the ASCE guidelines and was considered more appropriate for this analysis due to the high relative movements. The hyperbolic model overpredicts the ultimate soil reaction at large relative displacements.

**CRREL:** The response clarifies the question by stating “The bilinear curve is an alternative in the ASCE guidelines and was considered more appropriate for this analysis due to the high relative movements.” It was not clear previously that the loads governing the design were dominated by the ultimate soil reaction  $p_u$ .

*4. A further issue raised in National Fuel (2000) is the apparent reliance on results from analysis with a 0.2-m clearance (pipe to keel). Again, we would appreciate clarifying comments.*

**C-CORE:** The “National Fuel Gas Letter” (National Fuel 2000) states on page 3 that “No finite element analysis results of 0.2-m clearance between the pipe crown and scour base can be found in C-CORE’s report. It seems that the recommendations given in C-CORE’s report were not directly related to its analysis results.” These statements are not correct. Section 5.6 and Table 5.11 provide such analytical results. Table 5.11 is reproduced in part below with cross references to the pipe zones considered and the related steel pipe crown clearances. Models TCPLes1 and TCPLes3 confirmed the strain-based design recommendations. Models TCPLes2 and TCPLes4 confirmed the stress-based design recommendations.

**CRREL:** Table 5.11 in our copy of the C-CORE Final Report (C-CORE 1999a) does not include the clearance data given in the table [next page]. This response clarifies that the analysis in question was conducted.

*5. In the comparison between the Lake Erie and Northstar pipeline designs (C-CORE 1999b) there is a discussion of the bearing stress, indicating that C-CORE took this into account. Is this accomplished by the  $H^*$  term shown in Fig. B-4 of the C-CORE Final Report (C-CORE 1999a)? We ask this because this term appears to only affect the analysis for cohesionless soils, yet C-CORE (1999b) indicates that “for clay the consequence is an increased yield load and thus increased structural loads imparted to the pipeline.” Please clarify this as well.*

Model (#)	Zone	Cu (kPa)	Scour width (m)	Scour depth (m)	Trench depth (m)	Clearance (m)
TCPLes1	A	100	14	1.4	2.9	0.5
TCPLes 2	A	100	14	1.0	3.0	1.0
TCPLes 3	F&G	25	14	0.8	2.0	0.2
TCPLes 4	F&G	25	14	0.4	1.9	0.5

**C-CORE:** Figure 5.10 of C-CORE (1999a) shows the effect of the bearing stress on the ultimate soil reactions  $p_u$  inside and outside of the scour. The  $H^*$  term is the depth of burial equivalent to the addition of the vertical ice bearing stress. This  $H^*$  term (instead of  $H$ ) in Figure B-9 is used to calculate the bearing capacity factor,  $N_c$ . The change in  $N_c$  reflects the change in failure mechanism of the pipe-soil system under the restraint of the ice keel. The  $H^*$  term is NOT used to calculate the yield displacement,  $y_u$ , under the ice keel. The secant stiffness of the  $p$ - $y$  curve under the scour is taken to be the same as that outside of the scour.

**CRREL:** That C-CORE used the  $H^*$  term to calculate  $N_c$  answers the question.

6. Also in C-CORE (1999b) there is a discussion of the effect of the temperature change from pipe installation to operation, yet it is not indicated whether or not this change should be considered. Should it?

**C-CORE:** Temperature changes between installation and operation are not significant for a gas pipeline. The opposite is true for an oil pipeline like that proposed for Northstar. The effects of temperature changes were not therefore considered in the Lake Erie analyses.

**CRREL:** This response answers the question.

## 7.0 PIPELINE MONITORING AND REPAIR

The pipeline and associated facilities of the Millennium Pipeline Project would be operated and maintained in accordance with DOT Minimum Federal Safety Standards in 49 CFR, Part 192 (FERC 1999). This section addresses monitoring and repair of the Millennium Pipeline Lake Erie crossing, with specific attention to issues related to ice scour.

### 7.1 As-built survey

Millennium will conduct an as-built survey of the Lake Erie crossing following pipeline installation,

hydrostatic testing, de-watering, and drying. This survey will include internal and external inspections. It will detail the final location of the pipeline, its external condition, and its trenched situation relative to the natural lakebed, and it will identify any areas where remedial action is required (e.g., to eliminate potential spanning, etc.). This survey data will become the baseline for future inspections of the pipeline.

### 7.2 Continuous monitoring

Pipeline facilities will include automatic shutdown valves on each side of the Lake Erie crossing. The crossing will be monitored 24 hours per day, seven days per week, by a telemetry system reporting to a gas control center. Operators will be constantly apprised of the operating parameters in the pipeline and will immediately detect any significant changes in operating conditions, such as loss of line pressure. If loss of pressure occurs, its cause will be investigated. If the cause is a leak or line break, the shutdown valves will be closed immediately and steps will be taken to effect a repair. Catastrophic loss of pressure would trigger automatic valve closure.

### 7.3 Internal and external inspections

The Lake Erie crossing will include facilities to launch and recover instrumented robots or “pigs” to inspect the pipeline internally. Pigging can determine pipeline curvature, wall integrity, effects of corrosion, and damage to the concrete coating. Prior to placing the Lake Erie crossing into service, a pig survey of the line will be undertaken to ascertain sections where future repair may be needed, such as isolated sections impacted during pipe lay or trenching. This survey also will be used to establish a baseline for the condition and alignment of the as-built pipeline.

External surveys of the pipeline will normally be undertaken in the spring and will include side-scan sonar and sub-bottom profiler systems. These surveys will document infill of the trench and sediment erosion that could lead to pipeline spanning. Additionally the survey will identify lakebed scours in the route corridor, whether by ice keels, fishing gear, or dragged anchors.

Any unexpected or unusual images will be further investigated with a remote operated vehicle (ROV) and, if necessary, by divers. Divers will also verify that the installed corrosion protection systems are in place and functioning correctly.

### *7.3.1 Monitoring pipeline response to ice scour*

Internal and external surveys will be conducted along the Lake Erie crossing to document ice scour activity and the pipeline's response to it. After the initial as-built surveys, these surveys will be conducted approximately every three years, depending on ice conditions. These surveys will detect any damage caused by ice scour, relate scour characteristics to pipe response, and assess the "best estimate" 100-year scour depth. Besides early detection of possible damage, the program will assess the pipeline design for ice scour protection and will help determine whether ice-mitigation techniques warrant development. A similar ice scour monitoring program has been prepared for the Northstar pipeline in the Alaskan Beaufort Sea (FERC 1999, p. 5–160).

During periods of possible ice scour, more frequent aerial patrols will be undertaken over the pipeline route. If substantial ice ridging occurs near the pipeline, even though no damage is evident, external inspection of the relevant location(s) will be undertaken as soon as weather and ice conditions permit. Based on the findings of the external inspections, an internal inspection may be undertaken. All inspections will be followed by an evaluation and then, if warranted, by repair procedures.

### *7.3.2 Other inspections*

The Lake Erie Crossing marine pipeline is designed to minimize the risk of damage from outside forces such as dragged anchors, trawl doors, and dropped objects, in addition to ice scour. If an impact to the pipeline from outside forces is reported or suspected, an external inspection of the pipeline will be undertaken. Based on the findings, internal inspection and repair may be undertaken.

### *7.3.3 Damage assessment and repair*

The design tensile strain limit of 2.5% is an allowable operational limit, not the strain at which the pipeline ruptures. This latter value should be about 1.5 times higher. That is, the pipe will not rupture in response to an ice scour or impact event unless tensile strains exceed about 3.8%. Millennium will base the final pipe design on the results of strength tests on the pipe. The 7.5-cm high-density, steel-reinforced concrete coating, installed on the pipe for stability, will give added protection to the pipe. Thus, rupture should be an extremely rare occurrence.

The monitoring programs described above will detect any changes in the condition of the pipeline. These changes will be assessed as they are detected. If such changes are considered detrimental, repair procedures would be undertaken long before the integrity of the system was threatened.

As required by regulation, comprehensive emergency response procedures (ERP) and marine pipeline repair procedures will be developed prior to placing the pipeline into service. Equipment and materials necessary to effect a full repair of the pipeline will be procured and placed at strategic locations. Contracts with local and specialist service providers (e.g., boat operators, divers, etc.) necessary to effect or assist with a repair will be arranged.

The goal of ERP is to safeguard the public and employees in the event of an emergency, to reduce the potential for destruction of property and interruption of gas deliveries, and to minimize the impact on the environment. These procedures shall provide the overall strategy for the emergency response effort, general responder responsibilities, and basic response procedures.

In the unlikely event of a catastrophic failure of the pipeline, gas through the line would immediately be stopped by shutdown valves on each side of the lake. The natural gas (principally methane) that is released would bubble through the water column and disperse into the atmosphere.

Pipeline repair on the bottom of Lake Erie, whether planned or in response to an emergency, would take 2–3 weeks. Repair and replacement pipe welds would be made utilizing a hyperbaric procedure from a diving/repair vessel. If a competent ice cover exists at the repair location, an icebreaker vessel will be used to break up and move the ice.

## **8.0 SEDIMENT SAMPLING**

BEAK International, Inc. (BII) acted on behalf of the Millennium Project to sample and assess sediment quality along the proposed Lake Erie crossing because pipeline trenching could release contaminated sediments. Concerns raised during public review of the Millennium Pipeline Project Draft Environmental Impact Statement (FERC 1999), and its supporting documents (e.g., Fitchko 1999), focused primarily on the adequacy of the sampling program.

This chapter summarizes the methods used for sediment sampling, the concerns raised during public comment, and the results of the ERDC review of these issues. All issues were resolved through a question–answer exchange between BII and the ERDC

Environmental Laboratory (EL) at the Waterways Experiment Station (WES). No additional sampling or analyses were required.

### **8.1 Overview of sediment-quality sampling program**

Early in the Millennium Project study process, sediment quality was recognized as an important factor in routing a pipeline across Lake Erie. The disturbance of contaminated sediments due to pipeline trenching has the potential for contaminant release, resulting in increased bioaccumulation and possibly having sublethal or even lethal effects on sensitive aquatic biota. Moreover, sediment quality guidelines have been established by regulatory agencies that preclude the disturbance of contaminated sediments or require the development of comprehensive and costly contaminated sediment management procedures.

Based on a review of Lake Erie sediment quality data, it was determined that elevated contaminant concentrations occurred in the depositional basins of the lake, whereas relatively uncontaminated sediments occurred in nondepositional areas (e.g., the high-energy near-shore and the offshore moraines or sills separating the depositional basins). As a result, the pipeline was routed along one such moraine, known as the Long Point–Erie sill or Pennsylvania ridge.

To confirm that sediment quality along the pipeline route would not be a constraint to the proposed undertaking, a survey was undertaken in May–June 1997 along a 10-km- (6.2-mile-) wide study corridor superimposed on the pipeline route. Approximately 100 sampling locations were established along a grid system within the study corridor. Surficial sediment samples, or in a few instances core sediment samples, were collected at most of the sampling locations by ponar dredge and gravity corer, respectively. At a few locations, sediment collection was unsuccessful due to the occurrence of hardpan clay, coarse substrate (e.g., gravel, cobble), or bedrock/boulders. The sediment samples were analyzed for mercury as an indicator parameter of contamination.

Subsequently a sediment-quality sampling program was developed involving the collection of recent sediment (i.e., from the water/sediment interface to the interface with the underlying glaciolacustrine sediment) at the Canada–U.S. border and three equidistant locations between the border and the near-shore. An additional near-shore sampling location was established due to alteration of the landfall location. At each sampling location, sufficient sediment volume was collected to facilitate bulk chemical composition analysis and elutriate testing. As little or no recent sediment was present, glaciolacustrine sediment was

collected by corer and composited for analysis of sediment particle size (percent sand, silt, and clay), percent loss on ignition, total organic carbon, total Kjeldahl nitrogen, ammonia, cyanide, metal scan, arsenic, mercury, oil and grease, organochlorine pesticide scan, acid and base/neutral extractables scan, and volatile priority pollutant scan. Water samples for chemical analysis were also collected at each site as a requirement of the elutriate testing. In addition, shorter sediment cores, 33–36 cm (13–14 inches), were collected at the three deeper sampling locations, as well as at the near-shore location at the altered landfall location, and sub-sectioned at 3-cm (1.2-inch) intervals for mercury analysis. This sediment quality sampling program was reviewed and approved by the U.S. Army Corps of Engineers (USACE). Based on the good sediment quality found along the proposed pipeline crossing route, the USACE deemed that elutriate testing of the sediments was not required.

### **8.2 Concerns raised during public comment**

The main concerns about the adequacy of sediment sampling were the number and location of samples, the depth of sampling, and the use of mercury as an indicator contaminant. Key issues about the number and location of samples included the following:

- The density of the sampling grid may have been too large or the coring too shallow to penetrate recent uncontaminated sediment. Specifically there was concern that sediment deposition may have covered contaminated sediment deeper than the 14-inch core depth.
- During surface sampling, the use of ponar grab samples may not take a sample of sufficient depth.
- Compositing sediment samples could dilute sediment contamination.
- The sampling protocol was insufficient in both density and depth.
- Some of the pipeline may lie in a contaminated area on the U.S. side of the lake.
- There was concern over what is and what is not a depositional zone.

The key issue raised about the use of mercury as an indicator contaminant was that mercury is not an appropriate indicator of potential inorganic and organic contamination. Some reviewers felt that the case had not been convincingly made that mercury could be used as a surrogate for other forms of chemical contamination in the lake.

The ERDC team reviewed these concerns and Millennium's responses to them. Those that were not fully addressed are presented in the following section.



### 8.3 Concerns addressed during ERDC review

The main premise of the sediment sampling conducted along the proposed pipeline route is that the route crosses through the nondepositional Long Point–Erie sill for its entire length, generally avoiding areas characterized by more heavily contaminated sediments. Many of the concerns that the EL researcher had upon reading the report entitled “Comprehensive Study Report: Environmental Impact Assessment of the Proposed Millennium Project Lake Erie Crossing” (Fitchko 1999) echoed those raised during public review by Andrew Martin (1999). These concerns were generally addressed in Millennium’s response to Data Request No. 10 dated August 6, 1999. However, because the sediment sampling plan and interpretation of sediment contaminant results depend heavily on the supposition that the pipeline route crosses a nondepositional area, a number of points needed clarification and expansion. The specific questions from EL are in italics, followed by the response from BII.

*1. What are the reasons for expecting that sediment metal concentrations in Lake Erie will co-vary? Discuss in relation to contaminant input, contaminant sources, mixing, and deposition patterns. Two correlation coefficients are reported in the response to data request No. 10 between Hg and Cd. It is also stated that correlations existed between Hg and other metals and organics. These correlations should be shown in a table for either discrete data sets or pooled historical data.*

*With the validity of the entire sediment sampling strategy resting upon the relationships between contaminants, such data presentations would assist evaluation of the use of Hg as a tracer contaminant.*

**BII:** Metal pollution in Lake Erie is derived from a wide variety of sources, including tributary inputs, shoreline erosion, industrial and domestic effluent discharges, and atmospheric fallout. The atmosphere is now widely recognized as a major source of metal pollution in coastal, marine, and lacustrine environments. There is reasonable agreement in reported atmospheric loadings of metals to Lake Erie (Nriagu et al. 1979). Estimated sources and sinks of metals in Lake Erie are listed in Table 8.1.

The data in Table 8.1 indicate that a large fraction (approximately 60% for copper and zinc, and 30% for lead) of the total metal burden of the lake is contributed by the Detroit River. Direct atmospheric inputs account for 8%, 34%, and 13% of the copper, lead, and zinc, respectively, delivered annually to the lake, whereas the annual contributions of copper, lead, and zinc from sewage effluents are 18%, 15%, and 11%, respectively.

The dispersion pathways of anthropogenic metals and organic contaminants in the Great Lakes are poorly understood.\* Substances that enter the lake are subjected to physical transportation processes and may be

\*Personal communication, A. Mudroch, AMU Ecosystems, 2000.

**Table 8.1. Sources and sinks of metals in Lake Erie.\***

Source	Flux rate ( $\times 10^3$ kg/y)			
	Cadmium	Copper	Lead	Zinc
Detroit River (import from Upper Lakes)	—	1,640	630	5,220
Tributaries (U.S.)	—	100	52	271
Tributaries (Ontario)	—	31	19	140
Shoreline erosion	7.9	190	221	308
Sewage discharges	5.5	448	283	739
Atmospheric inputs	39	206	645	903
Dredged material	4.2	42	56	375
TOTAL (all sources)		2,477	1,906	7,776
EXPORT Niagara River and Welland Canal		1,320	660	4,400
Retained in sediments		1,157	1,246	3,376

\*Source: Nriagu et al. (1979).

dispersed over wide areas before being transferred out of the water mass into the sediments. Anthropogenic inputs to the lake sediments are greatest in areas with highest sedimentation rates and are not dependent on proximity to the source areas (Kemp and Thomas 1976). The high sedimentation rates in the eastern basin of Lake Erie are presumably a function of the easterly location of the basin in the lake. The prevailing westerly winds and the west-to-east flow of the Great Lakes system towards the Atlantic Ocean enables the most easterly basins to act as sinks for the fine-grained suspended material. In addition, surface fine-grained sediments in the shallow western basin of Lake Erie are continuously resuspended and transported into the central and eastern basins of the lake.

The binding sites for inorganic contaminants (such as metals) and organic contaminants (such as PCBs) in the sediments are the hydroxyl groups of the natural iron and manganese oxyhydroxides and the coatings of organic matter on these oxyhydroxides (Tessier et al. 1996). Fine-grained clay materials in the sediments act as a matrix for the deposition of the oxyhydroxides and the organic matter (Jenne 1977). Because of these binding processes and the fact that the fine-grained materials settle in the depositional basins of lakes, the highest concentrations of the inorganic and organic contaminants occur in the sediments of depositional basins. This is supported by the relationship among the contaminants, organic carbon and fine-grained sediments found in different studies of lake sediments (e.g., Thomas and Jaquet 1976). The relationship between metals, PCBs, and organic carbon in sediments collected from Lake Erie during the 1970s survey undertaken by Environment Canada is shown in Table 8.2.

A relationship was also determined for the metals in

the composite sediment core samples collected along the proposed Millennium Lake Erie Crossing route (Table 8.3). However, there was no relationship between the metals and organic carbon in the composite cores, which indicates a different binding mechanism between the sediment particles and the metals than that found in the sediments in depositional basins. This lack of a relationship between metals and organic carbon likely reflects the nondepositional nature of the sediments along the proposed pipeline route. The concentrations of the metals in the composite cores were similar to those in the precolonial sediments (Table 8.4) in which the origin of the metals is, most likely, from natural materials in the lake's drainage basin.

As indicated in Tables 8.2 and 8.3, there is a significant ( $p < 0.05$ ) positive relationship between mercury and the other metals and PCBs in the sediments. Based on these relationships, the use of mercury as a tracer contaminant is technically valid.

2. *What was the sediment deposition rate (or rates) used in determining the depth of the cores taken along the proposed pipeline route? Fitchko (1999) presents a summary of the literature on sources of sediment and sediment deposition rates in Lake Erie, but the sediment deposition rate used in computing the depth of cores was not given. Explain why the deposition rates used in determining the depth of cores were conservative and why they should remain constant along the entire pipeline route if that was indeed the assumption?*

**III:** Sedimentation rates in Lake Erie were presented in Figure 23 of the Fitchko (1999) report based on a study undertaken by Kemp et al. (1977). The data indicate that, in the eastern basin of Lake Erie,

**Table 8.2. Correlation of metals, PCBs, and organic carbon in Lake Erie sediments.<sup>1</sup>**

	<i>Cd</i>	<i>Cr</i>	<i>Cu</i>	<i>Pb</i>	<i>Hg</i>	<i>Ni</i>	<i>Zn</i>	<i>PCBs</i>	<i>Org. C</i> <sup>2</sup>
<i>Cd</i>	1								
<i>Cr</i>	0.984	1							
<i>Cu</i>	0.886	0.811	1						
<i>Pb</i>	0.993	0.967	0.896	1					
<i>Hg</i>	0.954	0.959	0.762	0.954	1				
<i>Ni</i>	0.934	0.885	0.840	0.962	0.933	1			
<i>Zn</i>	0.951	0.906	0.871	0.970	0.899	0.977	1		
<i>PCBs</i>	0.943	0.971	0.794	0.918	0.894	0.811	0.866	1	
<i>Org. C</i>	0.903	0.849	0.897	0.938	0.824	0.926	0.957	0.815	1

<sup>1</sup> Source: A. Mudroch, AMU Ecosystems, 2000, pers. comm.

<sup>2</sup> *Org. C*: Total organic carbon.

**Table 8.3. Correlation of metals and organic carbon in composite sediment core samples collected along the Millennium Lake Erie Crossing route.<sup>1</sup>**

	Cd	Hg	Cr	Cu	Pb	Ni	Zn	Org. C <sup>2</sup>
Cd	1							
Hg	0.995	1						
Cr	0.828	0.841	1					
Cu	0.943	0.953	0.819	1				
Pb	0.638	0.630	0.800	0.501	1			
Ni	0.604	0.607	0.842	0.491	0.971	1		
Zn	0.858	0.851	0.875	0.728	0.935	0.905	1	
Org. C	0.244	0.271	0.241	0.329	-0.102	0.013	0.090	1

<sup>1</sup> Source: A. Mudroch, AMU Ecosystems, 2000, pers. comm.

<sup>2</sup> Org. C: Total organic carbon.

sedimentation rates are greatest in the deep waters south and east of Long Point and appear to decrease towards the periphery of the basin toward the north, south, and east. The highest sedimentation rates are generally found where the thickness of the fine-grained sediment is greatest, whereas the lowest rates occur where the thickness of fine-grained sediment is the least (Kemp et al. 1977). Table 8.5 presents sedimentation rates in the eastern basin of Lake Erie determined by Kemp et al. (1977). These data indicate that sedimentation rates in the area of the proposed pipeline route will range from 0 to 1.2 mm/y. Based on these rates, the depth of recent sediment (i.e., since 1890) in the area of the pipeline route will range from 0 to 12 cm.

The cores collected for mercury analysis along the proposed pipeline route ranged from 27 to 36 cm in depth (depending upon corer penetration). This depth of sediment core collection is conservative since it was based on the findings of Azcue et al. (1996), who reported that sediment cores collected from a depositional area of the central basin had maximum metal concentrations at about the 18-cm depth and pre-industrial metal levels at about the 36-cm depth (see Table 4.21 in Fitchko [1999]).

Concentration profiles of Pb<sup>210</sup> obtained in the study of sedimentation rates by Robbins et al. (1978) indicated uniform rates of sediment deposition in Lake Erie and Lake Ontario over about the past 100 years or so. Generally consistent rates of sedimentation were also obtained from analysis of Cs<sup>137</sup> concentration profiles in cores collected in Lake Erie and Lake Ontario by the same authors. Considering these findings, it can be expected that the deposition (i.e., sedimentation) rates will generally remain constant along the entire pipeline route.

3. The documents reviewed present a somewhat confusing picture of recent sediment deposition on the Long Point–Erie sill. Page 4:34 of Fitchko (1999) states that there was little evidence of deposition of recent sediments along the study corridor, although slightly anaerobic sediments occurred just offshore on the U.S.

**Table 8.4. Mean concentrations of metals in precolonial sediments and in the composite sediment cores collected along the proposed pipeline route.<sup>1</sup>**

Metal	Concentration (µg/g)	
	Precolonial	Composite sediment cores
Arsenic	3.7	3.41 <sup>2</sup>
Cadmium	0.37	0.30
Chromium	35	17.5
Copper	29	13.9
Lead	15	13.9
Mercury	0.078	0.075
Nickel	48	16.9
Zinc	98	40

<sup>1</sup> Source: A. Mudroch, AMU Ecosystems, 2000, pers. comm.

<sup>2</sup> Value for station CS8 was not included in the calculation of the mean value for arsenic. As indicated in Fitchko (1999), the elevated level of arsenic at this sampling location was likely due to natural post-depositional migration of arsenic in the sediment pore water and subsequent oxidation of arsenate at the sediment surface with adsorption and concentration particularly onto manganese oxyhydroxides. If the value for this station is included, the mean value for arsenic would be 5.9 µg/g.

**Table 8.5. Sedimentation rates in eastern basin of Lake Erie.<sup>1</sup>**

Station number	Sedimentation rate (mm/y)
Stations within the depositional zone	
L-28	3.8
L-29	4.1
L-30	min. 2.5 max. 3.4
L-31	min. 1.0 max. 1.3
M-30	>2.2
M-31	6.6
M-32	min. 6.5 max. 8.5
M-34	min. 4.1 max. 4.5
Stations on the periphery of the depositional zone and in the nearshore zone:	
K-30	0.3
K-31	0.3
K-22	0.5
N-35	0.5
O-30	0
O-31	1.2
O-32	0.2
O-33	0

<sup>1</sup> Source: Kemp et al. (1977).

side and at three stations on the Canadian side. This was inferred from examination of sediment cores and from the survey information. However, twice in the response to data request No. 10, it was stated that recent sediments could not be discerned from the underlying sediments. Was the reason for being unable to discern recent sediments in the cores because recent sediments were not present or were the recent and historical sediments too similar to permit discrimination? Provide details of the sediment characteristics in core samples and surveys that allowed you to distinguish between recent deposition and the glaciolacustrine clays and glacial till and clear up the seemingly contradictory statements.

**BII:** As presented in Section 4.9, CSR (1998) classified the surficial “geological” units along the pipeline route into five main categories: glacial till; fine- to coarse-grained sand; glaciolacustrine fines; a combination of silt/clay, sand, gravel, cobble and some boulders (restricted to a zone immediately adjacent to the exposed bedrock in the U.S. nearshore); and bedrock.

Based on sediment core sample analysis, a veneer of lag sand and/or fine sediments could be discerned in some of the sediment cores collected along the pipeline route (Table 8.6). These surficial layers could not be

discerned from the seismic records.\* However, the fine deposits could be discerned as a turbidity plume when disturbed by the underwater video camera (CSR 1998).

These surficial layers, if present, would generally contain some fine-grained recent sediment incorporated temporarily during the process of dispersal to the depositional basin of the lake. However, due to the thin overlay and admixture with uncontaminated sediment from natural sources, these surficial sediments representative of a nondepositional zone would contain low levels of contaminants (Thomas and Mudroch 1979). This is evidenced by the low mercury concentrations reported by Fitchko (1997) in those surficial sediment samples described as slightly anaerobic at four and three locations (out of approximately 100 sampling stations along the pipeline corridor) in the U.S. and Canadian nearshore, respectively, as provided below.

Station no. <sup>1</sup>	Mercury concentration (µg/g)
S2	0.06
N3	0.19
S3	<0.04
N4	0.14
S40	<0.04
S45	0.08
S46	0.07

<sup>1</sup> See Figure 26 in Fitchko (1999).

Most of these mercury concentrations are below the mean levels in precolonial sediments (see Table 8.4) and all of the mercury concentrations are below the Ontario Ministry of the Environment (MOE) “lowest effect level” (LEL) sediment quality guideline. Moreover, most of the remaining surficial sediment samples had mercury concentrations below the mean level in precolonial sediments and all of the remaining samples were below the MOE LEL sediment quality guideline.

4. Page 4:49 of Fitchko (1999) states that silt materials contaminant concentrations should be similar to pre-industrial concentrations. Was this the case?

**BII:** The mean metal concentrations in precolonial sediments provided by Kemp and Thomas (1976) and Azcue et al. (1996), as well as in composite sediment cores collected along the originally proposed pipeline route, are presented in Table 8.4.

As indicated by the values presented in Table 8.4,

\* Personal communication, D. Horton, CSR, 2000.

**Table 8.6. Surficial sediment core sample logs.<sup>1</sup>**

<i>Location<sup>2</sup></i>	<i>Sediment depth (cm)</i>	<i>Sediment description</i>
1A	0–5	Clay, very soft, occasional small shells, gravelly, gray.
	>5	Clay, firm, organic lenses, light brown.
1B <sup>3</sup>	0–37	Alternating dark gray-brown and dark gray layers; appears to be mostly fine sand; some mussel shells at surface.
2	Surface	Clay, soft, shells (mussels), dark gray.
	Below surface	Clay, very soft, dark gray, minor organic lenses, occasional pebbles.
3	0–2	Sand, loose, fine with shells overlying clay, soft, tan (oxidized layer at base of sand).
	>2	Clay, soft, organic lenses, gray.
4	0–4	Sand, fine, loose, clay, soft, sandy, tan.
	>4	Clay, soft, sandy, gray with numerous organic layers.
5	Surface	Clay, very stiff, gravel (pebbles) and numerous mussels at lakebed.
	Below surface	Clay, stiff to very stiff, brown, gravel on top.
6	0–15	Clay, very soft, sandy, gray, occasional mussels at lakebed.
	15–16	Clay, stiff, light brown.
	>16	Clay, very soft, sandy gray.
7	0–1	Veneer of sand, gravel, shells, numerous small mussels and soft clay.
	>1	Clay, stiff, light brown.
8	0–1	Veneer of clay, sandy, gravelly, shelly, numerous mussels.
	>1	Clay, very stiff.
9	Surface	Clay, soft, minor sand, abundant organic material, gray.
	Below surface	Clay, gray, soft, sandy, abundant organic material, layered.

<sup>1</sup> Source: Racal Pelagos (1997).

<sup>2</sup> See Figure 27 in Fitchko (1999).

<sup>3</sup> Source: CSR (1998).

the mean concentrations of the metals in the composite sediment cores are lower than those in Lake Erie precolonial sediments.

*5. In the sediment sampling plan the assumption was that sediment resuspension and reworking were constant. Therefore surface concentrations should be representative of deeper contaminant concentrations. Was this shown to be a correct assumption for the sampling program?*

**BII:** Based on the responses to the previous four WES concerns, the assumption that the surface contaminant concentrations are representative of deeper concentrations is technically valid. This assumption has been confirmed by the determination that mercury concentrations in sediment cores collected along the pipeline route and subsampled at 3-cm intervals were all below the analytical detection limit and the mean mercury concentration in pre-colonial sediments (see Tables 4.22 and 4.25 in Fitchko [1999]).

#### **8.4 Status of concerns**

The BII responses to the EL concerns regarding the sediment sampling and analysis program answered the questions raised. A major concern was the utility of

mercury as a tracer contaminant. Based on the relatively limited major sources of contamination to the lake, we felt that there was an excellent chance that correlations between mercury and other contaminants should exist. However, this had not been demonstrated in either FERC (1999) or the supporting material. Our concerns on this issue were answered by the strong correlations between mercury and other contaminants in two independent data sets, including the sediment cores collected for the Millennium Project.

Another major concern was the depth of sediment cores and the depositional environment along the pipeline route. Depth of sediment sampling is a complex issue and depends to a great extent on the depositional environment of the pipeline route. Detailed examination of the geophysical survey results in conjunction with the clarifications on sediment deposition rates and physical observations of core stratigraphy indicate that the deposition rates used for determining core sample depths were conservative and should encompass historical contamination, if present. Compositing a core to obtain an overall value is an acceptable procedure. Resuspension of the material during trenching operations will mix the entire core depth in the water column. Therefore, the composite is representative of real-world exposures.

The data in FERC (1999) and supporting documentation show that concentrations of mercury and other metals in the sediments along the pipeline route are relatively low. The comparison to precolonial sediment levels in the response clarified the data presentation and put present-day sediment metal concentrations into better perspective.

Therefore, all sediment-sampling issues examined during the ERDC review were addressed satisfactorily. This conclusion holds true for the ~20% deeper trench depths required in zones H–J (Chapter 6) due to the revised 100-year ice scour depths. The additional material excavated would be uncontaminated sediment and thus would not increase environmental exposures to contaminated sediments.

## 9.0 TURBIDITY MODELING

BEAK International, Inc. (BII) acted on behalf of the Millennium Project to model turbidity generation and sediment deposition arising during construction of the Lake Erie crossing. Concerns raised during public review of the Millennium Pipeline Project Draft Environmental Impact Statement (FERC 1999), and its supporting documents (e.g., Fitchko 1999), focused primarily on the adequacy of the modeling and the sensitivity of the results to pipeline trench depth.

This chapter briefly describes the turbidity modeling and presents the ERDC review of it. Most issues were resolved through a question–answer exchange between BII and Dr. Mark Dortch of the ERDC Environmental Laboratory (EL) at the Waterways Experiment Station (WES) (Section 9.2). Dr. Paul Schroeder at EL conducted his own analyses with a different model to quantify the effects of model simplifications made by BII (Section 9.3). However, BII was not required to conduct additional analyses.

### 9.1 Overview of turbidity modeling

Turbidity generation and siltation from pipeline trenching and directional drilling for the Millennium Lake Erie crossing were identified as potentially having a significant ecological and aesthetic impact. Turbidity modeling was undertaken to predict

- The concentration, physical extent, and duration of the suspended solids plume produced by the operation of a jet sled during pipeline trenching.
- The potential increase in sediment layer thickness on either side of the trench.
- The concentration, physical extent, and duration of the suspended solids plume caused by loss of drilling

mud from the directional drilling operation.

The initial modeling of the suspended-sediment plume produced by the jet sled operation was based on the following assumptions:

rate of travel .....	0.017 m/s (200 ft/h)
trench depth .....	2.6 m (8.5 ft)
trench width .....	4.0 m (13 ft)
nozzle diameter .....	25 cm (10 inches)
nozzle height .....	3 m (10 ft)
nozzle offset .....	2 m (6 ft)
nozzle angle .....	45 degrees above horizontal
hours of operation .....	continuous
discharge velocity .....	1–5 m/s (3–16 ft/s)
discharge concentration .....	10–200 g/L
min. depth of operation .....	9 m (30 ft).

It was assumed that the jet sled has two discharge ports (one on each side), with sediment being discharged equally on each side, and that the operation is completed in two passes. Although two passes would be required for trenching, the turbidity plume modeling predictions were conservatively based on the discharge of the entire volume of sediments in the trench. Under some conditions a suction hose may be used to remove sediment from the trench and discharge it at the surface from the barge at 18 m (59 ft) forward and 14 m (46 ft) off center. The flow rate of the suction pump was estimated to be 0.8 m<sup>3</sup>/s (18,500 gpm).

With regard to the conditions in Lake Erie, it was assumed that the sediment particle density was 2.65 g/cm<sup>3</sup>. Analyses of the sediments along the proposed pipeline corridor indicate that the sediment is approximately 75% solids by mass. The sediment solids density was estimated to be approximately 1.39 g/cm<sup>3</sup>. The following assumptions were also made:

water temperature .....	15°C (59°F)
ambient average .....	0–0.05 m/s
hypolimnion current	(0–0.16 ft/s)
ambient average .....	0.03–0.18 m/s
epilimnion current	(0.1–0.6 ft/s).

A second modeling iteration for the jet sled discharge was undertaken based on a minimum depth of operation of 7.6 m (25 ft).

A third modeling iteration for the jet sled discharge was undertaken based on the following revised assumptions:

rate of travel .....	0.042 m/s (500 ft/h)
trench depth .....	2.0 or 2.8 m (6.6 or

	9.2 ft) depending on route section
trench width (top) .....	8.0, 10.4, or 11.8 m (26, 34, or 39 ft) depending on route section
trench width (bottom) .....	2.4 m (7.9 ft)
trench cross section .....	12.8, 14.6, or 19.8 m <sup>2</sup> (138, 157, or 213 ft <sup>2</sup> ) depending on route section
nozzle diameter .....	40.6 cm (16 inches)
nozzle height .....	3–4.6 m (10–15 ft)
nozzle offset .....	2–3 m (6–10 ft)
nozzle angle .....	45° above horizontal
hours of operation .....	continuous
discharge velocity .....	1.5–3 m/s (4.9–10 ft/s)
discharge concentration .....	10–200 g/L
min. depth of operation .....	11.7 m (38 ft).

It was again assumed that the jet sled has two discharge ports (one on each side), with sediment being discharged equally on each side. However, the jet sled operation may require multiple passes to achieve the recommended trench depths. For modeling purposes, a conservative assumption was made that the entire volume of sediment from the trench would be removed with only two passes (each pass removing half of the sediment volume). Should more than two passes be required, the resulting plumes would be of lesser extent and duration.

Turbidity modeling was also used to predict the impacts of sediment resuspension as a result of the directional drilling. The initial modeling was based on six stages to the directional drilling, of which only the first and last use drilling mud (bentonite mixture), whereas the others use water. The specific gravity of the drilling mud ranged from 1.10 to 1.15, which corresponds to a suspended solids concentration range of approximately 160–240 g/L.

The initial pilot hole was less than 25 mm (10 inches) in diameter and was expected to lose 500 barrels/h (0.022 m<sup>3</sup>/s) for a total of two hours. During the pullback stage, the hole diameter was 1.2 m (48 inches) and was expected to lose 1300 barrels/h (0.057 m<sup>3</sup>/s) and take approximately one day.

A second modeling iteration for the directional drill discharge was undertaken based on drilling mud loss during all stages of directional drilling. The rate of bentonite loss increases with the hole diameter. The lowest rate of 10 barrels per minute (1.6 m<sup>3</sup>/min) starts after the pilot hole is completed. The largest rate of 20 barrels per minute (3.2 m<sup>3</sup>/min) occurs during the final

reaming process just prior to the final pipe pullback. The specific gravity of the drilling mud (bentonite) was assumed to be 1.15, which corresponds to a suspended solids concentration of 240 g/L. Under calm conditions (unmixed), the along-shore current was assumed to be 0.1 m/s (0.32 ft/s), whereas under storm conditions (mixed), the along-shore current was assumed to be 0.2 m/s (0.65 ft/s).

The modeling approach was divided into four sections:

- *Dense Plume Model*. This model component was used to predict the jet trajectory from the nozzle to the lake bed (modeled by CORMIX1).
- *Settling Model*. This model component was used to predict the distribution of the disturbed sediments in the areas adjacent to the pipeline trench.
- *Visible Plume Model*. This model component was used to predict the extent and duration of the turbidity plume caused by the jet sled operation and directional drilling.
- *Dense Turbidity Plume*. This model component was used to determine the behavior of a dense turbidity plume along the lake bottom as a result of directional drilling under calm conditions.

The turbidity plume modeling was based on maximum plume dimensions (length and width) for total suspended solids concentrations of 35, 1,000, and 10,000 mg/L.

## 9.2 Concerns addressed during the ERDC review

This section contains the question–answer exchange between EL and BII. These are grouped according to the Millennium documents cited. The specific EL questions are in italics, followed by the response from BII. In a few cases, the cycle repeats.

### 9.2.1 General observation regarding EL review comments

The intent of the turbidity plume modeling was to provide an estimate of the extent of the impact associated with the operation of the jet sled during Lake Erie Crossing pipeline trenching operations. The approach used was technically valid and of sufficient rigor to scope the issues of concern as part of the environmental impact assessment process. The CORMIX model used is an expert system developed by Cornell University to predict the mixing characteristics of a discharge into a natural water body. The model is widely used and accepted by various regulatory agencies in Canada and the United States. Moreover, the conservative nature of the assumptions

used in this modeling study resulted in an overestimate of the extent of the impacts. The use of a more detailed modeling approach would likely provide impact estimates that are smaller than the estimates provided. Additionally, a detailed modeling study would require a more significant effort in terms of time and resources and would have a more intense data requirement than is currently available. Since the results of the turbidity plume modeling have been deemed environmentally acceptable by the state regulatory agencies, it is opined that any additional, more detailed modeling is unnecessary at this time.

### 9.2.2 Comprehensive Study Report (Fitchko 1999), main text

*Page 5.32. It is stated that the maximum plume area will be 28,000 m<sup>2</sup> for TSS = 1000 mg/L and for the Canadian near-shore. However, data in Appendix 3 indicate the area will be nearly twice as large, or 48,000 m<sup>2</sup>. There are other similar understated inconsistencies.*

**BII:** If the plume is assumed to be rectangular, then calculating the area by multiplying the length by the width would be appropriate (i.e., 300 m × 160 m = 48,000 m<sup>2</sup>). However, the plume is a shape similar to an ellipse that is larger at one end. The area of this shape is approximately 60% of the area calculated using the “rectangular” assumption.

### 9.2.3 Comprehensive Study Report (Fitchko 1999), Appendix 3

*1. General: It surely would have been helpful if the authors had presented a figure to schematize each of the four types of modeling approaches employed (i.e., dense plume, settling model, visible plume, and dense turbidity plume), showing orientation and features relative to the trench, variable definitions relative to these features, etc. The lack of figures almost gives the impression of trying to make this as difficult to follow as possible.*

**BII:** Figures depicting the orientation and other features of the plume were not provided in our report as the design specifications for the jetting operations have not been finalized. As stated above, the analysis was intended to scope the issues of concern and identify areas where more information is required. When information was missing, assumptions were made that would err on the conservative side. Given this approach, the results should be viewed as worst case. Since a comprehensive monitoring program will be implemented during construction, an exhaustive analysis of turbidity predictions is not required.

Moreover, as indicated in the Monitoring Plan requested and accepted by the Pennsylvania Department of Environmental Protection (PaDEP), a “footprint” of the visible plume with appropriate TSS concentration isopleths (e.g., 10,000 mg/L, 1,000 mg/L, 500 mg/L, and 35 mg/L) will be modeled and plotted for each zone. These modeling predictions will be based on final design specifications and used to establish the sampling grid that will overlap the predicted plume in each zone.

*2. Page A3.3. There is not nearly enough information presented to evaluate the application of the CORMIX1 model for the dense jet. As a minimum, the following should be supplied:*

*a. model assumptions and limitations;*

**BII:** As indicated above, CORMIX is generally accepted as a plume model in both Canada and the United States. If a detailed modeling study were necessary, then a complete listing of assumptions and limitations of CORMIX would be appropriate. However, as a screening tool and to conservatively predict construction-related impacts, a complete listing of the assumptions and limitations of CORMIX was not required.

*b. why this model option was selected over the other CORMIX package modeling options, i.e., how or in what way the jet sled discharge fits this model and its assumptions;*

**BII:** CORMIX1 refers to the single-port discharge model included in the CORMIX package. The other components (i.e., multi-port and surface discharges) are not appropriate to examine the behavior of the plume as it exits the jet sled.

*c. a list of model input variables and values used;*

**BII:** This information was provided on page A3.1.

*d. a list of model parameters (e.g., coefficients), values used, and justification for their use;*

**BII:** The coefficients used in CORMIX are not changeable (i.e., they are hard-wired into the program). In previous projects, BEAK has examined the source code for CORMIX and determined that it is consistent with jet theory presented in the literature. The coefficients used are generally biased toward a conservative estimate (i.e., predicts a longer plume with lower dilution).



e. any attempt to validate the model for this use, and those results.

**BII:** There were no attempts to validate the predictions of CORMIX since the data are not available. However, at the request of the PaDEP, a detailed monitoring plan has been developed and accepted to confirm the results of the turbidity plume modeling.

*Additionally, since this jet will contain high concentrations of sediment, there will be a negatively buoyant jet-plume effect that should have been taken into consideration. There is no mention of this effect or the input of data to describe the density difference between the jet and ambient water. If TSS concentration of the jet was used to determine the density of the jet effluent, then what formula was used to compute jet fluid density from TSS concentration data?*

**BII:** The discharge from the jet sled will likely produce a dense bottom plume as indicated by CORMIX. The plume is expected to be 0.5–2 m thick once it contacts the bottom. The density of the jet discharge was based on an ambient water temperature of 15°C and a suspended sediment concentration of 30–200 g/L. The density difference was calculated using

$$\Delta \rho = 0.00062 * \text{TSS}.$$

This relationship is used in the CE-QUAL-W2 model developed by the Corps of Engineers. The resulting density difference ranges from 17 to 123 kg/m<sup>3</sup>.

3. Page A3.3. What value of Z was used in Equation 1, the mid-height of the plume or the top of the plume? The top of the plume makes more sense, but it is not clear what was used.

**BII:** The distance from the lake bottom to the top of the dense plume was used and is represented as Z.

4. Page A3.4. Is S the cross-sectional area of the trench? If yes, then Equation 3 makes sense, otherwise it does not. The definition of S should be stated more precisely. Equation 3 assumes that the redeposited sediment will have the same porosity as the undisturbed sediment in the trench, thus there is no effect of unconsolidation during removal of the consolidated sediments in the trench. The redeposited sediment will likely have a greater porosity, will be less consolidated, and thus have a greater thickness than predicted by Equation 3. Given the expected porosity, or bulk density, of the redeposited sediment and the porosity, or bulk density, of the trench sediment prior to removal, it should

be possible to more accurately estimate the redeposited sediment thickness.

**BII:** Yes, S represents the cross-sectional area of the trench. Since there were no data available regarding the variation of porosity with depth or the porosity of freshly deposited sediment, it was reasonable to assume the same porosity. While the initial deposits of sediments may be somewhat thicker than predicted, these unconsolidated sediments will be subject to transport by wave and current action. A portion of these sediments will eventually redeposit in the trench. The sediment remaining in the deposit areas will eventually consolidate to a porosity similar to the undisturbed sediment. Additionally, a fraction of the sediment will remain within the trench during the operation of the jet sled and will not contribute to the deposit thickness or the turbidity plume. This fraction is highly variable and, in order to be conservative, was ignored.

*EL response: To ignore bulking is to underestimate the depth of burial of environmental resources and therefore nonconservative. Reasonable guesses of porosity as a function of time can be made from settling and consolidation data bases for dredged material.*

**BII:** BEAK concurs that disregard of sediment bulking as a variable affecting redeposited sediment thickness will result in an underestimate of the depth of burial of environmental resources. As indicated in the EA Report (Fitchko 1999), the magnitude of the impacts on the benthic community will be a function of several factors: the duration and volume of trench excavation; relative survival rate of the species dependent primarily on their capacity for drifting or moving away from the disturbance; relative species survival rates dependent primarily on their capacity to move through any spoil mounds formed adjacent to the trench and thus avoid crushing or smothering; and relative species recolonization rates after natural backfilling. Although the predicted depth of burial will likely be greater taking into account sediment bulking and may result in greater reductions in biomass, species number, and population size of the benthic biota, recolonization is expected to be rapid and the impact will be localized and temporary.

5. Page A3.4. It is stated that 10% to 45% of the particles did not settle in the analysis. I don't follow this statement. Does this mean that the finer size classes of sediment required such long distances to settle that their results were off the graph, or what? All particles should settle eventually. The statement is made earlier on Page A3.4 that the total sediment thickness at any point is calculated as the sum of all the individual

*thicknesses that have a distributed distance equal to or greater than the distance at that point. Therefore, it seems that all particle size classes should be included in the calculation of the redeposited sediment thicknesses, thus all particles settle somewhere. The Corps of Engineers experiences have been that about 97% of dredged material disposed in aqueous environments impacts the bottom near the vicinity of discharge, and the rest remains in suspension much longer. The 10 to 45% statement does not seem consistent with this result.*

**BII:** In the particle size distributions provided by GAI Consultants Inc., a fraction of the particles were smaller than 0.001 mm and were not accounted for. These particles would contribute to the deposit thickness, but since they have a very small settling velocity, they would be spread out over a large distance and contribute a very small increase to the overall deposit thickness. It was determined that this minor component would not add to the overall construction-related impacts with respect to deposit thickness. However, this fine fraction was taken into account in turbidity modeling.

*6. Page A3.4. At the bottom of the page, it is stated that since the suction discharge is located above the water, it will not form a dense bottom plume. How do the authors know this will be the case?*

If the discharge is placed 3.7 m above the water surface, the energy dissipation (i.e., mixing) of the discharge at the water surface will initially dilute the plume and in turn decrease the density difference between the plume and the ambient water. Even if the plume sinks to the bottom, mixing with the ambient water will “spread” the sediment through the water column.

*EL response: Discharges above the water surface tend to promote development of density flow because the jet loses most of its horizontal momentum in the air and upon hitting the surface. Discharges into the air under steady conditions actually entrain less ambient water than submerged discharges, particularly angled discharges, because they tend to entrain the discharged water rather than jetting through the clean water column at an angle. Additionally, the discharge from the suction pump is larger than the ambient flow through the cross-sectional area of the discharge plume, yielding little potential for significant dilution under steady-state operation. Thus, it is most likely that the plume will sink to the bottom and form a bottom layer of moving sediment (i.e., a bottom density current). As Dr. Schroeder points out in his memo (Section 9.3), the D-CORMIX model could be used to assess this. No further*

*action on this issue is expected, rather the point is made for future analyses.*

**BII:** BEAK will take into account the potential applicability of the D-CORMIX model to better model the dense jet resulting from surface discharge if future analyses are required.

*7. Table 1. Several additional cases should be run, such as Core 7 with Case 1 conditions and Core 2 with Case 3 conditions. It seems that otherwise, it is not readily apparent which are the best and worst case conditions/results. These additional runs would help bracket outcomes.*

**BII:** As indicated in the response to PaDEP Deficiency Question 2i, additional modeling has been undertaken to predict the turbidity plumes produced by the operation of a jet sled within five zones along the pipeline route in U.S. waters based on zone-specific recommended trench depths, average water depths, and sediment particle sizes. These modeling results supercede those in Table 1, as they take into account zone-specific conditions. However, to respond to your comment, one extreme case would be if a sediment with a large particle size (i.e., Core 2) is allowed to settle over a smaller vertical distance (i.e., 0.5 m) and is not carried by an ambient current, i.e., the ambient current is 0 m/s. This would result in the sediments being deposited in a thicker layer over a shorter distance. The opposite case would be if a fine sediment (i.e., Core 7) is allowed to settle over a longer vertical distance (i.e., 2 m) and is carried by a stronger ambient current. This would result in the sediments being deposited in a thinner layer over a longer distance. By reversing some of the cores, the case represented would fall between the two extremes represented above.

*8. Page A3.6. What is the basis for the assumption of when the plume is visible, i.e., Secchi depth equal to 1.0 m?*

**BII:** A Secchi depth of 1 m seemed reasonable. The Ontario MOE (1979) had established a water quality criterion for Secchi disc transparency of at least 1.2 m for recreation and aesthetics.

*9. Page A3.6. Where does the value of  $q = 123,000$  g/s come from? I tried using the jet exit diameter, velocity, and sediment concentration, and did not arrive at this value. A figure earlier may have helped clear this up for me.*

**BII:** The discharge rate was calculated by multiplying

the trench area (5.2 m<sup>2</sup>), the rate of travel (0.017 m/s), the bulk density of the sediment (2.65 × 10<sup>6</sup> g/m<sup>3</sup>), and one minus the porosity (the porosity was assumed to be 0.46 based on measured deposition rates). This method was conservative because it assumed that all of the sediment contributed to the turbidity plume. The information on the jet sled discharge was not used since it was highly dependent on the equipment and operating conditions. The two models were decoupled to avoid carryover of potential errors and maintain a conservative approach.

10. Page A3.5. Equation 4 does not look appropriate for the steady-state analyses that are presented (e.g., Figure 3) since it has time in it. The steady-state form of this equation should have been presented.

**BII:** The dynamic version of the model was used in order to estimate the extent of the plume if steady-state conditions did not exist and to estimate the time required for the plume to dissipate after cessation of jet sled operation. The steady-state model could not accomplish either of these. The dynamic model could be used to represent steady-state conditions, but the opposite is not true. By using the dynamic model, it was determined that the dissipation time was slightly less than the travel time to the end of the plume.

11. Page A3.6. What sediment size and settling velocity were used for the visible plume model results presented in the figures and tables? What value is used for  $t^*$  in Equation 4? All model input variables should be listed.

**BII:** a) A representative particle size of 0.08 mm with a settling velocity of 0.0005 m/s was used in all of the simulations. In a more detailed modeling study, individual particle class sizes would be considered to better estimate the visible plume length.

b) In equation 4,  $t^*$  represents the time associated with each discrete release of sediment over the simulation period. At time  $t$ , the value of  $t^*$  for each release is calculated by the difference between the total elapsed time ( $t$ ) and the release time.

c) The input parameters for the model were

Total elapsed time ( $t$ )	.....	30 hours
Solids discharge rate ( $q$ )	.....	123,000 g/s
Dispersion velocity ( $w$ )	.....	0.005 m/s
Water depth ( $D$ )	.....	3.5 m at Canadian landfall; 7.6 m at American landfall

Settling velocity ( $W$ )	.....	0.005 m/s
Ambient velocity ( $u$ )	.....	0.05 m/s or 0.01 m/s at bottom; 0.18 m/s or 0.03 m/s at surface.

12. Page A3.5. Equation 4 assumes that the plume is well mixed vertically throughout the water column. Some sensitivity runs should be presented with other assumed mixed depths, such as 0.5 and 0.25 of the total depth. Conceptually, it seems that the vertical extent of the plumes used in the visible plume model should equal the thickness of the plume computed by CORMIX1.

**BII:** As a screening level conservative estimate, it was assumed that all the sediment contributed to the turbidity plume over the entire water column. This decreased the removal due to sedimentation by increasing the required settling distance.

13. Page A3.7. It does not seem reasonable that with deeper water (U.S. near-shore versus Canadian near-shore) the plume will be visible at greater distances, especially since it is stated elsewhere that the model is relatively insensitive to settling rate, and thus settling depth. Thus, it seems that greater depth (greater dilution) should decrease the visible plume distance, not the reverse. There are, however, some inconsistencies that can be observed between Tables 2 and 3. For example, the plume dimensions in Table 2 for the 35 and 1,000 mg/L TSS concentrations are smaller than the corresponding values in Table 3, yet the plume dimensions in Table 2 for the 10,000 mg/L TSS concentrations are larger than the corresponding values in Table 3, thus the results do not appear to be consistent. If the calculations are correct, then perhaps the model is more sensitive to settling than indicated in other documents.

**BII:** At the source point, the depth of water controls the initial concentration of the sediment (i.e., the shallower the water, the higher the concentration). As the plume moves away from the source, water depth controls the removal rate of the sediment by sedimentation (i.e., the shallower the water, the faster the removal rate). When considering sensitivity to water depth, the location of interest must be taken into account. The location where the sensitivity changes from a positive to a negative is a function of parameters such as settling velocity, ambient current, and dispersion. When a sensitivity analysis is conducted, the results depend on the length of the plume. For a relatively short plume, an increase in water depth will decrease sediment concentrations, while at a distance, the same increase could represent an increase in

sediment concentrations relative to the base case.

14. Page A3.8. How was the drill mud plume thickness of 0.2 m derived from CORMIX1?

**BI:** The directional drill hole was represented as a single port submerged discharge. The exit velocity and density were based on estimates provided by the directional drilling contractor. The CORMIX predictions indicated that under calm conditions the flow of drilling mud would form a dense bottom plume approximately 0.2 m thick and travel at a speed approximately equal to the ambient current.

15. Page A3.9. Were equations 1–3 used to calculate the bentonite accumulation thickness on the bottom of 2.4 mm?

**BI:** The predicted depths are based on a similar approach as equations 1 through 3 except that only one particle size was used. The drilling mud is comprised of uniform bentonite clay with a particle size of 0.001 mm.

9.2.4 January 28, 2000 letter, supplemental response no. 3 to Penn. DEP letter of December 3, 1999, question no. 21

1. Page 5. I believe the DO analysis is flawed. A  $k_d$  value on the order of  $10^{-5} \text{ day}^{-1}$  was used. This value is more representative of the diagenesis of refractive sediment organic matter and is not representative of the oxidation rate of reduced sediments and pore water that have been taken from an anaerobic environment and exposed to oxygenated water. Such sediments can contain reduced iron and manganese, ammonium, sulfide, and possibly methane. When introduced to oxygenated water, much of the reduced matter is oxidized rather rapidly, exerting a rapid chemical oxygen demand. Our respirometer studies with dredged sediments indicate COD decay rates on the order of  $1.5 \text{ day}^{-1}$ . Also, equation 4 should be restated from the first order COD (or BOD) decay law, or

$$\Delta O_2 = C_{TSS} \text{COC} (1 - e^{-k_d t}).$$

Using  $k_d = 1.5 \text{ day}^{-1}$ ,  $C_{TSS} = 10,000 \text{ mg/L}$ ,  $\text{COC} = 3 \text{ g/1,000 g sediment}$  (typical value found from dredged material respirometer studies), and  $t = 5 \text{ hours}$ , the above equation yields  $\Delta O_2 = 8.0 \text{ mg/L}$ . In contrast, using the equation shown in the memo (equation 4) with these values yields  $\Delta O_2 = 9.4 \text{ mg/L}$ . These values are the dissolved oxygen (DO) demand that would be exerted in a respirometer or BOD bottle over five hours given a water and dredged material mixture that results

in 10,000 mg/L of sediment. This is not necessarily the DO uptake that would occur wherever the TSS concentration is 10,000 mg/L in the prototype water column since it is believed that much of the COD is associated with dissolved reduced constituents released from the pore water that may not disperse as far as the solids. However, it is still possible that much greater DO demand will be exerted than anticipated, especially in the near field, highly concentrated TSS region. This DO demand will be rapidly diffused and diluted, will be short lived, and may be exerted in a smaller area than the 10,000 mg/L TSS contour. If DO is potentially a concern, then there are methods for measuring COD and  $k_d$  for dredged material. However, a more sophisticated modeling analysis would need to be employed so that 3D (or at least 2D) advection, diffusion, COD loading (g/sec), COD decay, and DO uptake can all be taken into account simultaneously. A copy of a draft paper I have written describes approaches for measuring and modeling DO uptake associated with dredged material disposal. This paper can be furnished to the authors if this is of interest or concern.

**BI:** As the turbidity plume moves away from the jet sled, oxygen consumption will decrease with the decrease in TSS concentration as it mixes with the surrounding water. While it is true that the COD would decay on a first-order relationship, the simple approach does exclude mixing of ambient oxygenated water as the plume spreads, i.e., as the oxygen is consumed by the suspended sediment, there is a significant amount of oxygen being drawn into the plume from the surrounding water to offset this consumption. A detailed monitoring plan has been developed, that has been accepted by the PDEP, to monitor potential oxygen depletion in the hypolimnion during trenching operations. Please provide us with a copy of your draft report for our review and confirmation that your respirometer results are applicable to the Lake Erie sediments along the proposed pipeline route.

2. Monitoring should include temperature and DO monitoring within the 10,000 mg/L TSS contour. The memo did not make this clear.

**BI:** The monitoring plan requires temperature and DO measurements at a minimum of three sampling locations within the plume, i.e., near-, mid- and far-field. These locations correspond to the 10,000 mg/L, 1,000 mg/L, and 35 mg/L contours. Therefore, temperature and DO monitoring will occur within the 10,000 mg/L contour, where practicable from a safety standpoint.

9.2.5 Millennium pipeline letter of December 27, 1999, in response to Penn. DEP letter of December 3, 1999, and in response to OPR/DEER, ERC II memo dated October 1, 1999

1. Section 2i. Was the average particle size and associated settling velocity used for the visible plume model to generate the results that are presented? If so, then the preferred approach would be to apply the plume model for each class of sediment size to calculate  $C_i(x,y,t)$  and add the class concentration values together to get the total concentration. It is possible that the visible plume may extend farther than indicated when considering the smaller sediment sizes. This comment applies not only to this memo but to all analyses associated with estimating the visible plume size.

**BII:** See response to Appendix 3, No. 11a (Section 9.2.3).

2. Section 2i table. Please explain why the table in section 2i shows larger plume dimensions than the BEAK report for Zone F and for the 35 and 1,000 mg/L TSS concentrations, but it shows smaller dimensions than the BEAK report for the 10,000 mg/L TSS concentration. Look at the jet sled results as an example. This result hints at some inconsistency that should be explained to avoid any doubts as to whether the calculations are correct.

**BII:** Through the course of this project, many iterations of the modeling exercise have been performed and differences have included sectioning the pipeline route into zones and changes in jet sled speed, trench depth, trench width, trench shape, and water depth. Individual cores, water depths, and trench configuration have also been assigned to each of the zones at various times. For each iteration the plume lengths have been recalculated and may be directly comparable to the previous iteration.

9.2.6 Millennium Pipeline Response to Data Request of OPR/DEER, ERC II dated March 16, 1998

Response a. It is difficult to believe that the plume model is not sensitive to settling velocity. It would be very beneficial if model results for various settling velocities were presented. The effect of settling velocity may help explain some of the inconsistencies in plume dimensions that I have pointed out elsewhere. As stated previously above, it seems that the plume analysis should take into account the particle size distribution, not simply use the average particle size for settling.

**BII:** See response to Appendix 3, No. 12 (Section 9.2.3).

9.2.7 General observation

After reviewing all of the documents and memos, it is apparent that there is a large variation in plume results that are reported due to the various parameter values used to address a variety of questions. It would be beneficial if the plume results were presented with a range of expected dimensions (e.g., minimum and maximum expected dimensions) that can be calculated by considering the range of parameter values expected for all input parameters, e.g., settling velocity, ambient current, depth, dispersion velocity, etc. This will require lots of runs, but only the minimum and maximum dimensions need to be reported. Of course, I feel that this analysis should be done with the full particle size distribution for sediment (and associated settling velocities), not just for the average size.

**BII:** As indicated above, the approach used was sufficient to scope the issues of concern at the technical level appropriate to meet environmental impact assessment requirements. The approach is conservative, resulting in an overestimate of the extent of the impacts. As the results of the turbidity plume modeling have been deemed as environmentally acceptable by the state regulatory agencies, it is opined that any additional more detailed modeling is unnecessary at this time.

9.2.8 Other comments

1. I agree with Dr. Schroeder that the results for the turbidity analysis are conservative, but the results for sediment deposition are low (Section 9.3). Thus, no further modeling of the turbidity plume is necessary at this time. I believe that the results provided by Dr. Schroeder can be used to provide more accurate estimates of the deposition thickness.

**BII:** BEAK concurs that the results for the turbidity analysis are conservative, but the results for the sediment deposition are low. However, on the basis of our response above to the first comment, increased impact on benthic biota due to greater localized sediment burial may be offset by decreased effects due to lesser sedimentation with distance from the trench. Again, recolonization is expected to be rapid and the net impact will be negligible.

2. Upon review of the monitoring plan for Pennsylvania waters, only the following two comments are offered. Please define near-, mid-, and far-field monitoring locations on page 4. These locations should be defined as a range of distances, e.g., near-field is within 10 to 100 m of the trench, etc. What range of TSS concentrations will be used in the correlation with turbidity? There should not be any problems for TSS of

*less than 100 mg/L but I would be careful when the TSS concentration is greater than 200 mg/L.*

**BII:** As indicated in Section 9.2.4 (item 2), monitoring of temperature and dissolved oxygen will occur within the 10,000 mg/L TSS contour, where practicable from a safety standpoint. This would represent the near-field monitoring location. Mid- and far-field monitoring locations will be located within the 1,000 and 35 mg/L TSS contours, respectively.

With respect to correlation of turbidity with TSS concentrations, we are currently monitoring TSS and turbidity during storm events at two water treatment plants with intakes in Lake Erie near Port Stanley. In addition to providing background levels of TSS and turbidity for Lake Erie, the data will allow us to determine whether there is a consistent relationship between the two parameters at higher TSS concentrations.

### 9.3 ERDC/EL turbidity modeling

This section contains results of turbidity and sediment-deposition modeling by Dr. Paul Schroeder at EL. It follows a memo format.

1. Reference Appendix 3 dated January 1999 by BEAK International Incorporated (Fitchko 1999).

2. I have reviewed Appendix 3 to determine the adequacy and conservativeness of the turbidity plume predictions and solids deposition predictions. The screening models and methods employed were examined and evaluated. The predictions were compared to results of other screening methods and experiences with dredged material disposal in open water by pipelines. Recommendations for future modeling are provided.

3. In general, the modeling reported in Appendix 3 does not represent the best screening predictions for either deposition or turbidity estimates. The turbidity predictions appear to be conservative insofar as it predicts much greater solids dispersion than is likely. Therefore, the size of the turbidity plume is probably greatly overestimated.

4. The predictions were made using a discrete settling velocity instead of a flocculent settling velocity. This approach is very conservative in estimating the settling velocity. However, the discrete settling velocity used in the analysis was for a particle size of 0.08 mm while the actual mean particle size shown in Figure 1 of Appendix 3 is only about 0.01 mm. About 85% of the material is finer than 0.08 mm. The discrete settling velocity for the mean particle size is about 0.3 times as large as used in the predictions given in Appendix 3. This is an unconservative selection of a discrete settling velocity. Using the USACE DREDGE model, the

predicted turbidity plume in 3.5 m of water would have been an oval about 2400 m long and about 1200 m wide, having an area of 2,200,000 sq m. In 7.6 m of water the plume would have a length of 1000 m and a maximum width of 600 m, comprising an area of 470,000 sq m. Using the assumed settling velocity of 0.0005 m/s for a 0.08-mm particle, the USACE DREDGE model predicted a turbidity plume of up to 250 m in diameter or 49,000 sq m in area for a 7.6-m water depth, and up to 750 m in diameter or 450,000 sq m in area for a 3.5-m water depth. The results of the modeling are generally consistent with the predictions in Appendix 3 using the Schubel et al. equation. Schubel's equation produces reliable predictions if the solids discharge and settling rates are known.

5. The use of a flocculent settling velocity would yield much smaller visible turbidity plume estimates. The discrete settling velocity employed in Appendix 3 is equal to the minimum expected flocculent settling velocity for dredged material. Average flocculent settling velocities are likely to be at least three times as large. With such a higher settling velocity, no visible surface turbidity plume would be expected in 7.6 m of water and only a 100-m-diameter visible surface plume would be expected in 3.5 m of water. Therefore, the predictions of the turbidity plume are likely to be quite conservative due to overprediction of solids entrainment in the water column and underprediction of the settling velocity due to neglecting flocculation.

6. The settling model for prediction of deposition is largely inappropriate because the plume velocity is not constant. The plume velocity results from both the initial momentum and density differences. In addition, deposition is caused by settling from a spreading, collapsing density flow. Settling is not discrete and not from the jet height. Settling of sand may be discrete but settling of the rest is by flocculation or zone settling. It would be better to estimate the deposition by computing the shape of the resulting mound based on experience with similar materials. Our experience is that coarse sand settles from fluid mud with a slope of about 1V:5H, fine sand at 1V:10H, coarse silt at 1V:80H, fine silt at 1V:200H, and clay at 1V:500H. If such slopes are assumed, the deposition for unidirectional spreading on both sides of the trench would yield the depths given in Table 1 for short-term (several days after placement) and long-term (several months after placement) conditions. Unidirectional spreading deposits material in a mound that tails off only outward perpendicularly away from the trench. Table 2 gives the depths for bi-directional spreading on both sides of the trench. Bi-directional spreading deposits material in a mound tailing off both outward from the trench and inward toward the trench from the point of the jet impact on

**Table 1. Deposition for unidirectional spreading.**

<i>Distance from location where jet strikes the bottom (m)</i>	<i>Short-term thickness (m)</i>	<i>Long-term thickness (m)</i>
0	0.33	0.26
0.7	0.26	0.21
3.3	0.23	0.140
9	0.155	0.097
21.4	0.130	0.068
40	0.093	0.037
86.5	0.00	0.00

**Table 2. Deposition for bi-directional spreading.**

<i>Distance from location where jet strikes the bottom (m)</i>	<i>Short-term thickness (m)</i>	<i>Long-term thickness (m)</i>
0	0.23	0.19
0.5	0.18	0.15
2.3	0.16	0.099
6.2	0.110	0.069
15	0.092	0.048
28	0.066	0.026
61	0.00	0.00

the bottom of the water column. The predictions in Tables 1 and 2 are much larger than presented in Figure 2 of Appendix 3 because the settling model used too small a settling velocity and too large a plume height. In addition, the predictions in Appendix 3 did not assume any bulking. Considerable bulking will occur because the natural bottom is undisturbed and over-consolidated. The lateral extent of the deposition in Tables 1 and 2 is consistent with the predictions in Appendix 3.

7. Better modeling of the dense jet and the surface discharge from the suction pump could be performed using the D-CORMIX model built for pipeline discharges of dredged materials. D-CORMIX incorporates sedimentation in its mud flow description.

8. It is apparent that the water discharged from the jet discharge and from a suction pump greatly exceeds the ambient flow rate in the near vicinity of the sled. The intake would greatly affect the turbidity plume if the water source were the ambient water in the vicinity. None of the modeling efforts has taken the jet sled water source into account.

9. In summary, I believe that predictions of the turbidity plume are conservatively large due to overestimation of solids entrainment in the water column and neglect of flocculent settling. I believe that the deposition is underestimated by as much as a factor of three due to the use of discrete settling velocity and overestimation of the plume height due to neglect of sedimentation in CORMIX1.

#### 9.4 Status of concerns

The BII responses to the EL concerns addressed most of the questions raised. Additional modeling by EL quantified a reduction in the turbidity plume and an increase in deposition-blanket size associated with BII's

choices of settling velocity and turbidity model. No additional analyses by BII were required to account for these effects. However, Millennium/BII will need to update its results to show as much as a factor-of-three short-term increase in the expected thickness of the sediment blanket adjacent to the pipeline trench.

Additionally, Millennium/BII will need to update the turbidity and sediment-deposition results to account for the ~20% increase in trench depths in zones H-J (Chapter 6) due to the revised 100-year ice scour depths. The sediment blanket thickness and width should each increase by about 10% for a 20% increase in excavated volume (i.e., no change in trench width). The turbidity would increase by 20% if the linear rate of trench production is unchanged. The turbidity should be unchanged if the volumetric rate of production is unchanged. Again, no additional modeling is required to account for a 20% deeper trench.

## 10.0 SUMMARY AND CONCLUSIONS

The Millennium Pipeline Project includes a crossing of Lake Erie to bring Canadian natural gas to markets in eastern United States. Millennium proposes to lay this 1.07-m-diameter, concrete-coated pipeline in a trench excavated in the lakebed to protect it from scouring ice keels, fishing gear, and anchors.

In response to a request from the Federal Energy Regulatory Commission, researchers at ERDC assessed Millennium's work on three topics related to the Lake Erie crossing:

- The potential for pipeline damage by ice scour.
- The adequacy of the sampling program to identify contaminated sediments.

**Table 10.1. Revised 100-year scour depths and design trench depths for Millennium pipeline zones in U.S. waters. Original scour and trench depths are from C-CORE (1999a), although zone definitions differ slightly.**

<i>Pipeline zone</i>	<i>Distance from Canadian landfall (km)</i>	<i>Start–end water depth range (m)</i>	<i>Original 100-year scour depth (m)</i>	<i>Revised 100-year scour depth (m)</i>	<i>Original design trench depth (m)</i>	<i>Revised design trench depth (m)</i>
F	98.0–105.0	21.0–26.7	0.8*	0.8*	2.0	2.0
G	105.0–135.1	26.7–27.4	0.8*	0.8*	2.0	2.0
H	135.1–136.8	27.4–18.4	1.2	1.5	2.8	3.4
I	136.8–142.2	18.4–16.4	1.2	1.5	2.8	3.4
J	142.2–147.3	16.4–17.1	1.2	1.5	2.8	3.4
ALF	147.3–149.3 (DDA)	17.1–8.3				

ALF: American Landfall

DDA : End of Directionally Drilled Pipe from American Landfall

\* Assigned values based on need to protect pipeline from anchors and fishing gear. Ice scour does not control trench depths for zones F and G.

- The adequacy of the modeling for turbidity and sediment deposition resulting from trench excavation.

This assessment focused on the pipeline zones in U.S. waters and was conducted in collaboration with Millennium, its partners, and the Pittsburgh District, Corps of Engineers.

High winds on Lake Erie can fracture and pile ice into large ridges. Ice scour occurs when the keels of these ridges drag along the lakebed. To avoid damage, a pipeline must be designed to withstand the forces from an ice scour expected once in 100 years. The design trench depth must place the pipe crown sufficiently below the scour depth to keep pipe deformations within acceptable limits.

Determination of the 100-year ice scour depth was the only issue that required additional analyses to satisfy the concerns of the ERDC reviewers. The original analyses relied solely on data from a single survey along the pipeline route. The ERDC review resulted in two main changes: only new scours were used to determine the scour-depth probability distribution, and scour data from comprehensive surveys nearby the pipeline route were included. These changes increased the estimated 100-year scour depth by 25%, from 1.2 to 1.5 m, in pipeline zones nearest to the U.S. shore (zones H, I, and J). In these zones the design trench depth increased by about 20%, from 2.8 to 3.4 m (Table 10.1). Ice scour does not control trench depths in deep-water zones F and G, and the originally designed trench depth of 2.0 m is adequate even if it did. Additional benchmark

analyses conducted during the ERDC review increase confidence in the estimated scour rates, the scour-depth distribution, and the resulting 100-year scour depths.

The ERDC review included the pipe–soil interaction model used to determine the design trench depths given the 100-year scour depth for each zone. This finite-element model relies on results from centrifuge tests and field observations, and it represents the state of the art. A question–answer exchange resolved concerns regarding the use of two-dimensional modeling, the choice of soil-stiffness characteristics, and the response of the pipe in a partially backfilled trench. Conservative choices regarding normal incidence angle and keel–pipe load transfer through native soil increase confidence in the model results.

ERDC’s review of Millennium’s sediment-sampling program sought to resolve issues concerning the depth and intensity of sampling and the use of mercury as an indicator contaminant. A question–answer exchange, which included additional data and references, resolved these concerns. No additional sampling or analyses are needed due to increased trench depths because the extra material excavated would be uncontaminated.

ERDC’s review of Millennium’s modeling of turbidity and sediment deposition focused on modeling methods and choice of sediment settling velocity. Many specific issues were resolved through a question–answer exchange. Modeling by ERDC showed that the originally predicted turbidity plume is conservative. However, Millennium will need to update its results to show as much as a factor-of-three short-term increase



in the expected thickness of the sediment blanket adjacent to the pipeline trench. A 20% increase in design trench depths would result in a further 10% increase in blanket thickness and a 10% increase in blanket width. The effect on the turbidity plume would depend on the trench excavation rate. Millennium agreed with the results of this review.

The design of the pipeline includes a margin of safety between the maximum tensile strain caused by the 100-year scour (2.5%) and the strain needed to rupture the pipe (about 3.8%). Millennium will monitor the pipeline continuously for changes in conditions that could signal damage and would close valves at each side of the lake if a leak occurs. In addition, Millennium will conduct internal and external inspections of the pipeline at approximately three-year intervals (depending on ice conditions) to detect possible damage and to assess the design for ice scour protection. It will also establish procedures (as required by regulation) for emergency response and repair of the pipeline.

In conclusion, the ERDC assessment of Millennium Pipeline Project's Lake Erie crossing revealed the need for two revisions: a 20% increase in design trench depths in zones H, I, and J, and as much as a threefold short-term increase in expected sediment-blanket thickness adjacent to the excavated trench. Otherwise, the analyses conducted and reports prepared by Millennium pertaining to the three topics assessed are technically sound and satisfy the request for additional information under the Corps of Engineers regulatory review process.

## LITERATURE CITED

- Andrew Martin** (1999) Letter to U.S. Army Corps of Engineers, Buffalo District. May 10, 1999. Andrew Martin Associates, Inc., Erie, Pennsylvania.
- ASCE** (1984) *Guidelines for the seismic design of oil and gas pipeline systems*. Committee on Gas and Liquid Fuel Lifelines, Technical Council on Lifeline Earthquake Engineering, American Society of Civil Engineers, New York, New York.
- ASME** (1995) *ASME B31.8-1995 edition, Gas transmission and distribution piping systems*. American Society of Mechanical Engineers, New York, New York.
- Assel, R.A., J.E. Janowiak, S. Young, and D. Boyce** (1996) Winter 1994 weather and ice conditions for the Laurentian Great Lakes. *Bulletin of the American Meteorological Society*, Vol. 77, No. 1, p. 71–88.
- Azcue, J.M., F. Rosa, and A. Mudroch** (1996) Distribution of major and trace elements in sediments and pore water of Lake Erie. *Journal of Great Lakes Research*, Vol. 22, p. 389–402.
- C-CORE** (1998) *PRISE—Force models for drained and undrained steady state ice scouring*. C-CORE Publication 98-C33, December 1998, C-CORE, Memorial University of Newfoundland, St. John's, Newfoundland, Canada.
- C-CORE** (1999a) *Lake Erie ice scour/pipeline design, Final report*. C-CORE Publication 98-C34-Final, February 1999, C-CORE, Memorial University of Newfoundland, St. John's, Newfoundland, Canada.
- C-CORE** (1999b) *Comparison of Lake Erie and Northstar pipeline designs for ice scour*. C-CORE Publication 99-C28, September 1999, C-CORE, Memorial University of Newfoundland, St. John's, Newfoundland, Canada.
- CSA** (1999) *CSA Z662-99, Oil and gas pipeline systems*. Canadian Standards Association, Etobicoke, Ontario, Canada.
- CSR** (1998) *TransCanada PipeLines Millennium Pipeline Project Lake Erie Crossing. Volume I: Shallow Hazards Survey Geophysical Program*, Canadian Seabed Research Ltd., Report to MPC International, Inc.
- FERC** (1999) *Millennium pipeline project draft environmental impact statement*. FERC/ESI-0123D, April 1999, Federal Energy Regulatory Commission, Office of Pipeline Regulation, Washington, D.C.
- Fitchko, J.** (1997) *Preliminary Sediment Quality Survey, Millennium Link Lake Erie Crossing*. Geomatics International Inc. Report to Columbia Gas Transmission Corp., St. Clair Pipelines (1996) Ltd. and TransCanada PipeLines Limited.
- Fitchko, J.** (1999) *Comprehensive study report: Environmental impact of the proposed Millennium Project Lake Erie Crossing*. BEAK Ref. 21400.1, BEAK International, Inc., Brampton, Ontario, Canada, February 1999.
- Fredsoe, J.** (1979) Natural backfilling of pipeline trenches. *Journal of Petroleum Technology*, October, p. 1223–1230.
- Grass, J.D.** (1984) Ice scour and ice ridging studies in Lake Erie. In *Proceedings of Ice Symposium 1984, Vol. 2*, International Association for Hydraulic Research, Hamburg (IAHR), F.R. Germany, p. 33–43.
- INTEC** (1998a) Pipelines design basis, Northstar development project detailed engineering. Prepared for BP Exploration (Alaska), Inc., Anchorage, Alaska, INTEC Project H-0660.03, Technical Note TN331, Rev. 1, May 1998.
- INTEC** (1998b) Ice keel protection, Northstar development project detailed engineering. Prepared for BP Exploration (Alaska), Inc., Anchorage, Alaska, INTEC Project H-0660.03, Technical Note TN410, Rev. 3, May 1998.
- Jenne, E.A.** (1977) Trace element sorption by sediments and soil—sites and processes. In *Symposium*

- on Molybdenum in the Environment, Vol. 2, W. Chappell and K. Petersen [Ed.]. New York: Marcel Dekker, p. 425–553.
- Kemp, A.L.W., and R.L. Thomas** (1976) Cultural impact on the geochemistry of the sediments of Lakes Ontario, Erie and Huron. *Geoscience Canada*, Vol. 3, p. 191–207.
- Kemp, A.L.W., G.A. MacInnis, and N.S. Harper** (1977) Sedimentation rates and revised sediment budget for Lake Erie. *Journal of Great Lakes Research*, Vol. 3, p. 221–233.
- Kenny, S., R. Phillips, R.F. McKenna, and J.I. Clark** (2000) Response of Buried Arctic Marine Pipelines to Ice Gouge Events. In *Proceedings, ETCE/OMAE2000 Joint Conference, Energy for the New Millennium, New Orleans, Louisiana*, Paper Number OMAE00-5001.
- Lanan, G.A., A.W. Niedoroda, and W.F. Weeks** (1986) Ice gouge hazard analysis. In *Proceedings of Offshore Technology Conference (OTC)*, Vol. 4, Houston, Texas, p. 57–66.
- Lewis, C.F.M.** (1977) The frequency and magnitude of drift-ice groundings from ice-scour tracks in the Canadian Beaufort Sea. In *Proceedings of Fourth International Conference on Port and Ocean Engineering under Arctic Conditions (POAC)*, St. John's, Newfoundland, Canada, p. 568–579.
- McQuest** (1998) Letter to National Fuel Gas Corporation, July 22, 1998. McQuest Marine Sciences Limited, Burlington, Ontario, Canada.
- MPC** (1997) Millennium Lake Erie crossing preliminary design report, 36-inch gas pipeline. MPC International, Inc., Houston, Texas, prepared for TransCanada Pipelines, Ltd.
- National Fuel** (1999a) Letter to U.S. Army Corps of Engineers, Buffalo District, March 12, 1999. National Fuel Gas Supply Corporation, Buffalo, New York.
- National Fuel** (1999b) Letter to David P. Boergers, Secretary, Federal Energy Regulatory Commission, June 21, 1999. National Fuel Gas Supply Corporation, Buffalo, New York.
- National Fuel** (2000) Letter to U.S. Army Corps of Engineers, Buffalo District, March 31, 2000. National Fuel Gas Supply Corporation, Buffalo, New York.
- Nessim, M., and H. Hong** (1992) Statistical data analysis of new scour characteristics in the Beaufort Sea. Draft Report, Centre for Frontier Engineering Research, Edmonton, Alberta, Canada.
- Niedoroda, A.W.** (1991) Sea ice gouging. In *Handbook of Coastal and Ocean Engineering, Vol. 2: Offshore Structures, Marine Foundations, Sediment Processes and Modeling* (J.B. Herbich, Ed.), Gulf Publishing Co., Houston, Texas, p. 997–1048.
- Nriagu, J.O., A.L.W. Kemp, H.K.T. Wong, and N. Harper** (1979) Sedimentary record of heavy metal pollution in Lake Erie. *Geochimica Cosmochimica Acta*, Vol. 43, p. 247–258.
- Ontario Ministry of the Environment (MOE)** (1979) *Rationale for the Establishment of Ontario's Provincial Water Quality Objectives*.
- Racal Pelagos, Inc.** (1997) *Pipeline Route Survey Lake Erie Gas Pipeline Crossing*, Report to MPC International Inc.
- Robbins, J.A., D.N. Edgington, and A.L.W. Kemp** (1978) Comparative  $^{210}\text{Pb}$ ,  $^{137}\text{Cs}$  and pollen geochronologies of sediments from Lakes Ontario and Erie. *Quaternary Research*, Vol. 10, p. 256–278.
- Tessier, A., D. Fortin, N. Belzile, R.R. DeVitre, and G.G. Leppard** (1996) Metal sorption to diagenetic iron and manganese oxyhydroxides and associated organic matter: Narrowing the gap between field and laboratory measurements. *Geochimica Cosmochimica Acta*, Vol. 60, p. 387–404.
- Thomas, R.L., and A. Mudroch** (1979) Small Craft Harbours—Sediment Survey, Lakes Ontario, Erie and Lake St. Clair 1978: Dredging Summary and Protocol. Report to Small Craft Harbours, Ontario Region, from the Great Lakes Biolimnology Laboratory.
- Thomas, R.L., and J.-M. Jaquet** (1976) Mercury in the surficial sediments of Lake Erie. *Journal of Fisheries Research Board of Canada*, Vol. 33, p. 404–412.
- Weeks, W.F., P.W. Barnes, D.M. Rearic, and E. Reimnitz** (1983) Statistical aspects of ice gouging on the Alaskan Shelf of the Beaufort Sea. USA Cold Regions Research and Engineering Laboratory, CRREL Report 83-21.
- Weeks, W.F., W.B. Tucker, and A.W. Niedoroda** (1985) A numerical simulation of ice gouge formation and infilling on the shelf of the Beaufort Sea. In *Proceedings of Eighth International Conference on Port and Ocean Engineering under Arctic Conditions (POAC), Narssarsuaq, Greenland, Vol. 1*, p. 393–407.
- Wheeler, J.D., and A.T. Wang** (1985) Sea ice gouge statistics. In *Proceedings of Eighth International Conference on Port and Ocean Engineering under Arctic Conditions (POAC), Narssarsuaq, Greenland, Vol. 1*, p. 408–418.
- Woodworth-Lynas, C., D. Nixon, R. Phillips, and A. Palmer** (1996) Subgouge deformations and the security of Arctic marine pipelines. In *Proceedings of Offshore Technology Conference (OTC)*, Houston, Texas, Vol. 4, p. 657–664.

## APPENDIX A: DOCUMENTS REVIEWED

The ERDC team reviewed numerous documents, public comments, and responses to data requests associated with the Millennium Pipeline Project Lake Erie Crossing. Listed here are those documents not specifically cited in the main report.

### LETTERS AND MEMOS

J. Fitchko, Geomatics International Inc., to Scott Hans, USACE Pittsburgh District, 4 June 1997, Reference 15-1617: Lake Erie Crossing sediment sampling program.

J. Fitchko, Geomatics International Inc., to Scott Hans, USACE Pittsburgh District, 31 October 1997, Reference 15-1617: Lake Erie Crossing sediment sampling program.

Haley & Aldrich, Inc., Independence, Ohio, to National Fuel Gas Supply Corporation, June 3, 1999.

Richard E. Hall, Jr., Millennium Pipeline Company, to Gordon P. Buckley, Pennsylvania Department of Environmental Protection (PDEP), December 27, 1999, response to PDEP December 3, 1999 letter request.

Richard E. Hall, Jr., Millennium Pipeline Company, to Gordon P. Buckley, PDEP, January 28, 2000, response to PDEP January 25, 2000 letter request.

Richard D. Haun, OPE Inc., Houston, TX, to Mr. Heino Prah, Attorney representing National Fuel Gas Supply Corporation, Buffalo, NY, June 21, 1999.

Richard R. Hoffmann, FERC Office of Pipeline Regulation, to Margaret Crawford, USACE Buffalo District, July 2, 1999, requesting technical assistance related to Lake Erie Crossing.

Albert H. Rogalla, USACE Pittsburgh District, to Steve Daly, CRREL, requesting technical assistance related to Lake Erie crossing on topics of ice scour, sediment sampling, and turbidity modeling.

### REPORTS

C-CORE (1999) *Lake Erie ice scour/pipeline design, Draft final report - revision A*, C-CORE Publication 98-C34-Rev. A, January 1999, C-CORE, Memorial University of Newfoundland, St. John's, NF, Canada.

CSR (1998) *TransCanada Pipelines Millennium Pipeline Project - Lake Erie Crossing, Volume 1: Shallow hazards survey geophysical program*, contract report submitted to MPC International, November 1998, Canadian Seabed Research, Porters Lake, Nova Scotia, Canada.

**Millennium responses to data requests of OPR/DEER/ERC II**

<i>Data request date</i>	<i>Data request number</i>	<i>Date response filed</i>
March 16, 1998	25	April 6, 1998
October 5, 1998	40, 41	October 20, 1998
July 2, 1999	7, 43, 62, 63, 64, 65	July 21, 1999
July 2, 1999	65-supplemental	July 30, 1999
August 6, 1999	10	August 20, 1999
October 1, 1999	17, 18, 19	October 21, 1999

## APPENDIX B: MPC EMAIL OF MARCH 16, 2000

From: Henry Chang [mailto:hchang@pegasus-international.com]  
Sent: Thursday, March 16, 2000 6:54 PM  
To: 'Ryan Phillips'  
Cc: Jim Babin; 'Peter Patient'; Joe Savoy; Randy Ratterree; Joe Litzelfelner; Henry Chang  
Subject: RE: Location of 1.7m deep scour in lake Erie

The 1.7m ice scour depth is from an Ontario Hydro Ice Scour Study/Report No. 82032 prepared by Mr. J.D. Grass (Jan 15, 1982). For your convenience, here are the excerpts from this report related to the 1.7m scours:

page 4, item 4.2 Field Investigations, paragraph 4: "In summary, field investigations have provided factual records of bottom scours having penetrations less than 0.5m offshore Coho and up to 1.7m offshore Nanticoke. Scour tracks of up to 6km in length and varying in width from a few metres to over 100m are documented."

page 6, item 4.4.3 Sedimentation Rates, paragraph 1: "A maximum sedimentation rate of about 10mm/year has been found in Lake Erie Basin. It follows that if scours deeper than 1.7m have occurred in the past several hundred years, there should be some evidence showing."

The 1.7m scour reference refers to the upper basin of the Lake, which does not affect the pipeline route.

I hope this answers your question.

Regards,  
Randy Ratterree, P.E.

> —Original Message—

> From: Ryan Phillips [mailto:Ryan.Phillips@c-core.ca]  
> Sent: Thursday, March 16, 2000 8:22 AM  
> To: rratterree@pegasus-international.com  
> Subject: FW: Location of 1.7m deep scour in lake Erie

>

>

> —Original Message—

> From: Ryan Phillips [mailto:Ryan.Phillips@c-core.ca]  
> Sent: Thursday, March 16, 2000 10:34 AM  
> To: Randy\_Ratterree@mpcintl.com  
> Cc: Richard McKenna; jfitchko@beak.com; Peter Patient; Rick Hall  
> (Millennium Pipeline); Jim Albitz  
> Subject: Location of 1.7m deep scour in lake Erie

>

>

> Randy,  
> Millenium project and C-CORE representatives attended a meeting with CRREL  
> earlier this week. As you know, CRREL are reviewing our pipeline trench  
> depth recommendations, as part of the FERC review process. CRREL has raised  
> a number of questions of the design ice scour depths along the pipeline  
> route.

- >
- > One of these questions is based on CRREL understanding that there was ‘a
- > 1.7m deep ice scour about 35km south of Port Burwell close to the pipeline
- > route’ based on their interpretation of the statements (below)in the Beak
- > (1997) EA report summarising the MPC report of 1997 (extract below).
- >
- > C-COREs analysis of ice scours in the Lake considered that this 1.7m deep
- > scour was actually one of the scours surveyed by Ontario Hydro near
- > Nanticoke in 15m water depth.
- >
- > Can you please provide MPC understanding (with appropriate references) for
- > the location of the 1.7m deep scour at your earliest convenience. Thanks,
- > Ryan
- >

> =====

- > Ryan Phillips, PEng PhD
- > Geotechnical Director, C-CORE
- > Memorial University of Newfoundland
- > St John’s, A1B 3X5, Canada
- > Tel: 709 737 8371 Fax: 709 737 4706
- > Email: Ryan.Phillips@c-core.ca
- > Web: <http://www.c-core.ca>

> =====

- >
- > Page 9-3 of MPC (October 1997) Preliminary Design Report - 36" Gas Pipeline
- > for TCPL states “Pembina warned of an observed ice scour area in central part of
- > Lake Erie, along Long Point to the southeast side of Port Burwell. In the area of
- > active ice scour, furrows have been observed up to 5.6 feet (1.7m) deep. Ice
- > scour has not been seen at water depths greater than 80 feet (25 meters).
- > Gas well damage due to ice keel was reported in 1979 in 2 areas located
- > about 22 miles (35km) south of Port Burwell..etc”
- >
- > Section 3.8 of the Beak 1997 EA report summarised this information to read
- > “Based on this (Talisman) experience, an ice scour area has been delineated
- > in the central part of the lake along Long Point to the southeast side of
- > Port Burwell (MPC,1997). In this area of active ice scour, furrows have been
- > observed up to 1.7m deep (5.6 ft) in up to 25m (80 ft) water depth. Gas well
- > damage due to ice keel was in reported 1979 in two areas located about 35km
- > (22miles) south of Port Burwell in 25m (80ft) of water depth, but no ice
- > scour was observed in this area...”

**APPENDIX C: LETTER OF SEPTEMBER 22, 1999, FROM TALISMAN ENERGY TO TRANSCANADA TRANSMISSION**

**TALISMAN**  
E N E R G Y

TALISMAN ENERGY INC.  
P.O. BOX 98  
953 ELM STREET  
PORT COLBORNE, ONTARIO L3K 5V7  
FAX (905) 834-4397  
TEL (905) 834-4390  
www.talisman-energy.com

September 22, 1999

**RECEIVED OCT 20 1999**

Trans Canada Transmission,  
801 - 7<sup>th</sup> Avenue S.W.,  
Calgary, Alberta,  
T2P 3P7

ATTENTION: Stephen N. Marr, P.Eng., Manager, Technical Evaluations  
North American Pipeline Investments

Dear Steve,

**RE: HISTORIC ICE DAMAGE, NATURAL GAS FIELDS LAKE ERIE**

In response to your request for details of the pipeline/wellhead damage incurred from ice scouring in Lake Erie, I forward this Talisman lake chart that indicates the known locations of damage along with a brief explanation of what was reported by the divers. Please keep in mind this summary is based on a collection of both documented items and the memory of a few individuals. I apologize for the chart looking like it was completed in a hurry but in all honesty it was. Hope it works.

On the chart the black circles indicate a location where one or more individual items were damaged and the year the damage occurred. Circles shaded in yellow indicate locations where visible evidence of ice scouring was present. I did not include locations in the extreme West End but did throw in a couple that I came across off the Port Colborne area (not sure why). All visible scouring we have experienced has been limited to a maximum depth of 2 feet into lake bottom and has occurred in water depths of less than 60 feet. The majority of these are certainly less for both water depth and trench depth. In only one case was ice scouring visible yet the damage found was to a piece of equipment positioned above lake bottom. All other locations where scouring was evident the damage was to equipment positioned on or slightly below lake bottom. Locations that sustained damage to equipment positioned above the lake bottom level and had no visible signs of scouring are questionable but we are comfortable with assuming ice was the culprit there as well. The lack of marine traffic during the mid to end of winter months certainly points to ice movement. Known anchor damage locations were not included on the chart.

The chart also indicates a couple of locations where we have experienced equipment failures in water depths in excess of 60 feet. In these instances we believe the most likely cause was commercial fish tugs.

continued....

- 2 -

In respect to our 1999 pipeline installation, the only area we took precautions to avoid possible damage from ice movement was at the beach access point. Here the pipeline was positioned in a 4 foot deep trench that extended from the beach water line to a water depth of approximately 30 feet. All remaining portions lay directly on the lake bottom.

Once again, sorry for the hurried appearance of the chart but Peter mentioned in a telephone conversation that this information would be most useful ASAP.

All the best,



Bruce Petrochuk  
Diving/Offshore Operations Superintendent

BP:bm  
atl.

File: Millennium Pipeline  
correspondence #1479  
dtkb35-ice damage review.doc



## APPENDIX D: JIM GRASS EMAIL OF MARCH 30, 2000

From: GRASS James -ELCTRCTY PRD  
[mailto:jim.grass@ontariopowergeneration.com]  
Sent: Thursday, March 30, 2000 1:55 PM  
To: 'Peter Patient'  
Subject: RE: [Fwd: LEC: Possible Ontario Hydro 3.6m deep scour]

Peter

I have report No. 80463 and report No. 81317 (Supplementary to Report No. 80463) in hand. Yes I did say in the report that "In the area of active ice scour and pipeline damage located 20–25 km southeast of Port Burwell scour furrows have been observed up to 3.6 m deep in up to 22 m water depth. Ice scours are generally less than 1 m deep." This was not a confirmed depth and to my memory was a reported depth so it was never included in our data base for our cable design. I did interview gas company staff but as to who said what to whom that information detail is not available. I can't actually say whether the number is correct or not. We did not go into this area of the lake to do any systematic surveys maybe others have done that recently. The 3.6 m seems to be too deep from my experience.

The information provided to you during our discussions were based on real data collected by Ontario Hydro. Confirmed ice Scours and their measured depths (ie measured by OH or others) were the only credible data used for our design criteria. This is why we undertook such an extensive lake bottom survey program. Reported scour depths would not be credible unless measured and to my knowledge this 3.6 m was not. If someone has the backup report for this then I would have to change my mind. I find that sometimes reported depths a somewhat exaggerated or not entirely accurate. The source of this number I cannot say for sure.

It is possible that there is an ice scour out there that is 3.6 m deep that we missed or that has formed since our surveys etc. but I don't know about it for sure. Maybe there is a channel (not a confirmed scour) that is 3.6 m deep out there but where is the backup data.

The information given to you (based on my best knowledge) was based on more refined data collected after this initial report. The knowledge at the time of writing this report was very limited (ie people in the know didn't know how ice ridges formed) and data on ice scours was also very limited.

I do know that based on our measured scour depths that the probability distribution indicated that the probability of exceedance of an ice scour depth greater than 3 m was considered to be extremely low (negligible) and we based our maximum burial depth of 3 m on this analysis. This does not mean that a scour could not be deeper than 3 m but we accepted the risk.

This is the best response I can give at this time. I hope it is satisfactory. Please contact me if you need more help.

Jim Grass

—Original Message—

From: Peter Patient [mailto:peter\_patient@transcanada.com]

Sent: Wednesday, March 29, 2000 12:26 PM  
To: GRASS James -ELCTRCTY PRD  
Subject: [Fwd: LEC: Possible Ontario Hydro 3.6m deep scour]  
Importance: High

Jim,

Any possibility of throwing some light on this? We seem to be getting down to the short strokes with FERC and CRREL on scour depth, but this is a bit of a sticking point. Please acknowledge receipt of this E-mail. Best regards, Peter Patient

