



**US Army Corps
of Engineers®**
Engineer Research and
Development Center

ERDC
INNOVATIVE SOLUTIONS
for a safer, better world

Flood and Coastal Storm Damage Reduction Program

Remote Sensing and Monitoring of Earthen Flood-Control Structures

Joseph B. Dunbar, Gustavo Galan-Comas, Lucas A. Walshire,
Ronald E. Wahl, Donald E. Yule, Maureen K. Corcoran,
Amber L. Bufkin, and Jose L. Llopis

July 2017



The U.S. Army Engineer Research and Development Center (ERDC) solves the nation's toughest engineering and environmental challenges. ERDC develops innovative solutions in civil and military engineering, geospatial sciences, water resources, and environmental sciences for the Army, the Department of Defense, civilian agencies, and our nation's public good. Find out more at www.erdclibrary.usace.army.mil.

To search for other technical reports published by ERDC, visit the ERDC online library at <http://acwc.sdp.sirsi.net/client/default>.

Remote Sensing and Monitoring of Earthen Flood-Control Structures

Joseph B. Dunbar, Gustavo Galan-Comas, Lucas A. Walshire, Ronald E. Wahl,
Donald E. Yule, Maureen K. Corcoran, Amber L. Bufkin, and Jose Llopis

*Geotechnical and Structures Laboratory
U.S. Army Engineer Research and Development Center
3909 Halls Ferry Road
Vicksburg, MS 39180-6199*

Final report

Approved for public release; distribution is unlimited.

Prepared for U.S. Army Corps of Engineers
Washington, DC 20314-1000

Under Work Unit J8D2HJ, "Flood and Coastal Storm Damage Reduction Program
(FCSDR)"

Abstract

The purpose of this study was to identify and review technologies that are applicable in locating weaknesses and poor performance within flood-control structures from extreme loading events. The focus of this study was to assess current technologies and state-of-practice techniques involving remote sensing, testing, and real-time monitoring of earthen structures. Advancements in satellite and sensor technology combined with high-speed Internet and telecommunication capabilities and smart decision-making software permit real-time monitoring of earthen flood-control structures such as dams and levees.

Technologies evaluated included both active and passive sensing methods. These technologies included satellite, airborne, and ground-based sensor systems to identify surface and subsurface characteristics of the watershed, as well as point sensors typically embedded in hydraulic structures to monitor the health of the structure. Point sensors typically record water loading, soil pore pressures, soil movements, and other important properties to evaluate global stability of the water control structure. Geophysical-based methods are typically used in mapping, monitoring, and detection of subsurface stratigraphy, seepage, and any changes in subsurface conditions through time within flood-control structures and their foundations.

DISCLAIMER: The contents of this report are not to be used for advertising, publication, or promotional purposes. Citation of trade names does not constitute an official endorsement or approval of the use of such commercial products. All product names and trademarks cited are the property of their respective owners. The findings of this report are not to be construed as an official Department of the Army position unless so designated by other authorized documents.

DESTROY THIS REPORT WHEN NO LONGER NEEDED. DO NOT RETURN IT TO THE ORIGINATOR.

Contents

Abstract	ii
Figures and Tables	vii
Preface	xiv
Unit Conversion Factors	xv
1 Introduction	1
1.1 Background.....	1
1.2 Purpose and scope.....	1
1.3 Overview of study.....	1
2 Principles of Remote Sensing and Geophysics	6
2.1 Introduction.....	6
2.2 Electromagnetic (EM) radiation	6
2.2.1 EM spectrum	7
2.2.2 Frequency and wavelength	11
2.3 Remote sensing and geophysics	11
2.3.1 Active and passive techniques.....	12
2.3.2 Depth penetration of EM radiation	16
2.4 Resolution in remote sensing	20
2.5 Resolution in geophysics.....	24
2.6 Sources of remote sensing data.....	34
2.7 Sources of geophysical data	38
3 Levee Failure Modes	46
3.1 Introduction.....	46
3.2 Standard levee section.....	47
3.2.1 Definition and history.....	47
3.2.2 Mississippi River example and 1947 Levee Code	48
3.3 Overtopping.....	50
3.3.1 Failure mechanism	50
3.3.2 Remote monitoring and inspection.....	51
3.4 Surface erosion.....	52
3.4.1 Failure mechanism	52
3.4.2 Erosion toolbox.....	53
3.4.3 Remote monitoring and inspection.....	53
3.5 Internal erosion.....	54
3.5.1 Introduction	54
3.5.2 Characteristics of point bars	55
3.5.3 Failure mechanisms.....	57
3.5.4 Remote monitoring and inspection.....	59

3.5.5	<i>Engineering considerations and evaluation factors</i>	60
3.5.6	<i>Remote sensing challenges</i>	65
3.5.7	<i>Importance of LIDAR data</i>	66
3.5.8	<i>Vegetation control and remote sensing applications</i>	67
3.5.9	<i>Thermal IR applications</i>	71
3.5.10	<i>Need for instrumented monitoring</i>	71
3.6	Slope failures	73
3.6.1	<i>Failure mechanisms</i>	73
3.6.2	<i>Legacy levees</i>	74
3.6.3	<i>Geology of foundation slope failures</i>	75
3.6.4	<i>Remote monitoring and inspection of deep failures</i>	78
3.6.5	<i>USACE monitoring examples</i>	78
3.6.6	<i>Shallow type slides</i>	82
3.6.7	<i>Remote monitoring for shallow slides</i>	83
3.6.8	<i>Climate and geology in shallow slide prediction</i>	84
3.6.9	<i>Summary</i>	86
4	Inspection of Flood-Control Works	88
4.1	Introduction and USACE requirements	88
4.2	Civil engineering management program	88
4.3	Levee owner's manual for non-federal flood works	90
4.4	Advances in technologies for FCW inspection and monitoring	101
4.4.1	<i>Introduction</i>	101
4.4.2	<i>UAVs</i>	101
4.5	Thermal imagery and FLIR	103
4.6	Smart phone technology	103
4.7	Flood Risk Management Research Consortium (FRMRC), United Kingdom (UK)	108
5	Instrumentation and Monitoring	116
5.1	Introduction	116
5.2	Instrumentation and monitoring approach	117
5.3	Planning and design	117
5.4	Seismic sensors and measurements	121
5.4.1	<i>Types of sensors</i>	121
5.4.2	<i>Requirement for strong motion instrument</i>	122
5.4.3	<i>Requirement for periodic seismic evaluation</i>	123
5.4.4	<i>Historical earthquake records</i>	123
5.4.5	<i>Remote monitoring and network security</i>	124
5.4.6	<i>Seismicity of levees</i>	125
5.5	Surface deformation sensors	126
5.5.1	<i>Terrestrial Laser Scanning (TLS or Terrestrial LiDAR)</i>	126
5.5.2	<i>Terrestrial Interferometric Synthetic Aperture Radar</i>	127
5.5.3	<i>Total Station (TS)</i>	128
5.5.4	<i>Reflectorless Robotic Total Stations (RRTS)</i>	128
5.5.5	<i>Automated Robotic Total Station (ARTS)</i>	129

5.5.6	<i>Vibrating wire soil extensometer</i>	130
5.5.7	<i>Vibrating wire displacement transducer</i>	131
5.5.8	<i>Tiltmeters</i>	132
5.5.9	<i>Global positioning system (GPS)</i>	133
5.6	Subsurface deformation sensors	134
5.6.1	<i>Inclinometers</i>	134
5.6.2	<i>Vertical methods for measuring subsurface deformations</i>	143
5.6.3	<i>Groundwater pressure and water level measurements</i>	152
5.6.4	<i>Groundwater pressure system installation techniques</i>	166
5.7	Fiber optic monitoring in geotechnical applications	175
5.8	Engineering data from instrument sensors	183
5.9	Remote monitoring and data storage software	185
5.9.1	<i>Introduction</i>	185
5.9.2	<i>Selection considerations</i>	185
5.9.3	<i>Web-based versus desktop software</i>	189
5.9.4	<i>Summary of software considerations</i>	190
5.9.5	<i>WinIDP and DamSmart</i>	191
5.9.6	<i>WebIDP</i>	199
5.9.7	<i>Portal sites</i>	200
5.9.8	<i>Commentaries and limitations on WinIDP/WebIDP and portals</i>	201
5.9.9	<i>Other instrumentation software</i>	203
5.10	iLevee demonstration project	204
5.11	IJkdijk (live dike) test site experiments, Netherlands	210
5.12	Summary	213
6	Noninvasive Methods for Levee and Levee Foundation Investigations	215
6.1	Introduction	215
6.2	Approach	218
6.3	LiDAR	219
6.4	Electromagnetic method	220
6.5	Magnetic surveys	225
6.6	Electrical resistivity surveys	227
6.7	DC resistivity	230
6.8	Capacitively coupled resistivity (CCR)	232
6.9	Seismic methods	234
6.10	Seismic refraction	235
6.11	Seismic reflection	236
6.12	Multi-channel analysis of surface waves (MASW)	238
7	Conclusions and Recommendations	240
	References	242
	Appendix A: Remote Sensing	257
	Appendix B: EP 500-1-1 – Inspection Guide for Flood-Control Works	276

Appendix C: FCW Inspection Guide 286

Report Documentation Page

Figures and Tables

Figures

Figure 2-1. EM radiation is modeled as a sinusoidal wave with orthogonal electrical (E) and magnetic (H) components or fields in the direction of propagation (Campbell 1996).....	7
Figure 2-2. Electromagnetic (EM) spectrum and recognized subdivisions (Sabins 1997). Visible, infrared (IR), and microwave portions are shown in more detail in Figure 2-3.....	8
Figure 2-3. Response of signal propagation through the earth's atmosphere in the visible to microwave regions of the EM spectrum (Sabins 1997).	9
Figure 2-4. Concept of spatial resolution in remote sensing as illustrated by scenes from Harbor Town, Hilton Head, SC, at different pixel sizes (Jensen 2007).	21
Figure 2-5. Resolution requirements and image platforms for different earth science applications (Jensen 2007).	22
Figure 2-6. Concept of depth penetration and resolution in geophysical surveys (Won 2003).	25
Figure 2-7. Example conductivity map in millisemens/meter from helicopter EM survey of Rio Grande levees created by three survey transects along the levee right-of-way (center line and both levee toes with spacing of 50 m between transects).	27
Figure 2-8. Fugro's DIGHEM system for levee mapping consists of five separate transmitters and receivers with frequencies at 102, 25, 9.2, 1.5, and 0.38 kHz (Hodges 2003).	28
Figure 2-9. Conductivity profile or Sengpiel section of an airborne EM survey along a section of the levee toe from San Jaun SE USGS topographic quadrangle in Figure 2-7.	29
Figure 2-10. Example of the results from an 80-m-long resistivity survey of a Rio Grande levee near San Juan, TX (Dunbar et al. 2006).....	33
Figure 2-11. Example of a 45-m-long seismic survey of shear wave velocity of a south Texas levee using the multichannel analysis of surface wave or MASW method.	34
Figure 2-12. Ground penetrating radar suitability map of the United States (http://www.nrcs.usda.gov/Internet/FSE_DOCUMENTS/nrcs142p2_053093.pdf).....	42
Figure 2-13. Ground penetrating radar suitability map of Mississippi (http://www.nrcs.usda.gov/Internet/FSE_DOCUMENTS/nrcs142p2_051841.pdf).....	43
Figure 2-14. GPR suitability map of the Yazoo drainage basin and the relationship of floodplain geology and soils. Brown areas correspond to flood basin/backswamp and tan areas are point bar deposits (http://www.nrcs.usda.gov/Internet/FSE_DOCUMENTS/nrcs142p2_051841.pdf).....	44

Figure 3-1. Mississippi River standard levee section that evolved through time in response to levee performance during following of a major flood event (Moore 1972).....	49
Figure 3-2. Block diagram showing major floodplain environments (Miall 1985; 1996). Environments shown are point bar, flood basin (backswamp), abandoned channels (oxbows), and natural levees (identified as levee in diagram). The upper fine-grained unit is the top stratum, while the lower or coarse-grained unit is the substratum (see boundaries identified by dashed red lines in the block diagram).....	56
Figure 3-3. Seepage through point-bar deposits of thin clay and silt with intervening clay-filled swales (Mansur et al. 1956a, 1956b).....	56
Figure 3-4. Generalized cross section of the geology beneath a levee in a meandering river system (Mansur et al. 1956b).	58
Figure 3-5. Empirical relationship between landside seepage and exit gradient through the top stratum from study of point bar deposits along the Mississippi River (Mansur et al. 1956a).	59
Figure 3-6. Mathematical basis for the analysis of seepage under levees is based on the height of the piezometric surface (h_0) at the toe of the levee and the exit gradient (Sills and Vroman 2005).	63
Figure 3-7. Control and prevention of underseepage in areas with exit gradients of 0.5 and greater at the levee toe (Moore 1972).	63
Figure 3-8. Aerial image of levee reach at Eagle Lake, MS. LiDAR elevation imagery of the same area is shown in Figure 3-9.	68
Figure 3-9. LiDAR image of levee reach at Eagle Lake, MS. Lower elevation correspond to higher intensity purple. Note the ridge (blue) and swale (purple) topography along the levee north of the Eagle Lake oxbow Profile A-A' is presented as Figure 3-10. Note that borrow pits are visible along the flood side of the levee toe, which are potential entry points for seepage.	69
Figure 3-10. LiDAR profile from Figure 3-9 that shows changes in elevation across the ridge and swale topography that is diagnostic of point bar deposits. This variation in elevation can impact levee underseepage and boil activity at the levee toe.....	70
Figure 3-11. Environments of deposition and mechanics of bank failure in Mississippi River alluvial deposits (Krinitzsky 1965).....	77
Figure 3-12. Example profile from the levee flow slide monitoring system in the USACE New Orleans District for determining Mississippi River bank stability (Torrey 1988).....	81
Figure 3-13. Shallow slough slide that is typical in the USACE Vicksburg District (Spencer-Associates 1980): (a) cross section and (b) plan view.	84
Figure 3-14. Map of swelling clays in the United States (Olive et al. 1988).	85
Figure 4-1. USACE Jacksonville District has been working with UAV technology for several years to create high resolution GPS image mosaics and for monitoring their structures and levee systems (USACE 2012c). Also see link at http://www.saj.usace.army.mil/Missions/UnmannedAerialVehicle.aspx for more information.	102

Figure 4-2. FLIR 8500 thermal imaging system onboard Arkansas State Police helicopter used to detect sand boils at Lake Chicot from background seepage by colder temperature during 2011 flooding on the Mississippi River (Woerner 2012).....	104
Figure 4-3. View looking southwest (downstream) during the May 2011 Mississippi River Flood north of Lake Chicot, AR (Eric Woerner, personal communication, Vicksburg District 2012). Light to moderate seepage (see Table 3-1) collecting in the low lying point bar swales. These swales developed as ends of Lake Chicot converged to form an abandoned channel or oxbow of the Mississippi River. The tree line at landside levee toe was site of numerous sand boils (see Figure 4-5 for view of the LiDAR data).....	105
Figure 4-4. MICA Android phone application for reporting seepage incidents to command centers during the May 2011 Mississippi River Flood (USACE 2011b). Example problem area shown in Figure 4-3 and 4.5. The phone app permits communication of written information and integration of GPS imagery to decision-makers.....	106
Figure 4-5. Color and hillshade LiDAR images from upstream of Lake Chicot at Leland Chute showing the point bar ridge and swale topography and relationship to sand boils (noted by yellow circles in images) during 2011 flood. The drainage ditch at the landside toe of the levee was a major problem for sand boil activity at the point bar ridges (sandy areas). Profile A-A' shows the elevation difference between the sandy ridges and low-lying swales. Same area depicted in Figure 4-3.....	107
Figure 5-1. Example 50-cm DEM dataset as hillshade image (left image) from topographic survey using a Riegl LMS Z420i terrestrial laser scanner in a fault study from California (Amos et al. 2013). DEM image shows topographic offset on the Little Lake Fault, California. Geologic map (right image) shows fault trace (red line) and offset in Holocene terrace deposits.....	127
Figure 5-2. Example of data collected with TinSAR (Massanti 2013).....	128
Figure 5-3. Example of remote monitoring of surface deformation using a robotic total station mounted to a building (Tamagnan and Beth 2012).	130
Figure 5-4. Vibrating wire soil extensometer (Geokon 2012).....	131
Figure 5-5. Example of a vibrating wire displacement transducer (Itmsoil 2012).	132
Figure 5-6. Example of a MEMS accelerometer (Guillou 2003).	133
Figure 5-7. Example of continuous GPS monitoring of Tolt Dam (Central Washington University 2013).....	134
Figure 5-8. Photograph of an inclinometer system (DGSI 2009).....	135
Figure 5-9. Schematic drawing showing inclinometer operating principles (Mikkelson 2003).	136
Figure 5-10. Calculation scheme for estimating interval deviation in x-direction (DGSI 2009).	137
Figure 5-11. Presentation of incremental and cumulative displacement plots for inclinometer data (DGSI 2011).....	139
Figure 5-12. Layout for in-place inclinometer (ICE 2012).	140
Figure 5-13. Schematic of ShapeAcelArray (SAA) in-place inclinometer system (Abdoun and Bennett 2008).	141

Figure 5-14. SAA on shipping reel (32 mm) (Abdoun and Bennett 2008).	142
Figure 5-15. Comparison of conventional and SAA in-place inclinometer measurements for an unstable slope at a California test site (Abdoun and Benett 2008).....	143
Figure 5-16. Settlement plate schematic (Dunncliff 1993).....	144
Figure 5-17. Operating principle for fixed borehole extensometer (ICE 2012).....	146
Figure 5-18. Schematic of probe transducer that has a magnetic reed switch (ICE 2012).....	147
Figure 5-19. Cumulative displacement plot of data collected from probe inclinometer with magnetic reed switch (Ridley 2013).	147
Figure 5-20. Setups of open end and closed end installations (DGSi 2006).	149
Figure 5-21. Setup for horizontal inclinometer readings. (DGSi 2004).	149
Figure 5-22. Two-pass procedure for taking conventional inclinometer readings (DGSi 2004).	150
Figure 5-23. Calculation of deviation based on tile angle (DGSi 2004).	150
Figure 5-24. SAA/MEMS inclinometer string on shipping wheel (Barendse 2012).	151
Figure 5-25. SAA/MEMS inclinometer string installation over a wick drain field (Barendse 2012).	151
Figure 5-26. Piezometric groundwater pressures and water stage readings (Garn et al. 2006).....	152
Figure 5-27. Observation well schematic (Dunncliff 1993).	153
Figure 5-28. Water level meter (Scientific Software Group 2013).....	155
Figure 5-29. Open standpipe piezometer schematic (Dunncliff 1993).	155
Figure 5-30. Piezoelectric transducer (Freeman et al. 2004).	157
Figure 5-31. Capacitive transducer (Freeman et al. 2004).	157
Figure 5-32. Inductive transducer shown on the left, reluctance transducer shown on the right (Freeman et al. 2004).....	158
Figure 5-33. Potentiometric transducer (Freeman et al. 2004).....	159
Figure 5-34. Vibrating wire transducer (Freeman et al. 2004).	159
Figure 5-35. Bonded (left) and unbonded (right) (Freeman et al. 2004).	160
Figure 5-36. Fiber optic piezometer (Inaudi and Gilsic 2007a).	161
Figure 5-37. Twin-tube hydraulic piezometer schematic (Dunncliff 1993).	162
Figure 5-38. Flushable piezometer schematic (Dunncliff 2012).....	163
Figure 5-39. Pneumatic piezometer schematic (Dunncliff 1993; 2012).	164
Figure 5-40. Vibrating wire piezometer schematic (Dunncliff 1993; 2012).	165
Figure 5-41. On the left, is an unbonded electrical resistance strain gage schematic. On the right, is a bonded electrical resistance strain gage schematic (Dunncliff 1993).	166
Figure 5-42. Conventional open standpipe piezometer installation shown on the left. Conventional diaphragm piezometer installation shown on the right (Contreras et al. 2007).....	167
Figure 5-43. Fully-grouted borehole (Mikkelsen and Green 2003).	168

Figure 5-44. Push-in open standpipe piezometer (RST Instruments 2013).	168
Figure 5-45. Push-in piezometer shown on left. Schematic of push-in piezometer installation shown on right (Ridley 2013).	169
Figure 5-46. Removable piezometer installation (shown on left figure) and detailed schematic (Ridley 2013).	170
Figure 5-47. Staff gage to measure water levels (USGS 2013).	171
Figure 5-48. Stilling well using float gage to record water levels (Wahl et al. 1995). US Type A-71 float gage with water level recorder shown in the right figure (Rickly Hydrological Co. 2013a).	172
Figure 5-49. Bubbler system: USGS PS-2 pressure sensor system (Rickly Hydrological Co. 2013b).	173
Figure 5-50. Ultrasonic level sensor: EchoSonic II (Flowline 2011).	173
Figure 5-51. Submersible pressure transducer (Freeman et al. 2004 (left); Global Water 2013 (right)).	174
Figure 5-52. Different types of pressure measurement (Freeman et al. 2004).	175
Figure 5-53. Types of fiber optic sensors (Inaudi and Glisic 2007a).	177
Figure 5-54. Basic components of fiber optic cable are (1) high refractive index glass or plastic core, (2) lower refractive index cladding, (3) buffer, and (4) reinforced jacket (Omnisens 2009).	178
Figure 5-55. Components of backscattered light from a single mode laser or single wavelength (Omnisens 2009).	180
Figure 5-56. Idealized diagram showing distributed strain and temperature measurement system for use in levees (Inaudi and Glisic 2007b).	181
Figure 5-57. Dams in Sweden equipped with optical fibers for seepage monitoring for temperature and movements (Sensornet 2012, http://sensornet.co.uk/images/PDF/download95dd.pdf).	183
Figure 5-58. Difference between analog and digital signals from a sensor (Wagner 2013).	184
Figure 5-59. WinIDP/WebIDP architecture (USACE 2012b).	192
Figure 5-60. WinIDP Interface.	195
Figure 5-61. WinIDP workflow (USACE 2012b).	195
Figure 5-62. Merged plots that can be generated using MS Excel and MS Visio (USACE 2012b).	198
Figure 5-63. GDAM Interface in ESRI ArcView/ArcGIS (USACE 2012b).	199
Figure 5-64. WebIDP Interface (USACE 2012b).	200
Figure 5-65. Example project portal site for Bluestone Dam (URS 2013).	201
Figure 5-66. iLevee monitoring demonstration sites (in blue text) by the Louisiana Office of Coastal Protection and Restoration (Brouillette 2012).	205
Figure 5-67. View of Site 5 monitoring system consisting of fiber optic sensor system for monitoring strain displacements at the levee toe and I-wall at the 17th Street Canal in New Orleans for the iLevee monitoring demonstration project (Brouillette 2012).	207

Figure 5-68. iLevee demonstration project at Site 2 on the V-line levee consisting of vibrating wire piezometers and in-place automated inclinometer (Brouillette 2012).....	208
Figure 5-69. iLevee monitoring of T-wall for deflection and foundation movement using tiltmeters and in-place inclinometers at Site 4 on LPV48 levee, east of town of Poydras in St. Bernard Parish (Brouillette 2012).....	208
Figure 5-70. Monitoring at Site 8 at the site of the Hurricane Katrina Mirabeau levee breach on the London Avenue Canal. Monitoring technologies include piezometers in the canal and at levee toe, extensometers, GPS, InSAR reflector (see cross section), and ADAS system to log and transmit data (Brouillette 2012).....	209
Figure 5-71. Aerial view of IJkdijk test facility and the types of levee failure experiments conducted at this site (Koelewijn 2009, 2012).....	211
Figure 5-72. Cross section of the test levee and foundation and the instrumentation incorporated into the IJkdijk loading experiment. (Koelewijn 2009).....	213
Figure 6-1. Illustration of the LiDAR concept.	220
Figure 6-2. An airborne EM survey being conducted showing the towed EM “bird.”	221
Figure 6-3. Vehicle-towed Geonics EM34.....	222
Figure 6-4. Towed EM31 and EM34 apparent conductivity results (Llopis and Simms 2007).....	223
Figure 6-5. Electrical resistivity electrode layout.	229
Figure 6-6. An example of an electrical resistivity cross section 2-D plot.	231
Figure 6-7. Example of results from a 3-D electrical resistivity survey.	231
Figure 6-8. Example of results from a 3-D electrical resistivity survey showing slices taken along the x,y,z planes.	232
Figure 6-9. Illustration of the Geometrics OhmMapper capacitively-coupled resistivity system being vehicle-towed along a levee toe.	233
Figure 6-10. Illustration showing the seismic reflection concept where a seismic disturbance is initiated by a source (S) on the surface and seismic energy reflecting from different layers to receivers (R) located on the ground surface (HQUSACE 1995b).....	237

Tables

Table 2-1. Summary of satellite systems that provide commercial data products.....	13
Table 2-2. Summary of satellite systems based on their spectrum or wavelength bands.....	17
Table 2-3. Common sources for GIS data, aerial photography, and imagery.	35
Table 2-4. Sources of GIS and imagery data by state (after https://lib.stanford.edu/GIS/data).....	36
Table 3-1. Severity of underseepage (Cunny 1987).....	61
Table 4-1. Levee embankments: For use during initial and continuing eligibility inspections of levee segments/systems.	91
Table 4-2. Floodwalls: For use during initial and continuing eligibility inspections of all floodwalls.....	98

Table 4-3. System level surveys using remote data in the UK for flood defense systems (FRMRC 2012).....	109
Table 4-4. Failure mode assessments using remote data in the UK for flood defense systems (FRMRC 2012).....	111
Table 4-5. Detailed inspection and remote monitoring of flood control assets (FRMRC 2012).	113
Table 5-1. Steps in systematic approach to planning monitoring programs using geotechnical instrumentation (ICE 2012).	118
Table 5-2. Traffic light system used to define threshold values.	119
Table 5-3. Instrumentation suggestions (Dunnicliff 1993). (Courtesy of Wiley & Sons. Requests for permissions or further information should be addressed to the Permissions Department, John Wiley & Sons, Inc., 605 Third Avenue, New York, NY, 10158-0012).	120
Table 6-1. Reconnaissance methods.....	218
Table 6-2. Approach to conducting geophysical surveys of levees/dikes (Royet et al. 2012).	219
Table 6-3. Electrical resistivity values of some common rocks and minerals (Keller and Frischknecht 1966).....	228

Preface

This study on Remote Sensing and Monitoring of Earthen Flood-Control Structures was funded by the Flood and Coastal Storm Damage Reduction Program (FCSDR) under the research focus area for Improving Flood Risk Management and Water Control Infrastructure Resiliency and Reliability (WCIRR) under Work Unit No. J8D2HJ.

The work was performed by the Geotechnical Engineering and Geosciences Branch (GEGB) of the Geotechnical and Structures Division (GSD), U.S. Army Engineer Research and Development Center - Geotechnical and Structures Laboratory (ERDC-GSL). At the time of publication, Mr. Chad A. Gartrell was Chief, GEGB; Mr. James L. Davis was Chief, GSD; and Dr. Michael K. Sharp was the Technical Director for Water Resources Infrastructure. Dr. Julie Rosati was the Acting Technical Director of the Coastal and Hydraulics Laboratory (CHL) for the FCSDR Program. The Deputy Director of ERDC-GSL was Dr. William P. Grogan and the Director was Mr. Bartley P. Durst.

COL Bryan S. Green was the Commander of ERDC, and Dr. David W. Pittman was the Director.

Unit Conversion Factors

Multiply	By	To Obtain
feet	0.3048	meters
inches	0.0254	meters
miles (US statute)	1,609.347	meters
pounds (force) per square inch	6.894757	kilopascals

1 Introduction

1.1 Background

Advancements in satellite and sensor technology, combined with high-speed Internet and telecommunication capabilities permit real-time monitoring of earthen flood-control structures, such as dams and levees. The fusion of sensor technology to high speed remote telecommunications capable of large data streams, multiple sensor input, and smart software applications has the potential to greatly advance monitoring and detection capabilities, as well as to sense or perform tests on aging infrastructures to better assess performance under loading conditions. Intelligent-based decision-making software combined with high-speed network and communication capabilities can provide early warnings of distress in flood-control structures and signal when critical trigger points in system loading occurs. Thus, early warning capabilities permit owners and operators of flood-control structures to focus their resources and personnel at critical problem locations during extreme loading events while monitoring conditions and earth characteristics in real-time, leading to potentially adverse events.

1.2 Purpose and scope

The purpose of this study is to identify and review technologies that are applicable in locating weakness and poor performance within earthen hydraulic structures from extreme loading events. The focus of this study is to assess current technologies and state-of-practice involving remote sensing, testing, and real-time monitoring of earthen structures. The first year of this multi-year research effort involves a review of the technical literature to determine the status of appropriate technologies to monitor hydraulic structures both externally and internally. The following report is a literature review of various technologies that are currently being used and/or designed to assess the engineering health of flood-control structures.

1.3 Overview of study

Technology currently exists to perform annual and detailed inspection of flood works using a host of different satellite, airborne, and ground-based platforms and a variety of sensors to monitor both surface and subsurface parameters of interest. The concept of using these different technologies is

explored further in this study along with their application for evaluating failure modes. Another focus of this study, from a U.S. Army Corps of Engineers (USACE) perspective involving ownership responsibility for nearly 12,000 miles of levees and more than 600 dams is to provide information that can be used to improve public safety.

Continuous monitoring of local problem areas is possible with a broad variety of specialized sensors that permit detection of both chemical and physical parameters of interest and changes associated with these parameters through time. The purposes for monitoring are to measure relevant changes in the geotechnical properties during extreme flood events as indicators for system failure, deterioration through time, and/or provide early warning capabilities. In geotechnical applications, parameters of interest in monitoring typically include water elevation, movement of water through soil and rock by seepage, horizontal and vertical displacements, settlements, pressures, stability of slopes, temperature changes, or detection of voids and conduits beneath or within structures.

Technology in use today permits indirect, noncontact methods to detect, monitor, and measure characteristics of a target using electromagnetic energy such as light, heat, and radio waves. Historically, aerial photography was the primary means used to acquire surface characteristics of the watershed, assess properties of river valleys such as floodplain features, surface geology, stratigraphy, topography, vegetation growth, change detection, and other land-use changes. The advent of satellites observing and communicating from space during the past 40 years has given rise to a rapid evolution in remote-sensing capabilities and monitoring possibilities never imagined before. Additionally, these spaceborne advances have occurred in parallel with development of both airborne and ground-based sensors to measure different components of the electromagnetic (EM) spectrum locally. The term remote sensing as used in this report describes the use of different sensors to detect and classify objects on the earth's surface, while geophysics typically involves the study of the earth's interior or subsurface.

Basic principles of the EM spectrum are reviewed in Chapter 2. This spectrum is of central importance in understanding the basic concepts behind the different monitoring and surveillance strategies. The EM spectrum involves a broad range of wavelengths used in remote sensing applications, extending from short wavelengths in the nanometer range to

those that extend many kilometers in length. Different wavelength bands or regions are exploited by various remote sensing technologies in flood control, natural disaster, hazard assessment, and environmental monitoring applications.

Regions of the EM spectrum of interest in geotechnical applications for purposes of remote sensing include the visible, reflected infrared (IR), thermal IR, and microwave portions of the spectrum. The lower region of the spectrum encompassing long wavelength radiation or radio waves has been favored by geophysicists because these wavelengths can penetrate into the earth's surface and provide valuable information on the underlying properties and layering of the soil and rock. Remote sensing applications traditionally favor the use of wavelength for discussion purposes, while geophysical applications normally use frequency for describing the radio transmitter properties in subsurface investigations.

Both remote sensing and geophysical methods are classified as being either active or passive, depending on the source of energy used for making measurements. Active techniques use their own energy, which is typically transmitted by an antenna, coil of wire, or by a pulsed beam of light to the target of interest. Active systems typically include lasers and Light Detection And Ranging (LiDAR) systems in the visible and near IR spectrums, radar in the microwave spectrum, and radio waves for geophysical applications to measure soil conductivity and subsurface layering. Passive techniques in contrast involve sensors that measure only the energy, which is reflected or emitted from the earth's surface. The source of energy in passive techniques is derived from incident solar radiation or sunlight that reacts with the atmosphere, hydrosphere, and lithosphere. Passive-type sensors typically operate in the visible and IR portions of the EM spectrum and comprise the vast majority of remote sensing applications from a historical perspective and past history of use.

Skin depth relationships govern the depth of investigation for any EM radiation, which is dependent on the transmitter wavelength (or frequency), the conductivity of the ground surface, and relevant properties of the transmitter and receiver dipole and associated electronics. Consequently, remote sensing applications using short wavelengths (i.e., high frequency components) typically do not "see" below the ground surface because of the fundamental principles involved. Detection of targets below the ground surface requires long wavelengths (i.e., low frequency or radio wave

spectrum) to measure properties of interest in many earth science and geotechnical applications. Other geophysical techniques used to characterize the subsurface in flood-control applications include magnetism, gravity, or seismic methods.

In addition to the skin depth relationship for EM radiation is the concept of spatial and temporal resolution. The ability to detect the feature or signal of interest by the technology requires multiple pixels or sensors (i.e., electrodes or geophones in the array) to discriminate between features or signals in order to target and identify signs of poor performance. A frequent repeat cycle is needed to characterize changing conditions through time. Monitoring of earthen structures during flooding typically requires high to very high resolution imagery, involving a pixel resolution of 1 m or less, or requires multiple sensors to detect change, and requires hourly to daily repeat cycles. Continuous monitoring is seldom, if ever, achieved for entire flood-control systems except by means of labor-intensive visual inspection combined with detailed knowledge of historic areas where poor performance has occurred. Precision instrumentation and monitoring is needed at those areas where poor performance has occurred in the past to better understand the nature of the problem, which is most often related to a poor understanding or lack of knowledge of the underlying geology.

The evolution of a standard levee section is typical for many flood-control systems in the United States. Standard or legacy levees were built to local performance standards, without the benefit of modern day construction and engineering practices. These systems have evolved through time based on their histories of past performances during multiple flooding cycles. Additionally, these systems have witnessed historic land-use changes that usually reflect a change from an agricultural to an urban protection system, with the central core being composed of the legacy construction. Oftentimes the composition and geotechnical properties of this core are unknown. Levee failure mechanisms are described in Chapter 3 to identify the salient factors involved with the different failure modes. The goal here is to better target remote sensing and monitoring requirements for these applications to identify and detect signs of poor performance.

Current USACE inspection standards are further described in Chapter 4 of this report to highlight the requirements for eligibility for federal damage assistance programs and certification. The goal of this review is to highlight the application of remote sensing and monitoring methods with geographic

information systems (GIS) technology in identifying deficiencies and areas where targeted geotechnical and geophysical studies are needed. The aim should be to supplement the inspection process with these advanced methods, rather than replacing the visual inspection process, which is a critical function for ensuring levee system safety. Periodic assessments of flood-control works using remote sensing methods and incorporating GIS technology should be standard practice for owners and operators of levee systems in the United States for efficient management of floodplain settings. Additionally, the use of smart unmanned aerial vehicles (UAV) technology should be an important component in support of periodic monitoring and assessment.

Chapter 5 includes a review of instrumentation principles and the different types of sensors that are often used to measure both surface and subsurface deformation, settlements, displacements and changes in groundwater conditions. Geotechnical instrumentation in flood-control structures typically measures or monitors water level elevation, groundwater pressure, loading, deformation, total stress in soil, stress changes in rock, and temperature at problem areas where the consequences of failure are intolerable. This information is vital to the design and operation of any flood-control structure when it is used with a thorough understanding of the site geology and the local groundwater conditions. Innovative research involving instrumentation and real-time monitoring of levee test sites is occurring both in the United States and in Europe. These efforts are identified and summarized in Chapter 5 to showcase the technology being used and the primary goals for these studies. These research efforts bear further monitoring to review the results from these experiments and to track important developments in the state-of-practice from lessons learned.

Last, noninvasive geophysical methods are examined in Chapter 6. These methods are for purposes of screening and assessment of large reaches or entire levee systems as part of a system-wide geotechnical evaluation and to characterize local problem areas of interest. Geophysical methods permit continuous monitoring of problem areas, or where early-warning capabilities are needed. Magnetic, electrical, electromagnetic induction, and seismic methods are described in more detail for use in problem area delineation and for continuous monitoring.

2 Principles of Remote Sensing and Geophysics

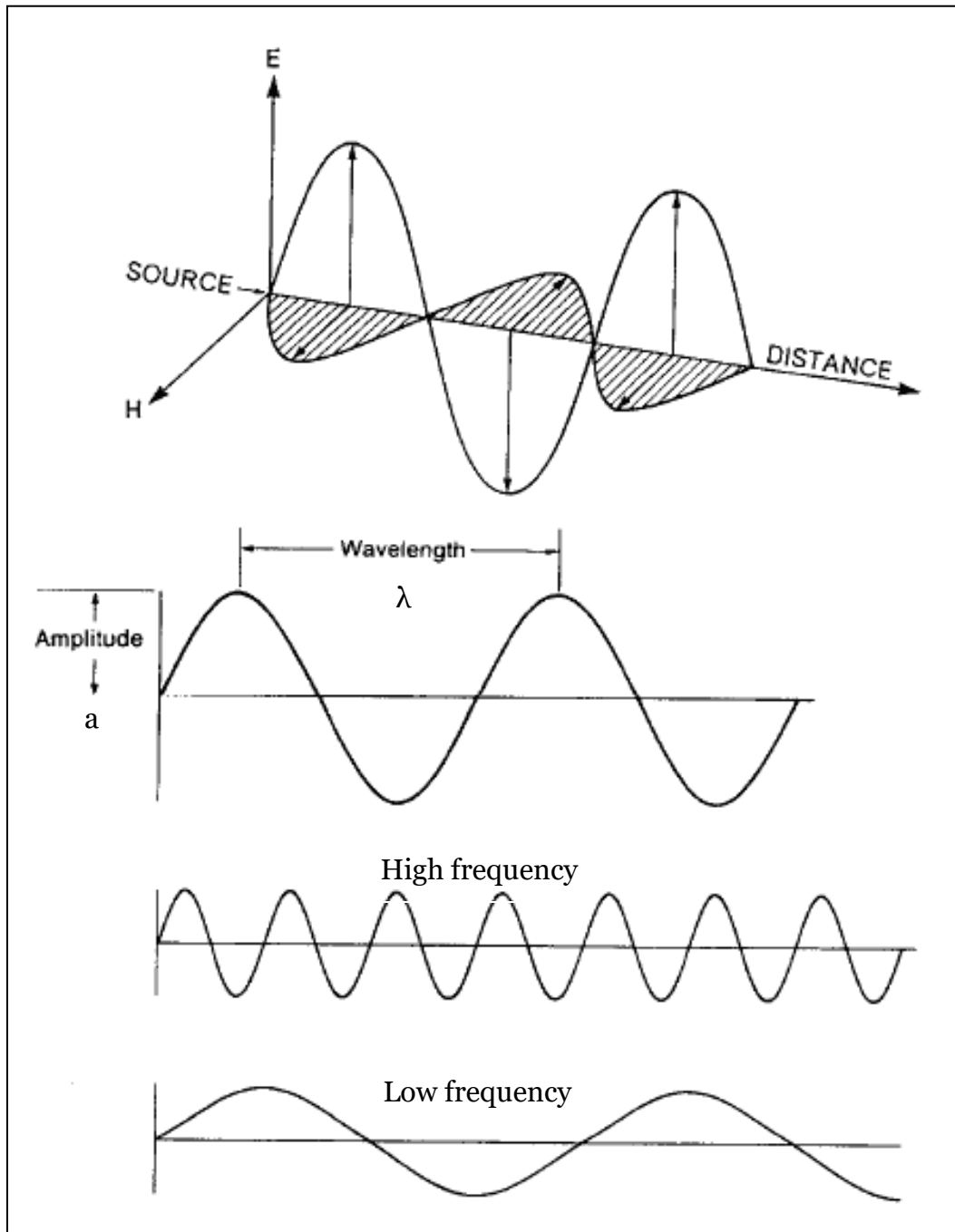
2.1 Introduction

Remote sensing involves indirect, noncontact methods to detect, monitor, and measure characteristics of a target using electromagnetic energy such as light, heat, and radio waves (Sabins 1997). Historically, aerial photography was the primary means used to acquire surface characteristics of the watershed and to assess properties of river valleys including floodplain features, surface geology, stratigraphy, topography, vegetation growth, and land-use changes. The advent of satellites observing and communicating from space during the past 40 years has given rise to a rapid evolution in remote-sensing capabilities along with the development of new sensor types to measure the different components of the EM spectrum. These new satellite and sensor systems permit even greater detection capabilities and resolution than previously imagined possible to accurately characterize and quantify different aspects of the earth's surface. Furthermore, repeat measurements at greater temporal frequencies allow the monitoring of subtle changes that may be occurring and the ability to forecast the rates of change in natural geomorphic and man-made systems. These higher temporal and spatial resolutions improve advanced warning capabilities and increase public safety in flood-protection systems. Basic principles of remote sensing are described in this chapter to provide a foundation for using these technologies in flood monitoring and detection of system distress.

2.2 Electromagnetic (EM) radiation

EM radiation is modeled as a sinusoidal wave (Figure 2-1) with perpendicular electrical (E) and magnetic (H) field components in the direction of wave propagation (Campbell 1996). EM radiation is characterized by three fundamental properties that describe a sinusoidal wave: wavelength (λ), frequency (f), and amplitude (a). Wavelength is the distance between two successive wave crests (Figure 2-1), while the frequency is the number of waves that pass a fixed point in a given time frame or period. Frequency is normally described in terms of the number of cycles per second, and the unit of measure is expressed in terms of hertz. Last, amplitude is the height of each peak in the wave train and corresponds to the energy level of the radiation that is measured or transmitted.

Figure 2-1. EM radiation is modeled as a sinusoidal wave with orthogonal electrical (E) and magnetic (H) components or fields in the direction of propagation (Campbell 1996).



2.2.1 EM spectrum

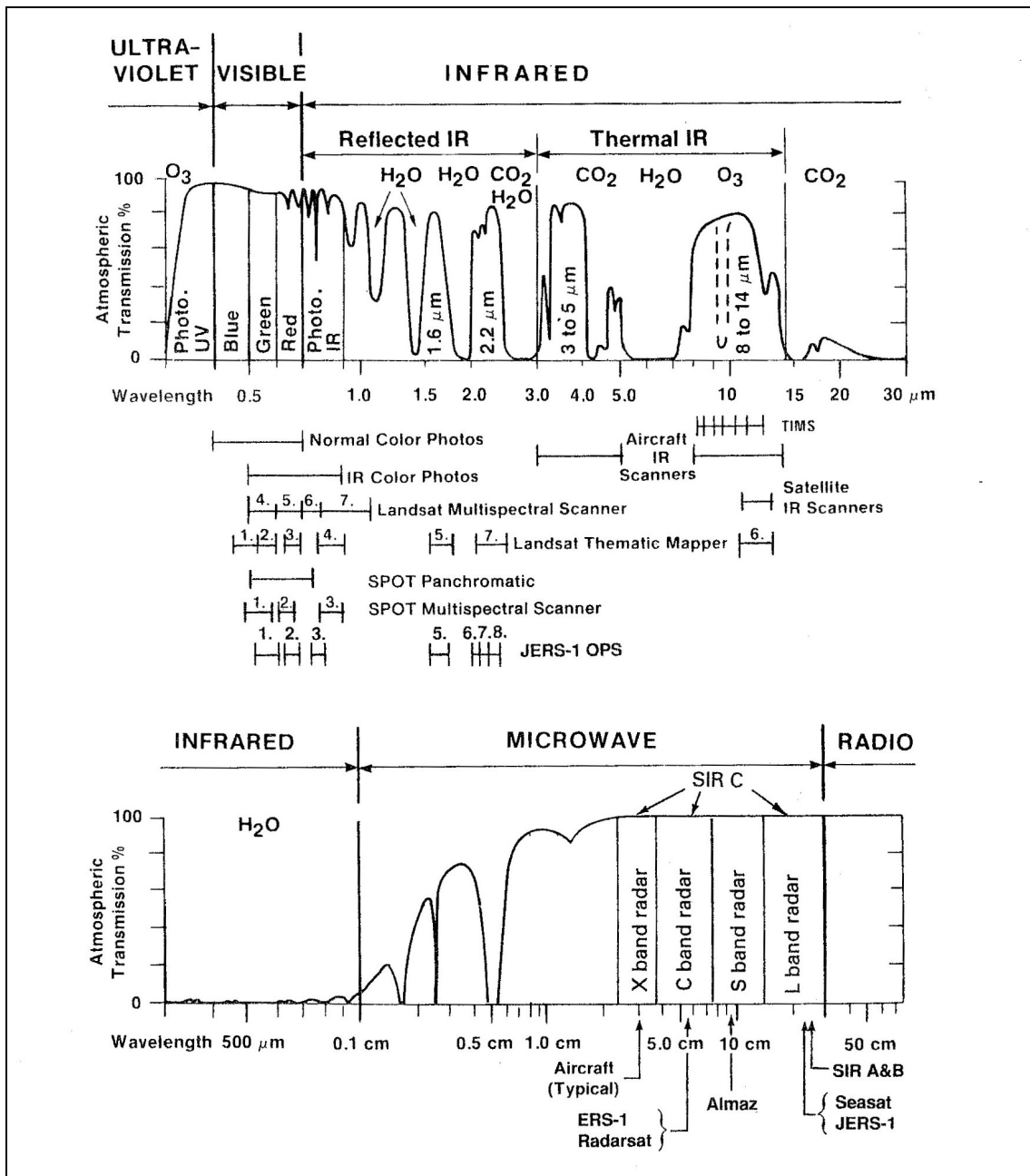
Remote sensing methods are typically classified by the portion of the electromagnetic spectrum used (Figure 2-2). As shown by Figure 2-2, the EM spectrum incorporates a broad range of wavelengths, extending from

very short wavelengths in the nanometer (10^{-9} m) range, to those that extend many kilometers in length. Different wavelength bands or regions are exploited by various remote-sensing technologies in flood control, natural disaster, and environmental applications (Figure 2-3). Regions of the EM spectrum of interest in remote-sensing applications include the visible, reflected infrared (IR), thermal IR, microwave, and radio-wave portions of the spectrum (Figure 2-3). The lower portion of the spectrum with long wavelength radiation is the region of primary interest to geophysicists because this part of the radiation spectrum can penetrate the earth's subsurface and provide information on the underlying material properties and layering.

Figure 2-2. Electromagnetic (EM) spectrum and recognized subdivisions (Sabins 1997). Visible, infrared (IR), and microwave portions are shown in more detail in Figure 2-3.

<i>Region</i>	<i>Wavelength</i>	<i>Remarks</i>
Gamma-ray region	< 0.03 nm	Incoming radiation completely absorbed by the upper atmosphere and not available for remote sensing.
X-ray region	0.03 to 30 nm	Completely absorbed by the atmosphere. Not employed in remote sensing.
Ultraviolet region	0.03 to 0.4 μm	Incoming wavelengths less than 0.3 μm completely absorbed by ozone in the upper atmosphere.
Photographic UV band	0.3 to 0.4 μm	Transmitted through the atmosphere. Detectable with film and photodetectors, but atmospheric scattering is severe.
Visible region	0.4 to 0.7 μm	Imaged with film and photodetectors. Includes reflected energy peak of earth at 0.5 μm .
Infrared region	0.7 to 100 μm	Interaction with matter varies with wavelength. Atmospheric transmission windows are separated by absorption bands.
Reflected IR band	0.7 to 3.0 μm	Reflected solar radiation that contains no information about thermal properties of materials. The interval from 0.7 to 0.9 μm is detectable with film and is called the photographic IR band.
Thermal IR band	3 to 5 μm , 8 to 14 μm	Principal atmospheric windows in the thermal region. Images at these wavelengths are acquired by optical-mechanical scanners and special vidicon systems but not by film.
Microwave region	0.1 to 100 cm	Longer wavelengths that can penetrate clouds, fog, and rain. Images may be acquired in the active or passive mode.
Radar	0.1 to 100 cm	Active form of microwave remote sensing. Radar images are acquired at various wavelength bands.
Radio	>100 cm	Longest-wavelength portion of electromagnetic spectrum.

Figure 2-3. Response of signal propagation through the earth's atmosphere in the visible to microwave regions of the EM spectrum (Sabins 1997).



Terminology, often used to describe or characterize the EM spectrum, remote sensing data products, and basic types of commercial imagery and technology, is briefly summarized here for background purposes and discussion of basic concepts (NGIA 2011):

- **Electro-optical (EO):** technology that records imagery onto digital media acquired by both optical and digital electronic sensors and

- scanners; describes type of image data recorded by these methods, bands, or range of wavelengths commonly used extend from the visible to microwave parts of the spectrum.
- Hyperspectral imagery (HSI): digital data from multiple channels across numerous narrow bands of the EM spectrum (versus broader and less number of bands used in multispectral (MS) or multispectral scanner (MSS) data); spectrum is usually between the visible and thermal IR.
 - Imagery: images recorded onto digital media by use of both electrical and optical (EO) sensors and scanning technology.
 - Infrared (IR): region of spectrum between 0.7 μm (micron or micrometer, 10^{-6} m) to 1 mm and subdivided into reflected IR (0.7 to 3 μm) and thermal IR (3 to 15 μm). Other IR designations include Near IR (0.7 to 1.3 μm), Mid IR (1.3 to 3 μm), and Far IR (7 to 1000 μm or 1 mm).
 - Light Detection And Ranging (LiDAR): sensor technology that uses pulsed laser light in the visible to IR spectrum for measuring distances, for determination of surface topography, and fluoresce for detection of atmospheric constituents.
 - Multispectral (MS): multiple channels across a broad bandwidth between the visible and thermal IR spectrum that are recorded onto digital media by scanning EO technology.
 - Multispectral scanner (MSS): type of multispectral digital data, usually from airborne or spaceborne satellites (e.g., Landsat, SPOT (Système Pour l'Observation de la Terra/System for Earth Observation), Figure 2-3).
 - Panchromatic Imagery (Pan): single-band image containing broad range (visible to near IR) of the EM spectrum and generally displayed as a black and white (B&W) image.
 - Photography: pictures or imagery recorded onto color or B&W film media, generally taken in the visible and photo IR parts of the EM spectrum (Figure 2-3).
 - Synthetic Aperture Radar (SAR): type of sensor and class of data in the microwave region of the EM spectrum that images surface topography in any weather conditions and in either day or night lighting. Microwave spectrum is further subdivided into X, C, S, and L bands (Figure 2-3). Various airborne and spaceborne sensor platforms use different microwave bands and combinations to acquire imagery of the earth's surface for topography and elevation measurements.

In Figure 2-3, well-known remote-sensing systems are identified along with the wavelengths they are sampling. Signal absorption occurs by the atmosphere and water where the EM response is negligible. Different parts of the EM spectrum have typically been used in landscape and land-use mapping, watershed measurements, identifying vegetation, and flood monitoring.

Different components of the EM spectrum and technologies that benefit from the physics involved in monitoring flood-control structures are discussed further in subsequent chapters following a discussion of some fundamental concepts involved in remote sensing.

2.2.2 Frequency and wavelength

The concept of frequency (f) and wavelength (λ) are often used interchangeably in remote-sensing applications because these two variables are related to one another by the simple equation:

$$c = f \lambda \quad (1)$$

where:

c = corresponds to the velocity of the speed of light ($c = 299,893$ km/sec or 186,000 miles/sec).

For any given frequency or wavelength, it is a simple matter to solve for the other variable of interest by this equation. Thus, substituting a value of wavelength into the equation provides the solution for its corresponding frequency.

2.3 Remote sensing and geophysics

The field of remote sensing is fairly broad in scope and incorporates geophysical methods in engineering applications for making indirect measurements to characterize properties of the earth's surface and subsurface. For purposes of this report, remote sensing describes the use of both satellite and airborne sensors to detect and classify objects on the earth's surface, in the atmosphere, and oceans by means of electromagnetic radiation from aircraft or satellites. In contrast, geophysics typically involves the study of the earth's interior (subsurface) using either airborne or ground-based sensors.

Geophysics normally involves making quantitative measurements of the soils and rocks that underlie the earth's surface to determine their composition, structure, or other important properties of the subsurface. These properties usually involve measurements of gravity, magnetic, and electrical fields and/or thermal and seismic properties of the subsurface at areas of interest. Thus, geophysical methods are not solely restricted to sensors that measure only the EM spectrum but incorporate other technologies that measure electrical, magnetic, and gravity fields. Remote-sensing applications traditionally favor the use of wavelength for discussion purposes of the EM spectrum, while geophysical applications normally use frequency for describing the radio transmitter properties in subsurface investigations involving the use of EM radiation.

2.3.1 Active and passive techniques

Remote sensing and geophysical methods are classified as being either active or passive, depending on the source of energy used for taking measurements. Active techniques use their own energy, which is typically transmitted by an antenna, coil of wire, or by a pulsed beam of light to the target of interest. The interaction of this transmitted energy with the surface of the earth is subsequently measured by a sensor or detector at or near the source of the transmitted energy. Active systems typically include systems operating in both the microwave and radio wave portions of the EM spectrum (Figures 2-2 and 2-3). An active technique familiar to most involves the use of pulsed-laser light in the visible and IR spectrum for measuring distance, surface topography, and atmospheric constituents known as LiDAR.

Passive techniques in contrast involve sensors that measure only the energy reflected or emitted from the earth's surface. The source of energy in passive techniques involves incident solar radiation or sunlight that reacts with the atmosphere, hydrosphere, and lithosphere. Passive-type sensor systems typically operate in the visible and IR portions of the EM spectrum, and comprise the vast majority of remote-sensing applications from a historical perspective and the past history of satellite use. Figure 2-3 identifies some of the most familiar satellite systems in commercial use and the regions of the spectrum used by these systems for data collection.

A summary of different satellite systems that provide commercial data products is presented in Table 2-1 and includes salient characteristics about each satellite system (name of system, country of origin, launch

Table 2-1. Summary of satellite systems that provide commercial data products.

Satellite	Country	Active	Resolution	Sampling Rate	Band	Website(s)/Comments
Alos-Palsar	Japan	Launched in 2006	2.5 m, 10 m, 100 m	Subcycle: 2 days	L-band, blue, green, red, near IR, PAN	http://www.satimagingcorp.com/ Satellite Imaging Corporation. 2013. Sensors, Alos
ASTER	United States	Launched in 1999	15 to 90 m	16 days	VNIR: 3 bands, SWIR: 6 bands, TIR: 5	http://www.satimagingcorp.com/satellite-sensors/aster.html ; monitors cloud cover, glaciers, land temps, land-use, natural disasters, sea ice, snow cover, vegetation patterns
CARTOSAT-1	India	Launched in 2005	2.5 m	116 days	X-Band	http://www.satimagingcorp.com/satellite-sensors/aster.html
CBERS-2	Brazil/China joint	Launched in 2003	20 m (nadir)	26 days	Pan, blue, green, red, near infrared	http://www.satimagingcorp.com/satellite-sensors/cbers-2.html ; highest resolution sensor offering a GSD of 20 m at nadir ^a
CosmoSky-Med Constellation	Italy	Launched in 2010	15 m	16 days	X-Band	http://www.e-geos.it/products/cosmo.html
Envisat	Europe	Launched in 2002	25 m	35 days	C-Band	https://earth.esa.int/guest/missions/esa-operational-eo-missions/envisat Secured site, access limited
EO-1	United States	Launched in 2000; Retired in 2009	30 m	16 days	Multispectral	http://eo1.usgs.gov/
ERS1	Europe	Failed in 2000	25 × 25 m	35 days	C-Band	http://earth.esa.int/ers/satconc/
ERS2	Europe	Retired in 2011	25 × 25 m	35 days	C-Band	http://www.esa.int/esaEO/SEMGW2VQUD_index_0_m.html
FORMOSAT-2	Taiwan	Launched in 2004	panchromatic: 2 m; multispectral: 8 m	Daily	Panchromatic, blue, green, red, near IR	http://www.satimagingcorp.com/satellite-sensors/formosat-2.html , http://www.astrium-geo.com/en/160-formosat-2
GeoEye-1	United States	Launched in 2008	panchromatic: 0.41 m; multispectral: 1.65 m	2.1 to 8.3 days	Panchromatic, blue, green, red, Near Infra Red	http://www.satimagingcorp.com/satellite-sensors/geoeeye-1.html
GeoEye-2	United States	Launches in 2013	0.25 m	Daily?	Panchromatic, blue, green, red, Near IR	http://www.satimagingcorp.com/satellite-sensors/geoeeye-2.html ; http://space.skyrocket.de/doc_sdat/geoeeye-2.htm
IKONOS	United States	Launched in 1999	panchromatic: 0.82 m; multispectral: 4 m	Approx. 3 days	Panchromatic, blue, green, red, near IR	http://www.satimagingcorp.com/satellite-sensors/ikonos.html ; http://www.glcf.umd.edu/data/ikonos/ ; http://space.skyrocket.de/doc_sdat/ikonos.htm
Kompsat-1	Korea	Launched in 1999	6 m	28 days	Panchromatic, multispectral	http://earth.esa.int/KOMPSAT/

Satellite	Country	Active	Resolution	Sampling Rate	Band	Website(s)/Comments
LANDSAT 7	United States	Launched in 1999	15 to 90 m	16 days	Panchromatic, thermal IR	http://www.satimagingcorp.com/satellite-sensors/landsat.html ; most accurately calibrated earth satellite
OrbView- 3	United States	Launched in 2003	panchromatic: 1 m; multispectral: 4 m	< 3 days	Panchromatic; multispectral	http://www.orbital.com/newsinfo/publications/ov3_fact.pdf
Pleiades-1	French Guiana	Launched in 2011	0.5 m	Daily	Pan, blue, green, red, near IR	http://www.satimagingcorp.com/satellite-sensors/pleiades-1.html
QuickBird	United States	Launched in 2001	panchromatic: 60 to 70 cm; multispectral: 2.4 to 2.8 m	1 to 3.5 days depending on lat at 60 cm res	Green, red, near IR	http://www.satimagingcorp.com/satellite-sensors/quickbird.html ; has largest image size
Radarsat- 1	Canada	Launched in 1995	50 km × 50 km w/r 10 m; 100 km × 100 km w/r 30 m; 500 km × 500 km w/r 100 m	Arctic daily, Canada every 72 hr, Earth every 24 days	C-band (single microwave frequency of 5.3 GHz)	http://www.asc-csa.gc.ca/eng/satellites/radarsat1/
Radarsat- 2	Canada	Launched in 2007	>res. Is 1 m in spotlight mode	Arctic daily, Canada every 72 hr, Earth every 24 days	Polari metric: HH, HV, VV, VH	http://gs.mdacorporation.com/SatelliteData/Radarsat2/Radarsat2.aspx ;
RapidEye	Kazakhstan	Launched in 2008	5 m	Daily (off-nadir); 5.5 days (nadir)	Blue, green, red, red edge, NIR	http://www.satimagingcorp.com/satellite-sensors/rapideye.html
RCM Constellation	Canada	Launches in 2014-15	<1 m to 100 m	2 to 24 days	C-band	http://events.eoportal.org/get_announce.php?an_id=15216
Saocom	Argentina	Launches 2012-13	10 to 100 m	16 days	L-band	http://www.conae.gov.ar/index.php/english/satellite-missions/saocom/introduction
Sentinel 1	Europe	Launches in 2013	swath width of 250 km, g.r. of 5 × 20 m	1 to 3 days	C-band SAR data	http://www.esa.int/esaLP/SEMBRS4KXMF_LPgmes_0.html
Sentinel 2	Europe	Launches in 2013	10 to 60 m	5 days at equator, 2 to 3 days at mid latitudes	4 bands at 10 m, 6 bands at 20 m, 3 bands at 60 m spatial resolution	http://www.esa.int/esaLP/SEMM4T4KXMF_LPgmes_0.html
Sentinel 3	Europe	Launches in 2013	500 m to 1 km	27 days	21 bands (Ku, C-band, visible, shortwave IR, thermal IR)	Benefit for marine environment

Satellite	Country	Active	Resolution	Sampling Rate	Band	Website(s)/Comments
Sentinel 4	Europe	Launches in 2019	0.12 nm to 0.5 nm	≤1 to 4 days over Europe and Africa?	Ultraviolet, visible, near-infrared	Provides info on atmospheric variables
Sentinel 5	Europe	Launches in 2020	0.25 to 1.0 nm	≤1 to 4 days over Europe and Africa?	UV-1, UV-2, VIS, NIR-1, NIR-2, SWIR-1, SWIR-3	Provides info on atmospheric variables
SPOT-5	Guiana	Launched in 2002	Pan: 5 m, MS: 10 m, SWI: 20 m	2 to 3 days	Green, Red, Near IR, Shortwave IR	http://www.satimagingcorp.com/satellite-sensors/spot-5.html ; used for medium scale mapping, urban & rural planning, oil & gas exploration, natural disaster management
TanDEM-X	Germany	Launched in 2010	1 to 16 m	11 days	X-Band	http://www.dlr.de/hr/desktopdefault.aspx/tabid-2317/3669_read-5488/
TerraSAR-X	Germany	Launched in 2007	1.8 m × 3.4 m res (ss 10 km × 5 km)	every 11 days	X-band (wl-31 mm, f-9.6 GHz)	http://www.astrium-geo.com/terrasar-x/
WorldView1	United States	Launched in 2007	0.55 m GSD at Nadir	1.7 days at 1 m GSD or less; 5.9 days at 20 deg off-Nadir or less	Panchromatic	http://www.satimagingcorp.com/satellite-sensors/worldview-1.html
WorldView2	United States	Launched in 2009	Multispectral: 1.8 m GSD at Nadir, 2.4 m GSD at 20 deg off-Nadir	100 min	8 Multispectral: 4 standard colors, 4 new colors: red edge, coastal, yellow, near-IR	http://www.satimagingcorp.com/satellite-sensors/worldview-2.html

^a A point on the celestial sphere directly below the observer, diametrically opposite the zenith.

date, EM spectrum or band, pixel resolution, repeat frequency, and source for additional information). Appendix A presents a brief technical summary of the satellites identified in Table 2-1 and the intended purpose for their data collection mission. The list is not historically comprehensive, but it identifies the common systems that provide commercial data products.

Table 2-2 presents the different satellite systems based on their spectrum or wavelength bands being measured. The listing includes both active and passive detection systems. These different systems typically take advantage of spectral windows where solar radiation is reflected back into the atmosphere, or where heat energy is emitted from the earth's surface. As shown by Figure 2-3, certain regions of the EM spectrum are blocked due to the absorption of the incoming radiation by water and atmospheric gasses (Figure 2-3). These absorption windows also provide valuable information about the earth's surface and are useful for purposes of both land and water mapping or change detection studies of coastal wetland regions, such as in the Louisiana coastal plain, which accounts for nearly 40 percent of our nation's wetland loss.

2.3.2 Depth penetration of EM radiation

Geophysics typically involves active techniques at the radio wave (RF) or low frequency end of the EM spectrum because these wavelengths are able to penetrate into the subsurface of the earth (Figure 2-2). Wavelengths used in these sensor systems typically range from a few meters to hundreds of kilometers in length. Active geophysical techniques measuring EM radiation generally incorporate a transmitter and receiver pair, with the transmitter broadcasting a signal at a specific frequency (or frequencies). Active EM systems can be either satellite, airborne, or ground based in their operation. Satellite-based systems (e.g., SAR) typically measure only the ground surface for determination of elevation and topographic mapping. Airborne EM systems are used for both surface and subsurface mapping applications, while ground-based EM systems are primarily used for geological mapping of the subsurface. EM radiation transmitted by these different active systems will interact with the ground surface or the underlying soils and rocks. The physics behind the measured radiation at the receiver (antenna or coil loop) involves either the energy reflected from the ground surface, reflections from stratigraphic horizons in the subsurface, or the secondary field response of weak magnetic fields created by currents that are induced into the underlying soils by the transmitter signal.

Table 2-2. Summary of satellite systems based on their spectrum or wavelength bands.

Wavelength	Electromagnetic Spectrum	Satellite	Comments
400 to 700 nm	Panchromatic	Alos Palsar, CBERS-1, FORMOSAT-2, Geo-Eye-1, Geo-Eye-2, IKONOS, LANDSAT-7, ORBVVIEW-3, Pleiades-1, WorldView1	Panchromatic film totals the reflective energy between 400 and 700 nanometers. Color film splits this into the three primary colors: Red, Green and Blue where three film layers are sensitive to these energy wavelengths.
10 to 400 nm	Ultraviolet	Sentinel 4, Sentinel 5	
390 to 750 nm	Visible	Aster, Sentinel 2, Sentinel 4, Sentinel 5	
450 to 475 nm	Blue	Alos Palsar, CBERS-1, FORMOSAT-2, Geo-Eye-1, Geo-Eye-2, IKONOS, Pleiades-1, OrbView-3, RapidEye, WorldView2	
495 to 570 nm	Green	Alos Palsar, CBERS-1, FORMOSAT-2, Geo-Eye-1, Geo-Eye-2, IKONOS, Pleiades-1, OrbView-3, RapidEye, Spot 5, WorldView 2	
620 to 750 nm	Red	Alos Palsar, CBERS-1, FORMOSAT-2, Geo-Eye-1, Geo-Eye-2, IKONOS, Pleiades-1, OrbView-3, RapidEye, Spot 5, WorldView 2	
690 to 730 nm	Red Edge	RapidEye	Rapid Eye's satellites are the first commercial satellites to include the Red-Edge band which is sensitive to changes in chlorophyll content.
700 to 1400 nm	Near Infrared	Alos Palsar, Aster, CBERS-1, FORMOSAT-2, Geo-Eye-1, Geo-Eye-2, IKONOS, Pleiades-1, OrbView-3, RapidEye, Sentinel 2, Sentinel 4, Sentinel 5, Spot 5, WorldView 2	
1400 to 3000 nm	Short-Wavelength IR	Aster, Sentinel 2, Sentinel 3, Sentinel 4, Sentinel 5, Spot 5	
3000 nm to 1mm	Mid-Wavelength IR	OrbView-3, WorldView 2	
3000 nm to 1 mm	Long-Wavelength IR	Aster, LANDSAT 7, OrbView- 3, Sentinel 3, WorldView 2	
1.67 to 2.4 cm	Ku-Band	Sentinel 3	
2.4 to 3.75 cm	X-Band	CARTOSAT-1, Cosmo-Sky Med Constellation, Tandem-X, TerraSAR-X	
3.75 to 7.5 cm	C-Band	Envisat, ERS1, ERS2, Radarsat 1, Radarsat 2, RCM Constellation, Sentinel 1, Sentinel 3	
10 cm	S- Band	Almaz, Radarsat- 1, RapidEye	
15 to 30 cm	L- Band	Alos-Palsar, JERS- 1, Saocom	

SAR is an active geophysical technique that detects reflections from pulsed EM energy interacting with the ground surface, while ground penetrating radar (GPR) measures the energy reflected from contrasting stratigraphic horizons (with differing electrical properties) in the subsurface. In GPR surveys, a high frequency electromagnetic pulse in the megahertz (MHz) or microwave frequency range is transmitted into the ground by a radar antenna that is coupled to the ground to image the subsurface for variations in soil and stratigraphy. A contrast in the electrical properties of underlying horizons must occur for the radar receiver to detect a change in the underlying material. Differences in the electric properties of the media influence the propagation, attenuation, and reflection of radar waves in the subsurface (Reynolds 2011).

Induction techniques in EM surveys measure the decay of weak currents induced into the soils by the system transmitter. These weak currents in turn produce secondary magnetic fields and are measured as voltages at the receiver coil. The amplitude and phase lag of the voltage in the receiver coil, in comparison to the primary signal, typically relates to the electrical properties or conductivity of the shallow subsurface soils. The measured signal from the secondary field is normally in parts per thousand (ppt) of the primary signal in ground-based systems, and parts per million (ppm) in airborne systems that employ active EM induction techniques.

EM induction techniques can operate in either a time-domain or frequency mode. Time-domain techniques involve measuring the time decay of an RF signal after the transmitter is turned off, with the signal decay properties being a function of the electrical properties of the underlying soils and stratigraphy. In contrast, frequency domain techniques broadcast a continuous sinusoidal wave. Both types of techniques measure, at the receiver coil, the interaction of weak currents that are produced in the subsurface by the transmitted signal. EM induction techniques in studies of levees are commonly used to map the conductivity or resistivity of the underlying soils, determine the site stratigraphy, identify major geologic features (e.g., bedrock), and/or detect anomalies such as voids, utilities, and other man-made structures.

The depth of investigation from EM radiation is dependent on the skin depth (δ), or the depth at which the amplitude of the transmitted signal is reduced to $1/e$ or 37 percent of its original value in the ground (Reynolds 2011). The “skin depth” is considered to be the realistic point below the

ground surface to which the transmitted signal is effectively able to penetrate or “see” into the subsurface. This point is taken as the practical limit of the signal propagation into the subsurface by any EM signal, whether it is transmitted from a satellite, aircraft, or by a ground-based system. The attenuation of the EM signal with depth vertically downward is a function of the conductivity (σ) or resistivity (ρ) of the underlying half-space (i.e., zone below the ground surface), the angular frequency ($\omega = 2\pi f$) of the transmitted signal, and the magnetic permeability of free space (μ_0). Skin depth (δ) at a particular frequency and conductivity or resistivity can be determined from the following expression (Sharma 1986):

$$\delta = (2 / \sigma \omega \mu_0)^{1/2} = 503.8 / (\sigma f)^{1/2} = 503.8 (\rho / f)^{1/2} \quad (2)$$

The concept of skin depth is an important consideration in any study involving EM radiation in both remote-sensing and geophysical applications. The purpose for conducting the study should consider what techniques are suitable for resolving the feature of interest, and whether the data acquired are intended to identify and classify features on the earth’s surface, or look below the ground surface and into the subsurface. The latter consideration directly involves the skin depth of the radiation and what are the target depths of interest. Short wavelength EM radiation (Figure 2-3) in remote sensing applications cannot penetrate into the subsurface. The small wavelengths and the signal attenuation by the surface soils limit their ability to “see” into the subsurface. Skin-depth principles govern the practical use of the EM spectrum in both satellite and remote-sensing applications. The physics of EM radiation propagation affects ground, air, and satellite-borne techniques equally.

As an example, a major obstacle to depth penetration by radar techniques is the influence of the soil conductivity, which is directly dependent on particle grain-size and soil moisture. Loss of signal strength in radar surveys occurs by geometrical spreading, attenuation of energy by the soil, and scattering. In highly conductive soils, the transmitted signal is rapidly attenuated, which results in low or minimal depth penetration of the signal, and corresponding loss of resolution of any subsurface features. Thus, both GPR and SAR systems are severely limited in their ability to penetrate to any great depth into the subsurface because of highly conductive soils and/or wet soil conditions. In contrast, dry sands are more resistive and permit deeper penetration of signal. As an example, mapping of ancient river courses in the Sahara Desert was possible with

SAR techniques because of the coarse texture of the soils and the dry conditions, which produced resistive conditions in the underlying soils (Elachi 1983).

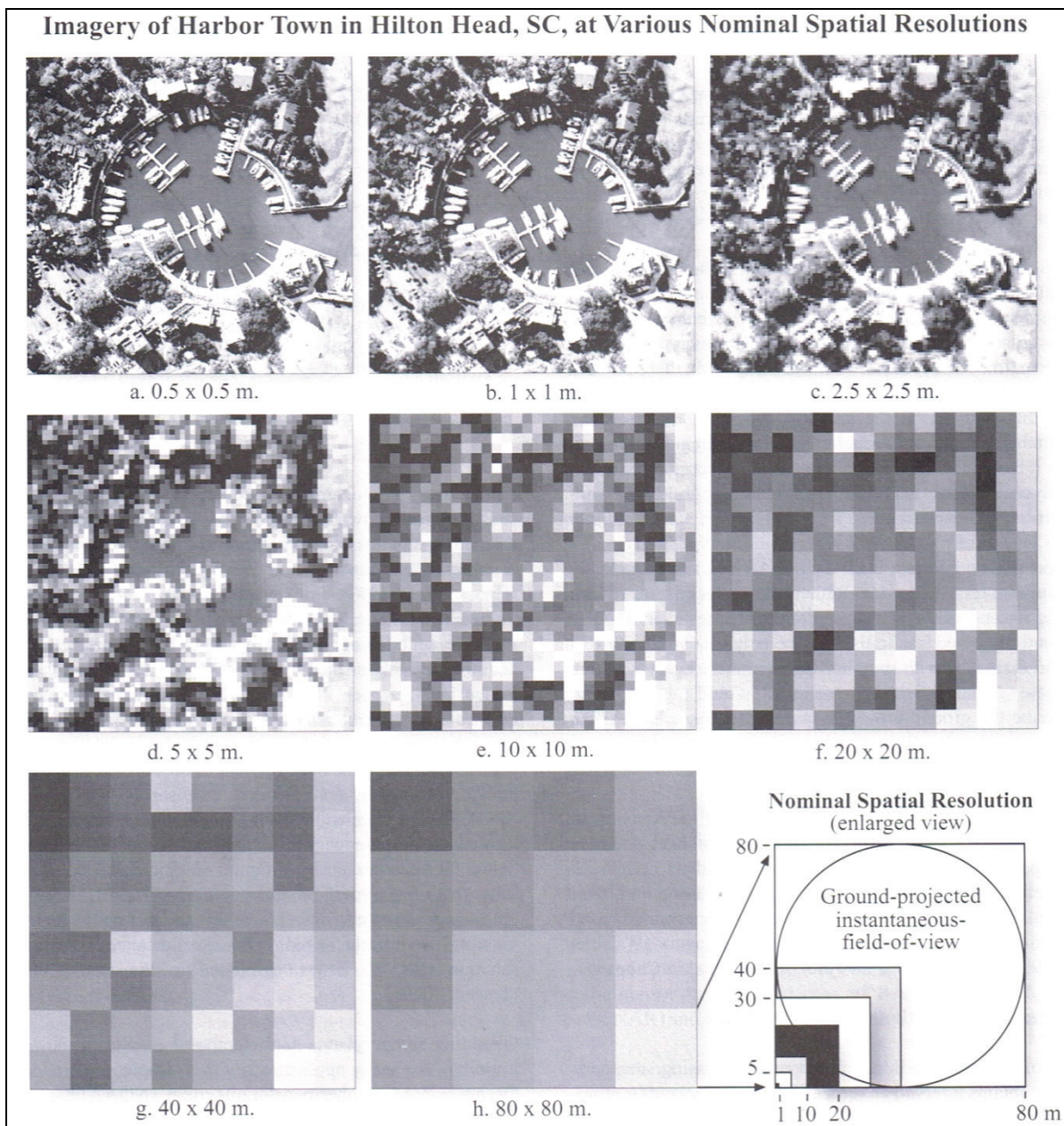
In summary, the physics of the sampling method (active or passive), transmitter frequency, ground conductivity, and EM skin-depth relationships govern the effective depth of penetration for the sample techniques. The ability to detect and discriminate targets at the surface or in the subsurface is a fundamental consideration of many studies of flood-control systems. If the intended purpose is to measure and monitor surface features, then a wide variety of satellite, airborne, and ground-based systems exist. If the intent is to detect features in the subsurface, then the region of the EM spectrum to be used is limited to mainly the RF part of the spectrum and primarily airborne and ground-based systems.

2.4 Resolution in remote sensing

Resolution in remote sensing and geophysics applications is a measure of the ability to distinguish detail and resolve closely spaced targets (Bates and Jackson 1980). Resolution is a measure of the minimum-sized feature that can be detected using remote sensing or geophysical techniques. Resolution has fundamentally different principles for remote sensing applications as compared to those involving geophysical techniques.

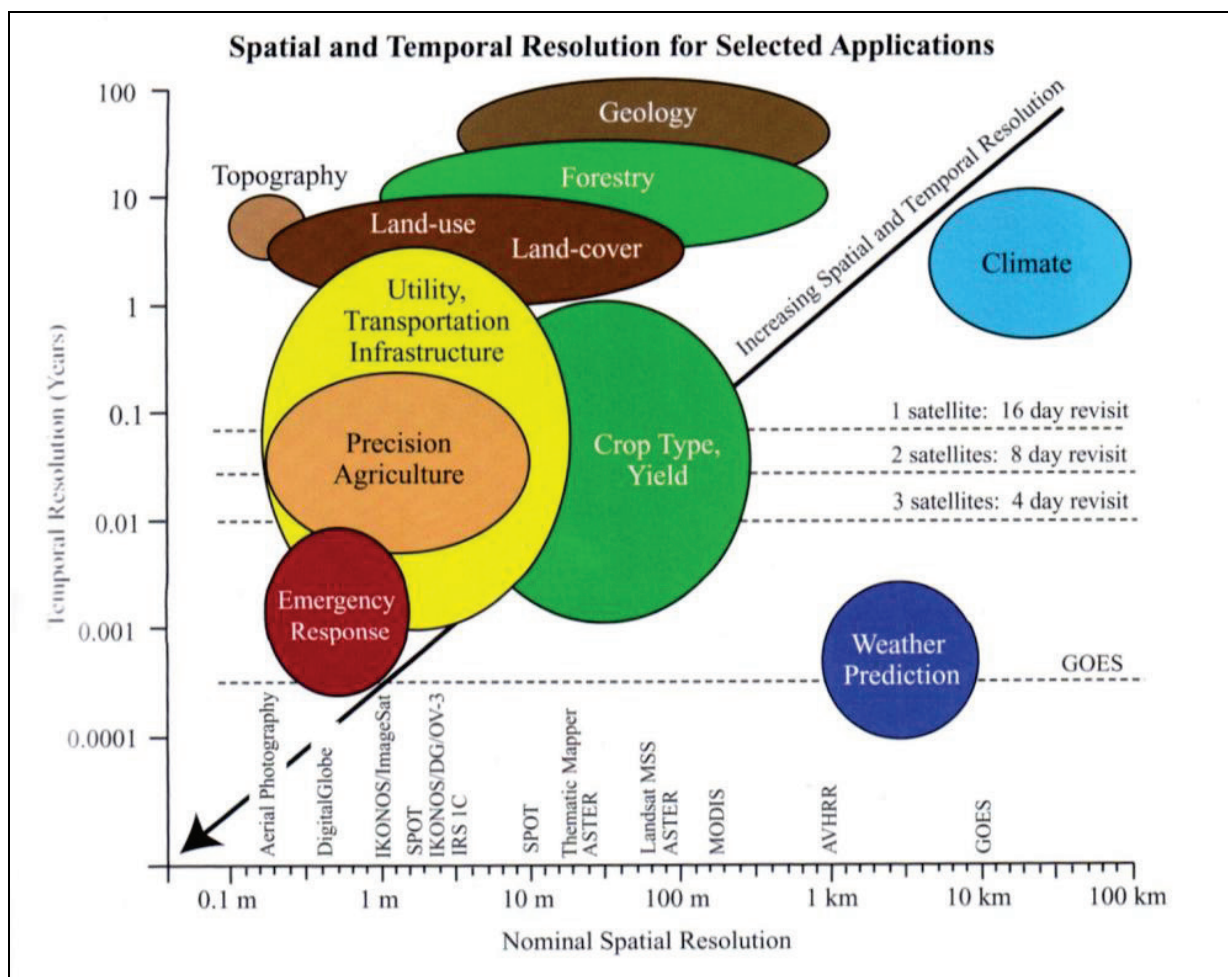
In terms of remote sensing, resolution involves both the spectral properties and the spatial definition needed to measure and identify features on the earth's surface. Spectral content refers to the wavelength position, the bandwidth range, and the number of spectral bands required to distinguish objects, while image resolution is a measure of the smallest feature that can be identified and measured in terms of the number of pixels needed to characterize objects in the image. A pixel, or picture element, is the smallest raster element that comprises an image. Spatial resolution is often identified in terms of the size or the dimension of an individual pixel in the image. A high resolution image requires numerous pixels to define a feature of interest (Figure 2-4). Regional studies involving evaluations of entire watersheds and drainage basins may be more appropriate with medium to low resolution images (middle and bottom rows in Figure 2-4, respectively) where identification of smaller features are not as important.

Figure 2-4. Concept of spatial resolution in remote sensing as illustrated by scenes from Harbor Town, Hilton Head, SC, at different pixel sizes (Jensen 2007).



The purpose for the study will often govern the resolution requirements for the image data. Requirements may involve the choice of the sensor, the wavelength interval, the number of bands to be used, and the repeat frequency of the collection cycle. Identified in Figure 2-5 are both spatial and temporal resolutions for various technical applications, including land-use, disaster response and monitoring, science, agriculture, climate, and weather. Many applications require only periodic repeat cycles at time scales of 1 to 3 years and at a low pixel resolution of 30 m or greater.

Figure 2-5. Resolution requirements and image platforms for different earth science applications (Jensen 2007).



Studies involving a large area, such as parts of states or multistate applications encompassing regional watersheds where a high level of resolution is not needed, can be addressed with data from this category. These studies range from broad land cover assessments, determination of agriculture and crop yields, forestry and geology mapping, to climate and weather monitoring (Figure 2-5). Flood monitoring of earthen structures requires both image and temporal resolutions at the low end of the measurement scale, involving 1 m or less image resolution of problem areas and daily or hourly repeat cycles. Common data types involved in these regional studies are typically digital in nature and involve U.S. Geological Survey (USGS) topographic maps (digital raster graphics, DRGs), digital-ortho-quarter-quadrangles (DOQQ, digital image corresponding to one-quarter of a standard 7-1/2-min USGS topographic), and digital elevation models (DEMs).

At the highest level of data fidelity are studies requiring a pixel resolution of less than 5 m. Typically, engineering and emergency response applications require image resolution of 1 m or greater. The frequency of the data collection is dependent on the type problem to be solved and the sensor platform needed to address the problem (Table 2-1). A major focus of this overall study involves monitoring of flood-control structures, flood-fight applications, and detection of poor performance in flood-control and engineering structures. Thus, this focus requires a high degree of spatial resolution and temporal repeat frequency to ensure that real-time monitoring is possible during a flood event.

The detection of sand boils behind levees during a flood event serves as an example of the use of high resolution imagery and the need for high frequency inspection requirements. Formation and progression of sand boils at the levee toe during a flood event are major concerns to levee integrity and can cause a levee to breach without flood-fight intervention. Sand bag rings are often used to contain the boil during the flood event area by raising and controlling the height of the phreatic surface and limiting the flow velocity at the levee toe to prevent the loss of foundation material due to excessive hydrostatic pressures in the foundation. The loss of levee and foundation materials due to piping is a major failure mechanism that can cause a levee to breach. These features typically begin as pin boils at the levee toe and can progress in size through time, leading to the formation of a “pipe” under the levee or through the levee embankment to the source of the flood waters. Sand boils can become progressively larger in scale, especially over multiple flood cycles, and require active remediation during flooding to prevent the loss of the levee section. Relief wells relieve pressure in the substrate through screened well points that prevent loss of material without controlling the exit velocity. While both sand bags and relief wells are methods aimed at controlling piping, they are fundamentally different approaches that are not analogous. Sandbagging reduces the exit velocity, and hence, the carrying capacity of the flow by decreasing the hydrostatic head.

Spaceborne satellite technology is severely limited in the detection of small sand boil features at the current time because of the image resolution needed for boil detection, the repeat frequency, and the 24-hr monitoring cycle necessary to conduct effective flood fighting operations. Airborne monitoring techniques permit higher spatial resolutions and allow for more frequent and targeted inspections in flood fight situations. Promising

airborne remote sensing techniques to identify and monitor boil formation involve the use of thermal techniques to differentiate water temperature of boils from heavy seepage areas behind levees. These techniques will be presented in the next chapter of this study. However, the discussion of resolution is continued to address geophysical considerations involving subsurface investigations.

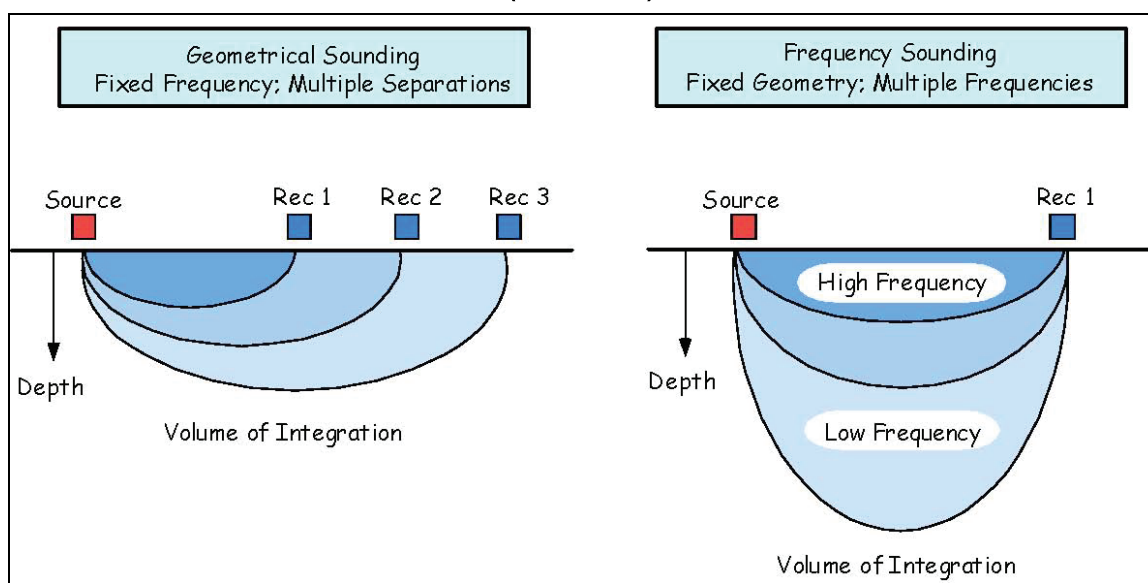
2.5 Resolution in geophysics

Resolution in geophysical applications has unique characteristics beyond those associated with remote sensing techniques because of the subsurface component. The primary goal of geophysical surveys in flood-control studies is identifying anomalous subsurface features. Features, such as soil type, man-made conduits, stratigraphic and geologic boundaries, can create seepage problems in the levee embankment or the foundation. Geophysical surveys also seek to define both textural and density contrasts of the subsurface soils to characterize their material properties for engineering applications. Because of the ability to image the subsurface and provide added value for engineering studies, various types of geophysical methods are typically employed including electrical resistivity, EM induction, GPR, magnetometer, and seismic surveys. Resolution is briefly described in this section as it applies to various geophysical methods and requires a review of some basic concepts and sampling principles employed by these methods. This discussion is by no means comprehensive, but it does provide a basic understanding of the issues involved.

Sampling strategies using electrical (primarily resistivity) and seismic methods normally involve trade-offs between the sensor spacing in the array and the length of the sensor array over the target or feature of interest. Wider sensor spacing and longer sensor arrays are typically employed to image to greater depths of investigation. The use of evenly-spaced sensors coupled to the ground, whether in electrical resistivity or seismic surveys, typically involves a high resolution spacing of sensors on the order of 2 m or less, while wider or coarser configurations typically involving spacings of 5 to 10 m or greater. Changes in the sensor spacing to image targets at increasing depths of investigation classify as a *geometrical sounding* technique (Figure 2-6). Resolution involves both the volume of integration (volume of material being measured) and the spacing between measurements points. Increasing the spacing of the sensors (geometrical sounding in left illustration) is analogous to changing the transmitter frequency as shown in Figure 2-6. The principle of geometrical sounding applies to

electrodes used in resistivity surveys with current and potential electrodes, their spacing (known as “a-spacing”), and the type of sounding techniques used (e.g., dipole-dipole, Schlumberger). Seismic techniques involve the same basic principle of source and geophone spacing and expanding the length of the array (number of sensors) to image deeper along the survey line. In frequency sounding, the basic principle applies to EM and GPR surveys. Transmitter and receiver spacing and the transmitter frequency governs the depth of penetration into the subsurface. A general rule of thumb often used in frequency sounding surveys is that the volume integration is one-half of the dipole length (where the dipole length is transmitter and receiver spacing) and the maximum depth possible is governed by the skin-depth equation described in the text.

Figure 2-6. Concept of depth penetration and resolution in geophysical surveys (Won 2003).



A general rule involving sensor spacing in terms of target resolution is for the sensor spacing to be at a minimum between one-quarter and one-half the size of the feature of interest. The intent is for the target to be detected by multiple sensors in the linear array. A wider spacing between the individual sensors involves a larger volume of earth that is sampled and measured. It is desirable to have a signal from the target that is separate from the surrounding matrix and can be readily measured to separate the target from the matrix. A longer sensor array and spacing between sensors result in an increased volume of earth being sampled, with a corresponding coarser resolution, but permits much deeper penetration into the subsurface. The geometrical spacing concept is somewhat analogous to

increases or decreases in pixel resolution using remote-sensing methods, with a minimum number of pixels required to adequately define and image the feature of interest at the surface, except this principle applies to imaging in the subsurface.

The use of both multiple and decreasing frequencies by a dipole transmitter-receiver system is comparable to the geometrical sounding principle. Instead of multiple sensors at equally spaced distances and longer arrays, multiple frequencies are used for sounding along the survey line. The use of multiple frequencies by a dipole (transmitter-receiver) system is known as a *frequency sounding* technique (Figure 2-6). The use of multiple frequencies at a given measurement point is needed to map the distribution of conductivity or resistivity with depth and provide valuable information about the underlying soils and stratigraphy.

Historically in engineering applications, values of conductivity are used, while in the mining and mineral exploration industry, resistivity values are reported. McNeill (1980) prefers the use of conductivity (σ) with inductive techniques because the response is generally proportional to conductivity, and inversely proportional to resistivity (ρ). However, the specific values used are a matter of preference, as it is a simple matter to convert between the two units ($\sigma = 1/\rho$).

Frequency sounding methods operate under similar rules as those for geometric sounding. The dipole length (transmitter-receiver spacing) and changes in frequency affect the target resolution and the depth of investigation. Lowering the transmitter frequency permits deeper penetration by the skin depth rule described earlier. An increase in the dipole length at the measurement point is analogous to the increase in electrode spacing in electrical resistivity surveys. Thus, longer dipole length permits a greater volume of the subsurface to be sampled (Figure 2-6). Ground-based EMI systems can have dipole lengths of 30 to 40 m (~100 to 131 ft), which is common for the Geonics EM-34. This instrument has multiple dipole lengths of 10, 20, and 40 m, with lower transmitter frequencies at each longer dipole spacing, and increased power levels by the transmitter as the dipole length increases.

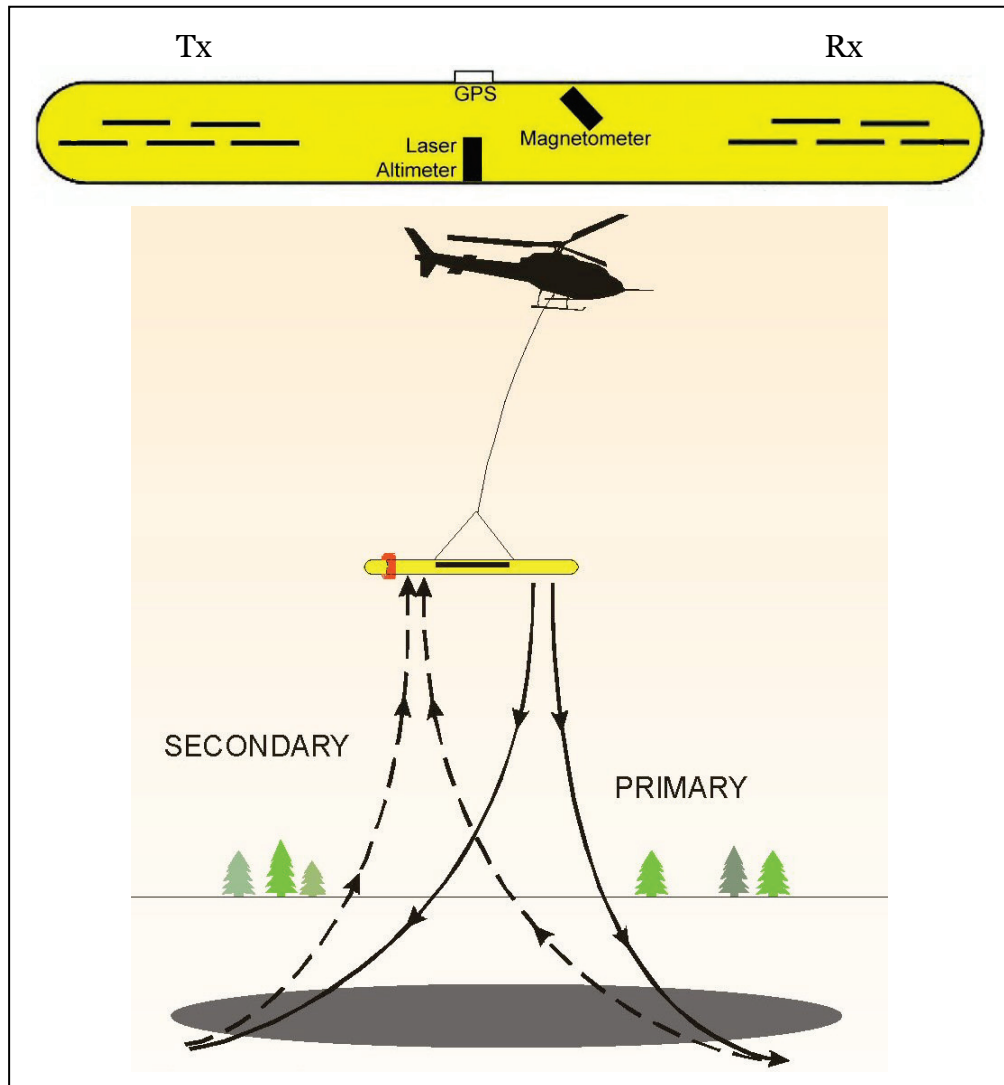
The measurement point for ground-based EMI instruments is usually taken at the midpoint of the dipole. This is comparable to the standard practice in resistivity and seismic surveys, which is to use the midpoint of the sensor

and source configuration. Sampling at a fixed spacing along a survey line and wider spacing between the individual sampling points permits a vertical profile of the parameter being measured, such as conductivity, magnetic intensity, or seismic velocity. The concept of a vertical profile provides valuable information about the distribution of the underlying soils and stratigraphy along the survey line. Multiple survey lines that are offset from each other by a fixed interval permits delineation of buried features over the region of interest. Multiple survey lines permit the development of a three-dimensional (3-D) map of the subsurface (Figure 2-7). The survey area shown in Figure 2-7 corresponds to a 7-1/2 min USGS DRG of the San Juan South East topographic quadrangle. Survey data were obtained with the DIGHEM airborne EM system by Fugro Airborne Surveys in 2001 (Figure 2-8).

Figure 2-7. Example conductivity map in millisemens/meter from helicopter EM survey of Rio Grande levees created by three survey transects along the levee right-of-way (center line and both levee toes with spacing of 50 m between transects).

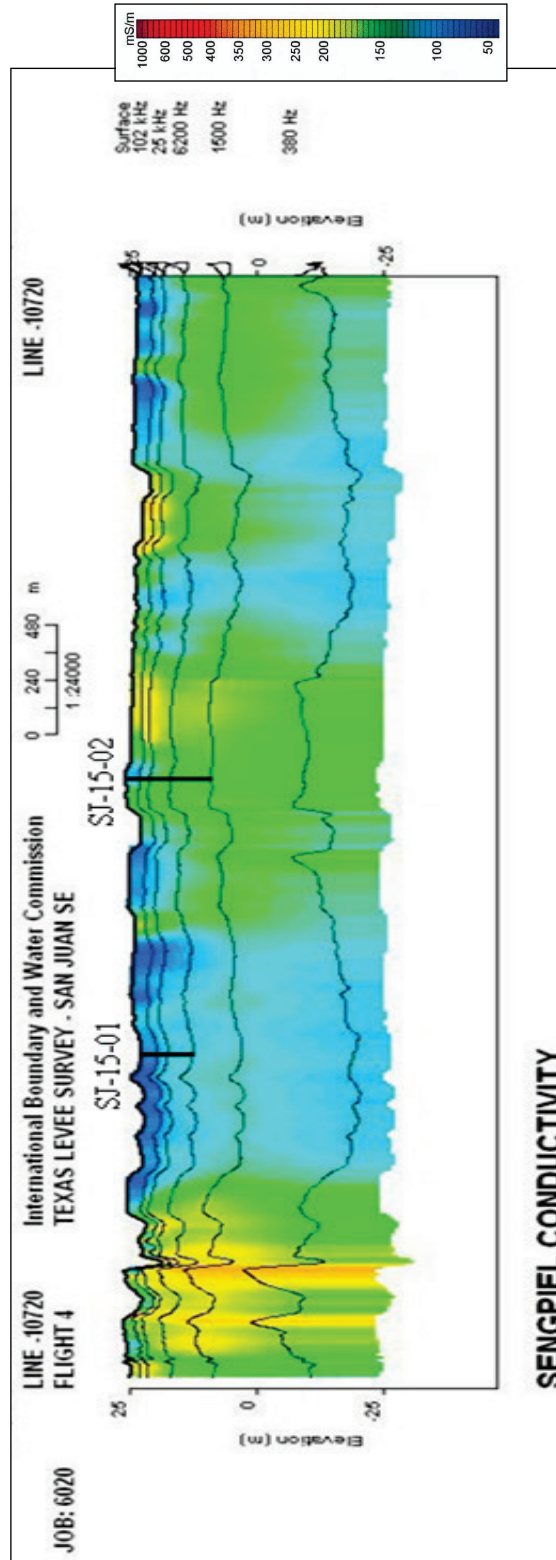


Figure 2-8. Fugro's DIGHEM system for levee mapping consists of five separate transmitters and receivers with frequencies at 102, 25, 9.2, 1.5, and 0.38 kHz (Hodges 2003).



The conductivity map shown is from one of the five frequencies (102 kHz). This type of survey can be useful to map blanket (top stratum) thickness for seepage related investigations and for mapping of the underlying floodplain geology (Figure 2-9). The survey profile in Figure 2-9 shows the response of five progressively decreasing (lower) frequencies along the levee toe as a continuous 2-D section of the individual survey points. The profile corresponds to the measured frequency as a function of the skin depth along the survey line. The individual measurements are plotted at the centroid depth for each frequency, where the centroid depth = $\frac{1}{2}$ skin depth as a function of the soil conductivity.

Figure 2-9. Conductivity profile or Sengpiel section of an airborne EM survey along a section of the levee toe from San Jaun SE USGS topographic quadrangle in Figure 2-7.



The concept of a dipole length in ground EMI systems limits the practical depth of investigation to slightly less than the calculated skin depth because of the geometry of these systems and the governing mathematical algorithms used by these systems to derive apparent conductivity. A general rule of thumb for single frequency, handheld EMI systems (e.g., Geonics EM 31 and 61) is that the depth of investigation into the ground is approximately one-half of the dipole length (Milsom 2003). Studies by Huang (2005) indicate that the empirical depth of investigation is approximately proportional to the square root of the skin depth for broad band (i.e., multiple frequencies) EM sensors, such as Geophex's GEM-2. Airborne sensors are not affected by this limitation because they operate under a *superposed dipole* condition, which occurs when the altitude of the sensor is more than three times the dipole length. The superposed dipole basically eliminates the dipole from the algorithm to derive apparent conductivity using airborne methods. However, the system response of the secondary field in EMI surveys decreases from the parts per thousand (ppt) range of the primary in ground-based sensor, to the parts per million (ppm) range in airborne sensors. Signal decay with altitude (a) is an inverse cubic relationship ($1/a^3$), and there is a practical limit to what can be detected at higher altitudes because of the decay relationship to altitude.

A further consideration of ground-based EMI methods is their response in highly conductive soils. The design of all commercial EMI ground-based instruments is that they operate in what is known as the low induction number (LIN) range. A system operates in the LIN range (B), when the intercoil (dipole) spacing (s) divided by the skin depth (δ) is less than 1 ($B = s/\delta \leq 1$). As long as this condition is valid then ground-based EMI systems are able to accurately measure the apparent or terrain conductivity. This relationship is possible because the conductivity values are linearly proportional to the ratio of the quadrature (i.e., part of signal at 90 deg out of phase with the measured value) of the secondary (H_s) to the primary (H_p) magnetic fields because of the simplification of the underlying mathematical expressions used to calculate the value for apparent conductivity.

Highly conductive ground will cause the instrument response to saturate and produces LIN(B) values that are greater than one. This condition ordinarily occurs where highly conductive surface soils are present and where wet soil conditions occur. Airborne systems are not normally affected by the LIN conditions because of the superposed dipole condition and the algorithms used to derive the apparent conductivity from the received signal. Consequently, airborne systems are sensitive to a broader range of

signal response, but their resolution decreases (volume of earth sampled increases) as a function of the sensor altitude.

However, the focus of these types of surveys is not necessarily a precise measurement of apparent conductivity (versus actual conductivity) along the survey tract but rather to determine the changes in response that occur spatially across the landscape. Additionally, it has been demonstrated from Rio Grande levee surveys by Dunbar et al. (2006) that the results of both ground-based and airborne surveys are relatively similar, but the vertical resolution and depth of investigation varies because of the larger volumes being sampled by airborne methods and/or by the larger dipole spacings using ground-based methods. Comparison studies of different geophysical methods indicate the overall trends are independent of the survey method employed and reflect characteristics of the soils and underlying stratigraphy. The primary response and resulting resolution are dependent on the volume of the earth being sampled and measured by these different methods.

The display of geophysical data is typically viewed as raster maps of the survey results (Figure 2-7 and profiles or graphs of conductivity for the individual frequencies as function of depth (Figure 2-9), as resistivity depth plots (Figure 2-10), or seismic profiles of velocity (p or s wave) as a function of depth (Figure 2-11). The multichannel analysis of surface wave (MASW) technique shown in Figure 2-11 measures the elastic stiffness of the levee embankment. The survey was performed on a test section of Rio Grande levee near San Juan, TX, that was flooded in a controlled test to monitor changes in the embankment properties during flooding (Dunbar et al. 2006; Miller and Ivanov 2005). In the plan view, geophysical data are often derived from individual sample points that have been gridded into a uniform raster cell size using interpolated smoothing functions. The resulting raster cell size is based on the sensor measurement spacing, which is a function of the speed of the instrument over the ground, the sampling frequency (number of sample measurements per second), spacing between contiguous survey lines, and a z-depth component (i.e., calculated apparent conductivity and skin depth relationship based on the transmitter frequency and measured conductivity).

For stationary type sensors (resistivity), the horizontal (x and y component) resolution involves a gridding function using decision rules about the line spacing or distance between sensors (electrodes) and/or a smoothing

function techniques (i.e., inverse distance weighted, spline, or kriging functions) for a uniform raster display of the survey data as shown by Figure 2-10. This figure presents the results of a time lapse resistivity survey. This technique measures the variation in current flow through the levee and foundation soils along the survey line. The profiles shown in Figure 2-10 represent a resistivity model of the levee and foundation after inversion of the resistivity data for each time period that was measured. This example is a time-lapse comparison from a controlled flood experiment along a portion of a cracked clay levee after a complete flood cycle that was 193 hr in duration. Lower profile shows the total change in resistivity that occurred between the beginning (top profile) and end (middle profile) of the simulated flood event (Dunbar et al. 2006).

For moving sensors, the velocity and frequency of the instrument sampling (number of samples per second) determine the actual sampling spacing distance and thus, the resolution becomes a function of the point density and the particular type of smoothing function used to create the uniform raster grid and depth profile (Figure 2-9). Data from moving sensors are typically gridded using precision Global Positioning System (GPS) coordinates and smoothing functions in different software programs (e.g., Golden Software (Surfer), Environmental Systems Research Institute's (ESRI) Spatial Analyst Extension, or Geosoft's Oasis Montaj) to create a georeferenced raster maps of the survey data. Thus, the resulting resolution involves both horizontal and vertical components of the survey. In summary, resolution issues involving geophysical data are generally more complex than remote sensing applications due to the subsurface nature of these surveys and the different factors that determine the depth of investigation.

Figure 2-10. Example of the results from an 80-m-long resistivity survey of a Rio Grande levee near San Juan, TX (Dunbar et al. 2006).

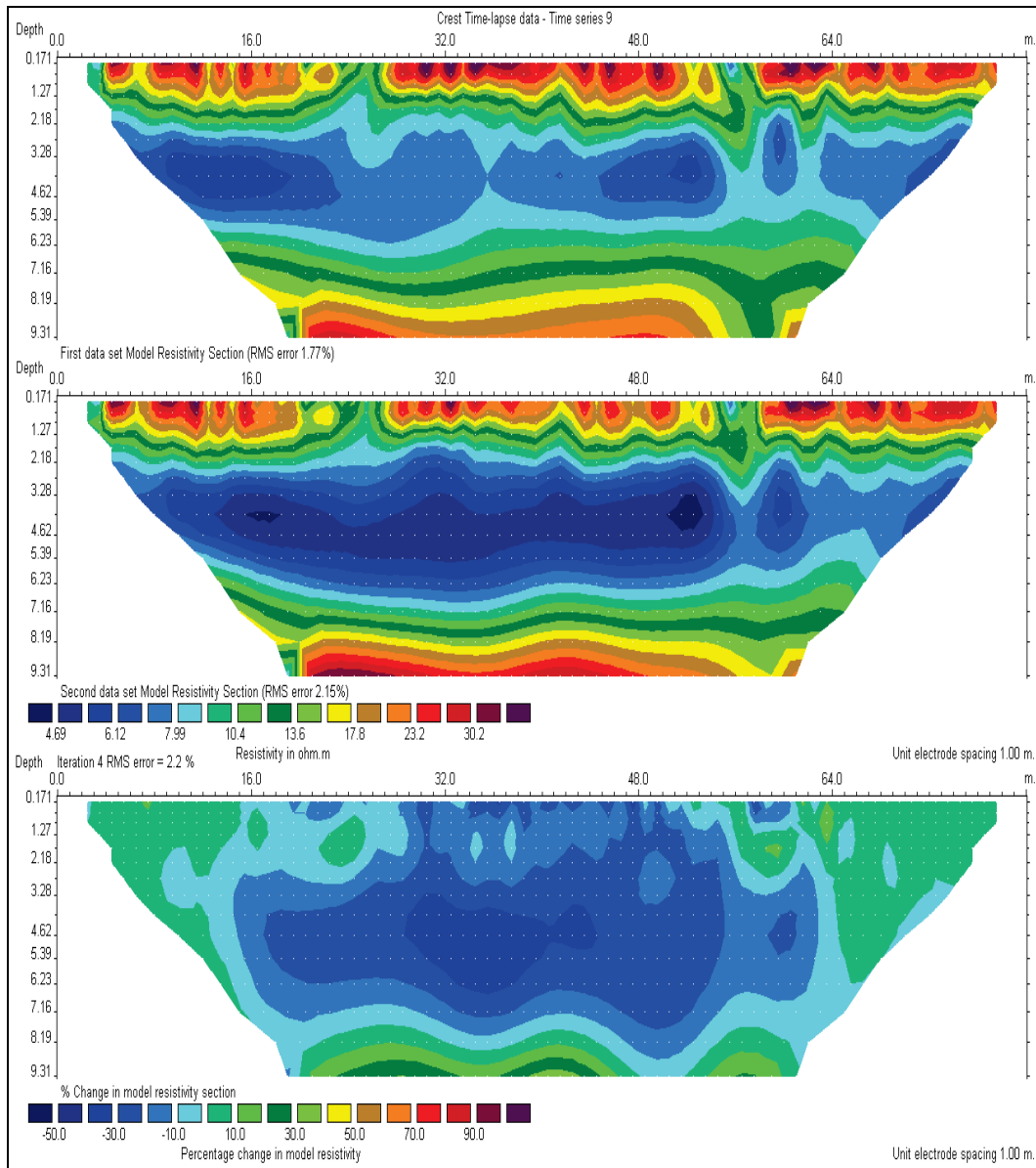
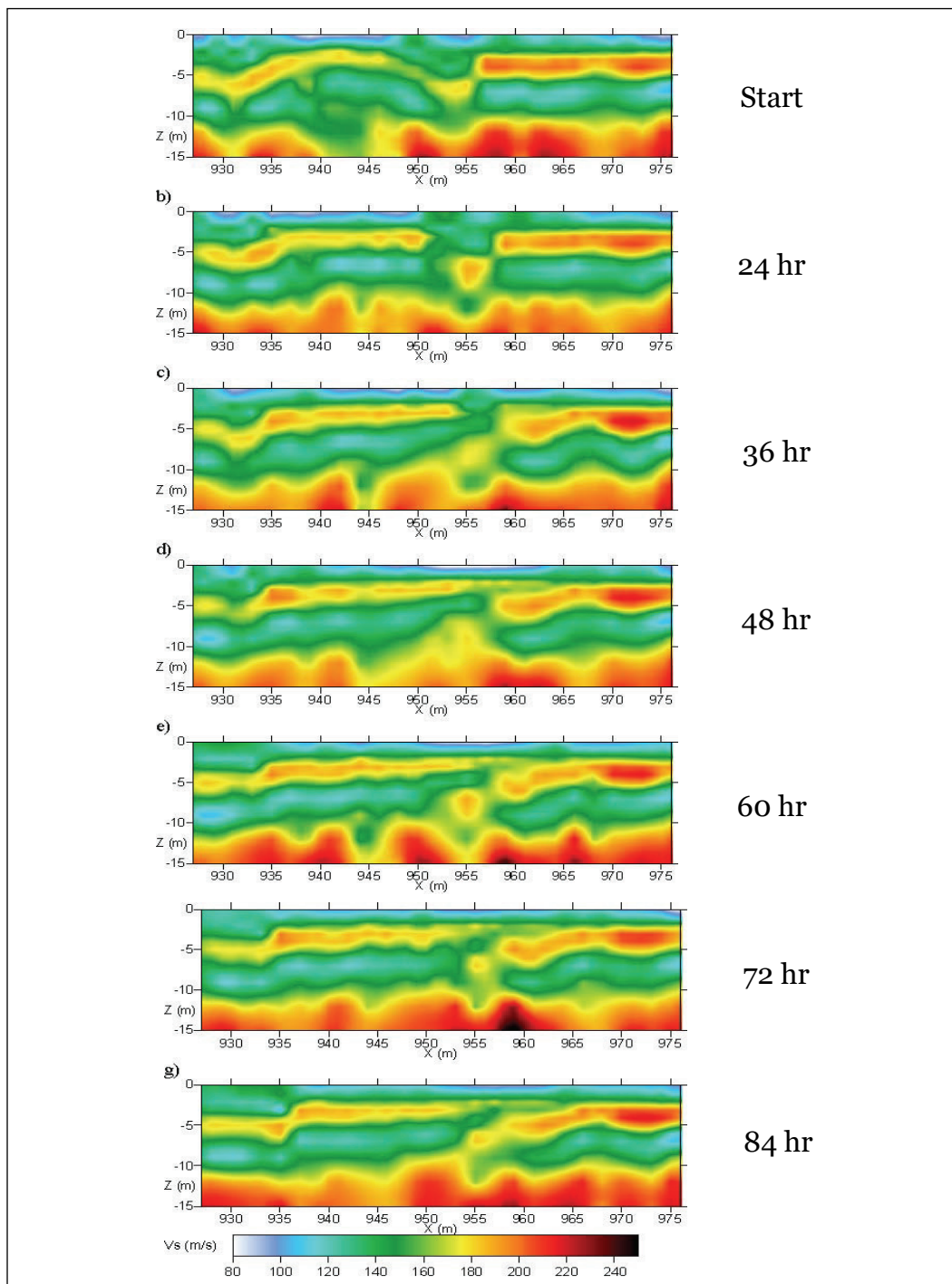


Figure 2-11. Example of a 45-m-long seismic survey of shear wave velocity of a south Texas levee using the multichannel analysis of surface wave (MASW) method.



2.6 Sources of remote sensing data

A wide variety of remotely-sensed data and derived products is available for download and purchase to support a broad spectrum of water infrastructure and flood-related studies. Both the USGS and the U.S. Department of

Agriculture (USDA) have data portals where historic remotely sensed data and derived GIS data products are available for download (Table 2-3). Another valuable source for GIS data is the individual states, where each state has a data portal for serving GIS and historic imagery (Table 2-4).

Table 2-3. Common sources for GIS data, aerial photography, and imagery.

Data Source	Web Address/Comments	Data Types
US Geological Survey	http://nationalmap.gov/	Index to Maps, Aerial Photography DRGs, DOQQs, DEMs, Transportation, Land Cover, Hydrography, Geographic Names, Transportation
US Department of Agriculture	http://datagateway.nrcs.usda.gov/	Soils, Historic Aerial Photography, Index to Maps, DRGs, DOQQs, DEMs, Transportation, Land Cover, Hydrography, Geographic Names etc.
Google Earth and Google Earth Pro	http://www.google.com/earth/ free image viewer with historic imagery and permits overlay of other GIS and lat/long data	Historic Imagery
GIS Data Depot	http://data.geocomm.com/ (data for purchase)	Index to Maps, DRGs, DOQQs, DEMs, FEMA Flood Data, Satellite Imagery, Transportation, Land Cover, Hydrography, Geographic Names, etc.
Landiscor Aerial Information	http://www.landiscor.com/ (data for purchase)	Full suite of imagery and GIS data products
ESRI ArcView 10 GIS Software	http://www.esri.com Current software version has built-in Web links to develop base maps of floodplain areas of the U.S.	Bing Imagery, Topographic Maps, Street Maps,

Table 2-4. Sources of GIS and imagery data by state (after <https://lib.stanford.edu/GIS/data>).

State	Data Portal Name	Link to GIS Data
Alabama	The Alabama Data Portal	http://portal.gsa.state.al.us/
Alaska	USGS: Alaska Geospatial Data Clearinghouse	http://agdc.usgs.gov/
Arizona	SCO: Arizona State Cartographer's Office	http://sco.az.gov/downloads.htm
Arkansas	University of Arkansas: Center for Advanced Spatial Technologies	http://www.cast.uark.edu/home/research/data-distribution-and-discovery.html
California	California Natural Resources Agency: California Environmental Information Clearinghouse	http://ceic.resources.ca.gov/index.html
Colorado	Colorado Department of Public Health and Environment: Geographic Information Systems (GIS)	http://www.cdphe.state.co.us/gis/
Connecticut	University of Connecticut: Map and Geographic Information Center	http://magic.lib.uconn.edu/
Delaware	Delaware Geospatial Data Exchange	https://dataexchange.gis.delaware.gov/
District of Columbia	The Premier Online Resource for GIS and Geospatial Data	http://data.geocomm.com/catalog/US/61072/
Florida	FGDL Metadata Explorer: Search & Download Data	http://www.fgdl.org/metadataexplorer/explorer.jsp
Georgia	Georgia GIS Clearinghouse	https://data.georgiaspatial.org/login.asp
Hawaii	State GIS Program- Office of Planning- State of Hawaii: Hawaii State Geographic Information System	http://hawaii.gov/dbedt/gis/
Idaho	INSIDE Idaho: Idaho's Geospatial Data Clearinghouse	http://inside.uidaho.edu/
Illinois	Illinois Natural Resources Geospatial Data Clearinghouse	http://www.isgs.uiuc.edu/nsdihome/ISGSindex.html
Indiana	IndianaMap	http://igs.indiana.edu
Iowa	Iowa State University: Geographic Information Systems	http://www.gis.iastate.edu/
Kansas	State of Kansas GIS Data Access & Support Center	http://www.kansasgis.org/
Kentucky	Kentucky Geography Network: Explore the Commonwealth!	http://kygeonet.ky.gov/
Louisiana	Atlas: The Louisiana Statewide GIS	http://atlas.lsu.edu/
Maine	Maine Office of GIS	http://www.maine.gov/megis/
Maryland	From the Maryland Department of Natural Resources: Geospatial Data	http://dnr.dnr.state.md.us/gis/data/
Massachusetts	Office of Geographic Information (MassGIS)	http://www.mass.gov/anf/research-and-tech/it-serv-and-support/application-serv/office-of-geographic-information-massgis/
Michigan	Michigan DTMB: MI Geographic Data Library	http://www.mcgi.state.mi.us/mgdl/
Minnesota	GeoGateway: Minnesota Geographic Data Clearinghouse	http://geogateway.state.mn.us/documents/index.html
Mississippi	MARIS: Mississippi Automated Resource Information System	http://www.maris.state.ms.us/
Missouri	Missouri Spatial Data Information Service	http://www.msdis.missouri.edu/
Montana	Montana Geographic Information Clearinghouse	http://nris.mt.gov/gis/default.asp
Nebraska	Hosted by the Nebraska Department of Natural Resources: Nebraska Geospatial Data Center	http://www.dnr.state.ne.us/databank/geospatial.html
Nevada	W.M. KECK: Earth Sciences & Mining Research Information Center	http://keck.library.unr.edu

State	Data Portal Name	Link to GIS Data
New Hampshire	NH GRANIT: New Hampshire's Statewide GIS Clearinghouse	http://www.granit.unh.edu/
New Jersey	New Jersey Geographic Information Network	https://nigin.state.nj.us/NJ_NJGINExplorer/index.jsp
New Mexico	RGIS New Mexico Resource Geographic Information System Program: RGIS Clearinghouse	http://rgis.unm.edu/
New York	Division of Homeland Security and Emergency Services: NYSGIS Clearinghouse	http://gis.ny.gov/?nysgis=
North Carolina	North Carolina Center for Geographic Information and Analysis	http://www.cgia.state.nc.us/
North Dakota	North Dakota Geographic Information Systems	http://www.nd.gov/gis/
Ohio	Ohio Geographically Referenced Information Program	http://ogrip.oit.ohio.gov/ProjectsInitiatives/StatewideImagery.aspx
Oklahoma	University of Oklahoma: Center for Spatial Analysis	http://www.csa.ou.edu/
Oregon	Oregon Geospatial Enterprise Office (GEO)	http://cms.oregon.egov.com/DAS/EISPD/GEO/Pages/sdlibrary.aspx
Pennsylvania	Pennsylvania Spatial Data Access: The Pennsylvania Geospatial Data Clearinghouse	http://www.pasda.psu.edu/
Rhode Island	Rhode Island Geographic Information System	http://www.edc.uri.edu/rigis/
South Carolina	University of South Carolina: Campus GIS Program	http://artsandsciences.sc.edu/gis/
South Dakota	Department of Environment & Natural Resources: South Dakota Geological Survey	http://www.sdgs.usd.edu/
Tennessee	Tennessee Spatial Data Server: An Official Source of Tennessee GIS Data	http://www.tngis.org/
Texas	Texas General Land Office	http://www.glo.texas.gov/
Utah	UTAH AGRC: Automated Geographic Reference Center	http://agrc.its.state.ut.us/
Vermont	Vermont Center for Geographic Information	http://www.vcgi.org/dataware/
Virginia	University of Virginia Library: Scholar's Lab: Geospatial Data Portal	http://gis.lib.virginia.edu/
Washington	Washington State Geospatial Clearinghouse	http://metadata.gis.washington.edu/geoportal/catalog/main/home.page
West Virginia	West Virginia GIS Technical Center: WV State GIS Data Clearinghouse	http://wvgis.wvu.edu/data/data.php
Wisconsin	DNR Geographic Information Systems (GIS)	http://dnr.wi.gov/maps/gis/
Wyoming	University of Wyoming: Wyoming Geographic Information Science Center (WyGISC)	http://www.uwyo.edu/wygisc/

A third source of imagery and GIS data is commercial companies that collect and sell imagery and derived data products. Common examples of companies and agencies that market imagery and data products are identified in Table 2-3 and Figure 2-9. This list is not comprehensive by any means, but it serves as examples of government and commercial sources for data involving study of water infrastructure needs. The various satellites identified in Table 2-1 also provide data for purchase.

Satellite data and imagery involving USACE projects should be coordinated with the Army Geospatial Center (AGC), Topographic Engineer Center, Alexandria, VA, at <http://www.agc.army.mil>. Their goal is to “*collect once, share with all*” in the Department of Defense (DOD) and USACE community, especially those projects involving water infrastructure and flood monitoring. Disaster response requests are also coordinated through the AGC for efficient data collections and disseminations.

2.7 Sources of geophysical data

Three different types of geophysical data exist for purposes of evaluating flood-control structures. The first category involves site specific information that is targeted at particular problems associated with portions of a flood-control structure experiencing engineering problems (e.g., leakage, seepage, movements of the slope, presence of sinkholes and voids). The second category involves floodplain mapping of large aerial extent for assessment purposes, prioritizing levee segments for risk of poor performance, and planning of conventional boring programs to evaluate geotechnical stability. The third and final category involves basin-wide datasets for use in regional planning and evaluation of hazard potential to flood systems. The focus of the following discussion is to provide context to the types of geophysical data used for input into these different categories.

Geophysical data for flood-control structures are usually site specific in nature and usually acquired on an as-needed basis by the owners of dams and levee systems experiencing engineering problems. Much of the geophysical research for water related flood-control infrastructure has been sponsored by federal government agencies that have an aging inventory of flood-control structures with performance issues. Federal agencies conducting geophysical studies include the USACE, USDA, U.S. Bureau of Reclamation (USBR), and the US Section of the International Boundary and Water Commission (USIBWC or IBWC). All of these federal agencies have been involved in research efforts using geophysical methods for purposes of

evaluating poor performance in their earthen embankments, dikes, and dams. Additionally, the USGS has been involved in extensive geophysical research into assessing geological hazards and for purposes of flood-control structures in support of the federal agencies with an inventory of levees and dams and for groundwater studies.

As with most federal agencies that have active research programs, these different organizations typically produce technical reports and publications that describe and document their respective research programs and/or surveys of investigations that have been performed to evaluate specific problems with flood-control structures. Additionally, both the government and private sector support this research by providing geophysical services for purposes of engineering, construction, and environmental projects (examples include: Asch et al. 2007; Ball et al. 2006; Dunbar and Llopis 2005; Burton and Cannia 2011; Hunter et al. 2007; Koester et al. 1984; Llopis and Simms 2007; Llopis and Sjostrom 1988; Llopis et al. 2007; McKenna et al. 2006; Nazarian and Diehl 2000; USBR 1992).

Federal agencies and commercial companies that conduct geophysical study of levees and dams are typically active in professional organizations, such as the Environmental and Engineering Geophysical Society (EEGS at <http://www.eegs.org/>). Members generally discuss their research activities in presentations and poster sessions at the annual meeting of the Symposium on the Application of Geophysics to Environmental and Engineering Problems (SAGEEP). In addition to EEGS, the U.S. Society of Dams (USDS), Association of State Dam Safety Officials (ASDSO), the Association of Engineering Geologists (AEG), and the Society of Exploration Geophysicists (SEG), typically host sessions at their annual meetings that have a water infrastructure focus, which involves geophysical study of levees and dams.

Geophysical surveys within the first category of interest are generally applied to answer specific questions about performance issues and characteristics of the earthen embankment or its foundation. This type of geophysical survey is local in nature and usually address a specific problem about the structure. Problems that are typical of flood-control structures involve performance related issues associated with flood loading, embankment and foundation instability, and subsequent deterioration from aging and/or cyclic loading. Problems often associated with flood-control structures include liquefaction potential of the foundation from earthquake

loading, determination of the depth to bedrock, identifying changes in soil and stratigraphy along the levee alignment, identifying faults and fracture zones beneath the structure, quantifying groundwater conditions, identifying the permeability of the aquifer or embankment, understanding the underseepage and piping potential, detecting voids or low density zones in the foundation or embankment, locating conduits, determining the safety of the slope and any movements of the slope, and/or other characteristics relevant to engineering (Reynolds 2012). Problems typically associated with the embankment involve seepage, slope stability, presence of voids, locating conduits, embankment distress and cracking, and problems that are associated with leaking conduits due to deterioration of metal, concrete, and/or the water-stops between the different segments of the conduit. Geophysical surveys are often used to target these types of engineering problems. This category of geophysical study is described in greater detail in Chapter 6.

A second category of geophysical data involves linear surveys of large tracts of levee systems by ground-based and airborne methods for assessments of floodplain scale reaches (Figures 2-7 and 2-9 are examples). These types of surveys usually involve EM and magnetometer (MAG) methods and are conducted for screening and assessment purposes, to identify anomalous zones in levee foundations, and for classification of levee reaches into geologically similar zones for a comprehensive geotechnical evaluation. Geophysical data are useful for detection of geological and man-made anomalies in the foundation and for targeting borings in anomalous areas for geotechnical programs for evaluation of levee systems. Conventional boring programs involving evenly-spaced borings can often miss localized anomalous features that require special foundation treatment, and non-contact geophysical methods are preferred to acquire continuous data. Airborne surveys of large floodplain extent include studies by Abraham et al. (2011), Dunbar et al. (2003; 2004), and URS (2008) for purposes of aquifer characterization and levee assessment purposes. Additionally, ground-based geophysical surveys are routinely employed to assess conditions along long smaller-scale levee reaches where airborne methods are not economical because of the reduced aerial extents involved (Burton and Cania 2011; Dunbar and Llopis 2005).

Another use for airborne EM surveys that has application to flood-control structures involves ice and permafrost mapping in northern latitudes. This method is especially attractive in polar areas for permafrost applications in

engineering, construction, climate monitoring, sea ice thickness, and groundwater-surface water interactions (USGS 2011). Ice has a highly resistive signature in resistivity and EM surveys and can be easily mapped by the electrical geophysical methods. Airborne EM mapping provides a rapid method to conduct large footprint surveys to measure the depth to the permafrost layer, seasonal changes in permafrost extent, and ice conditions.

The third and final category of geophysical data involves national datasets for use in planning studies and for large, regional scale assessment purposes. An important example of this type of dataset involves GPR suitability maps of the United States by the USDA (Doolittle et al. 2003; 2007) at <http://soils.usda.gov/>. These suitability maps (Figures 2-12 – 2-14) provide important information on whether the GPR method is a suitable geophysical tool based on estimated response to known mapped soil types. A major limitation of the GPR method is the lack of depth penetration in conductive soils because of the skin depth relationships of EM radiation described earlier. A GPR suitability map of the United States is shown in Figure 2-12 and identifies locations where this method is restricted because of the nature of the underlying geology. Clay-dominated alluvial settings and bedrock outcrops of clay-shales and shale rock can significantly impact GPR signal response and cause poor resolution for this technique.

Figure 2-12. Ground penetrating radar suitability map of the United States
(http://www.nrcs.usda.gov/Internet/FSE_DOCUMENTS/nrcs142p2_053093.pdf).

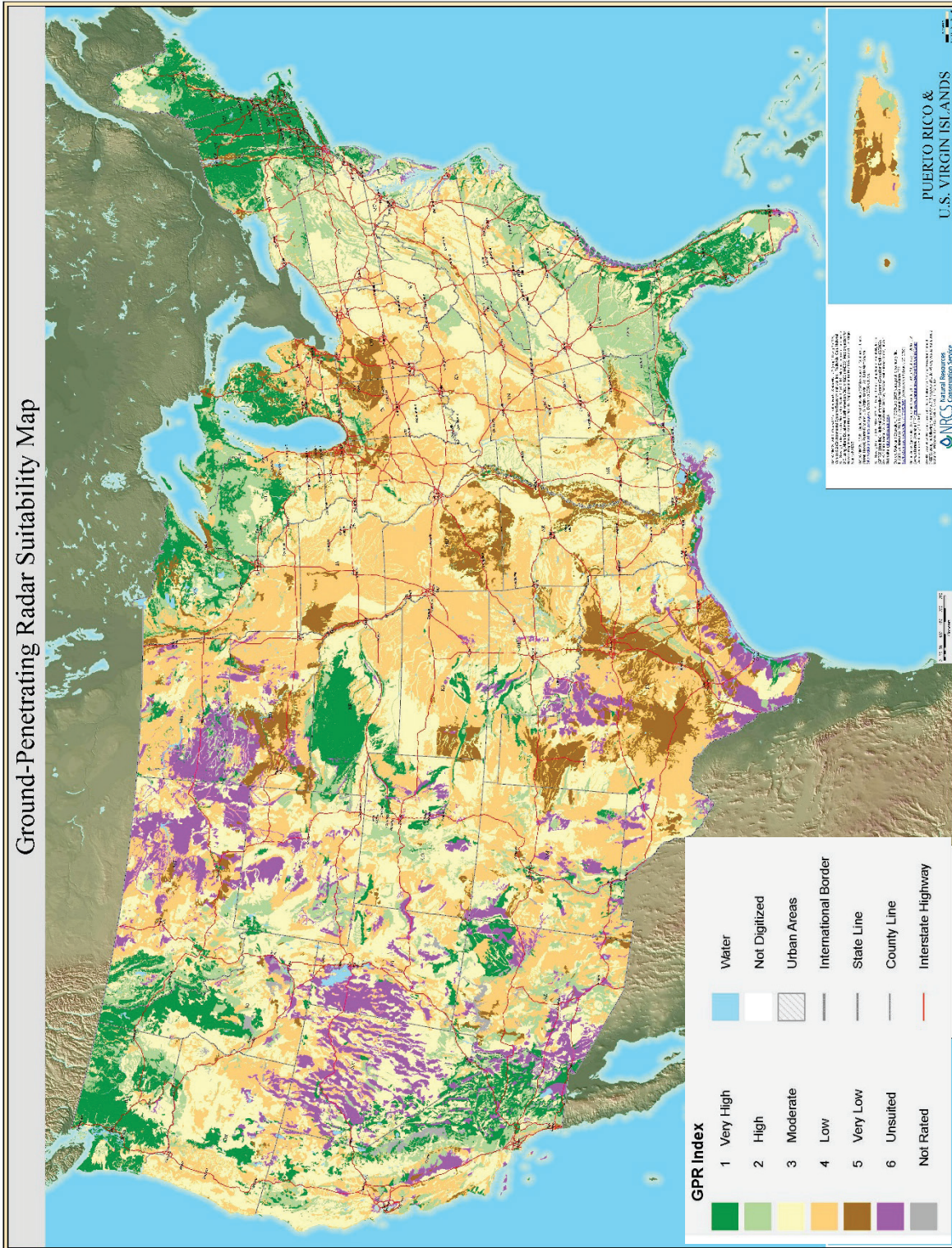


Figure 2-13. Ground penetrating radar suitability map of Mississippi
(http://www.nrcs.usda.gov/Internet/FSE_DOCUMENTS/nrcs142p2_051841.pdf).

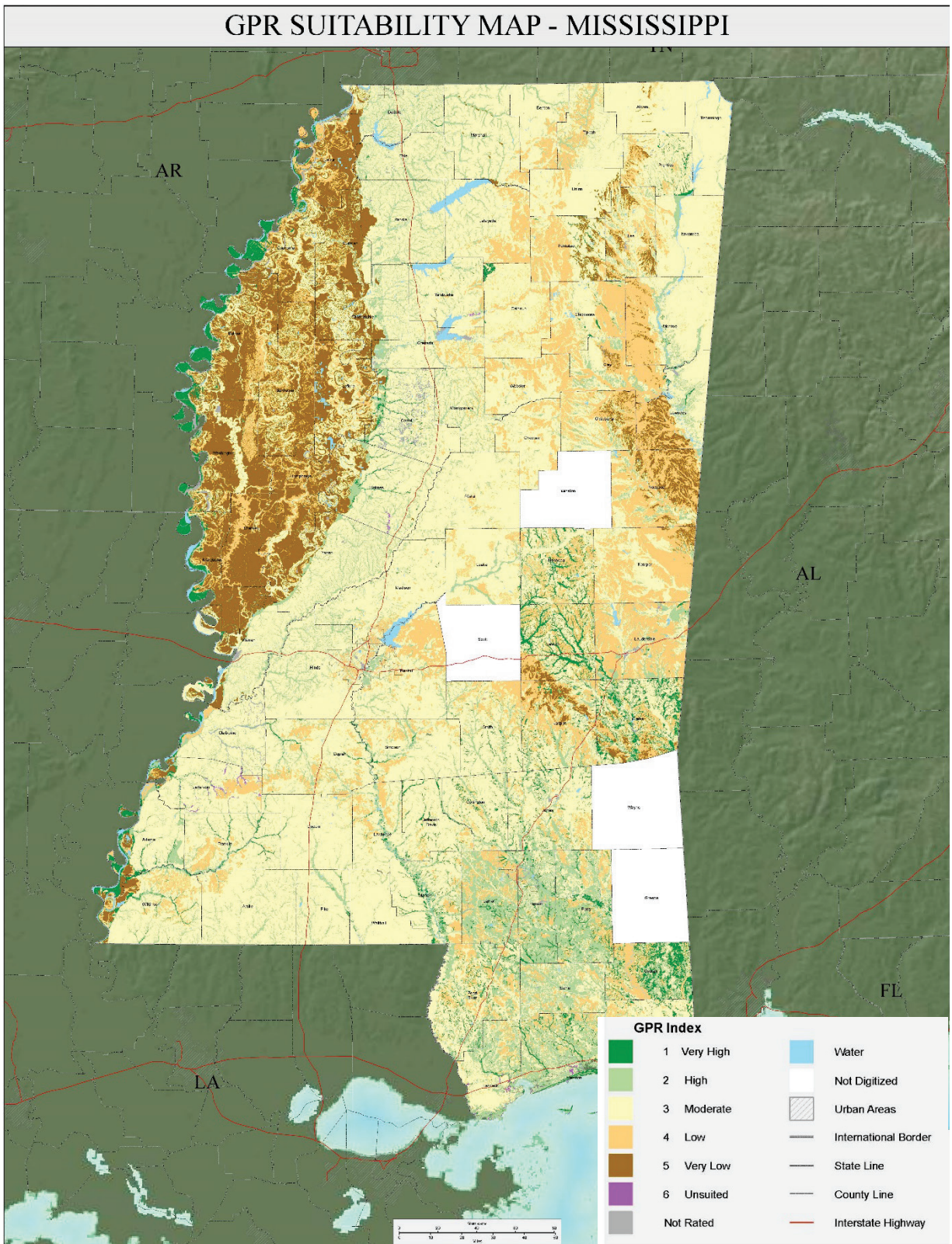
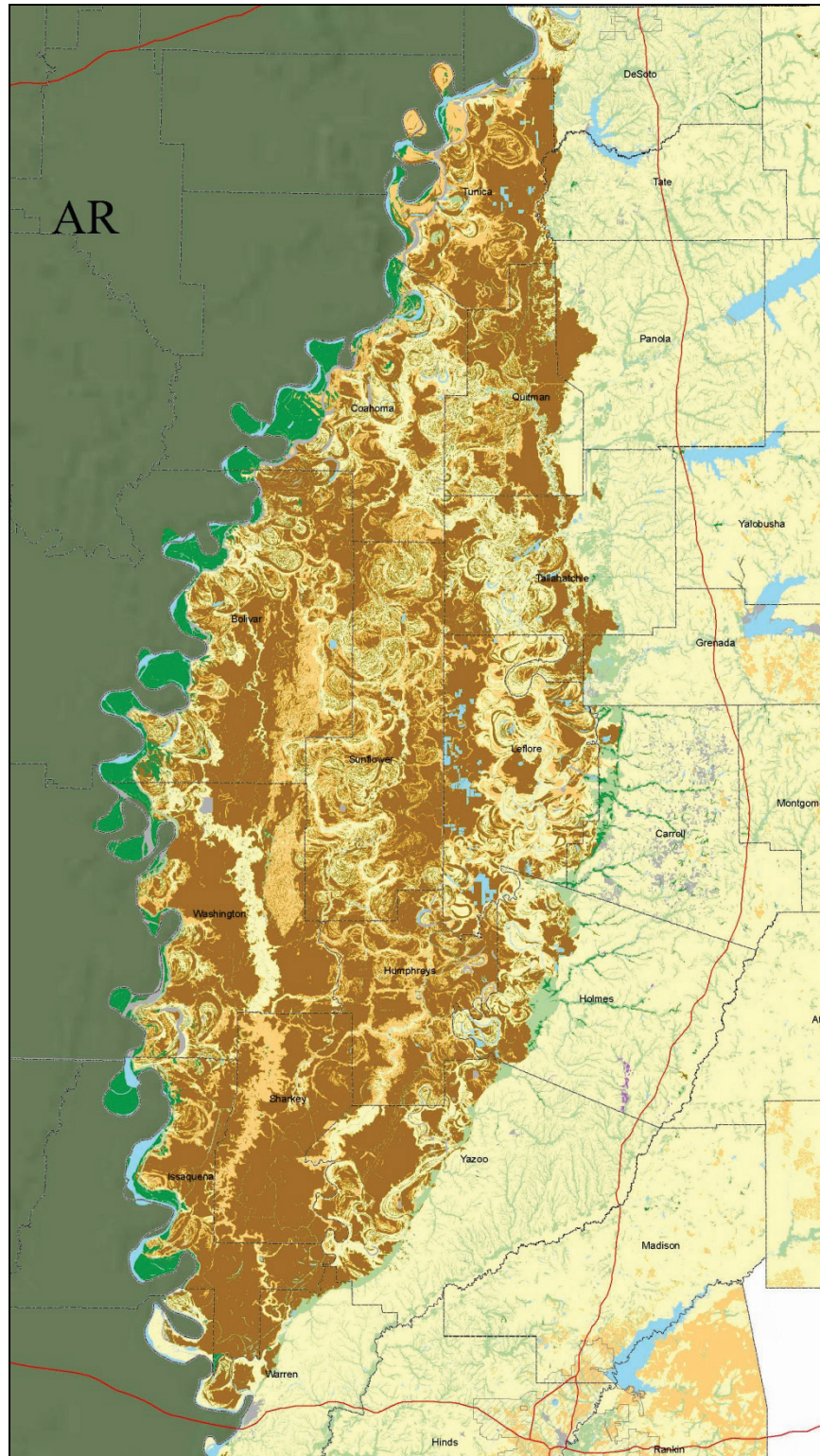


Figure 2-14. GPR suitability map of the Yazoo drainage basin and the relationship of floodplain geology and soils. Brown areas correspond to flood basin/backswamp and tan areas are point bar deposits

(http://www.nrcs.usda.gov/Internet/FSE_DOCUMENTS/nrcs142p2_051841.pdf).



Another important dataset that is useful for planning purposes of flood protection system investigations is derived from the National Geophysical Data Center (NGDC) at <http://www.ngdc.noaa.gov/ngdcinfo/onlineaccess.html>. This Website contains valuable data on natural hazards impacting coastal flood-protection systems. These low-lying areas are vulnerable to catastrophic events, especially tsunamis. Coastal areas in the western United States are especially prone to tsunamis from earthquake areas bordering the Pacific Ocean (Dunbar and Weaver 2008). Merging bathymetry and topographic data from western U.S. coastal areas is especially important for modeling impacts to populated regions by tsunamis (Eakins and Taylor 2010). The development of integrated bathymetric-topographic digital elevation models (DEMs) is important for evaluating the risk to low-lying coastal areas because of this flood hazard, which can result in overtopping of flood-control systems. Overtopping failure mechanisms from tsunami-driven events have historically not been considered in evaluations of west coast levee systems that protect low-lying regions. The NGDC has an online DEM discovery portal that assists with modeling of coastal areas and determining tsunami vulnerability (<http://www.ngdc.noaa.gov/mgg/dem/demportal.html>). A comprehensive review of erosion hazards affecting coastal zones within the United States is presented in a report by The Heinz Center (2000). This report provides valuable information about the different types of problems and their magnitude across the United States.

3 Levee Failure Modes

3.1 Introduction

Remote sensing and monitoring of flood-control systems involves a broad range of technologies within the EM spectrum, including space, air, and ground sensors, different sampling methods, and associated data products (i.e., imagery, photography, elevation, and geophysical data) as well as information gained from stationary point sensors (i.e., temperature, water level and pressure, inclination, and soil properties of interest to the engineer). Flood-control systems are normally designed to reduce the risk of flooding from natural hazards involving catastrophic storm-driven events, but generally have not considered the long-term impacts from sea level rise, or less frequent tectonic-driven events in geologically vulnerable areas. Remote sensing and monitoring have traditionally been incorporated into evaluating and predicting these environmental forces and in consequence mapping because of these events (Tralli et al. 2005; Joyce et al. 2009; and Bally 2012). A central theme of this chapter is incorporating remote sensing and monitoring technologies into the traditional inspection process, as well as during flood conditions when the system components and design are tested.

Failure of man-made levees, soil embankments, or dikes is the result of erosion and generally occurs by one of four general failure mechanisms: overtopping, surface erosion, internal erosion (either from through seepage or in the foundation by underseepage), and by slope failures or slides in the levee embankment and the foundation (HQUSACE 2000). Levee failures can occur by any of these mechanisms in response to natural fluvial processes and can occur in both low and high water settings. The four levee failure mechanisms are reviewed in this chapter to provide general background information about their characteristics to help focus attention on the discussion of the appropriate remote sensing and monitoring methods for early detection and warning.

However, before proceeding with a discussion of levee failure mechanisms or failure mode analysis in risk assessments, it is first appropriate to describe the concept of a standard levee section and its evolution through time. Standard levee sections across much of the United States are local in nature, representative of flood conditions that occur in the respective

drainage basin where they are located, and have evolved because of performance issues during historic flood events.

3.2 Standard levee section

3.2.1 Definition and history

The construction of standard levee sections is a common characteristic of many flood-control systems built across the nation that were assumed or built by the federal government during the Depression years (1929-1939) when the science of soil mechanics was in its infancy. A standard levee section is oftentimes a levee that was built without the benefit of detailed engineering analysis of borrow (soil), not in accordance with modern construction practice, and without an understanding of foundation conditions. The standard section was usually built using local knowledge of soil conditions and successful practical experience gained from flood fighting during major events. Standard levee sections are usually limited to levees of moderate height, generally less than 25 ft (7.62 m), and typically involve slopes of 1 vertical (1V) to 2.5 or 3 horizontal (2.5 to 3H) for levees built of fine-grained soils, and flatter slopes of up to 1V:5H for coarse-grained construction (HQUSACE 2000).

Early experience with levee construction was gained from the protection of agricultural lands against flooding and practical experience from local flood control efforts. Legacy standard levee sections form a significant component of the flood protection systems that were built in the United States and currently serve to protect urban and nonurban areas alike. A focus of concern with legacy flood protection infrastructure involves historic changes in land-use and the transition from agricultural to urban areas with corresponding increases in population living behind these older legacy levees. The evolution of legacy levees has often involved multiple upgrades in height and changes in slope through time. Typically associated with these improvements has been poor control of the soils used in their construction, lack of compaction specifications, and failure to follow modern construction techniques. Legacy levees often contain the original agricultural levee core within the current prism. Legacy levees are fairly common place for most of major river systems that flow within the United States, where levee systems were built to reduce the risk of flooding in low-lying floodplains.

3.2.2 Mississippi River example and 1947 Levee Code

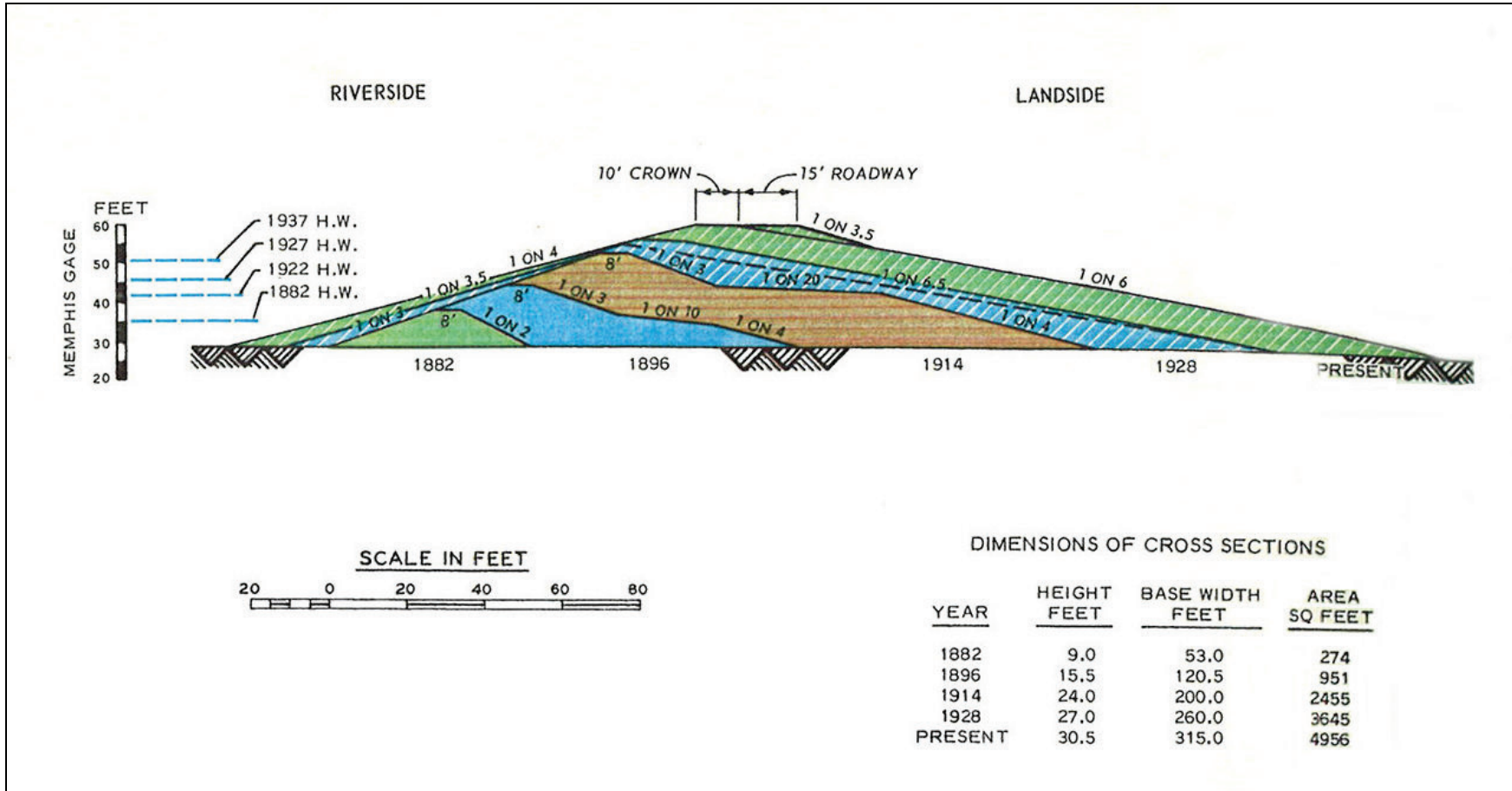
The Mississippi River system is used as an example to highlight the evolution of a standard levee section through time (Figure 3-1). This evolution in levee design was described by Moore (1972) as a performance-based progression of the design that occurred over a 50-year time span and involved multiple changes after each major flood before a stable profile was established. A final levee design was adopted by the Mississippi River Commission (MRC) after approval of the 1947 Levee Code (USACE 1947). The 1947 Levee Code established the final prism of the levee, which is designed to control levee through seepage under a design flood by using a 1 on 4 riverside and 1 on 6 landside slope (USACE 1947).

The 1947 levee design considered flood loading, duration, foundation geology, construction and compaction methods, and flood-fight activities required to contain a large flood event for this major river system. The final design evolved in response to system performance and the deficiencies observed in the system after each flood event. These deficiencies were then subsequently repaired after each flood. Corrective measures employed included river channel stabilization (i.e., cut-offs, revetment, control dikes, stone armoring, spur dikes and levees), levee raises, and seepage control measures (i.e., berms, blankets, relief wells, and cutoff trenches). Moore (1972), Ferguson (1939), and Elliott (1932) describe the evolution and design of the Lower Mississippi River flood-control system in detail.

The Mississippi River flood of 2011 again tested this design during a record flood event, and areas where performance issues occurred were revealed during this event (USACE 2011b; Nimrod 2011). The Mississippi River standard levee section in Figure 3-1 established standards for the rest of the nation. Empirical lessons learned from flood-control measures on the Mississippi River are summarized in the current USACE levee engineering manual and from the analytical methods developed to evaluate levee seepage (Mansur et al. 1956a, 1956b; HQUSACE 2000).

An important recommendation of the 1947 Levee Code was the need to better define the floodplain geology for evaluation of levee stability against the different failure mechanisms observed. A major concern for levee stability in the alluvial valley was internal erosion by seepage forces, because of the pervious nature of the underlying geology, and the long duration, steady-state floods that are characteristic of this system.

Figure 3-1. Mississippi River standard levee section that evolved through time in response to levee performance during following of a major flood event (Moore 1972).



Geological characterization of the Mississippi River Alluvial Valley was undertaken by a team of geologists working for the MRC and the U.S. Army Corps of Engineers Waterways Experiment Station (WES) over a 50-year period (Fisk 1941, 1944; Saucier 1994). Geological reports and maps by these geologists are presented at the Lower and Middle Mississippi Valley Engineering Geology Mapping Program Website at: www.lmvmapping.erd.c.usace.army.mil. This level of effort in mapping the geology of the levee foundation in the Mississippi River Valley is unique in the United States for its scale and benefit to levee engineering.

3.3 Overtopping

3.3.1 Failure mechanism

Overtopping of levees occurs when the flood height exceeds the crown elevation of the levee. Usually, levee height is based on an economic decision that involves a flood of a specified recurrence interval or probability and is determined from a detailed hydraulic analysis of drainage basin area, floodplain characteristics, vegetation growth, and historic precipitation data. Because of the National Flood Insurance Program (NFIP), many levees across the United States are built or rated to a 1 percent flood (1 in 100-year event), indicating the levee height will contain and pass this event at a maximum stage of 3 to 5 ft (0.9 to 1.5 m) below the crest of the levee. The levee height above the maximum design flood stage is termed freeboard and is generally 3 to 5 ft (0.9 to 1.5 m), depending on whether the levees are built for agricultural or urban levels of protection.

Higher levels of protection are normally required for urban areas as compared to agricultural areas. Generally, 1 percent flood heights have been calculated by deterministic methods, using historic precipitation and performance data. Using the Mississippi River as an example, the project design flood for the Mississippi River and Tributary Project (MR&T) is based on a complicated and complex routing of storms that far exceeds the 100-year or possibly even the 500-year event. The concept of levee freeboard has been revised and replaced by terms of annual risk of flooding. Current USACE policy expresses flood protection as being the probability of occurrence, with the design height expressed in terms of the annual flood event (i.e., 100, 250, 500, or larger). USACE guidance on levee evaluation for the NFIP is contained in HQUSACE (2010).

3.3.2 Remote monitoring and inspection

Remote sensing methods incorporating LiDAR data, satellite imagery, aerial photography, and digital imagery are used to identify any changes in land-use and vegetation in the flood corridor that may impact the capacity of the system to accommodate a project flow. Current imagery should be incorporated into the annual levee inspection program and the five-year levee assessments of the entire flood-protection system. Important to this effort is documenting locations where massive sedimentation or scouring in the flood corridor occurs and any other stability problems observed along the main channel of the river within the flood-protection system.

The intersection of a tributary junction with the main channel is especially vulnerable to changes in sedimentation, where aggradation of the channel bed occurs by building of local deltas and the resulting loss of levee freeboard at these locations. This condition is especially problematic in semi-arid environments, following large flood events that move coarse sediment down the alluvial valley and along high gradient mountain rivers that can transport gravel and cobble bed loads during annual winter snow melts. LiDAR surveys are an important tool for monitoring changes in floodplain elevation. Establishment of regularly spaced cross-valley/floodplain elevation profiles along the down-valley longitudinal profile is recommended for monitoring topographic variations through time. Routine monitoring and survey of these profiles should be incorporated into any assessment process. Again, annual or biannual LiDAR surveys are useful tools for effective monitoring of elevation changes that can impact levee freeboard.

Changes in vegetation within the flood corridor can have secondary impacts in terms of flood discharge, velocity, and duration and possibly affect and reduce the freeboard. Periodic evaluation of the hydraulic models of the flood conveyance system should be performed to ensure the project flood can be safely contained within the levees because of significant vegetation growth. Color-IR imagery is especially helpful for monitoring changes in vegetation growth as spectral signatures reflect different vegetation types.

Remote inspection is best accomplished by imagery that is 1 m or less in pixel resolution and ideally would involve a spatial resolution of better than 20 cm for inspection purposes of small scale features (Figure 2-5). Change assessment strategy incorporating LiDAR data is an especially attractive method for monitoring freeboard and any reductions in the

levee height through time from the design profile (Casas et al. 2012). Additionally, first return LiDAR data contain the vegetation signal and can be used to identify the presence of trees, especially on the levee right-of-way. USACE policy (HQUSACE 2000, 2006a) involving federal funding of Public Law (PL)-84-99 levees requires woody vegetation to be removed to at least 15 ft from the toe of the levee or berm because of potential impact on access during flood fight, and the added possible risk of poor performance due to encroachment of woody vegetation into the levee section. Another important factor is grazing livestock, which can create trails that destroy vegetation and contribute to surface erosion or even reduce the levee height, especially at crossing points for access to water. Imagery can assist with identification of these areas.

Use of GIS analytical-based tools incorporating GIS software and DEMs are especially important to manage large elevation datasets. Low-lying coastal areas that are subject to tsunamis and deltaic areas prone to subsidence are especially vulnerable to small changes in levee elevation from catastrophic storm events (Eakins and Taylor 2010). Interferometric SAR has been successfully used for monitoring changes in elevation in urban deltaic regions in the New Orleans area (Dixon et al. 2006). In alluvial settings, recent SAR research has focused on using pattern recognition technology and soil moisture to assess levee condition and distress (Aanstoos et al. 2011, 2012a, 2012b). These studies have focused on evaluating shallow slides caused by changes in soil moisture. Coastal subsidence due to sedimentary loading of the Gulf of Mexico basin poses long-term stability issues for overtopping. Coastal zones experiencing sea level rise, combined with active subsidence in drowned alluvial valley settings are prime candidates for long-term monitoring to ensure resiliency of engineered flood-control structures through time and to protect public safety by ensuring that storm surge design elevations are maintained.

3.4 Surface erosion

3.4.1 Failure mechanism

Surface erosion is primarily a problem for levees constructed of non-cohesive soils (mixed sand and gravel, sand, silty sands, and silts) and usually occurs during high-water events when the flood flow extends beyond the channel onto the floodplain and encounters the nearby levee prism. Surface erosion involves removal of material from the levee toe or slope because of fluvial scouring caused by the concentration of local

currents and by the orientation of these currents against the levee surface due to the levee alignment, the confluence with tributaries, or any other defects in the levee surface that contribute to irregular currents. Topographic irregularities in the levee surface may be caused by woody vegetation, man-made obstructions, penetrations, or burrowing animals, all of which can negatively impact the levee and its surface. Excessive degradation of the embankment slope by scour can lead to failure of the levee because it reduces the ability of a levee to resist the water pressure acting against its surface. Grass-covered slopes, scour protection (armored rock slopes or soil cement mixtures), and effective levee maintenance can help to prevent surface erosion. Levee maintenance involves programs to prevent growth of trees on the slopes or at the toe, control burrowing animals from digging into the levee, and prevent grazing livestock on levees where animal traffic degrades the height and vegetation cover of the levee. An effective maintenance and inspection program can significantly help to protect levee slopes from developing topographic irregularities, which may concentrate surface flows and further contribute to erosion issues.

3.4.2 Erosion toolbox

USACE (2007) has developed an erosion toolbox to support the nationwide levee risk assessment method. The purpose of the toolbox is to estimate the conditional probability of failure of existing levees from surface erosion. The toolbox incorporates geotechnical, hydraulic, and probabilistic principles to assess the ability of the levee to withstand a design flood event against failure due to surface erosion. The variables needed in the assessment process include type of levee (homogenous, with internal cut-off walls, engineered/zone-engineered, floodwalls type A or B) (Note: Type A floodwalls penetrate into levee materials only, while Type B are constructed directly on foundation materials, composition of levee soils, levee geometry, presence of armoring, vegetation, and structures (e.g., flood walls, cut-offs, penetrations). Remote sensing using both satellite and airborne imagery is a valuable tool in providing input into the decision parameters to support the models.

3.4.3 Remote monitoring and inspection

Remote sensing methods incorporating LiDAR data, satellite imagery, aerial photography, and digital imagery can assist with monitoring surface erosion in levees. Current imagery should be incorporated into the annual

levee inspection program and in five-year levee assessments of the flood-protection system. Important to this effort is documenting locations where sedimentation or scouring in the floodplain occurs and any other stability problems observed along river reaches within the flood protection system. Remote sensing examination for slumping, slides, deep gullies, and other types of erosion of the levee slope should be performed periodically as part of the annual inspection process. Inspection is a continuous process and requires both remote methods as well as field inspection to verify results of the classification from digital imagery.

Remote inspection of surface erosion is best accomplished by imagery that is 1 m or less pixel resolution and ideally would involve a pixel resolution of better than 20 cm for inspection purposes of small features (Figure 2-5). Again, change assessment and detection strategies incorporating LiDAR data are especially attractive methods for monitoring subtle changes in levee side slopes and identifying deep gullies and/or decreases in the levee height.

3.5 Internal erosion

3.5.1 Introduction

Internal erosion involves the movement of seepage water through the levee section and erosion of soil particles within the levee because of the flow of water under the steep hydraulic gradients that develop between the landside and riverside of the levee. Internal erosion can be especially problematic in levees constructed of pervious soils, levees that are poorly compacted (especially around conduits or utility lines that penetrate the levee section), or cracked levees. Additionally, internal erosion can occur in the levee foundation, where pervious sand deposits occur beneath the levee embankment because of the presence of coarse-grained alluvial deposits and certain types of depositional environments that contain thick sands. Among the most problematic of these depositional environments in terms of underseepage are point bar deposits (Figures 3-2 through 3-5). Sand boils at the landside levee toe can form in these deposits due to high hydrostatic pressures developed in the lower substratum (aquifer) sands, which can cause uncontrolled movement of soil particles from the levee foundation to the land surface (Figure 3-5).

The presence of sand boil activity behind the levee in point bar alluvial settings can be fairly extensive and distant from the main channel because of the widespread occurrence of substratum sands, which is the pathway for

underseepage flow (Figure 3-4). Meandering river systems by their very nature create the ideal conditions during high river stages for levee underseepage and artesian conditions necessary for sand boils in point bar deposits to occur (Figure 3-2). The ridge and swale topography that is created by the channel migration process and abrupt changes in depositional environment that are encountered in these deposits can concentrate seepage during high river stages (Figure 3-3). Point bar deposits are especially problematic for underseepage.

Sand boils can occur at the levee toe, especially in areas where the soil permeability changes suddenly due to the intersection of a point bar swale (fine-grained area between point bar ridges), abandoned channel or course, and/or oblique angle to the levee orientation (Figure 3-3). Nearby borrow pits that expose the substratum sands are entry points for flood waters and shorten the seepage path. Important factors include the orientation of the levee to the local geology, the thickness of the topstratum, and cracks or other defects in the topstratum, which can influence underseepage potential and location of boils behind levees (Mansur et al. 1956a; 1956b). Studies by the USACE in 1956 identified the geologic, hydraulic, and man-made conditions that are problematic for underseepage in levees, which are highlighted by Figure 3-3 (Mansur et al. 1956a, 1956b). This study found that abrupt changes in substratum permeability caused by abandoned channels and ridge and swale topography are especially favorable for sand boil formation.

3.5.2 Characteristics of point bars

Two fundamentally different types of depositional processes occur in fluvial systems (Figure 3-2). Lateral accretion occurs in the active channel and forms coarse-grained, sand-dominated deposits (i.e., point bar landforms). Ridge and swale topography is characteristic of point bars and forms as sand bars accumulate on the low energy or convex side of the channel. Vertical accretion occurs principally adjacent to and outside of the main channel, as suspended sediment is transported to the distal parts of the floodplain during flooding. The fine-grained or upper deposit of the point bar as well as point bar swales (low area between sand bars) forms by the vertical accretion process. Landforms that develop because of vertical accretion are natural levees, crevasse splays (deposition resulting from a break in the natural levee), and flood basins (also known as backswamps or inland swamps) as shown by Figure 3-2.

Figure 3-2. Block diagram showing major floodplain environments (Miall 1985; 1996). Environments shown are point bar, flood basin (backswamp), abandoned channels (oxbows), and natural levees (identified as levee in diagram). The upper fine-grained unit is the top stratum, while the lower or coarse-grained unit is the substratum (see boundaries identified by dashed red lines in the block diagram).

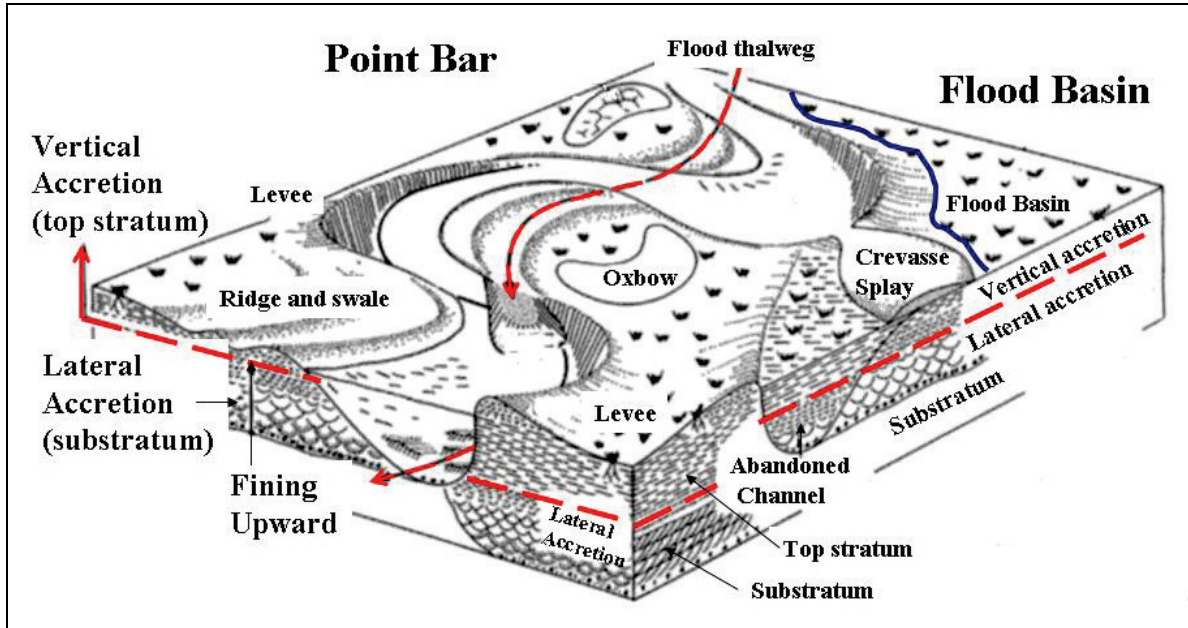
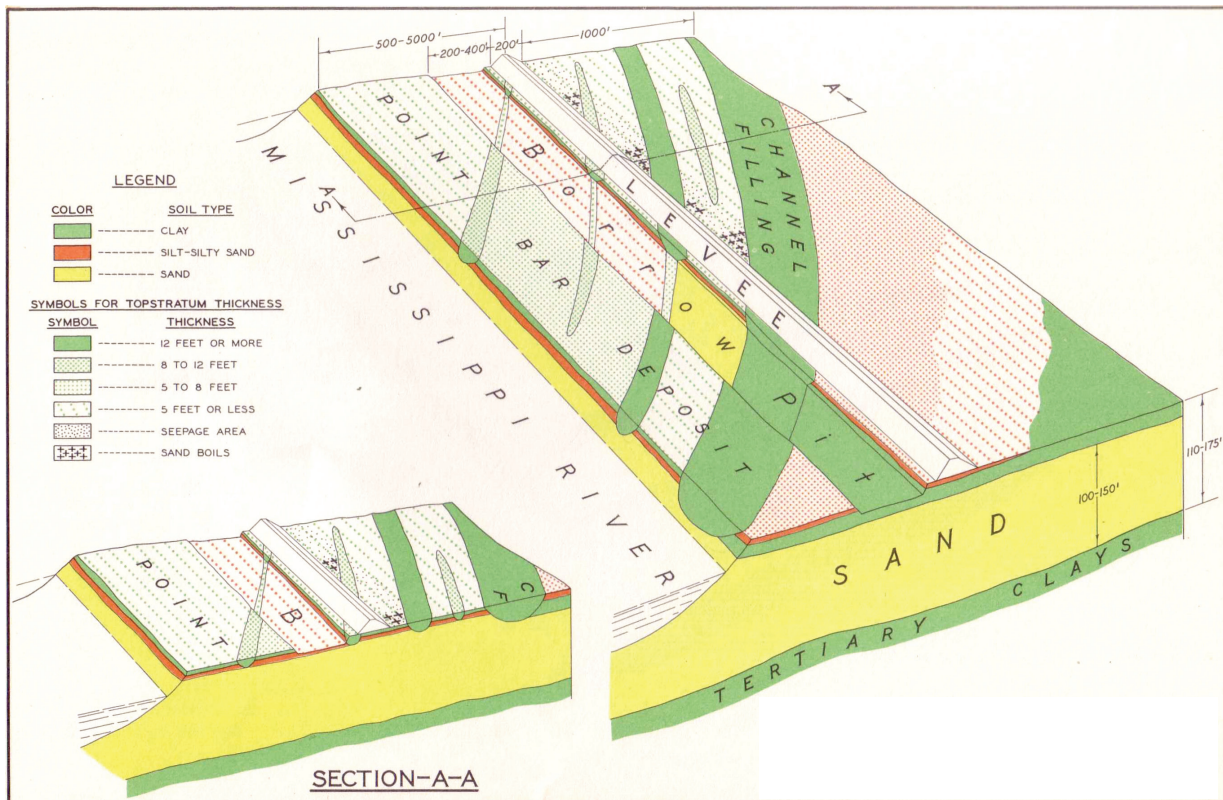


Figure 3-3. Seepage through point bar deposits of thin clay and silt with intervening clay-filled swales (Mansur et al. 1956a, 1956b).



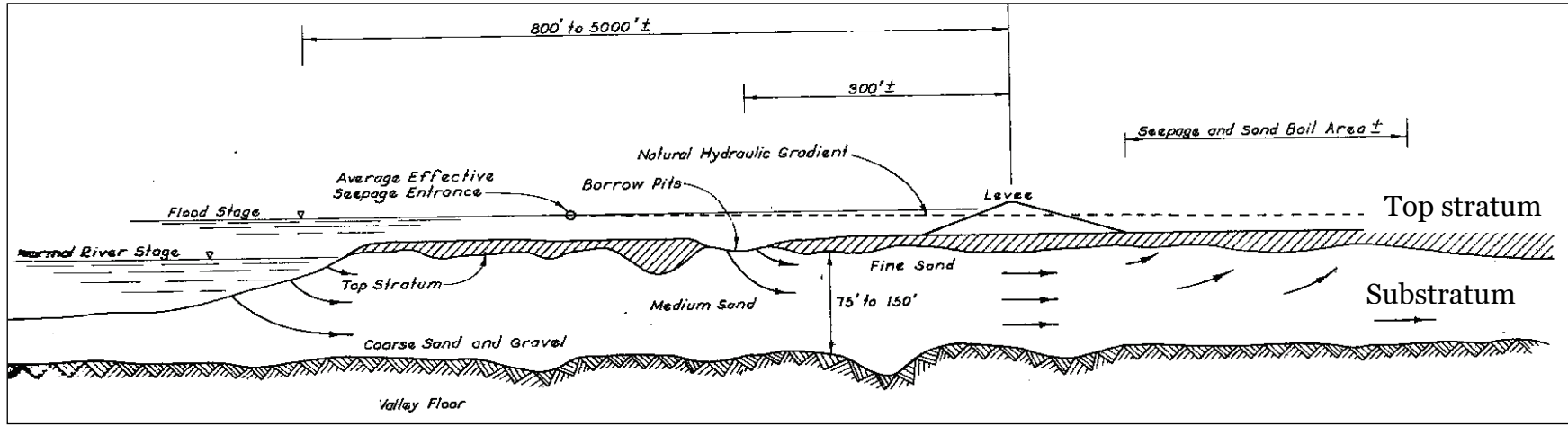
3.5.3 Failure mechanisms

Internal erosion by seepage forces can produce failures by three general mechanisms: heave at the levee toe, piping, and seepage erosion (Ozkan 2003). Heave occurs at the levee toe when the hydrostatic pressures in the pervious foundation are greater than the weight of the fine-grained overburden to resist the higher pore pressures acting against the bottom of the blanket, which is usually composed of a fine-grained (primarily clay, identified by a diagonal soil pattern in Figure 3-4) point bar top stratum (Figure 3-4). This condition can be problematic in alluvial valleys containing a meandering river system that forms point bar deposits composed of a thin top stratum or blanket and a thick sandy substratum (Figure 3-2). The substratum deposits shown in Figure 3-4 are 75 to 150 ft thick (fine to coarse sand and gravel). Heave is often associated with sand boils and hydraulic fracturing of the clay blanket by the artesian pressures below the blanket, which can lead to concentrated seepage and boil formation. The main channel, borrow pits at riverside levee toe, or other defects in the top blanket can be entry points for seepage (Figure 3-4).

Additionally, buried beach deposits in deltaic regions, containing thin clays and low density organic clays overlying the pervious beach sands, can create these conditions as well. The London Avenue Canal I-wall and levee failures in New Orleans during Hurricane Katrina in 2005 are examples of this type of vulnerable foundation geology, where a combination of heave, boil formation, movement of foundation sands beneath the levee, void formation, and eventual levee failure occurred. Subsurface sand deposits can quickly become fully saturated during a major flood event and lead to steady-state conditions, where groundwater flow moves under the levee because of the steep hydraulic gradients produced.

Piping typically occurs in embankments and foundations of cohesive soils, where removal of material from the levee or the foundation produces open channels or pipes because of the “roofing” property of the fine-grained blanket and by the concentrated flow of water through the pipe. This pipe eventually progresses to the source of water with time. The pipe then continues to enlarge and can result in catastrophic failure as the embankment collapses into the underlying void created by the pipe. Animal burrows and tree roots in the levee prism are especially problematic and may provide pathways for a pipe to form. Additionally, tree stumps and their root systems can provide a roof to support pipes and piping conditions.

Figure 3-4. Generalized cross section of the geology beneath a levee in a meandering river system (Mansur et al. 1956b).



Seepage erosion occurs by the steep hydraulic gradients that develop between the flooded and landside of the levee and can cause loss of soil from either the levee embankment or the foundation. Through seepage occurs in the body of the levee and is significantly increased by the presence of cracks in the levee, poor compaction, defects (e.g., tree roots, animal burrows, utilities), or by coarse-grained soils used to construct the levee. Movement of soil particles due to through seepage erodes and weakens the body of levee to withstand the force of the water that it is designed to hold. Underseepage occurs in the previous substratum or aquifer sands that can lead to heave of the blanket and cause sand boils to form, which results in levee collapse due to loss of foundation material.

A common problem with sand levees during prolonged flood stages involves the passage of the wetting or seepage front through the body of the levee. This occurrence leads to steady-state conditions, where seepage exits in the lower third of the landside slope and may remove soil particles from the levee surface. The adoption of the 1947 Levee Code on the Mississippi River recognized this condition in fine-grained, clay levees by requiring 1V to 5.5 to 6 H slopes on the landside to control steady-state seepage conditions in the lower third of the levee slope (Figure 3-1). Long duration floods on the Mississippi River can soften even clay levees by prolonged seepage, leading to wet and “spongy” conditions at the landside levee toe.

A common problem in sandy levees from seepage occurring at the landside toe of the levee slope is that it can entrain soil particles on steep slopes. Consequently, flatter slopes are employed to effectively control the potential movement of soil particles eroding from the levee in embankments constructed wholly of sand that experience steady-state conditions during long duration floods. Levees constructed of sand are usually built on flatter slopes, which are typically designed at 1V:5H slope or flatter to control the potential of seepage erosion at the land side levee toe (HQUSACE 2000).

3.5.4 Remote monitoring and inspection

Remote sensing methods incorporating both satellite and aerial digital imagery can assist with monitoring seepage conditions and sand boil formation behind levees during major flood events. However, this type of monitoring is especially difficult because of the need for a high frequency inspection cycle, and the high spatial resolution required to detect small-scale sand boils behind the levee during a major flood event. Monitoring

for sand boil activity is a complex problem, which is discussed here in some detail to better highlight the mechanism and failure process, and a significant challenge for current remote-sensing capabilities.

LiDAR is an important monitoring tool to measure slope requirements and whether the levee profile meets the design standards established for the respective flood-control system. This technology is especially important for monitoring the levee right-of-way in the dry state. However, it is unlikely that LiDAR will be an effective method for real-time emergency flood monitoring because of the presence of standing water from seepage, the repeat cycle needed for real-time detection, and the hidden nature of the failure mechanism that is at play.

Internal erosion, as the name implies, occurs below the ground surface where traditional remote sensing techniques cannot penetrate because of the small wavelengths ordinarily used (i.e., EM skin depth principles described in Chapter 2). SAR-based sensors are similarly limited because of the physics and the presence of the standing water from extensive seepage conditions behind the levee and oftentimes the presence of saturated ground conditions typical of rainfall-driven flood events.

Geophysical monitoring methods can detect changes in soil moisture related to seepage flow as it directly affects soil conductivity. Geophysical methods for seepage detection in embankment dams are summarized by Lum and Sheffer (2010) and described in detail in a series of reports by the Canadian Electrical Association Inc. (Johansson et al. 2005). These methods are not able to directly detect the loss of soil particles from the embankment or in the foundation other than by measuring localized changes in conductivity signatures and/or by changes in seismic velocity using cross-hole tomography methods. The latter requires the presence of evenly-spaced boreholes and a seismic infrastructure to support a continuous monitoring program. The economics of scale makes in situ seismic monitoring impractical for levees. This technique has been successfully adopted for high-hazard dams with a known history of internal erosion to detect density contrasts in the core should internal erosion occur (Gaffran and Jefferies 2005).

3.5.5 Engineering considerations and evaluation factors

The Mississippi River system is used again as an example of conditions that normally occur in a major flood. The presence of seepage behind the levee is

a common occurrence. Seepage behind the levee is described as being light, moderate, or heavy. Characteristics of seepage conditions are described by Cunny (1987) in Table 3-1. An empirical relationship between seepage and sand boil formation to exit gradient through the blanket was developed by USACE in 1956 from the study of levee performance at selected sites along the Mississippi River as shown by Figure 3-5 (Mansur et al. 1956a, 1956b). The concept of exit gradient (i_o) involves the ratio of the residual head at the levee toe to the blanket thickness ($i_o = h_o/z$, see Figure 3-6) and forms the basis for current levee design (HQUSACE 2000) and engineering countermeasures (Figure 3-7). Countermeasures include pervious blankets, landside berms, relief wells, collector ditches, and sand bagging of boil areas (Moore 1972). The piezometric surface is based on well data, or is estimated from equations by Mansur et al. (1956). These equations were derived from empirical study of underseepage sites within the Lower Mississippi Valley (LMV) (Figure 3-4).

These variables are, pervious substratum thickness (d); river height (H), residual head (h_o), critical exit gradient (i_{crit}) $\left(i_{crit} = \frac{\gamma_{sat} - \gamma_w}{\gamma_w} \right)$, exit gradient ($i_o = h_o/z$); landside top stratum or top blanket thickness (z); saturated unit weight of soil (γ_{sat}); and unit weight of water (γ_{wat}).

The critical gradient (i_{crit}) is based on the material properties of the top blanket soil. A critical gradient occurs when the pore pressures at the base of the top blanket are equal to the total overburden weight acting downward, leading to the potential for blanket heave and/or development of sand boils and movement of foundation material. A value of $i_{critical} = 0.85$ is based on a top stratum unit weight of 115.4 lb/cu ft, a representative value for fine-grained Mississippi River top stratum deposits.

Table 3-1. Severity of underseepage (Cunny 1987).

Condition	Description
Light	Area wet at and beyond levee toe
Moderate	Running water is observed at and beyond levee toe
Heavy	Presence of pin boils (small pipe openings without sand cones) with running water
Sand boils	Any pipe openings with sand cones
Large boils	Sand boils with pipe openings 12 in. or more in diameter

Figure 3-5. Empirical relationship between landside seepage and exit gradient through the top stratum from study of point bar deposits along the Mississippi River (Mansur et al. 1956a).

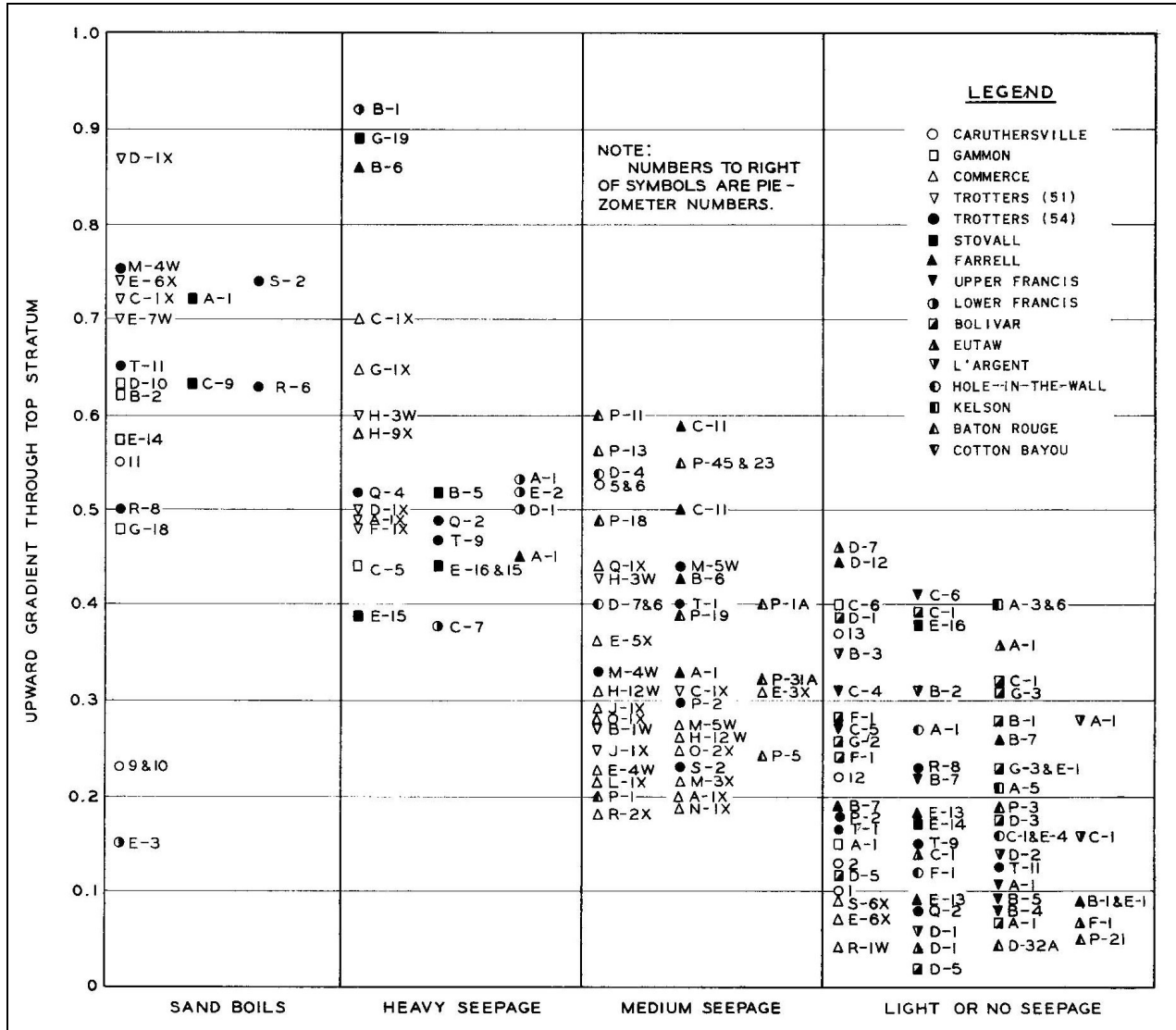


Figure 3-6. Mathematical basis for the analysis of seepage under levees is based on the height of the piezometric surface (h_0) at the toe of the levee and the exit gradient (Sills and Vroman 2005).

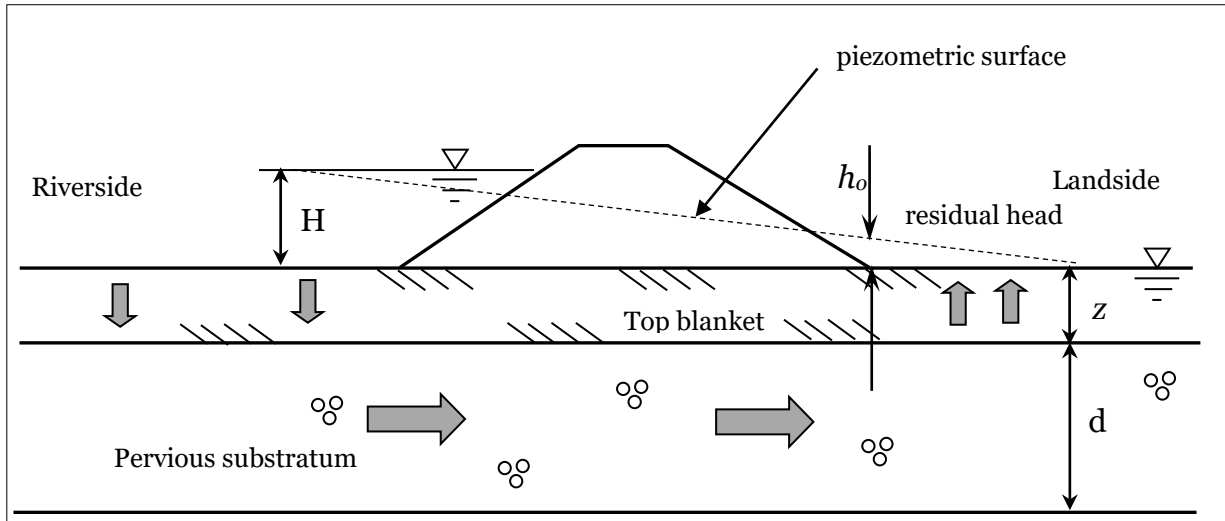
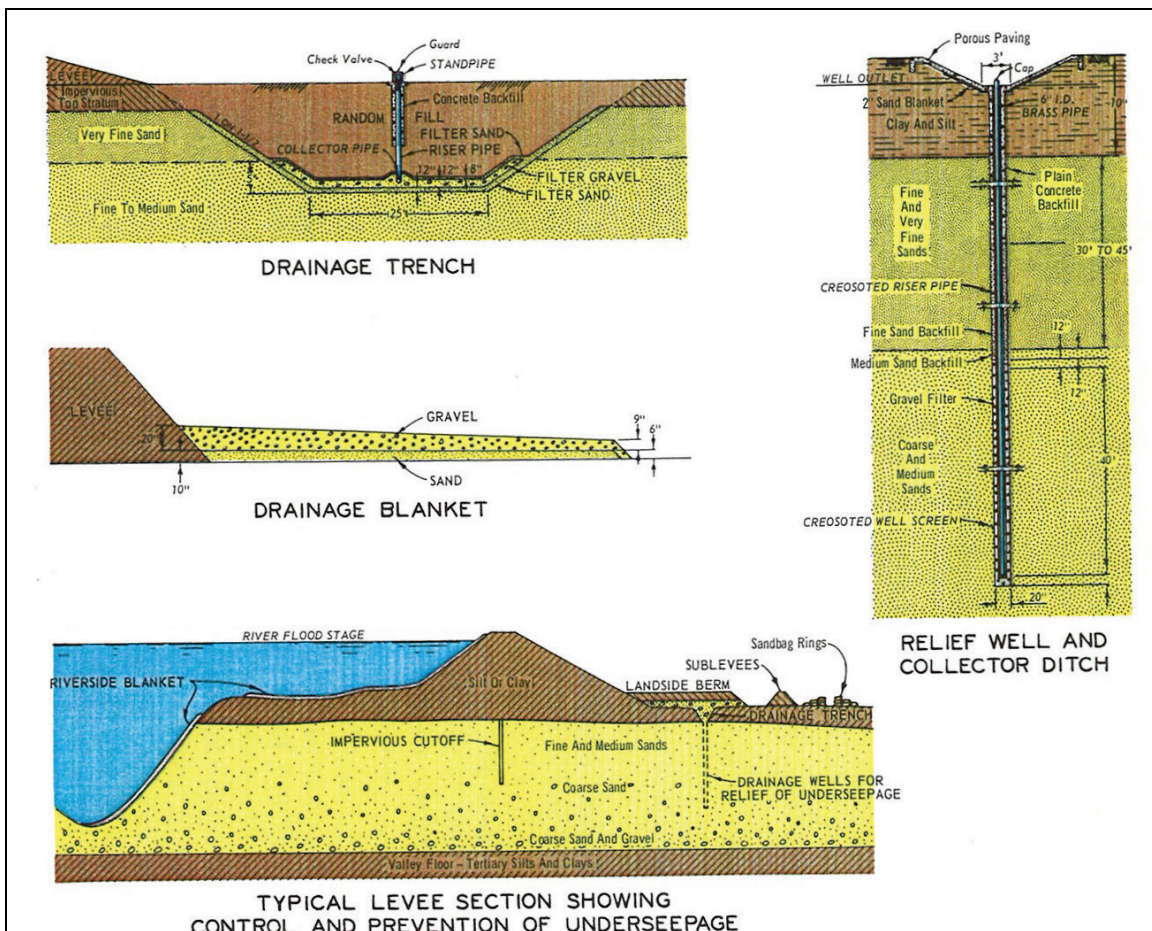


Figure 3-7. Control and prevention of underseepage in areas with exit gradients of 0.5 and greater at the levee toe (Moore 1972).



Current Corps policy (HQUSACE 2000) states that (a) if the exit gradient at the levee toe is less than 0.5, then no remedial measures are necessary; (b) if the exit gradient at the levee toe is between 0.5 and 0.8, then a minimum berm of 150-ft width should be designed; and (c) if the exit gradient is greater than 0.8, then a seepage berm should be designed with a maximum width of 300 to 400 ft and with an allowable upward gradient of 0.3 through the blanket and berm at the landside toe (Sills and Vroman 2005; HQUSACE 2000).

The complex relationship between severity of seepage, exit gradient, and blanket thickness along the levee right-of-way underscores the difficulty of relying on current generation satellite and airborne imagery in the visible and reflected IR portions of the EM spectrum to accurately assess the severity of seepage conditions through the levee and behind the levee. These methods rely solely on surface inspection techniques and are dependent on the infrequent repeat cycle for these systems to conduct change detection inspections. Visual inspection during flood fight has been the most effective method to date for detecting unsatisfactory performance from sand boil activity because of the 24/7 inspection cycle, direct observation field conditions as they occur, and ability to target problem reaches with known performance issues.

The design of the Mississippi River levee system was never intended to be a leak-proof system against seepage but rather one that could be managed by flood flight activities. The 1947 Levee Code that established the standard levee section for the Lower Mississippi River preceded the development of current USACE analytical tools for the evaluation of levee stability from seepage (Mansur et al. 1956a, 1956b; HQUSACE 2000). Thus, the 1947 Levee Code was based entirely on system performance and practical experience gained from levee maintenance and flood fight activities (Elliott 1932; Ferguson 1939; Moore 1972). The standard levee section that evolved was adopted by the MRC in 1947 and was the most stable profile based on a history of past flood events to meet the demands imposed by a Mississippi River-type flood. System performance has demonstrated that this standard section still needs engineering countermeasures in problem areas as well as the requirement to flood fight during major events. Levees have not typically been designed to the same standards as modern dams because of the economic considerations, (primarily the scale of levee miles involved), legacy construction history, and lower frequency of loading.

The design of a leak-proof system with no seepage is economically unrealistic for a Mississippi River-scale system because of the pervious foundation geology (i.e., point bar deposits). Economic decisions determine the ultimate cost and the value of the land area behind the levee system. Similar experiences have occurred in other drainage basins in the United States in terms of the standard levee section that was adopted for these river systems. The Mississippi River system is not unique in the United States in terms of the requirement for flood fighting. The legacy of most levee systems is to contain a flood to the design height, which is an economic decision by the local residents and governing authorities. These legacy systems were never built to the same standard as high-hazard dams or at the costs associated with the design of these dams. The legacy of river commerce and flood-control improvements in the different drainage basins across the United States is described by Billington et al. (2005) and Reisner (1986). These histories reflect the individual patchwork of development in these different drainage basins and demonstrate the challenges of using remote sensing methods for evaluating levee performance because of legacy decision making and unique history in the respective watersheds.

3.5.6 Remote sensing challenges

Challenges involved in remote sensing of internal erosion of levees and the foundation during flood conditions are significant and many. These challenges include the optimal image resolution needed to identify small to large sand boils, the ability to detect movement of soil particles or sediment turbidity, the repeat frequency of the sensing platform to ensure an adequate detection cycle of poor performance, the ability to discriminate in near real-time significant boil activity from normal background seepage, the ability to penetrate heavily vegetated areas and tall grass, and capability to identify soil-softening conditions before the onset of a slope failure at the levee toe from prolonged seepage. This list of requirements has significant technological challenges to meet the demands of real-time flood monitoring and requires detailed knowledge of the flood system. The geology of each river system is unique, along with the different types of depositional environments that are present and recognition of those that have significant underseepage potential.

The use of berms, seepage blankets, and relief wells to reduce exit gradients in problem geologic areas has added complexity and challenges for detection of poor performance by remote sensing methods (Figure 3-7).

Landside drainage ditches are often used to control surface drainage and groundwater flow from relief wells. The requirement for impervious berms and seepage blankets generally shifts the location of boil activity to the end of the berm or drainage blanket where thin top stratum conditions representative of the reach are again encountered. The construction of a maximum 300- to 400-ft-wide berm, in areas where the exit gradient at the levee toe is larger than 0.8 typically does not reduce the potential for boil activity at the end of the berm. The intended purpose of the berm was to lengthen the seepage path, thereby shifting the problem to a safe distance landward of the toe, and reducing the potential for piping and failure in the vicinity of the levee toe, but flood fighting of these boils is still required.

Remote sensing methods can aid with identifying these problem areas. Spaceborne and airborne imagery have been favored because of the economy of scale involved in large river systems but have historically lacked spatial and temporal resolution capable of identifying small sand boils during major flood events.

However, historic aerial photography has been an especially important component of legacy remote sensing in mapping of geologic features on the floodplain. Geologic mapping of the Mississippi River Alluvial Valley and floodplain was accomplished primarily by historic aerial photography to identify depositional environments, their horizontal and vertical limits, and the soils that form these environments. These mapping studies have guided geotechnical investigations of problem areas and their remediation, and provided an important foundation for environmental based studies of the floodplain. Saucier (1994) provides an in-depth account of the geologic studies that have been conducted and their relationship to engineering in the Lower Mississippi River Valley.

3.5.7 Importance of LIDAR data

An especially effective method for predicting and understanding sand boils involves high resolution LiDAR datasets from point bar deposits. A view of the Mississippi River levee at Eagle Lake, MS, is presented in Figure 3-8 and serves as an example of the importance of this type of dataset to identify ridge and swale topography. This topography was identified as being problematic for sand boil formation by USACE in 1956 (Figure 3-3). Figure 3-8 is a view of the levee at Eagle Lake from airborne imagery, while Figure 3-9 is the same scene except as a LiDAR image of surface elevation. The LiDAR data are used to identify subtle changes in surface

elevation across the floodplain, and shows the ridge and swale topography that is present behind the levee toe in Figure 3-8. The change in elevation across profile A-Á is presented in Figure 3-10. Ridges correspond to the lateral sand bars that are formed as the channel migrates. These locations can create problems where the blanket is thin. Because of the intervening swales, abrupt changes in substratum permeability occur, and the ridges are pathways for concentrated seepage (Figure 3-3).

3.5.8 Vegetation control and remote sensing applications

Low-lying areas behind the levee are oftentimes poorly-drained swamps. Woody vegetation growth impedes the ability to detect active boil formation under tree canopies by either satellite or airborne imagery. Additionally, drainage ditches behind the levee are normally overgrown with trees and make inspection difficult. Roots from woody vegetation may penetrate through thin blankets and can further contribute to seepage issues. Early vegetation policy and control by the MRC is described by Elliott (1932) and is known to contribute to poor system performance and the ability to flood fight sand boils. Consequently, the practice of controlling woody vegetation growth along the levee right-of-way was established to better detect areas experiencing problems and effectively flood fight these areas.

Figure 3-8. Aerial image of levee reach at Eagle Lake, MS. LiDAR elevation imagery of the same area is shown in Figure 3-9.



Figure 3-9. LiDAR image of levee reach at Eagle Lake, MS. Lower elevation correspond to higher intensity purple. Note the ridge (blue) and swale (purple) topography along the levee north of the Eagle Lake oxbow Profile A-Á is presented as Figure 3-10. Note that borrow pits are visible along the flood side of the levee toe, which are potential entry points for seepage.

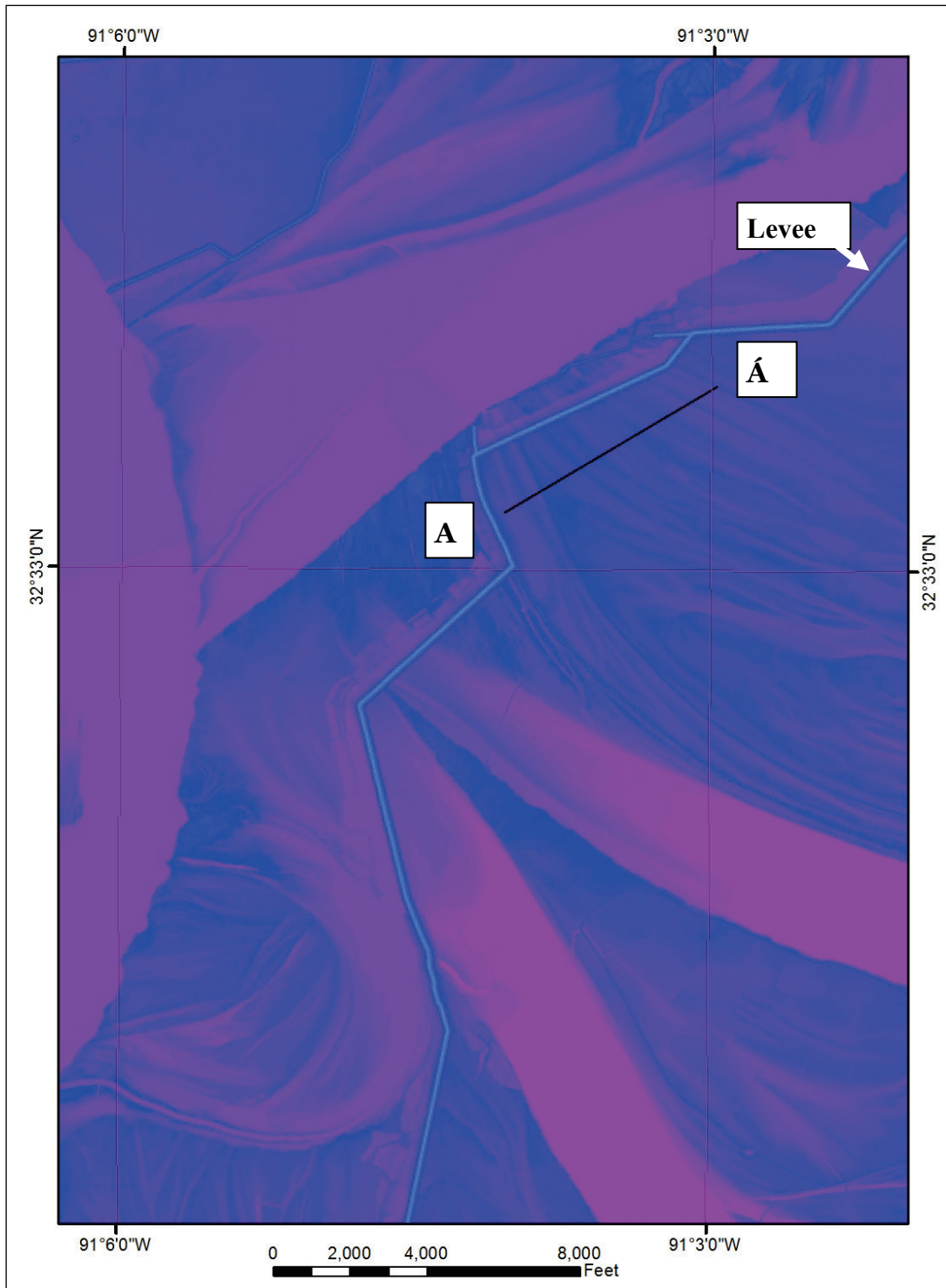
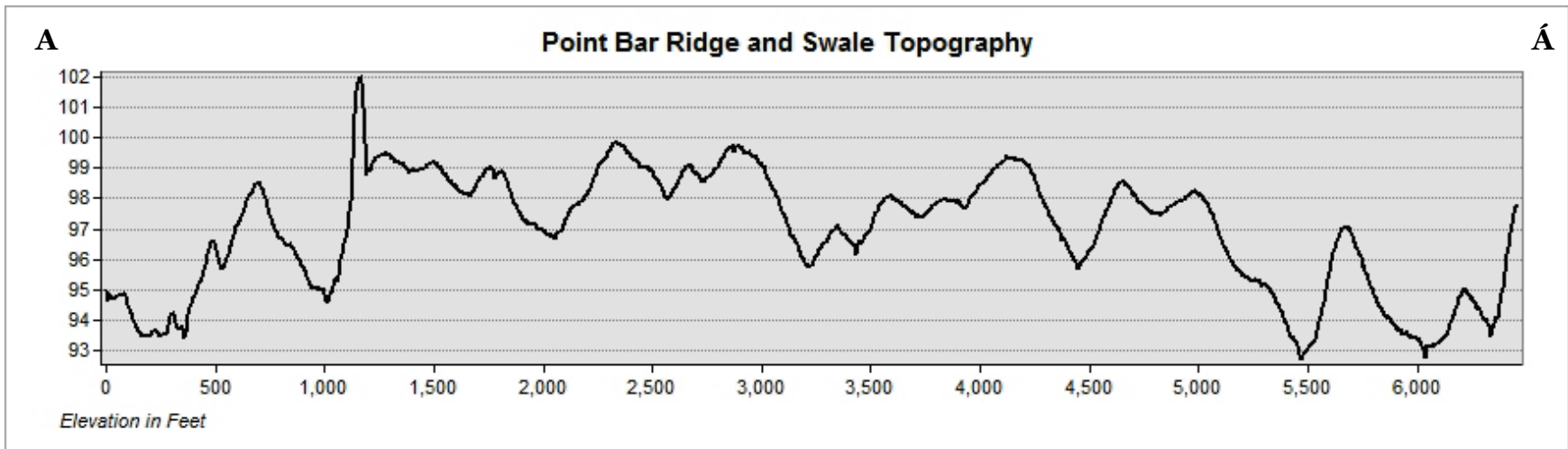


Figure 3-10. LiDAR profile from Figure 3-9 that shows changes in elevation across the ridge and swale topography that is diagnostic of point bar deposits. This variation in elevation can impact levee underseepage and boil activity at the levee toe.



Remote sensing is especially useful for monitoring vegetation growth and ensuring that levees meet USACE policy for vegetation growth in the levee right-of-way. Google Earth imagery provides an easy inspection capability and tool for monitoring vegetation on levees, especially as the imagery is periodically updated.

3.5.9 Thermal IR applications

Sensors in the thermal IR portion of the EM spectrum (Figures 2-2 and 2-3) are considered to be useful for detection and monitoring of boil activity as temperature differences in water from seepage are easily measurable. Differences in water temperature should exist between the sand boil pipe containing groundwater flow and the nearby standing water. Forward-looking IR (FLIR) technology on helicopters has been successfully used in locating active sand boils during the 2011 Mississippi River Flood (Woerner 2012). The author was told many years ago of a similar experience by Army National Guard personnel using FLIR onboard helicopters in flood rescue missions in California during flooding in the 1990s. Levees experiencing problems had a different thermal signature than non-distressed levees. Thus, targeted helicopter inspections with onboard FLIR are an effective technique to identify temperature variations and thermal signatures at the landside toe (Figure 3-4). Further study is needed into the spatial resolution for boil detection and the ability to integrate these data into an effective enterprise-GIS of flood fight.

Ideally, remote inspection using thermal imagery should involve a pixel resolution of 1 m or better. A pixel resolution of at least 10 to 20 cm for inspection purposes is desired for locating small features (Figure 2-5). Change detection strategies incorporating thermal data are especially attractive to monitor subtle changes in boil activity through time. This type of assessment should be linked to a targeted understanding of the system geology, where blanket thickness, and other information about the soils in the depositional environments are known.

3.5.10 Need for instrumented monitoring

Remote sensing of the land surface by satellite and airborne methods does not easily permit understanding of changes in the pressures in the interstitial pores, the flow of water through the interstices of the media, and/or the change in material properties of the aquifer media during the flood cycle. Satellite and airborne methods previously described involve

only the surface expression of levee distress and performance. Understanding of internal erosion by remote means requires the installation of internal sensors to measure changes in water elevation, pressure, and the gradient across the landside slope to a point where the piezometric surface intersects the ground. Observation wells, point sensors, and geophysical arrays can be installed along a transect or profile that encompasses the channel, riverside levee slope, crest, landside toe, and an extended distance beyond the levee toe to observe and record the change in important engineering variables (including but not limited to temperature, water elevation, velocity, pressure, and resistivity) over the entire flood event. Performance monitoring involving multiple flood events and any subsequent deterioration of hydraulic conditions at lower flood stages would be possible with this type of comprehensive monitoring.

This type of empirical research was used in the study of the Mississippi River point bar sites to develop the analytical solutions used today in blanket theory (HQUSACE 2000; Mansur et al. 1956a, 1956b). Unfortunately, observation points used to develop the blanket theory method in 1956 have long since been abandoned or destroyed. A new generation of “smart sensors” and technology is needed in problem reaches to improve our understanding of the seepage process, identify cyclic changes that occur with repeated floods, and develop better detection and prediction tools.

An important long-term component of the monitoring process should involve research into changes in the foundation properties with repeated flood cycles. Multiple flood events may flush fine-grained soils from the soil matrix and cause lower flood stages for the boil activity to occur. This phenomenon has been proposed for the Mississippi River. Impacts from long-term and repeated flood events need to be better understood and quantified to the extent possible. A monitoring program using internal sensors could provide much needed data on system deterioration and performance.

The concept of monitoring involves not only the suitable technology to identify poor performance but the targeted application of this technology to areas behind the levee that ensure correct understanding and resolution of the geotechnical problems. Intelligent monitoring using a GIS-based approach is favored. This approach requires knowledge of the foundation conditions a priori (e.g., environments of deposition, blanket thickness, boring data), engineering countermeasures present (e.g., levee design,

slope, age, previous performance issues, location of relief wells, berms, blankets, drainage ditches) and other related information to aid with monitoring and decision-making. Internal monitoring technology will be discussed in more detail in Chapter 4 of this report.

3.6 Slope failures

3.6.1 Failure mechanisms

The final mechanism involves global stability failure of the levee or its foundation under the influence of gravity. Two main categories of slope failure are involved: failure occurring in the body of the levee only and those involving the foundation, and/or combination of the levee and foundation. HQUSACE (2000) describes that the principal methods used to analyze levee embankments for stability against shear failure assumes either (a) a sliding surface having the shape of a circular arc with the foundation and/or the embankment or (b) a composite failure surface composed of a long horizontal plane in a relatively weak foundation or thin foundation stratum composed of a long horizontal diagonal plane surface up through the foundation and embankment to the ground surface. Understanding and recognition of conditions that promote instability in levee embankments are required for targeting specific imagery and geophysical methods for remote inspection and persistent monitoring.

Failures involving the foundation are described first. The location of the levee with respect to the river channel is an important consideration for this type of failure mechanism. The land area between the toe of the levee and the edge of the river channel is often called a bench, buffer zone, or batture (term used on the Lower Mississippi River Valley). Ideally, a broad buffer zone should exist between edge of the channel and the toe of the levee to permit space for channel erosion. Unfortunately, in many river systems the levee is located at the edge of the river channel. Levees located immediately adjacent to the riverbank, where no buffer or batture is present and the riverbank is part of the levee slope, are especially vulnerable to foundation slope failures because of scouring in the channel. This condition is especially problematic for many U.S. river systems where man's activities have constricted the natural floodplain to a narrow corridor.

3.6.2 Legacy levees

Three examples are briefly described here, which demonstrate slope stability impacts in legacy levee systems. The history of hydraulic gold mining in California has affected the Central Valley by requiring levees to be built adjacent to the Sacramento River in order to efficiently move coarse sediment derived from historic mining activities through the system and prevent the channel bed from aggrading. This levee system protecting the Sacramento area functions in combination with an upstream bypass of a design flood event to protect the densely populated urban area downstream. Consequently, the river receives only a percentage of the flood flow through the densely populated urban corridor. Erosion of the channel banks remains a major concern during flooding, and the current design of the system does not allow for a levee setback through a narrow urban river corridor. Hardening of the riverbank with rock is required to maintain the current alignment. This narrow floodplain corridor has created major environmental issues with riparian woody vegetation on levee slopes and subsequent impacts to engineering, maintenance, inspection, and flood fighting.

Similarly, in many parts of the country shortening of the river channel by channelization and rectification has created a restricted floodplain corridor that is only large enough to accommodate the design flood event. The middle and lower Rio Grande in the vicinities of El Paso and Brownsville, TX, are examples of this type of situation. During the 1930s, both governments of the United States and Mexico constructed a narrow floodway corridor through the El Paso area, including a central pilot channel that serves as the official border. An important consequence of restricting the flood flow to a narrow floodplain corridor is the capacity of the system to accommodate the volume of water during a design event, especially due to land-use changes in the flood corridor. This narrow corridor requires effective floodplain management to prevent excess erosion, unwanted vegetation growth, and undesired land-use changes. In the Brownsville area, environmental concerns in the 1990s have limited vegetation management strategies in the floodplain corridor, which were part of the original hydraulic design assumptions. Consequently, parts of the levee system need to be rebuilt to higher elevations to safely pass a 100-year event. Changes in vegetation alone or other major land-use impacts within the flood corridor can have serious consequences to system capacity, reliability, and levee safety.

The last example highlights unmanaged vegetation growth that occurred in the “Great Trinity Forest,” downstream of the Dallas Floodway corridor, which has significantly reduced the ability of the system to pass a design flood event (Furlong et al. 2003). These examples are not unique but serve to highlight critical issues affecting legacy flood protection systems and the need for understanding the legacy design. The requirements for continued monitoring, inspection, and maintenance of these systems ensures that they function as intended for public safety. Remote sensing methods are especially useful for effective surface monitoring of hydraulic capacity issues and evidence of slope stability issues. Specific features of the failure process are further described here to provide better understanding of monitoring strategies.

3.6.3 Geology of foundation slope failures

A natural condition for any river system is for the bank to migrate laterally across its floodplain unless bank stabilization, hard points, and grade-control structures are adopted to prevent both horizontal and vertical movements of the channel. A narrow floodway corridor severely limits the river’s potential for movement due to the absence of a buffer zone. Additionally, changes in hydraulic capacity due to vegetation growth, land-use, transportation infrastructure (e.g., bridges for highways and railroads, utility crossing), tributary intersections, or other potential choke points will need to be considered in any evaluation of levee stability against slope failures and/or overtopping with remote inspection and monitoring. River channels that are located immediately adjacent to toe of the levee are especially vulnerable to erosion and deep-seated scouring of the levee toe and possible failure from an over steepened bank. Maintenance is a central requirement for these legacy systems. Satellite and aerial remote sensing and visual inspection can ensure that maintenance activities are being performed and help target areas at risk from stability issues. Additionally, evidence of distress and signs of unsatisfactory performance require documentation and reporting for preventive maintenance.

Meandering rivers by their very nature will tend to erode the concave or cut bank as shown by Figure 3-2. Erosion of the river channel by this mechanism creates point bar deposits and abandoned channels or oxbows on a river’s floodplain. River systems that display oxbows and multiple abandoned channel loops connected to form an abandoned river course are candidates for slope stability issues. Engineering countermeasures against bank erosion include grading of the bank, armoring of the graded

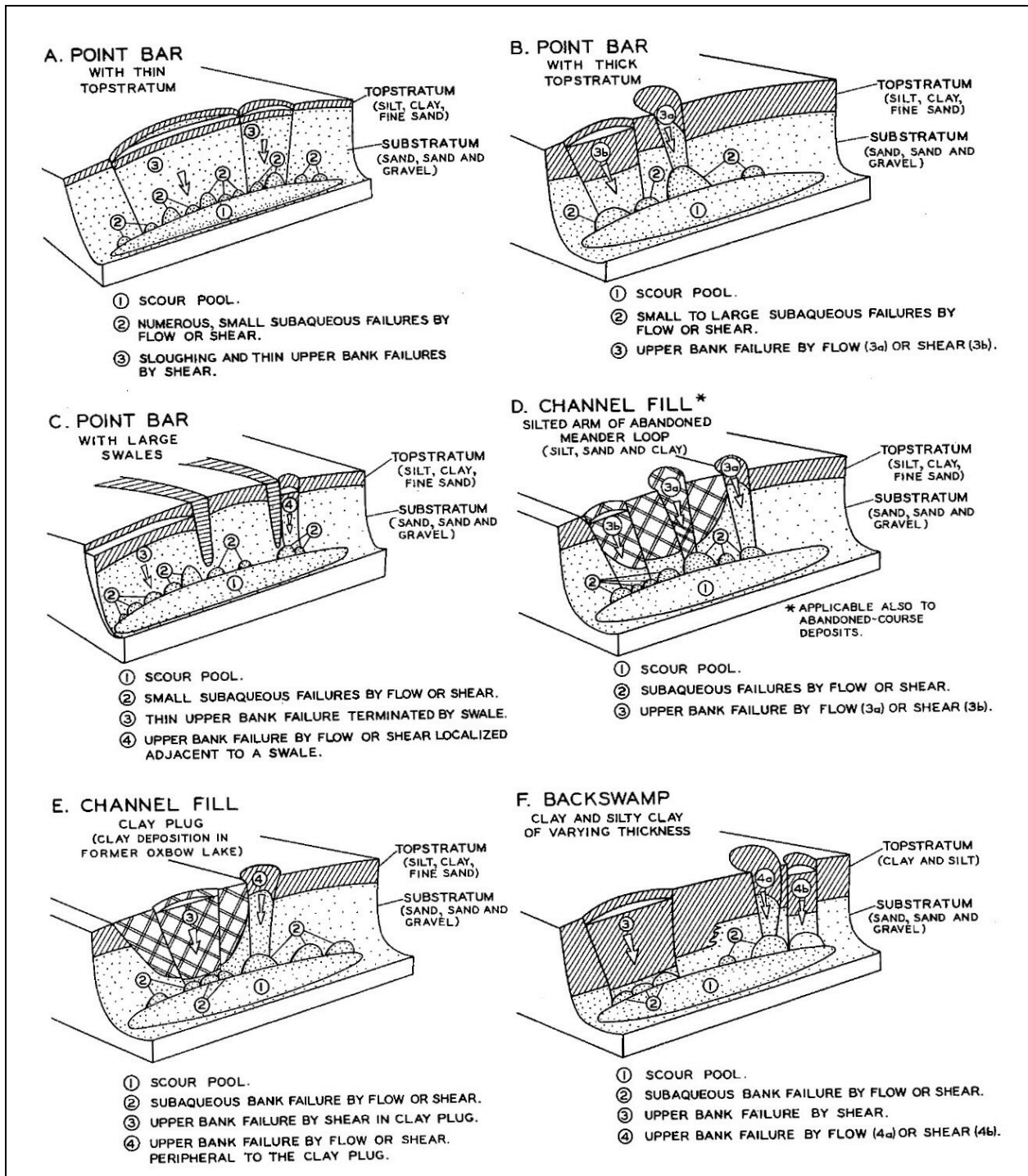
riverbank slope with rock and revetment, and constructing control dikes and jetties to shift the thalweg or trace of the deepest point in the river channel away from the bank.

Levee setbacks are sometimes required to create a buffer zone, or batture lands, to protect the levee from direct attack by the channel. However, the latter may not be possible in urban settings as previously described because of historic decisions, border issues, land-use, and real estate considerations.

Bank caving is normally a two-part process, especially in point bar deposits. Erosion in the channel bendway causes oversteepening of the concave riverbank. Deep scouring of the foundation sands is subsequently followed by shear failure of the upper bank (i.e., the cohesive top stratum), as the weight of the upper bank cannot be supported following loss of the underlying sands in the foundation. The magnitude of the upper bank failure varies according to the specific type of floodplain depositional environment present and the thickness of the cohesive top stratum blanket. Depth of scouring and top stratum thickness affects the linear extent and shape of the failure (Figure 3-11). This condition is troublesome in older point bar deposits, especially those involving large meandering river systems, where the channel and bank extends into older sandy deposits. Rivers will naturally migrate across their alluvial valleys and create a floodplain composed of abandoned river channels and older meander belt deposits. Armoring or “hardening,” of the riverbank is required to prevent undesirable movement, especially where the buffer zone, or batture, between the top bank of the channel and the levee toe is either absent or insufficient.

Slope failure can be problematic to both channel banks and levees after a prolonged high river stage. Deep-seated scouring in the foundation sands followed by a rapid drawdown of the river can often lead to an upper bank failure that may also result in a levee failure if there is insufficient batture. This condition occurs as the water level in the channel drops faster than the soil can drain after loading (HQUSACE 2000). Shear failure of the upper bank occurs due to the saturated weight of cohesive soils under the influence of gravity. The Marchand levee failure in south Louisiana in 1983 is an example of this condition (Dunbar and Torrey 1990). Shallow slides may also occur in the levee section itself following a rapid fall in the river after prolonged periods of floodwater being against the riverside slope of

Figure 3-11. Environments of deposition and mechanics of bank failure in Mississippi River alluvial deposits (Krinitzsky 1965).



the levee. Ordinarily, this type of failure mechanism is not threatening to life and property because it develops and occurs after floodwaters have subsided. However, should the river stage rise again before repairs can be made, the force of the water acting on the failed levee surface may exceed

the resistance offered by the degraded levee section and may possibly lead to failure.

3.6.4 Remote monitoring and inspection of deep failures

Remote sensing methods using current high resolution satellite and airborne imagery are effective tools for identifying unstable areas as the bankline of the channel will display a “scallop” appearance of the river-bank, indicating the incidence of slides (Figure 3-11). The presence of fresh erosion surfaces, downed trees, and slumping of the bank and/or levee surface can easily be observed with remote methods and post-flood imagery. Ideally, high resolution imagery of at least 1- to 2-m resolution is needed to observe these features.

Comparison of historic hydrographic surveys and bank lines from historic imagery and maps can be used to identify locations that are susceptible to chronic bank erosion. Change detection from historic hydrographic surveys, imagery, and maps is easily accomplished with GIS technology.

Google Earth imagery provides a rapid desktop method to assess levee and channel reaches and identify potential problem areas based on signs of instability in the imagery and vegetation changes between imagery coverages. Historic maintenance funding spent to protect and armor the bank, or the lack thereof, is another easy method to evaluate channel bank problem areas. Chronic channel bank stability problems are typically related to a combination of factors involving geology, composition of the bed and bank, location and orientation of the river current with respect to the bank, and/or lack of preventive maintenance. The same can generally be said for chronic problems with levee slope stability, especially when floodwaters are against the riverside slope of the levee.

3.6.5 USACE monitoring examples

USACE districts in the LMV have routinely conducted inspections of river-bank stability during the past decade with low altitude helicopter surveys incorporating digital imagery with integrated GPS technology and LiDAR (Gutshall 2012; Red Hen Systems, Inc. 2013; Fugro 2005). The purpose for these low altitude airborne surveys is inspection and/or elevation measurement of the upper riverbank. Inspection items include evidence of distress, the condition of control dikes, the presence and condition of rock armoring and revetment, vegetation maintenance requirements, and noting

changes in slope and geometry from previous inspections. Both Dutch and French levees are similarly surveyed with high resolution airborne LiDAR to provide levee geometry and elevation data (Franken and Flos 2005; Royet 2012). Studies of levee geometry using high resolution LiDAR data have been performed on the Rio Grande by Dunbar et al. (2003) and Dunbar and Llopis (2005) for the IBWC and by the California Department of Water Resources (CDWR) using GIS decision-based methods to screen the levee right-of-way and identify reaches not meeting criteria (Casas et al. 2012).

Helicopter inspection surveys incorporating high resolution LiDAR and digital imagery have been combined with bathymetric surveys by USACE and CDWR (Rawson 2013, personal communication, New Orleans District; Mitchell 2012; Woldring et al. 2012). These integrated surveys provide a complete profile of the levee slope, the buffer zone, and extend to the thalweg of the river to assess slope geometry and stability. The integration of high resolution airborne digital imagery and precision LiDAR surveys for levee inspections has been limited mainly to state and federal agencies, due to the high costs associated with these surveys and the regional extent of their levee footprints. These high resolution types of surveys are not ordinarily performed on smaller scale levee systems managed by county and local governments due to their costs for surveying.

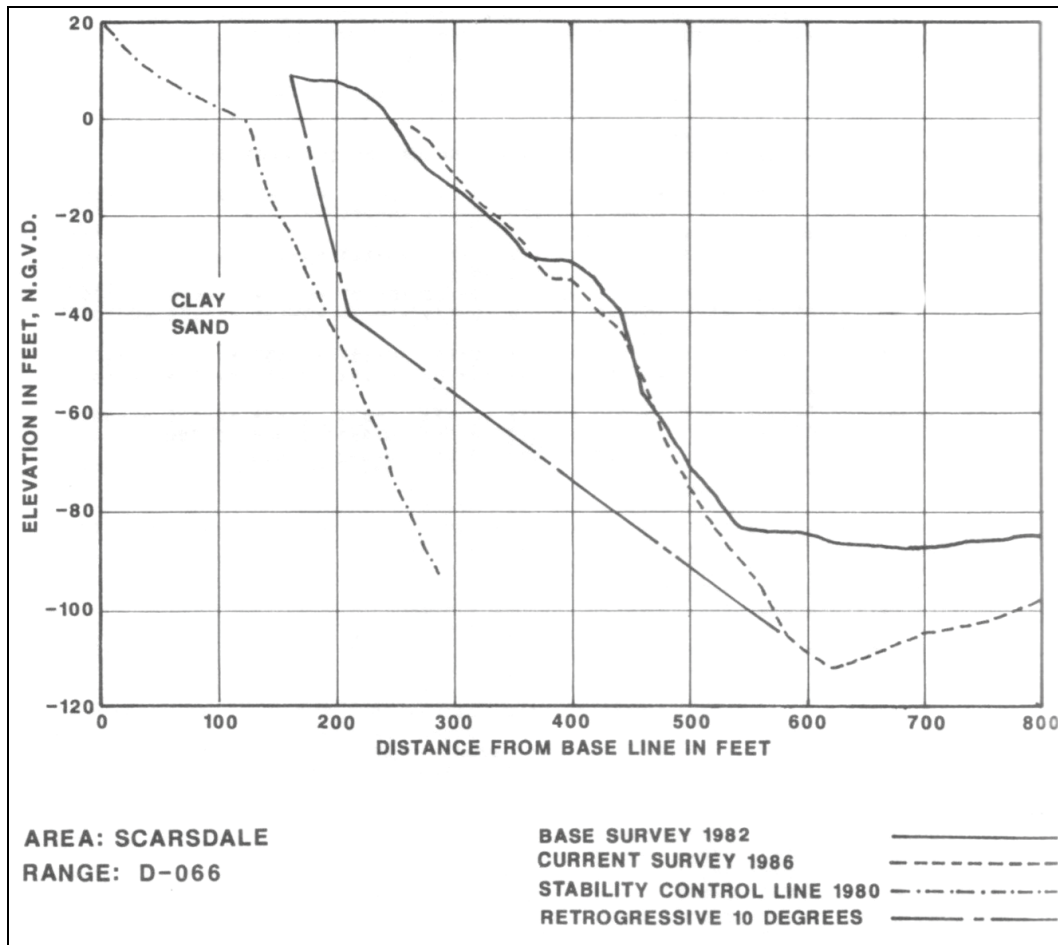
Hydrographic surveys of larger river systems are usually conducted annually. Bathymetric surveys of the Mississippi River have been routinely conducted to identify scouring and erosion of the channel and banks, determine channel geometry changes, assess the need for revetment and rock armoring, and as part of the hydrographic survey record of the river that are published every 10 years. Hydrographic surveys of the Mississippi River have been published on a roughly 10-year cycle, since 1880 with the formation of the MRC (see https://inet.mvd.usace.army.mil/GIS/MRC_Maps/main.html for historic coverages). These surveys provide a long-term perspective of channel migration and identify chronic stability areas along the river. For levee stability of large river systems involving navigation, annual channel surveys are an important component for monitoring riverbank migration, which helps prioritize the annual maintenance funding to critical areas. Most navigable river systems in the United States have periodic hydrographic surveys of these systems and/or National Oceanic and Atmospheric Administration (NOAA) bathymetric coverages at the mouth of these waterways along the coast. However, hydrographic surveys of smaller, non-

navigable river systems are typically not done unless the sport fishing industry provides these products.

With respect to coastal zone bathymetry and engineering, the fusion of airborne LiDAR data with surface topography in the coastal zone in the Gulf of Mexico has been successfully used by USACE since 1994 (Sylvester 2012; Reif et al. 2011). Various airborne systems have been developed by USACE to provide bathymetric data of the coastal zone and are described by Sylvester (2012). These systems include SHOALS (Scanning Hydrographic Operational Airborne Lidar Survey System), CHARTS (Compact Hydrographic and Rapid Total Survey System), and CZMIL (Coastal Zone Mapping and Imaging Lidar). The evolution of coastal zone mapping by these airborne systems has fused LiDAR elevation data and hyperspectral imagery to support both physical and environmental characterization, as well as coastal engineering applications (Reif et al. 2011). However, the principal focus of these efforts has been monitoring coastal bathymetry, shoreline changes, barrier island movements, and navigation impacts in coastal estuaries and channels, as opposed to mapping levees and their potential stability issues. Storm surge modeling and hurricane inundation impacts to populated coastal areas have been a primary benefit of this research.

In terms of river stability engineering, annual hydrographic surveys have been successfully used by the different USACE districts on the Mississippi River to monitor channel and levee stability. The evaluation process involves annual comparisons of channel and bank topography at fixed locations. Contained within historic hydrographic survey data are evenly spaced survey transects across the river that are referenced to river mile. These perpendicular river transects are known as range lines and measure the topographic profiles of the riverbed at right angles to the channel bank. Surveys at these range lines are compared to a computed stability control line (SCL), based on available boring information of the soils in the bank and a bank stability analysis, to derive the SCL. Range lines are monitored during the yearly survey to determine erosion below the SCL in Figure 3-12. This profile is from the Scarsdale revetment (left bank, range D-066) and compares stability control line (SCL), retrogressive control line (RCL), historic (1982 and 1986) annual low water hydrographic surveys, and elevation of topstratum/substratum contact. The slope of the RCL impacts levee stability when it intersects the SCL, otherwise it impacts only the batture.

Figure 3-12. Example profile from the levee flow slide monitoring system in the USACE New Orleans District for determining Mississippi River bank stability (Torrey 1988).



Annual hydrographic surveys are used to determine whether the channel bank profile is steepening, and/or moving toward the cut bank side of the channel. Riverbank maintenance in problem reaches may include additional revetment protection, protective armor stone, grading of the top bank, rebuilding the bank, or as a last alternative, a levee setback in severe erosion areas. Channel scouring during high water can steepen the riverbank beyond the safe limits identified by the SCL and leads to planned preventive bank maintenance at this location. Historically, yearly bathymetric surveys have been used to determine revetment damage and requirements for new revetment. Studies of bank stability along the Mississippi River indicate channels will oftentimes narrow and deepen in hardened river reaches before failure occurs. Annual monitoring of river bendways can easily identify these narrower locations by remote sensing methods.

Sjostrom et al. (1998) used geophysical methods in detecting revetment loss. Their study in the vicinity of Baton Rouge, LA, in the Mississippi River, successfully demonstrated the use of multi-frequency EM methods as a monitoring tool for targeting the metal rebar contained in the concrete revetments to monitor the movement of the revetment downstream due to scouring and erosion. Further research needs to be performed to better develop geophysical techniques for tracking stone loss and revetment movements. A potential monitoring technique involves selective tagging of revetment and armor stone with conductive signatures or “bright spots” to permit automated tracking in problem areas.

3.6.6 Shallow type slides

The second category of stability problem in levees involves shallow slides in levees and/or the shallow foundation where clay levees are composed of highly plastic clay (CH) related to changes in soil moisture and volume. Especially problematic are clay soils that are dominated by a uniform grain size distribution and specific clay minerals. Based on their internal molecular structure, clay minerals classify into one of three clay families or groups: kaolinite, illite, or smectite. This molecular structure relates to the stacking of sheet or plate-like alumino-silicate minerals and associated cations (Na, K, Ca, Mg, and Fe) on the sheet surface and within the crystal lattice of these sheet structures. Smectite is well known by engineers and geologists because of its high shrink-swell properties. Montmorillonite is a member of the smectite family and one that is commonly associated with engineering problems involving expansive soils.

Borrow pits located in low-energy floodplain settings (e.g., backswamp, inland swamp, flood basins, abandoned channels) that receive only very fine-grained sediment during the annual flood cycles are prone to expansive type soils. County soil survey bulletins of the United States by the USDA contain valuable information about soil types and their shrink-swell properties. This information is readily available in a digital format and easily accessible through GIS capabilities to identify borrow pits used in levee construction that are prone to expansive soil issues.

Shallow slides can develop in steep levee slopes composed of uniformly, highly plastic clay, especially during hot summer months when rainfall is at a minimum. This situation is especially problematic in the central and western states where prolonged drought conditions often occur, the rainfall is not evenly distributed, levees are founded of CH, and levee

slopes are typically steep, with slopes of 1V to 2.5 to 3H. Sources of borrow material used to build the levee and the underlying geology are important factors in predicting performance for these situations. Levees are normally built from nearby floodplain sources. Favored borrow pit locations in alluvial settings are abandoned oxbows, backswamps, inland swamps, flood basins, natural levees, and/or fine-grained top stratum derived from point bar deposits.

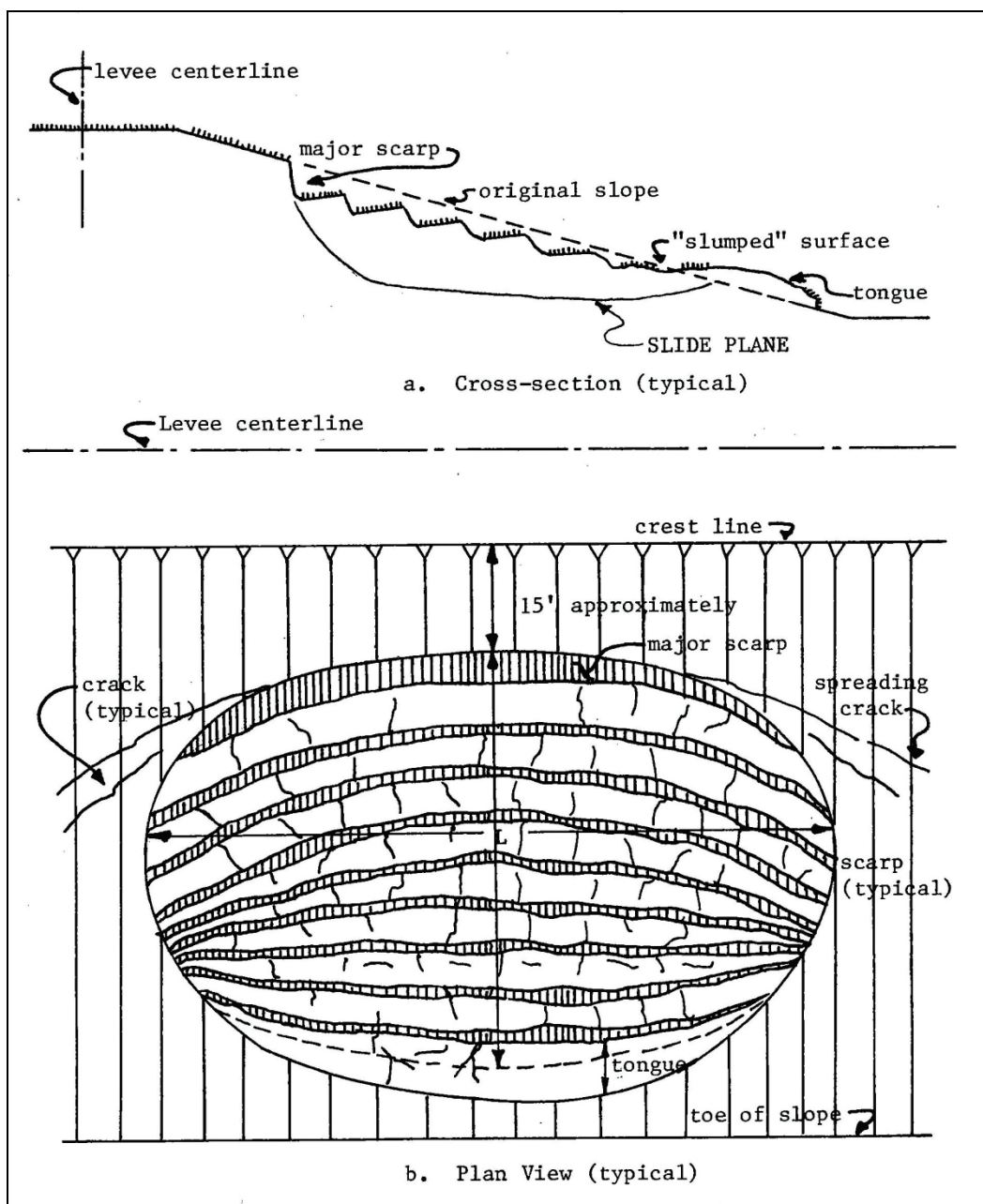
Engineering studies of shallow slope failures involving levees constructed of CH soils were conducted by the USACE Vicksburg District (Sills and Templeton 1983; Spencer-Associates 1980). Especially problematic were levees built of clay from the Lake Albermarle area, an abandoned Mississippi River oxbow. Clay soils with a plasticity index (PI) greater than 40 are prone to shallow sliding and require lime treatment of soils from these areas to ensure stability. Slides typically occur on the steeper riverside slope (1V:4H), between the riverside crown and a point midway on the slope, and range in length from 200 to 300 ft (Figure 3-13).

The failure cycle involves desiccation and cracking of the levee soils during hot summer months, when precipitation is typically absent, followed by higher fall and winter precipitation, which hydrates the soils and longitudinal tension cracks that develop failure plane surfaces. The spatial location of these slides indicates borrow pits in abandoned channel settings with uniformly fine-grained CH soils are especially prone to be associated with locations where shallow slides develop. Levees constructed of low plasticity soils and soils from higher energy fluvial environments tend to be more stable because of their wider (heterogeneous) grain-size distribution.

3.6.7 Remote monitoring for shallow slides

L-band SAR and satellite remote sensing using commercial imagery have been used to screen for shallow levee slides along the Mississippi River in the USACE Vicksburg District (Aanstoos et al. 2011, 2012a, 2012b; Hossain et al. 2006). These techniques are typically performed in the dry season due to soil moisture issues using radar and/or during leaf-off season for imagery based media. These research efforts have been focused on using automated screening methods for classification of slide areas.

Figure 3-13. Shallow slough slide that is typical in the USACE Vicksburg District (Spencer-Associates 1980): (a) cross section and (b) plan view.

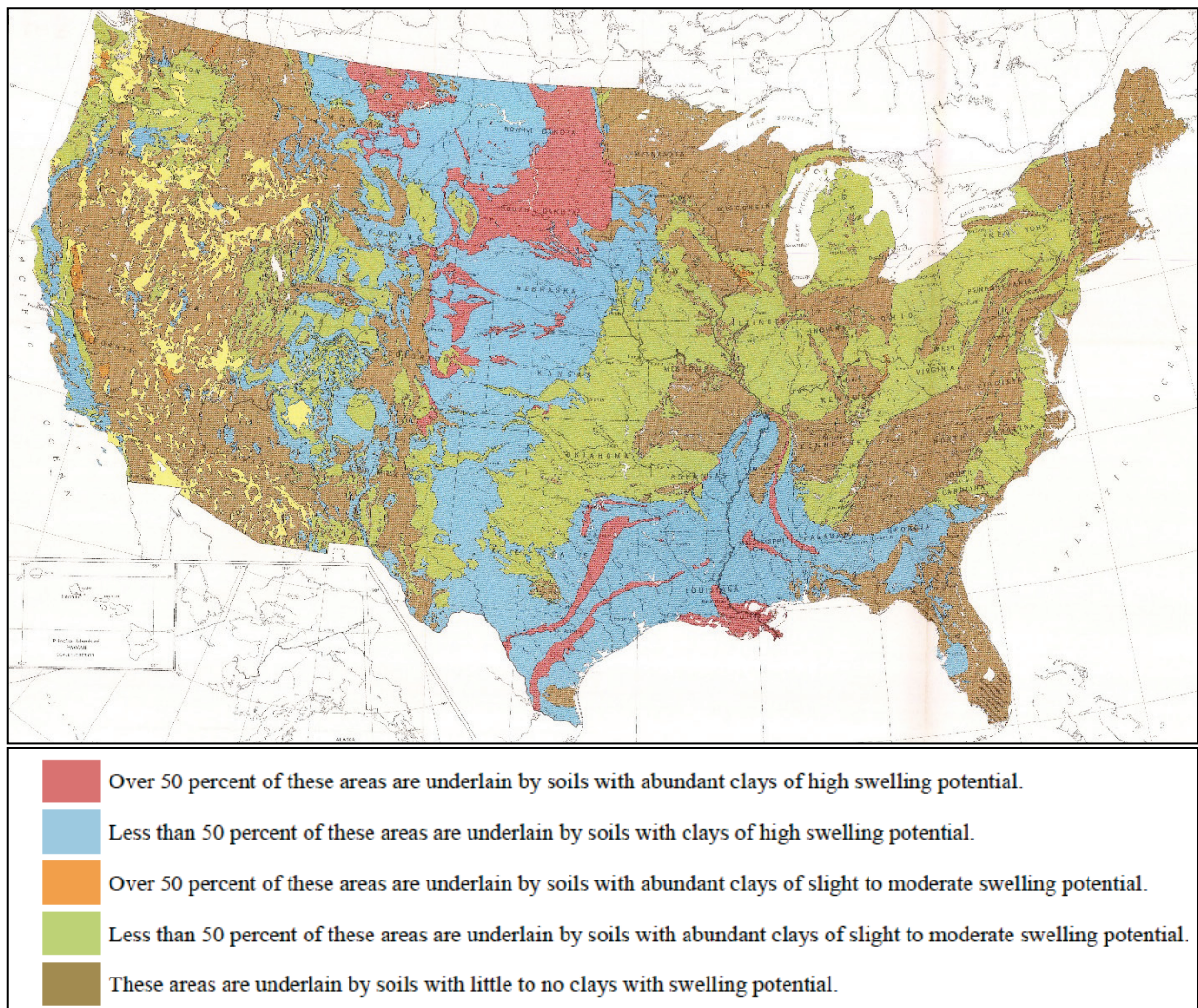


3.6.8 Climate and geology in shallow slide prediction

Levees located in areas underlain by shale and clay-shale bedrock and floodplains that cross these types of bedrock settings can be especially vulnerable to soil volume changes due to soil moisture loss, which creates levee instability problems. Especially problematic are the Cretaceous-age (145 to 65 million years) shale and clay-shales that outcrop in the central parts of the United States as shown by Figure 3-14 (Olive et al. 1989;

Federal Highway Administration 1977; Patrick et al. 1977). An example of stability problems associated with flood-control structures from this type of setting involves levees along the Trinity River in the Dallas-Fort Worth area that are derived from alluvial soils of weathered Eagle Ford Shale.

Figure 3-14. Map of swelling clays in the United States (Olive et al. 1988).



Levees built at steep slopes ($>1V:3H$) from alluvium derived from the Eagle Ford are prone to shallow slides after prolonged periods of drought and subsequent rainfall (USACE 1968; Branch 2007). The Dallas-Fort Worth area is especially noted for prolonged arid summer days that exceed 100°F . Thus, the combination of bedrock geology and summer droughts makes this area prone to shallow slides. Levee areas treated with lime and built to flatter slopes are less prone to these types of shallow slope failures. Branch (2007) describes the simultaneous occurrence of shallow levee

slides from expansive soils and a high precipitation rain event that produced flood conditions in the Trinity Floodway. Levee slopes built of expansive soils can be compromised by high rainfall and subsequent flooding. Levee performance data should be evaluated as part of any program involving remote sensing and monitoring methods to address levee stability for local issues associated with geology, hydraulic loading, construction, and system design.

End-of-construction type failures can be problematic for levees constructed in soft soil foundations that are impervious. Deltaic environments are especially prone to these type soils. Excess pore water pressure is present because the soil has not had time to drain since being loaded (HQUSACE 2000). The age of the constructed levee segment is an important consideration for shallow sliding of the embankment in these cases. Typically, subsidence issues may be involved in these settings because of the soft soil conditions. Monitoring for settlements is often performed as part of the construction process with staged construction if the situation warrants. Legacy systems are typically not affected by this condition as they have become stable through time. An important consideration for remote monitoring and inspection are the dangers associated with first filling, similar to concerns involving dams, and the lack of any historic performance data. This unique situation requires careful monitoring of settlements during the first 5 years following construction, and careful attention during flood loading, until a performance history has been established.

3.6.9 Summary

In summary, high-resolution imagery and LiDAR data are important components for remote monitoring and inspection for slope instability. High temporal frequencies are needed for effective screening using these data sets. Remote sensing surveys should target evidence of bank migration, downed trees, fresh erosion surfaces, bank slumping, and/or signs of shallow levee distress and sliding as examples. Ideally, LiDAR surveys of the levee and bank would be performed at a frequency of 5 years or less in problem locations.

Bathymetric surveys are an equally important component at locations where the river channel is adjacent to the levee slope and a buffer zone does not exist. Monitoring should target chronic problem reaches. Monitoring of hard points and the presence of control structures are important considerations for effective monitoring using remote sensing

methods. Understanding legacy issues, their past performance, and key aspects of the engineering geology (e.g., location of borrow pits, soil types, the presence of expansive soils, and rainfall conditions) are critical to any remote sensing strategy for levee stability.

Vegetation management is an especially attractive monitoring strategy using remote sensing incorporating imagery and/or LiDAR data. Google Earth imagery combined with desktop GIS technology is an important monitoring tool for performing basic levee system screening. Privately-owned or local and county government-owned levee systems that have been identified as being located within the 100-year floodplain by the Federal Emergency Management Agency (FEMA) (www.msc.fema.gov) can be screened with simple decision rules that are described in Chapter 4.

4 Inspection of Flood-Control Works

4.1 Introduction and USACE requirements

USACE has established minimum standards for construction, operation, maintenance and preparedness of federal levees and flood-control works (FCW), which includes flood-control structures, that must be met in order for the FCW to be eligible for federal rehabilitation after a flood (HQUSACE 2001, 2006a, 2006b). Inspection is thus a critical component of ensuring that the FCW meets these standards and logically forms the underlying basis for performing remote inspection and monitoring during both low water and flood conditions. The discussion of failure mechanisms in the preceding sections has described the primary factors of concern for the different failure modes. The application of an inspection process is targeted at meeting the needs of the initial eligibility screening, annual inspection, maintenance of the system, and for performance monitoring through time.

The USACE (2001, 2006a, 2006b) inspection process incorporates a rating of the different system components, which involves earthen embankments, floodwalls, mechanical structures, and the electrical components (i.e., pumps, motors, electrical and power systems) that compose the FCW. Inspection by remote sensing and monitoring methods is possible with current technology and should be readily incorporated for system-wide inspection of levee embankments and floodwalls. Both electrical and mechanical components of the system are not excluded, but they normally involve components that are housed in structures, which are not usually visible to remote inspection by either satellite or airborne methods. Covered-type systems require visual inspection and monitoring unique to those systems, which are not considered here. Relevant inspection items for embankments and floodwalls are contained in Appendix B of EP 500-1-1 (HQUSACE 2001) and Appendix C of the Levee Owner's Manual for Non-Federal Flood Control Works (USACE 2006b).

4.2 Civil engineering management program

The checklist contained in EP-500-1-1 for rehabilitation assistance has three levels of assessment (i.e., satisfactory, marginally satisfactory, and unsatisfactory) on 39 critical items used in rating a FCW. Items 1 through 19 involve the level of protection, erosion control, embankment soils,

foundation soils, structures, depressions, erosion, slope stability, cracking, animal control, unwanted vegetation growth, encroachments, riprap/revetments/banks, stability of concrete structures, concrete surfaces, structural foundations, culverts, gates, and closure structures. Items 20 through 39 involve other factors, such as presence of motors, their power requirements and sources, pump size, and corrosion of metallic items, existence of operation and maintenance manuals, safety plans, communication plans, operation of cranes, intake and discharge gates, and other safety considerations. Remote sensing methods can greatly aid with the inspection process, primarily in items 1 through 19, and in identifying and locating system components, and determination of conditions of many of these components, depending on the spatial and temporal resolutions of the imagery used. The entire checklist from EP-500-1-1 is included in Appendix B of this report for reference.

The inspection checklist in EP-500-1-1 measures the entire FCW as a single system for the initial screening and eligibility for federal assistance funding for rehabilitation. Individual aspects of the system are rated for a cumulative score or assessment of the FCW. This type of rating method is useful in that the critical components are broadly identified and the entire system is rated according to the primary factors considered in the assessment process. The length of the rated levee reach being scored is not a concern in the rating process, which can extend many miles in length. Thus, the length of the rated levee segment unit is usually tied to a management decision regarding project authorization, construction history, system age, levee district, type of levee (i.e., agriculture versus urban) or other arbitrary division, as opposed to specific features involving the foundation geology, geologic boundaries, geotechnical reaches of similar engineering properties, or ranking of smaller subdivisions according to potential failure modes along the rated reach.

Ideally, the levee should be subdivided even further into smaller subdivisions and evaluated using all of these different breakdowns and incorporating remote sensing methods where applicable. These data would be managed using an enterprise GIS during the assessment and initial inspection and subsequent periodic inspections. The result of this refinement would be smaller scale subsystem reaches with performance or stability issues identified, foundation and embankment properties defined, and assessments of their respective risk for the likely failure modes possible.

4.3 Levee owner's manual for non-federal flood works

The checklist contained in Appendix C of the levee owner's manual (USACE 2006a) is more complete and specific. This checklist identifies rating categories for basic eligibility, FCW engineering, general items for all FCW, levees, concrete floodwalls, interior drainage system, pump stations, earthen (or excavated) flood-control channels, and concrete line flood-control channels. Each of the items is rated as being acceptable, marginally satisfactory, and unsatisfactory. Under the levees checklist, rated items include sod cover, unwanted vegetation growth, depressions/rutting, erosion/bank caving, slope stability, cracking, animal control, encroachments, riprap revetments and banks, closure structures, and underseepage relief wells/toe drainage systems (Table 4-1). Again, depending on the spatial and temporal resolutions of the imagery involved, remote sensing methods afford an efficient inspection method and assessment process for the majority of these items prior to conducting visual inspection. The levee owner's manual provides photographic examples of acceptable and unacceptable conditions for many of the items being rated, which are helpful guides for identifying similar conditions in remote imagery. Inspection by remote sensing methods does not replace the visual inspection process used for FCW but rather improves upon the inspection process. Remote sensing methods permit targeted visual inspection of areas of concern, especially those displaying anomalous signatures or problems observed from imagery.

The list of evaluation parameters in the levee owner's manual (USACE 2006b), which are used in the USACE levee screening tool (USACE 2011a), is presented in Table 4-1. Many of the items ranked can be efficiently evaluated by current (i.e., preferably less than 2 years old) high-resolution imagery, LiDAR data, and results of the periodic visual inspection survey. Ideally, this assessment and ranking process would extend even further and subdivide the system into different rating zones based on their condition at the time of the inspection/survey and other specific factors related to levee geometry (width of crest, levee slope, vegetation-free zone), construction history, age, foundation geology (i.e., geomorphology, depositional environment, blanket thickness), soils (i.e., USCS texture, shrink-swell potential), performance history during flooding, condition of maintenance, width of the buffer zone, and other factors that can impact levee safety.

Table 4-1. Levee embankments: For use during initial and continuing eligibility inspections of levee segments/systems.

Rated Item	Rating	Rating Guidelines	Monitoring Remarks/Recommendations
1. Unwanted Vegetation Growth	A	The levee has little or no unwanted vegetation (trees, bush, or undesirable weeds), except for vegetation that is properly contained and/or situated on overbuilt sections, such that the mandatory 3-ft root-free zone is preserved around the levee profile. The levee has been recently mowed. The vegetation-free zone extends 15 ft from both the landside and riverside toes of the levee to the centerline of the tree. If the levee access easement doesn't extend to the described limits, then the vegetation-free zone must be maintained to the easement limits. Reference EM 1110-2-301 or Corps policy for regional vegetation variance.	Current (< 1 year old) medium to high resolution visible and color infrared imagery (and aerial photography). LiDAR data. Visual inspection.
	M	Minimal vegetation growth (brush, weeds, or trees 2 in. in diameter or smaller) is present within the zones described above. This vegetation must be removed but does not currently threaten the operation or integrity of the levee.	
	U	Significant vegetation growth (brush, weeds, or any trees greater than 2 in. in diameter) is present within the zones described above and must be removed to reestablish or ascertain levee integrity.	
2. Sod Cover	A	There is good coverage of sod over the levee.	Current (< 1 year old) medium to high resolution visible and color infrared imagery (and aerial photography). Visual inspection.
	M	Approximately 25% of the sod cover is missing or damaged over a significant portion or over significant portions of the levee embankment. This may be the result of over-grazing or feeding on the levee, unauthorized vehicular traffic, chemical or insect problems, or burning during inappropriate seasons.	
	U	Over 50% of the sod cover is missing or damaged over a significant portion or portions of the levee embankment.	
	N/A	Surface protection is provided by other means.	
3. Encroachments	A	No trash, debris, unauthorized farming activity, structures, excavations, or other obstructions present, within the easement area. Encroachments have been previously reviewed by the Corps, and it was determined that they do not diminish proper functioning of the levee.	Current (< 1 year old) medium to high resolution imagery (and aerial photography). LiDAR and InSAR data. Visual inspection. Note change in utilities, urban development, transportation routes, and levee crossings.
	M	Trash, debris, unauthorized farming activity, structures, excavations, or other obstructions present or inappropriate activities noted that should be corrected but will not inhibit operations and maintenance or emergency operations. Encroachments have not been reviewed by the Corps.	
	U	Unauthorized encroachments or inappropriate activities noted are likely to inhibit operations and maintenance, emergency operations, or negatively impact the integrity of the levee.	
4. Closure Structures (Stop Log, Earthen Closures, Gates, or Sandbag Closures) (A or U only)	A	Closure structure in good repair. Placing equipment, stoplogs, and other materials are readily available at all times. Components are clearly marked and installation instructions/procedures readily available. Trial erections have been accomplished in accordance with the O&M Manual.	Visual inspection. Current (< 1 year old) high resolution imagery (and aerial photography).

Rated Item	Rating	Rating Guidelines	Monitoring Remarks/Recommendations
		<p>U Any of the following issues is cause for this rating: Closure structure in poor condition. Parts missing or corroded. Placing equipment may not be available within the anticipated warning time. The storage vaults cannot be opened during the time of inspection. Components of closure are not clearly marked and installation instructions/procedures are not readily available. Trial erections have not been accomplished in accordance with the O&M Manual.</p> <p>N/A There are no closure structures along this component of the FDR segment / system.</p>	
5. Slope Stability		<p>A No slides, sloughs, tension cracking, slope depressions, or bulges are present.</p> <p>M Minor slope stability problems that do not pose an immediate threat to the levee embankment.</p> <p>U Major slope stability problems (ex. deep seated sliding) identified that must be repaired to reestablish the integrity of the levee embankment.</p>	<p>Current (< 1 year old) high resolution imagery (and aerial photography).</p> <p>LiDAR and InSAR data.</p> <p>Visual inspection.</p> <p>USDA county soil survey bulletins maps and bedrock geology map of expansive soils (USGS Miscellaneous Investigations Series Map I-1940).</p> <p>Instrumentation at selected problem locations.</p>
6. Erosion/ Bank Caving		<p>A No erosion or bank caving is observed on the landward or riverward sides of the levee that might endanger its stability.</p> <p>M There are areas where minor erosion is occurring or has occurred on or near the levee embankment, but levee integrity is not threatened.</p> <p>U Erosion or caving is occurring or has occurred that threatens the stability and integrity of the levee. The erosion or caving has progressed into the levee section or into the extended footprint of the levee foundation and has compromised the levee foundation stability.</p>	<p>Current (< 1 year old) high resolution imagery (and aerial photography) for signs of slumping, scouring, trees leaning, and scallop bankline, especially in areas with no buffer zone.</p> <p>LiDAR and InSAR data of upper bank.</p> <p>Bathymetric and hydrographic surveys in the channel.</p> <p>Visual inspection.</p> <p>Instrumentation at selected problem locations.</p>
7. Settlement ²		<p>A No observed depressions in crown. Records exist and indicate no unexplained historical changes.</p> <p>M Minor irregularities that do not threaten integrity of levee. Records are incomplete or inclusive.</p>	<p>LiDAR and InSAR data.</p> <p>Current (< 1 year old) high resolution imagery (and aerial photography), note presence of standing water in low spots on</p>

Rated Item	Rating	Rating Guidelines	Monitoring Remarks/Recommendations
		U Obvious variations in elevation over significant reaches. No records exist or records indicate that design elevation is compromised.	levee crown. Visual inspection. Instrumentation at selected problem locations; deltaic environments are especially prone to subsidence and settlement issues. New levees and soft ground need close monitoring.
8. Depressions/ Rutting	A	There are scattered, shallow ruts, pot holes, or other depressions on the levee that are unrelated to levee settlement. The levee crown, embankments, and access road crowns are well established and drain properly without any ponded water.	LiDAR and InSAR data. Current (< 1 year old) high resolution imagery (and aerial photography), standing water in low spots on levee crown, signs of animal grazing and rutting of levee slopes by animal paths. Visual inspection.
	M	There are some infrequent minor depressions less than 6 in. deep in the levee crown, embankment, or access roads that will pond water.	
	U	There are depressions greater than 6 in. deep that will pond water.	
9. Cracking	A	Minor longitudinal, transverse, or desiccation cracks with no vertical movement along the crack. No cracks extend continuously through the levee crest.	Visual inspection. InSAR and LiDAR data. Problematic in semiarid areas with clay embankments where rainfall not evenly distributed, drought conditions occur, and expansive soils exist. Remote inspection is difficult. Very high resolution imagery required to detect by remote sensing methods, presence of sod/vegetation and slope of embankments are important.
	M	Longitudinal and/or transverse cracks up to 6 in. in depth with no vertical movement along the crack. No cracks extend continuously through the levee crest. Longitudinal cracks are no longer than the height of the levee.	
	U	Cracks exceed 6 in. in depth. Longitudinal cracks are longer than the height of the levee and/or exhibit vertical movement along the crack. Transverse cracks extend through the entire levee width.	
10. Animal Control	A	Continuous animal burrow control program in place that includes the elimination of active burrowing and the filling in of existing burrows.	Visual inspection. Especially problematic near nut orchards; high resolution imagery can target agricultural lands favorable for presence of burrowing animals. Remote inspection is difficult for this item unless very high resolution imagery can discriminate animal burrows.
	M	The existing animal burrow control program needs to be improved. Several burrows are present which may lead to seepage or slope stability problems, and they require immediate attention.	
	U	Animal burrow control program is not effective or is nonexistent. Significant maintenance is required to fill existing burrows, and the levee will not provide reliable flood protection until this maintenance is complete.	

Rated Item	Rating	Rating Guidelines	Monitoring Remarks/Recommendations
11. Culverts/ Discharge Pipes ³ (This item includes both concrete and corrugated metal pipes.)	A	There are no breaks, holes, cracks in the discharge pipes/ culverts that would result in significant water leakage. The pipe shape is still essentially circular. All joints appear to be closed and the soil tight. Corrugated metal pipes, if present, are in good condition with 100% of the original coating still in place (either asphalt or galvanizing) or have been relined with appropriate material, which is still in good condition. Condition of pipes has been verified using television camera videotaping or visual inspection methods within the past five years, and the report for every pipe is available for review by the inspector.	Visual inspection of their condition. Current (< 1 year old) and historic high resolution imagery (and aerial photography) to locate structures. LiDAR data to identify control structures on levee and side slopes. Determination of condition requires visual inspection.
	M	There are a small number of corrosion pinholes or cracks that could leak water and need to be repaired, but the entire length of pipe is still structurally sound and is not in danger of collapsing. Pipe shape may be ovalized in some locations but does not appear to be approaching a curvature reversal. A limited number of joints may have opened and soil loss may be beginning. Any open joints should be repaired prior to the next inspection. Corrugated metal pipes, if present, may be showing corrosion and pinholes but there are no areas with total section loss. Condition of pipes has been verified using television camera videotaping or visual inspection methods within the past five years, and the report for every pipe is available for review by the inspector.	Corrosive soils, ground water, and borrow pit sources can help with corrosion assessment. Handheld inspection devices and robotic systems (cameras, thermal imagers), concrete and water stop condition.
	U	Culvert has deterioration and/or has significant leakage; it is in danger of collapsing or as already begun to collapse. Corrugated metal pipes have suffered 100% section loss in the invert. HOWEVER: Even if pipes appear to be in good condition, as judged by an external visual inspection, an Unacceptable Rating will be assigned if the condition of pipes has not been verified using television camera videotaping or visual inspection methods within the past five years, and reports for all pipes are not available for review by the inspector.	
	N/A	There are no discharge pipes/ culverts.	
12. Riprap Revetments & Bank Protection	A	No riprap displacement or stone degradation that could pose an immediate threat to the integrity of channel bank. Riprap intact with no woody vegetation present.	Current (< 1 year old) high resolution imagery (and aerial photography) for signs of slumping, scouring, trees leaning, and scallop bankline, especially in areas with no buffer zone.
	M	Minor riprap displacement or stone degradation that could pose an immediate threat to the integrity of the channel bank. Unwanted vegetation must be cleared or sprayed with an appropriate herbicide.	LiDAR and InSAR data of upper bank.
	U	Significant riprap displacement, exposure of bedding, or stone degradation observed. Scour activity is undercutting banks, eroding embankments, or impairing channel flows by causing turbulence or shoaling. Rock protection is hidden by dense brush, trees, or grasses.	Bathymetric and hydrographic surveys in the channel. Visual inspection.
	N/A	There is no riprap protecting this feature of the segment/system, or riprap is discussed in another section.	Instrumentation at selected problem locations and historic map and photography studies of bank migration.

Rated Item	Rating	Rating Guidelines	Monitoring Remarks/Recommendations
13. Revetments other than Riprap	A	Existing revetment protection is properly maintained, undamaged, and clearly visible.	<p>Current (< 1 year old) high resolution imagery (and aerial photography) for signs of slumping, scouring, trees leaning, and scallop bankline, especially in areas with no buffer zone. Narrowing of river channel with deepening important sign of instability.</p> <p>LiDAR and InSAR data from upper bank.</p> <p>Bathymetric and hydrographic surveys from in the channel, monitoring of stability control line is important indicator. Visual inspection of upper bank for presence and signs of erosion.</p> <p>Instrumentation at selected problem locations for early warning. Tagging of bank protection with survey and geophysical monitoring capabilities.</p> <p>Historic map and photography studies of bank migration potential are important indicators</p> <p>Geophysical surveys of rebar in revetment.</p>
	M	Minor revetment displacement or deterioration that does not pose an immediate threat to the integrity of the levee. Unwanted vegetation must be cleared or sprayed with an appropriate herbicide.	
	U	Significant revetment displacement, deterioration, or exposure of bedding observed. Scour activity is undercutting banks, eroding embankments, or impairing channel flows by causing turbulence or shoaling. Revetment protection is hidden by dense brush and trees.	
	N/A	There are no such revetments protecting this feature of the segment / system.	
14. Underseepage Relief Wells/ Toe Drainage Systems	A	Toe drainage systems and pressure relief wells necessary for maintaining FDR segment/system stability during high water functioned properly during the last flood event and no sediment is observed in horizontal system (if applicable). Nothing is observed which would indicate that the drainage systems won't function properly during the next flood, and maintenance records indicate regular cleaning. Wells have been pumped tested within the past 5 years and documentation is provided.	<p>Geologic study of fluvial and deltaic depositional environments to identify those landforms prone to seepage issues – point bar, buried beaches, crevasse slays, abandoned channels and courses. Meandering river systems are especially prone to underseepage as they develop a fine-grained top stratum (blanket) and substratum (pervious aquifer).</p> <p>Visual inspection.</p> <p>High resolution imagery and historic aerial photography for identifying floodplain landforms, wet spots behind levees, and</p>
	M	Toe drainage systems or pressure relief wells are damaged and may become clogged if they are not repaired. Maintenance records are incomplete or indicate irregular cleaning and pump testing.	
	U	Toe drainage systems or pressure relief wells necessary for maintaining FDR segment/system stability during flood events have fallen into disrepair or have become clogged. No maintenance records. No documentation of the required pump testing.	

Rated Item	Rating	Rating Guidelines	Monitoring Remarks/Recommendations
		<p>N/A There are no relief wells/ toe drainage systems along this component of the FDR segment/system.</p>	<p>presence of seepage blankets and berms.</p> <p>Drainage ditches at levee toe are especially problematic, especially where dense woody vegetation occurs in ditch.</p> <p>Performance history from past flood events.</p> <p>Boring programs for engineering properties and determining blanket thickness.</p> <p>Instrumentation (piezometers, relief wells, river gages).</p> <p>Geophysical surveys to determine blanket thickness and identify/monitor seepage pathways by noninvasive methods.</p>
<p>15. Seepage</p>	<p>«LER15»</p>	<p>A No evidence or history of unrepaired seepage, saturated areas, or boils.</p>	<p>Geologic study of fluvial and deltaic depositional environments to identify those prone to seepage issues – point bar, buried beaches, crevasse slays, abandoned channels and courses. Meandering river systems are especially prone to underseepage as they develop a top stratum (blanket) and substratum (pervious aquifer). High resolution imagery and historic aerial photography for identifying floodplain landforms, wet spots behind levees, and presence of seepage blankets and berms.</p> <p>High resolution thermal imagery during flood events to determine temp variations that locate boil openings.</p> <p>Drainage ditches at levee toe are especially problematic, especially where dense woody vegetation occurs that can penetrate the blanket.</p> <p>Performance history from past flood events.</p> <p>Boring programs for engineering properties, blanket thickness.</p> <p>Geophysical surveys to determine blanket thickness and identify/monitor seepage pathways</p>
		<p>M Evidence or history of minor unrepaired seepage or small saturated areas at or beyond the landside toe but not on the landward slope of levee. No evidence of soil transport.</p>	
		<p>U Evidence or history of active seepage, extensive saturated areas, or boils.</p>	

USACE (2006a) guidelines in the levee owner's manual for non-federal FCW have been adopted as the standard for all USACE districts in the LMV by which projects will be maintained, inspected and evaluated for compliance (USACE 2006b). As an example, Vicksburg District Regulation DR 1130-2-530 (17 December 2006) uses this manual for its standard and provides additional requirements beyond those identified in the owner's manual and checklist in Appendix C (USACE 2006a). Enforcement of these requirements can be improved by incorporating remote sensing methods into the monitoring process as part of the periodic inspection program. The goal is to better identify specific locations where deficiencies may occur to permit targeted risk assessment using the levee screening tool method (USACE 2011a). A risk assessment is a measure of the probability and severity of undesirable consequences (HQUSACE 2010).

Tables 4-1 and 4-2 provide some general guidance for inspection and monitoring of embankments and floodwalls using remote-sensing techniques and monitoring through geophysical methods and instrumentation at problem areas. Remote inspection and monitoring is not intended to replace the traditional visual inspection process but rather permit a more efficient inspection process and better target problem areas. The concept of image resolution in Tables 4-1 and 4-2 is general in nature and described as being low (> 5 m), medium (1 to 5 m) and high (< 1 m) and denotes the pixel resolution of the imagery needed for inspection purposes (see Figures 2-4 and 2-5). A host of factors is involved in being able to discriminate specific targets, including the type of sensor and platform in use (space, airborne, or ground-based), season of the year when imagery was acquired (leaf-on versus leaf-off), age of the imagery, spectral bands and number used, and the scale of the river or levee system being evaluated as examples of the different variables at play. Reference is made to Tables 2-1 and 2-2, which provide characteristics of common satellite systems, including image resolution, sampling rate, and their spectral bands.

In general, high spatial and temporal resolution imagery are needed to conduct inspection of the structural components of the flood-control system, while medium resolution data are primarily needed for regional assessments of hazard and conducting general studies of the geology, land-use, and vegetation assessments.

Table 4-2. Floodwalls: For use during initial and continuing eligibility inspections of all floodwalls.

Rated Item	Rating	Rating Guidelines	Location/Remarks/Recommendations
1. Unwanted Vegetation Growth ¹	«Test»	A A grass-only or paved zone is maintained on both sides of the floodwall, free of all trees, brush, and undesirable weeds. The vegetation-free zone extends 15 ft from both the land and riverside of the floodwall, at ground-level, to the centerline of the tree. Additionally, an 8-ft root-free zone is maintained around the entire structure, including the floodwall toe, heel, and any toe-drains. If the floodwall access easement doesn't extend to the described limits, then the vegetation-free zone must be maintained to the easement limits. Reference EM 1110-2-301 and/or Corps policy for regional vegetation variance.	Current (< 1 year old) medium to high resolution visible and color infrared imagery (and aerial photography). LiDAR data. Visual inspection.
		M Minimal vegetation growth (brush, weeds, or trees 2 in. in diameter or smaller) is present within the zones described above. This vegetation must be removed but does not currently threaten the operation or integrity of the floodwall.	
		U Significant vegetation growth (brush, weeds, or any trees greater than 2 in. in diameter) is present within the zones described above. This vegetation threatens the operation or integrity of the floodwall and must be removed.	
2. Encroachments	«FWR2»	A No trash, debris, unauthorized structures, excavations, or other obstructions present within the easement area. Encroachments have been previously reviewed by the Corps, and it was determined that they do not diminish proper functioning of the floodwall.	Current (< 1 year old) medium to high resolution imagery (and aerial photography). LiDAR and InSAR data. Visual inspection. Note change in utilities, urban development, transportation routes, and levee crossings.
		M Trash, debris, unauthorized structures, excavations, or other obstructions present, or inappropriate activities noted that should be corrected but will not inhibit operations and maintenance or emergency operations. Encroachments have not been reviewed by the Corps.	
		U Unauthorized encroachments or inappropriate activities noted are likely to inhibit operations and maintenance, emergency operations, or negatively impact the integrity of the floodwall.	
3. Closure Structures (Stop Log Closures and Gates) (A or U only)		A Closure structure in good repair. Placing equipment, stoplogs, and other materials are readily available at all times. Components are clearly marked and installation instructions/ procedures readily available. Trial erections have been accomplished in accordance with the O&M Manual.	Visual inspection. Instrumentation - remote monitoring with cameras and sensors Current (< 1 year old) medium to high resolution visible and color infrared imagery (and aerial photography) to locate features for inspection.
		U Any of the following issues is cause for this rating: Closure structure in poor condition. Parts missing or corroded. Placing equipment may not be available within the anticipated warning time. The storage vaults cannot be opened during the time of inspection. Components of closure are not clearly marked and installation instructions/procedures are not readily available. Trial erections have not been accomplished in accordance with the O&M Manual.	
		N/A There are no closure structures along this component of the FDR segment/ system.	
4. Concrete Surfaces		A Negligible spalling, scaling or cracking. If the concrete surface is weathered or holds moisture, it is still satisfactory but should be seal coated to prevent freeze/ thaw damage.	Visual inspection.

Rated Item	Rating	Rating Guidelines	Location/Remarks/Recommendations
		<p>M Spalling, scaling, and open cracking present, but the immediate integrity or performance of the structure is not threatened. Reinforcing steel may be exposed. Repairs/sealing is necessary to prevent additional damage during periods of thawing and freezing.</p> <p>U Surface deterioration or deep cracks present that may result in an unreliable structure. Any surface deterioration that exposes the sheet piling or lies adjacent to monolith joints may indicate underlying reinforcement corrosion and is unacceptable.</p>	
5. Tilting, Sliding or Settlement of Concrete Structures ²	«FWR5»	<p>A There are no significant areas of tilting, sliding, or settlement that would endanger the integrity of the structure.</p> <p>M There are areas of tilting, sliding, or settlement (either active or inactive) that need to be repaired. The maximum offset, either laterally or vertically, does not exceed 2 in. unless the movement can be shown to be no longer actively occurring. The integrity of the structure is not in danger.</p> <p>U There are areas of tilting, sliding, or settlement (either active or inactive) that threaten the structure's integrity and performance. Any movement that has resulted in failure of the waterstop (possibly identified by daylight visible through the joint) is unacceptable. Differential movement of greater than 2 in. between any two adjacent monoliths, either laterally or vertically, is unacceptable unless it can be shown that the movement is no longer active. Also, if the floodwall is of I-wall construction, then any visible or measurable tilting of the wall toward the protected side that has created an open horizontal crack on the riverside base of a monolith is unacceptable.</p>	<p>Visual inspection.</p> <p>Instrumentation - remote monitoring with cameras, tiltmeters, settlement gages, and other sensors</p> <p>Current (< 1 year old) very high resolution visible and color infrared imagery (and aerial photography) to locate features for inspection. Alignment of panels may be possible with very high resolution imagery provided width of walls is detectable with multiple pixels.</p>
6. Foundation of Concrete Structures ¹		<p>A No active erosion, scouring, or bank caving that might endanger the structure's stability.</p> <p>M There are areas where the ground is eroding towards the base of the structure. Efforts need to be taken to slow and repair this erosion, but it is not judged to be close enough to the structure or to be progressing rapidly enough to affect structural stability before the next inspection. For the purposes of inspection, the erosion or scour is not closer to the riverside face of the wall than twice the floodwall's underground base width if the wall is of L-wall or T-wall construction; or if the wall is of sheetpile or I-wall construction, the erosion is not closer than twice the wall's visible height. Additionally, rate of erosion is such that the wall is expected to remain stable until the next inspection.</p> <p>U Erosion or bank caving observed that is closer to the wall than the limits described above, or is outside these limits but may lead to structural instabilities before the next inspection. Additionally, if the floodwall is of I-wall or sheetpile construction, the foundation is unacceptable if any turf, soil or pavement material got washed away from the landside of the I-wall as the result of a previous overtopping event.</p>	<p>Visual inspection.</p> <p>Current (< 1 year old) very high resolution visible and color infrared imagery (and aerial photography) to identify presence of scouring, changes in vegetation.</p> <p>Instrumentation - remote monitoring with cameras, tiltmeters, settlement gages, and other sensors</p>
7. Monolith Joints		<p>A The joint material is in good condition. The exterior joint sealant is intact and cracking/desiccation is minimal. Joint filler material and/or waterstop are not visible at any point.</p>	<p>Visual inspection.</p>

Rated Item	Rating	Rating Guidelines	Location/Remarks/Recommendations
		M The joint material has appreciable deterioration to the point where joint filler material and/or waterstop is visible in some locations. This needs to be repaired or replaced to prevent spalling and cracking during freeze/thaw cycles, and to ensure water tightness of the joint.	Instrumentation - remote monitoring with cameras, tiltmeters, settlement gages, and other sensors
		U The joint material is severely deteriorated or the concrete adjacent to the monolith joints has spalled and cracked, damaging the waterstop; in either case damage has occurred to the point where it is apparent that the joint is no longer watertight and will not provide the intended level of protection during a flood.	Current (< 1 year old) very high resolution visible and color infrared imagery (and aerial photography) to identify wet spots, changes in vegetation, discoloration of structure.
		N/A There are no monolith joints in the floodwall.	
8. Underseepage Relief Wells/ Toe Drainage Systems		A Toe drainage systems and pressure relief wells necessary for maintaining FDR segment/system stability during high water functioned properly during the last flood event and no sediment is observed in horizontal system (if applicable). Nothing is observed which would indicate that the drainage systems won't function properly during the next flood, and maintenance records indicate regular cleaning. Wells have been pumped tested within the past 5 years and documentation is provided.	Visual inspection. Instrumentation – evaluate existing instrumentation and consider remote monitoring with automated weirs, foundation piezometers, pore pressure, settlement gages, and/or other sensors as required. Temperature sensors into wells and toe drains may be appropriate for developing temperature history and ground water knowledge. Remote inspection of toe drain systems should be performed as a component of the assessment process.
		M Toe drainage systems or pressure relief wells are damaged and may become clogged if they are not repaired. Maintenance records are incomplete or indicate irregular cleaning and pump testing.	
		U Toe drainage systems or pressure relief wells necessary for maintaining FDR segment/system stability during flood events have fallen into disrepair or have become clogged. No maintenance records. No documentation of the required pump testing.	Review borings and geologic study of foundation conditions to determine areas prone to seepage.
		N/A There are no relief wells/ toe drainage systems along this component of the FDR segment/system.	Current (< 1 year old) very high resolution visible and color infrared imagery (and aerial photography) to identify wet spots, presence of vegetation at toe drains, changes in nearby vegetation, discoloration of surface water.
9. Seepage		A No evidence or history of unrepaired seepage, saturated areas, or boils.	Visual inspection.
		M Evidence or history of minor unrepaired seepage or small saturated areas at or beyond the landside toe but not on the landward slope of levee. No evidence of soil transport.	Performance history of past flood events.
		U Evidence or history of active seepage, extensive saturated areas, or boils.	Review borings and geologic study of foundation conditions to determine areas prone to seepage. Current (< 1 year old) very high resolution visible and color infrared imagery (and aerial photography) to identify wet spots, changes of vegetation at toe drains, changes in nearby vegetation, discoloration of surface water.

4.4 Advances in technologies for FCW inspection and monitoring

4.4.1 Introduction

Recent advances in technology permit significant improvements in the levee inspection process by using remote sensing and monitoring methods as compared to the traditional visual inspection method. Four technologies are briefly described here to highlight examples of game changing improvements in inspection, monitoring, and/or research opportunities in failure mode analysis. These technologies involve the use of unmanned aerial vehicles (UAV), thermal cameras for detection of boils behind levees, communication of boil activity and poor performance using GPS-enabled cell phones, and high resolution LiDAR data for identifying sand boil locations behind levees.


4.4.2 UAV)

The use of remote UAVs for targeted inspections of FCW has great promise for examination of structural items and components in the inspection checklist in Table 4-2. Helicopter systems equipped with high resolution cameras can perform detailed inspections of structural wall alignments and other hard-to-inspect items due to height and access issues. The ability to remain stationary for close-up inspection is an attractive feature of unmanned rotary aircraft.

USACE Jacksonville District has been working with small, electric powered fixed-wing UAVs for several years (Campbell 2012) and has developed advanced capabilities to conduct remote inspection of their structures and levees (Figure 4-1). Acquisition of very high resolution georeferenced imagery provides an important tool to aid with inspection of levees. This capability is especially valuable for targeted flood fight applications requiring an aerial perspective and providing color and IR imagery capabilities. The ability to fly a thermal camera for inspection of seepage areas is particularly desirable. A thermal capability needs further development to become fully operational (Taylor 2012).

Figure 4-1. USACE Jacksonville District has been working with UAV technology for several years to create high resolution GPS image mosaics and for monitoring their structures and levee systems (USACE 2012c). Also see link at <http://www.saj.usace.army.mil/Missions/UnmannedAerialVehicle.aspx> for more information.

**US ARMY CORPS
OF ENGINEERS
JACKSONVILLE
DISTRICT**




NOVA News


Volume I, Issue I
Newsletter Date: November 30, 2012


NOVA Demonstrates Remote Construction Monitoring

In March of 2012 the NOVA team flew the Merritt Pump Station in the Picayune Strand Project. The enlargement shows the NOVA's ability to provide georectified mosaics and highly detailed information. In addition to the single coverage mission, the NOVA can provide "change over time data" which could show measurable images of a construction site from excavation through comple-



The image below is an enlargement of a small area outside the main pump station building. It shows the level of detail that can be achieved.



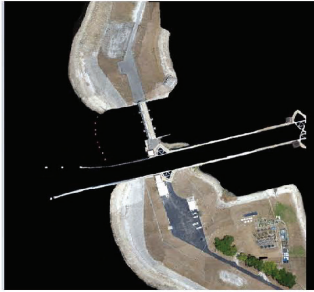


sUAS News (*small Unmanned Aerial Systems*)

<http://www.suasnews.com/>

Small UAS (sUAS) vehicles are being used around the globe for many purposes. While war fighting is still a dominant application, an increasing number of sUAS are being used for peaceful or scientific in purposes. The above link will take you to a web publication where many applications other than our NOVA program can be found.

(Image at the right is a NOVA mosaic of our St. Lucie lock)



The NOVA News is published by the Jacksonville District NOVA UAS team as a service to our customers and potential customers to keep them informed of happenings in the NOVA program as well as the wider sUAS industry

4.5 Thermal imagery and FLIR

The use of thermal imagery in detecting sand boils was demonstrated during the 2011 flood on the Mississippi River by the USACE Vicksburg District using a FLIR 8500 airborne imaging system mounted to an Arkansas State Police helicopter (Woerner 2012). Airborne inspection of the levee using the FLIR system identified a large sand boil at the edge of an oxbow behind the main-line levee system at Lake Chicot, AR, because of the ability to identify temperature variations in seepage (Figure 4-2). This sand boil was sand bagged to prevent movement (piping) of foundation material because of the high hydrostatic heads in the substratum aquifer caused by the flooding. Airborne inspection using helicopter and UAV capabilities permits focused inspection of seepage areas (Figure 4-3). The bird's eye perspective from these platforms adds another important dimension and capability to the inspection process during flooding.

4.6 Smart phone technology

During the 2011 flood on the Mississippi River, smart phone technology allowed rapid reporting and assessment of sand boil activity and problem areas from the field. The integration of GPS, camera, and compass capabilities with form reporting using Wi-Fi and telephone communication permitted a cost-effective method for capturing and transmitting flood fight data to decision-makers (USACE 2011a). The U.S. Army Engineer Research and Development Center's (ERDC's) Information Technology Laboratory (ITL) developed an Android-based application known as the Mobile Information Collection Application (MICA) to communicate flood fight information to command centers (Figure 4-4). Over 12,000 pictures, videos, and notes were transmitted using 50 cell phones furnished to flood inspection teams in the LMV flood area. The integration of GPS with field imagery permits coordinated decision-making in real-time and deployment of resources to "hot spot" areas (example area in Figure 4-2). These data can be overlaid on high resolution imagery and combined with GIS data to assess conditions in the field in real-time.

Numerous sand boils were located in the Leland Chute area during the 2011 Mississippi River Flood with the MICA Android capability north of Lake Chicot (Figure 4-5). A deep drainage ditch at the toe of the levee penetrated the thin point bar blanket, permitting numerous sand boils to develop. Interestingly, these boils in the drainage ditch are mainly concentrated along the point bar ridges, where shallow substratum sand was present. Many of these boils required sand bagging to prevent loss of foundation

Figure 4-2. FLIR 8500 thermal imaging system onboard Arkansas State Police helicopter used to detect sand boils at Lake Chicot from background seepage by colder temperature during 2011 flooding on the Mississippi River (Woerner 2012).

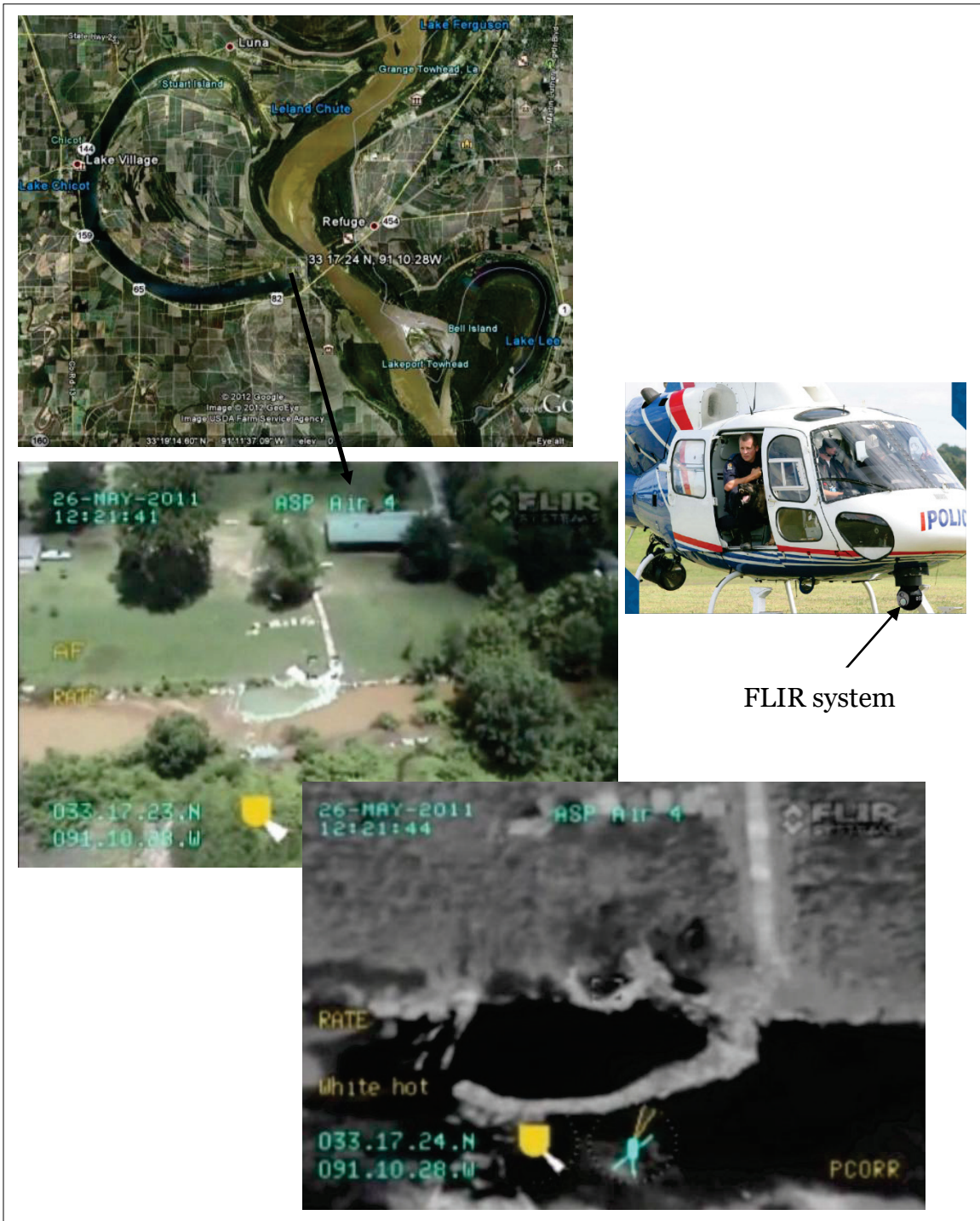


Figure 4-3. View looking southwest (downstream) during the May 2011 Mississippi River Flood north of Lake Chicot, AR (Eric Woerner, personal communication, Vicksburg District 2012). Light to moderate seepage (see Table 3-1) collecting in the low lying point bar swales. These swales developed as ends of Lake Chicot converged to form an abandoned channel or oxbow of the Mississippi River. The tree line at landside levee toe was site of numerous sand boils (see Figure 4-5 for view of the LiDAR data).

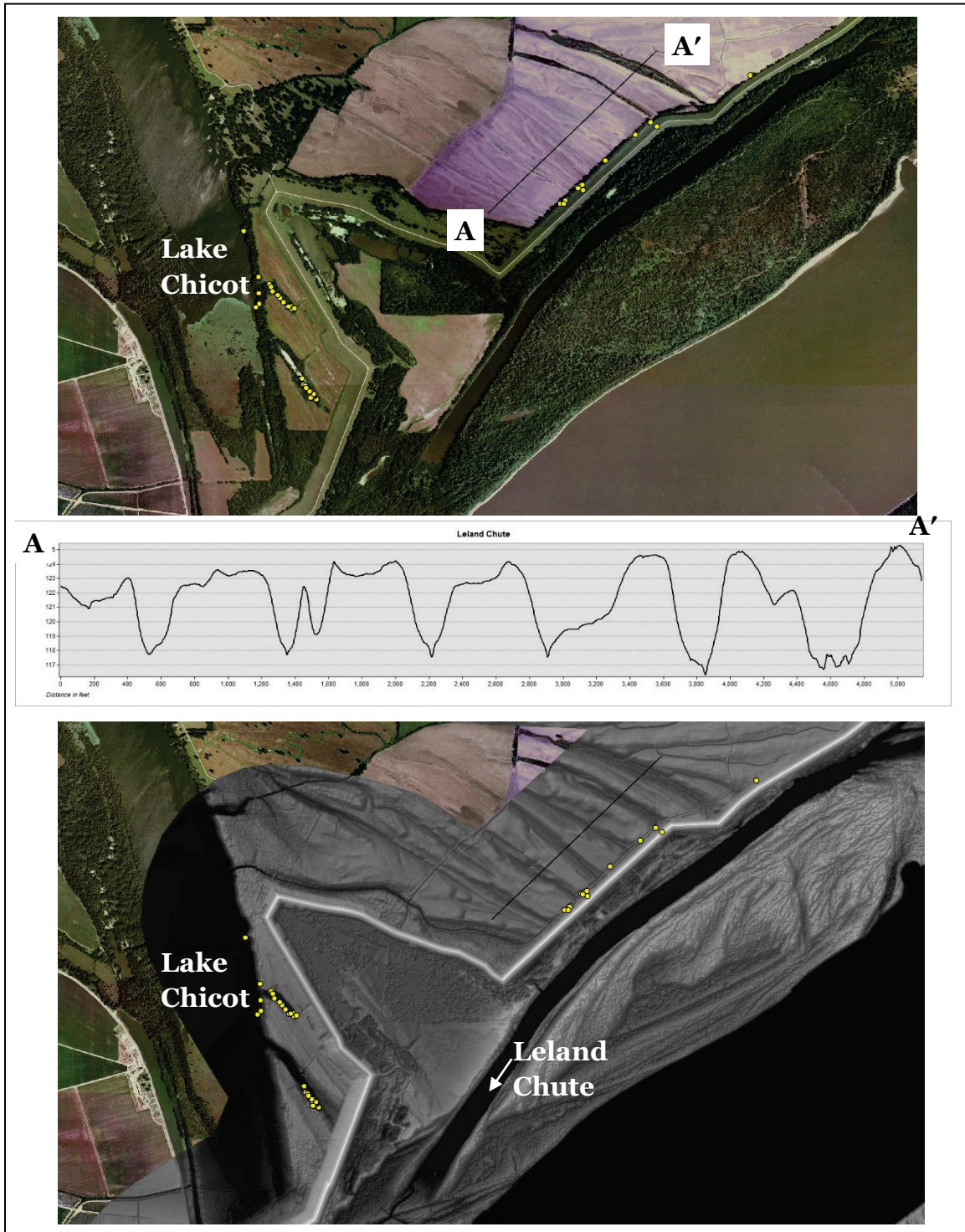
Google Image (2012) (right) showing the location of the seepage area (bottom photograph) north of Lake Chicot, Arkansas.



Figure 4-4. MICA Android phone application for reporting seepage incidents to command centers during the May 2011 Mississippi River Flood (USACE 2011b). Example problem area shown in Figure 4-3 and 4.5. The phone app permits communication of written information and integration of GPS imagery to decision-makers.



Figure 4-5. Color and hillshade LiDAR images from upstream of Lake Chicot at Leland Chute showing the point bar ridge and swale topography and relationship to sand boils (noted by yellow circles in images) during 2011 flood. The drainage ditch at the landside toe of the levee was a major problem for sand boil activity at the point bar ridges (sandy areas). Profile A-A' shows the elevation difference between the sandy ridges and low-lying swales. Same areas depicted in Figure 4-3.



material. Also, a major concentration of boils occurred in two deep swales (adjacent to Lake Chicot label in Figure 4-5) that intersected the upstream arm of Lake Chicot. These deeper swales are still connected to the underlying aquifer sand. The presence of the levee has prevented these swales from becoming filled with fine-grained sediment by the annual flooding cycle. LiDAR data permit definition of subtle topographic features and provide another important assessment tool for understanding and prediction of poor performance in levee systems related to underseepage.

4.7 Flood Risk Management Research Consortium (FRMRC), United Kingdom (UK)

Another perspective of remote sensing involving FCW is summarized from work in the United Kingdom (UK). The FRMRC (www.floodrisk.org) in the UK is currently reviewing remote sensing and monitoring technologies and strategies for assessing their flood defense systems (FRMRC 2012). FRMRC has divided flood protection defense into a system, reach and subreach, and asset level classification hierarchy. Inspection strategies for these three different levels are presented from Table 4-3 to Table 4-5 for system, failure mode, and asset level assessments, respectively (FRMRC 2012).

General benefits and limitations of technologies for performing system-wide inspection are presented in Table 4-3. Asset level monitoring in Table 4-4 involves failure mode assessment and examination of the different inspection parameters. Last, the detailed level inspection process requires a high fidelity of data (Table 4-5). Handheld systems are included in this category, such as portable X-ray imaging units for some structural and mechanical components of the flood protection system. This type of targeted approach evaluates the flood protection defenses in both the wet and dry states to ensure system reliability. Future research by the FRMRC researchers in remote sensing and monitoring will involve case histories using these technologies at problem reaches. Their approach provides another perspective for using remote monitoring at the international level. This approach, along with the parameters identified in Table 4-3 to Table 4-5, is similar to USACE inspection items in Table 4-1 and Table 4-2 that qualify FCW for federal eligibility in PL-84-99.

Table 4-3. System level surveys using remote data in the UK for flood defense systems (FRMRC 2012).

Technology	Coverage	Accuracy	£/km ²	Benefits	Limitations
Aerial Photography/ Photogrammetry (top-down)	System->Sub-reach depending on altitude	H _z = XXm V _t = N/A	Medium	<ul style="list-style-type: none"> Highly accurate in assessing x and y dimensions of assets High resolution images of assets systems can be easily acquired Can be used in conjunction with LIDAR to create a highly accurate 3-D model of asset system 	<ul style="list-style-type: none"> Low accuracy in the z dimension Limited view of asset slopes or faces Effected by cloud cover Environmental conditions limit use frequently Does not produce a true crest/asset profile where there are trees, buildings or other obstructions
Oblique Aerial Photography (bird's eye)	Reach->Sub-reach	H _z = XXm V _t = N/A	High	<ul style="list-style-type: none"> Only method capable of examining underwater features Highly accurate in terms of the requirements of the project 	<ul style="list-style-type: none"> Crest elevation difficult to accurately assess Camera angle obscures view of some features Multiple shots required for all sides of assets Cost to cover a large area such as an asset system
Satellite photography	System		Low	<ul style="list-style-type: none"> Can produce high quality images of whole asset systems Can be used to initiate analysis and determine areas for further investigation Number of satellites already in place and acquiring such images as a matter of course 	<ul style="list-style-type: none"> Not very useful in identifying problems at the asset level Cannot produce images under cloud cover View of assets obscured by vegetation cover
Aerial Near IR Photography	System->Sub-reach depending on altitude	As previous results shown depending upon system being used	Medium	<ul style="list-style-type: none"> Detects extent of vegetation more clearly than standard photography Potential for identification of type and state of vegetative features Potential for highlighting areas of greater and lesser moisture content 	<ul style="list-style-type: none"> Less useful than standard photography in identifying non vegetative features Only truly useful in combination with standard photography and/or other methods such as LIDAR
Airborne LIDAR (standard)	System->Reach	X = 0.02- 0.3 m Y = 0.02-0.3 m Z = 0.1-0.6 m	High	<ul style="list-style-type: none"> Most accurate system level method for assessing height elevation Can produce an estimation of both ground surface and surface feature elevation such as vegetation Much less labor and time intensive than traditional ground-based surveying of assets 	<ul style="list-style-type: none"> Less accurate than photography in x and y dimensions Requires a large number of overlapping flight paths to be run Requires extensive data processing to provide useful data Does not show non-positional damage or deterioration Signal is affected by vegetation requiring software filtering process to eliminate ground features
Airborne LIDAR (high density e.g., Fli-Map)	System->Reach	X = 0.08->0.20 Y = 0.08->0.20 Z = 0.05->0.15	High	<ul style="list-style-type: none"> Even higher accuracy and resolution than standard LIDAR Can identify thin features such as walls that may not be identified under standard LIDAR 	<ul style="list-style-type: none"> Less coverage than standard LIDAR thus increasing cost and time for surveying

Technology	Coverage	Accuracy	£/km ²	Benefits	Limitations
Ground-based LIDAR	Reach->Sub-reach	X = 0.03->0.06 Y = 0.03->0.06 Z = 0.03->0.06	Medium ->High	<ul style="list-style-type: none"> Provides greatest accuracy and resolution Can view assets from angles that are obscured from an aerial survey or under heavy vegetative cover Potential for detailed assessment of inner faces of assets by boat 	<ul style="list-style-type: none"> Time consuming and expensive Required vehicular access to assets that may prove problematic in many instances
Satellite InSAR	System	X = 5-10 m Y = 5-10 m Z = 0.7-1 m	Low	<ul style="list-style-type: none"> Not affected by cloud cover Can produce images 24 hr a day Systems already in place and use for DEM modeling and other applications Longer wavelength-based systems (e.g., p-band) can overcome or reduce problems with scattering caused by vegetation 	<ul style="list-style-type: none"> Signal is scattered by vegetation cover, a significant issue in terms of rural flood defences Low accuracy in comparison to other system level methods Longer wavelength systems more greatly affected by Faraday Rotation which reduces system accuracy and viability
Airborne InSAR	System-Reach		Medium ->Low	<ul style="list-style-type: none"> Higher resolution and accuracy over satellite-based system Not affected by cloud cover therefore can be used at high higher altitudes Can be flown 24 hr/day Longer wavelength methods not affected by Faraday Rotation 	<ul style="list-style-type: none"> Still adversely affected by vegetation coverage Longer wavelength systems require regulatory approval for use Still not as accurate as other airborne systems
Ground-based InSAR	Reach->Sub-reach		Medium ->High	<ul style="list-style-type: none"> Higher resolution and accuracy over satellite and airborne-based systems Can be used at night-time avoiding disruption and traffic issues Longer wavelength methods not affected by Faraday Rotation or regulatory approval issues 	<ul style="list-style-type: none"> Access to assets by vehicle could be difficult in many instances Repeated scans needed to get accurate data Vehicle's relative position to asset line must be highly consistent on each and every scan path

Technology	Coverage	Accuracy	£/km ²	Benefits	Limitations
Side Scan Sonar	Reach->Sub-reach	Very high	Low	<ul style="list-style-type: none"> • Only method capable of examining underwater features • Highly accurate in terms of the requirements of the project • Relatively inexpensive equipment in comparison to other system level techniques • Could utilize existing use by EA for fisheries management or channel assessment with little or no adaptation 	<ul style="list-style-type: none"> • Can only produce an assessment of features below water line • Expensive in comparison to visual inspection of structures at low water (if possible) • Output may be affected by underwater debris • Shallow water channels may be unsuitable for this type of survey • Bathymetric surveys
GPS Network	System	0.05-5 m	Low	<ul style="list-style-type: none"> • Can produce continuous system level monitoring for detecting structural movement • Very cheap to process and maintain once initial setup of GPS network in place • May be able to use existing UK GPS network 	<ul style="list-style-type: none"> • Highly accurate in terms of the requirements of the project

Table 4-4. Failure mode assessments using remote data in the UK for flood defense systems (FRMRC 2012).

Asset Type	Failure Mode	Frequency ^a	Performance Parameters	Visual Indicators	Remote Data
Embankments	Overtopping	High	Crest height Outer slope grass quality Outer slope angle	Rutting of crest Crest height below SoP Vegetation on outer slope	Crest height profiles from LIDAR, Aerial Photogrammetry or InSAR GPS measurements IR Photogrammetry
	Slope instability	Medium	Crack width Slip distance Slope angle Slip width Slip height Slip circle radius	Cracking Slope movement Animal burrowing 3rd party damage to slope or toe	LIDAR (if severe movement)? IP camera data? Ground penetrating radar Tell tale InSAR

Asset Type	Failure Mode	Frequency ^a	Performance Parameters	Visual Indicators	Remote Data
	Piping	Low	Embankment width Soil coefficients Seepage length Water level difference Creep ratio	Signs of seepage Presence of washed out fines Animal burrowing Altered vegetation on bank?	IP camera data? Ground penetrating radar Tell tale IR Photogrammetry Soil analysis
Sheet pile wall	Tie/anchor failure	Medium	Ground level (inner) Ground level (outer) Tie/anchor angle Tie/anchor length	Missing anchor plates Loose anchor plates Cracking in ground behind wall	Hi-res LIDAR (if wall misalignment) Tell-tale or gage ggageageggageagegagegagegagegagegageStrain gage
	Rotational Slip/ Overturning	Medium	Ground level (inner) Ground level (outer) Distance between tie rods	Crest of wall alignment Slumping behind wall Anchor head sinking	Hi-res LIDAR (if wall misalignment) Tell-tale or gage Strain gage
	Backfill Washout	Low	???	Holes in sheet pile Gaps at clutches	Ultrasonic scanner Thermal imagery
	Rotation about tie	Medium	Ground level (inner) Ground level (outer) Toe level	Heave/slumping behind wall Misalignment of wall and crest Scour and movement at toe	Hi-res LIDAR (if wall misalignment) Tell-tale or gage Strain gage
Sheet pile/ gravity wall	Piping	Low	Seepage length (Hx&Vt) Creep ratio Water level Groundwater level	Signs of seepage Presence of washed out fines Holes in sheet pile	Near IR photography InSAR Thermal Imagery Ultrasonic Scanners
Gravity wall (masonry)	Horizontal sliding	Very low	Slide length Wall weight	Misalignment of wall sections Cracking/slump/heaving in ground behind wall	LIDAR Aerial photography Tell-tale or gage
	Rotational slip	Medium	Slab length Ground level (inner) Ground level (outer)	Scour at toe Misalignment of wall crest (clockwise/toward land) Heaving in ground behind wall Cracking in wall or ground behind wall	Oblique photography Accelerometer/gyroscope in wall Ground based LIDAR
	Overturning	Medium	Wall width Ground level (inner) Ground level (outer)	Misalignment of wall crest (anti-clockwise/toward channel) Slump in ground behind wall Cracking in wall or ground behind wall	Oblique photography Accelerometer/gyroscope in wall Ground based LIDAR

Asset Type	Failure Mode	Frequency ^a	Performance Parameters	Visual Indicators	Remote Data
	Bearing capacity	High	Slab length Ground level (inner) Ground level (outer)	Lowered wall sections Cracks in wall Cracking of ground behind wall Heave in front of toe	LIDAR Oblique photography Accelerometer/Tell-tale in wall Ground based LIDAR
	Backfill washout	Medium	???	Presence of washed out fines Holes in wall Signs of seepage	Thermography Strain gage Ultrasonic pulse
Revetment	Toe failure	High	Scour depth		
	Uplift sliding	Medium			
	Backfill washout	Low			

Table 4-5. Detailed inspection and remote monitoring of flood control assets (FRMRC 2012).

Method/Technology	Results	Limitations
Fixed point photography and potential failure (PF) measurement	<ul style="list-style-type: none"> Simple methods to implement Requires no expensive technology A <i>measured</i> step forward in formalizing the inspection regime and increasing consistency 	<ul style="list-style-type: none"> Labor intensive inspection method Training and technical knowledge on potential modes of failure will be likely to be required Still requires judgment of inspection staff in order to determine elements for measurement
Ground based laser survey equipment	<ul style="list-style-type: none"> Easy to use tool that does not require surveying experience Enables overlay of reference elevation to ease identification of crest profiles Provides accurate asset geometry without need for expensive topographical survey Records and logs data automatically for transfer into NFCDD 	<ul style="list-style-type: none"> Expensive technology to provide to all inspection staff Unknown if technology accurate enough to identify changes not visible through a standard inspection Access issues may limit its effective use for many assets Unsure if laser based technology is suitable for all structure types Staff will require training Accurate asset geometry may be useful but may not significantly improve performance assessment
Thermal imagery/thermography	<ul style="list-style-type: none"> Can be used to identify sub-surface problems in many materials, especially concrete and masonry Can be used to detect voids and/or signs of seepage not possible under a visual inspection Relatively easy to use in comparison with other NDT methods 	<ul style="list-style-type: none"> Does not detect deep sub-surface issues Accuracy affected by material properties such as thickness and moisture content Environmental conditions may adversely affect results Expensive

Method/Technology	Results	Limitations
		<ul style="list-style-type: none"> • Requires expertise in interpreting results • Only of greatest use for concrete structures
Ultrasonic scanning	<ul style="list-style-type: none"> • Can detect deep sub-surface flaws in structures • Can identify thickness of sheet pile • Can be used for detection of sub-surface honeycombing or cracks in concrete structures 	<ul style="list-style-type: none"> • Difficult to interpret results without training and experience • Expensive equipment • Little use with earth embankments (most common liner defence structure)
Ground penetrating radar	<ul style="list-style-type: none"> • Highly suited to examining sub-surface detail of structures • Have been shown to detect geotechnical issues that are undetectable by visual inspection • Can be useful on all asset types 	<ul style="list-style-type: none"> • Adversely affected with wet clayey soils (which are common in flood defences) • Generally uses bulky and expensive equipment unsuitable for use by inspection staff • Results require expert analysis
Radiometry/radiography	<ul style="list-style-type: none"> • Can detect sub-surface damage • Differences in material condition and thickness throughout a material that are not visible can be identified 	<ul style="list-style-type: none"> • Potential hazards of use (uses X-rays and gamma rays) require effective training • Only really suitable for wall type structures • Expensive and difficult to use in the field by inspection staff • Results require post processing before interpretation can be performed
Motion sensor (accelerometer)	<ul style="list-style-type: none"> • Can provide a profile of structural movement over time that is not possible through regular visual inspections • Relatively inexpensive and easy to install and calibrate • Can draw upon wide experience of use in dam and reservoir assessment 	<ul style="list-style-type: none"> • Accuracy of movement detection may be insufficient for purposes • Technology may be unsuitable for small flood defence structures • Used on its own it may not provide enough information on nature of problems
Inclinometer	<ul style="list-style-type: none"> • Can detect changes in angle and misalignment of structures that is not visible to the human eye • Relatively inexpensive to implement • Can be combined with other sensors (e.g., accelerometers, GPS, tell-tales) to produce a holistic view of structural change over time 	<ul style="list-style-type: none"> • Used on its own it may not provide enough information on nature of problems
Tell-tales and gages	<ul style="list-style-type: none"> • Simple methods to implement • Requires no expensive technology except for potential telemetry for continuous monitoring • Can be applied to specific areas of concern such as cracks or wall crests 	<ul style="list-style-type: none"> • Requires accurate installation on asset • Lack of accuracy depending on placement and type of gage • Without telemetry, which increases cost, it cannot provide continuous monitoring
GPS station	<ul style="list-style-type: none"> • Can detect position to a centimeter level of accuracy • Well understood technology that is already in use for structural health monitoring • Receivers have become much cheaper in recent years 	<ul style="list-style-type: none"> • Inherent inaccuracy of GPS may be unsuitable for detecting small changes in position • Requires a clear view of satellites • Problems in placing receiver(s) in ideal location for detecting change

Method/Technology	Results	Limitations
	<ul style="list-style-type: none"> • Can be used both at the asset or asset system level • Could be combined with other sensors to provide a holistic view of changes to asset 	<ul style="list-style-type: none"> • Used along it may not produce a good assessment of ongoing problems
Real-time reflectometry	<ul style="list-style-type: none"> • Can detect deep slope movements not possible under a purely visual inspection • Once installed should require little maintenance or calibration 	<ul style="list-style-type: none"> • Invasive testing method that requires cables to be installed ground surrounding/forming structure • May not produce required accuracy for smaller structures found in flood defence

5 Instrumentation and Monitoring

5.1 Introduction

The purpose of this chapter is to identify and review effective technologies related to the remote monitoring of earthen structures (dams and levees) during extreme loading events. Extreme loading events considered here are primarily flood loading and, to a lesser extent, seismic loading from extreme earthquake events. USACE guidance has been consistent on instrumentation requirements for the safety of its dams and is described in various engineering manuals (HQUSACE 1981, 1987, 1995a, 1995b, 2004, 2011c). Therefore, it is appropriate first to summarize the guiding principles involving instrumentation of USACE water control facilities (HQUSACE 2011).

“All USACE dams and other water control facilities are required to have a level of instrumentation that enables proper monitoring and evaluation of the structure during the construction period and under all operating conditions. Instrumentation systems are also expected to furnish data on structural behavior for application to future designs. Each dam or other water control structure shall have instrumentation to measure hydrostatic pressure, embankment and abutment seepage, foundation underseepage, and displacement of major elements of the structure. Additionally, strong motion accelerometers are to be installed in structures located in designated seismic regions in accordance with USACE (1981b).

After a project is operational for several years, scheduled maintenance, repair, and replacement of instrumentation shall be part of the normal plan of operation. Instrumentation shall be properly maintained or replaced, as necessary, in order to obtain accurate and timely data. Readings shall be made at scheduled frequency and shall be properly recorded and analyzed. Detailed information on instrumentation for earth and rock fill dams is given in HQUSACE (2004) and HQUSACE (1995d). Information on instrumentation for concrete dams is given in HQUSACE (1995b) and HQUSACE (1987).

Full reliance shall not be placed on instrumentation alone to find problems or to forecast performance, since it is impossible to install sufficient

instrumentation to monitor every possible problem area. An extremely important part of the monitoring program is visual observation to determine evidence of distress and unsatisfactory performance (Mahoney 1990). Project personnel shall receive training in basic engineering considerations pertaining to major structures, with procedures for surveillance, monitoring, and reporting of potential problems, and with procedures for emergency operations.”

Specific requirements for instrumentation can be found in the appropriate USACE guidance previously referenced (i.e., EM and/or EC, engineering manuals and circulars, respectively). EM documents previously referenced are periodically updated, thus the year of reference may change after publication of this study. The most recent guidance should be consulted and reviewed at the USACE Website: <http://publications.usace.army.mil/USACEPublications/EngineerManuals.aspx>.

5.2 Instrumentation and monitoring approach

Geotechnical instrumentation can be broken into two categories: in situ determination of soil or rock properties and monitoring of performance during extreme loading events. The second category is where this review will focus. Geotechnical instrumentation can be used to measure deformation, seismic loading, groundwater pressure, total stress in soil, stress changes in rock, and temperature. This information is vital to the design and operation of geotechnical structures and helps ensure that the structure performs as intended and should be used together with a thorough understanding of site geology and groundwater conditions. The focus of this chapter is remote monitoring of dams and levees during extreme loading events.

5.3 Planning and design

The needs for geotechnical instrumentation are many, and a properly defined and implemented instrumentation plan can help overcome geotechnical uncertainty. Instrumentation can ensure long-term safety by providing data to monitor the performance of the dam or levee over the design life. They can help define the need for and the adequacy of remediation efforts before and after extreme loadings. Placement is vital, the wrong instrument in the wrong location can cause confusion or distract from other issues that may be developing. Each instrument placed must have a specific purpose. A rule of thumb when developing an instrumentation plan is to

have a particular question for each instrument that is being installed. Table 5-1 gives a systematic approach to instrumentation planning and developing a monitoring program.

Table 5-1. Steps in systematic approach to planning monitoring programs using geotechnical instrumentation (ICE 2012).

1	Define the project conditions
2	Predict mechanisms that control behavior
3	Define the geotechnical questions that need to be answered
4	Identify, analyze, allocate and plan for control of risks
5	Select the parameters to be monitored (displacement, water level, pressure etc.)
6	Predict magnitudes of change
7	Devise remedial action
8	Assign tasks for the construction phase
9	Select instruments
10	Select instrument locations
11	Plan documentation of factors that may influence measured data
12	Establish procedures for ensuring data correctness
13	List the specific purpose of each instrument
14	Prepare budget
15	Prepare instrumentation system design report
16	Plan installation
17	Plan regular calibration and maintenance
18	Plan data collection and data management
19	Prepare contract documents
20	Update budget

Planning an instrumentation program should begin with identifying the objective of the instrumentation plan and end with planning how the gathered data will be used and the parameters (i.e., displacement, translation, settlement, rotation, water level or elevation, pore pressure, cracking, volumetric changes, and change in seepage condition) to be studied. Each of these steps is well defined in Dunnycliff (1993) and ICE (2012). As part of the planning process, it is important to identify threshold values that, once reached, will trigger initiation of a certain preplanned action. Often a traffic light system is used (see Table 5-2).

Table 5-2. Traffic light system used to define threshold values.

Color	Condition
Green	Embankment is performing as intended
Amber	Increased monitoring is necessary and calculations may need to be reviewed and contingency measures may need to be initiated if trends indicate that the red threshold may be reached shortly
Red	Indicates that immediate contingency and emergency measures must be taken

Defining threshold values is an important aspect of the instrumentation process, especially when considering a dam with a heavily populated region downstream. Defining the Amber and Red threshold levels should be based on calculated values and tolerable performance.

Remote monitoring plays a vital role when using the “Observational Method” in new construction, but it also plays a vital role during the life of the structure. Data collected from geotechnical instruments allow for timely design and remediation modifications to these structures before failure is reached. The placement and monitoring of geotechnical instrumentation can also yield important information, which can be used to buy down risk. The careful review of past and present instrumentation data, in addition to geologic and design information, will aid in the identification of the severity of failure modes that impact geotechnical structures. Once the severity of the failure modes is identified, remediation efforts can be focused where they are needed most. Early remediation of design issues decreases the cost and time associated with these activities and ensures future performance of the structure. Properly managed data extracted from well-placed instruments can validate critical assumptions and address the likelihood of a particular failure mode.

Possible failure modes a dam or levee may encounter include overtopping, internal erosion (piping), rotational slope failure, and liquefaction from earthquakes. During an extreme flood event, the level of water that the embankment encounters may exceed those expected by the original design. This extreme loading would cause water to flow over the embankment and erode material, or cause slope instability, which could lead to failure of the embankment. Internal erosion or piping occurs when seepage water is flowing at a sufficient velocity to carry soil particles with the water. Rotational slope failure can occur when the dam or levee is constructed over a foundation of soft soil. If the dam or levee is built on loose granular

material, a seismic event may cause the foundation to liquefy and flow, which may lead to complete or partial failure of the structure. These examples are only a few of the many failure modes that a dam or levee may encounter. There may be unforeseen circumstances or design flaws that contribute to more site specific failure modes. With these failure modes in mind, Dunicliff (1988) made suggestions regarding the proper instruments for monitoring (Table 5-3).

Table 5-3. Instrumentation suggestions (Dunicliff 1993). (Courtesy of Wiley & Sons. Requests for permissions or further information should be addressed to the Permissions Department, John Wiley & Sons, Inc., 605 Third Avenue, New York, NY, 10158-0012).

Measurement in Priority Order	Recommended Instruments	Additional Instruments for Special Cases
Condition of entire structure	Visual observations	UAV, imagery
Leakage emerging downstream	Leakage weirs Precipitation gage	
Performance of relief wells	Leakage weirs Open standpipe piezometers	
Seismic events	Strong motion accelerographs Microseismographs	
Pore water pressure within the embankment	Open standpipe piezometer Twin-tube hydraulic piezometers	Vibrating wire piezometers Pneumatic piezometers
Vertical movement of the embankment surface	Optic leveling Trigonometric leveling Satellite-based SAR Benchmarks	
Lateral movement of the embankment surface	Electronic distance measurements Triangulation Satellite-based SAR and imagery Horizontal control stations	
Vertical deformation within the embankment	Single-point and full-profile liquid level gages, overflow type Double fluid settlement gages Horizontal inclinometers Elevation benchmarks	Probe extensometers, installed vertically
Lateral deformation within the embankment	Probe extensometers with multiple induction coil or magnet/reed switch transducers, connected by rods and installed horizontally Horizontal control stations	Fixed embankment extensometers with vibrating wire transducers, or induction coil transducers with frequency output Inclinometers
Total stress at contact between the embankment and a structure	Contact earth pressure cells	

The current trend in geotechnical instrumentation is the automation of instruments in the field and remote monitoring of these instruments over the internet. This technique can help decrease the costs associated with retrieving data, but it is still necessary to inspect the system and the site periodically. It is also important to know the reliability of the instruments that are used. Often the simplest instrument will yield reliable results over the lifetime of the instrument. Attention should be focused on reliability of the instrument with time, especially in terms of system electronics and aging.

5.4 Seismic sensors and measurements

5.4.1 Types of sensors

Three types of seismic sensors have historically been used for seismic monitoring of strong motion events at USACE dams: accelerographs, seismic alarm devices (SAD), and nonelectric peak accelerograph recorders (HQUSACE 1995d). An accelerograph measures acceleration triaxially at the instrument location. Placement of the instrument is typically at the base of the dam, at the crest, and at a free-field location nearby, where ground motions are not influenced by the structure. A rock or high terrace abutment adjacent to the dam is often used as a free-field location. The horizontal components of the accelerometer axis are typically aligned with the orientation of the structure, such that one axis is parallel and the other is perpendicular to the dam axis. The third axis measures the vertical component of motion.

Historically, 70-mm film-type sensors were first used in accelerograph instruments to measure strong motion earthquake events. Film technology was later replaced by an analog sensor recording to a local drive. A technician was required to extract the data from the accelerograph following each major event. Historically, analog sensors were used to measure strong motion earthquake events that exceeded 0.02 g (g = unit of acceleration, where 1 g = 9.81 m/sec²). Advances in technology and the current state-of-practice uses a three-axis, digital accelerometer, connected to a remote monitoring system. Force balance accelerometers such as Kinemetric's EpiSensor ES-T, or equivalent are typically used for seismic monitoring at USACE dams. Detection thresholds have improved significantly with digital sensors, which are now governed by the electronics of the sensor, and can be set depending on the resolution and noise level to be filtered. Most film records of strong motion events have been digitized and converted into a

digital format for capture into a database for later use in seismic analysis of structures.

SAD sensors are used to measure and display a peak vertical acceleration in a wall-mounted unit that is easily read by site personnel at the dam. The wall unit can be connected to an alarm system that provides both telephone and email alerts to site personnel following an event. This simple device provides basic early warning capabilities to alert critical personnel that a large event was recorded. The range for these devices is between 0.05 to 0.5 g.

Nonelectric peak accelerograph recorders are passive devices that record acceleration peaks triaxially onto metal strips or magnetic tapes with a sensitivity as low as 0.01 g. These devices have been used to provide redundancy to electric accelerograph technology for events greater than 1.0 g.

5.4.2 Requirement for strong motion instrument

Strong-motion instrumentation is required on USACE dams for seismic risk zones 2, 3, and 4 of the Seismic Risk Maps (HQUSACE 1981). Seismic risk zone maps of the United States are based on the presence of active and capable faults and the historic record of earthquakes. Earthquakes are produced by fault movements, which are caused by the release of strain energy within the shallow crust, due to the collision and interactions of the large tectonic plates that form the earth's crust and the resulting strain energy that is produced. Seismic considerations for the eastern and western United States are fundamentally different in terms of the geology, tectonism, and the historic earthquake record. In general, the western United States contains both active and capable faults with a record of earthquake activity during the Holocene (<10,000 years), while in the eastern United States, no active and capable faults have been identified to date. Large eastern United States earthquakes are typically associated with "seismic hot spots," or zones where moderate to large seismic events have occurred during historic time (e.g., New Madrid, MO; Charleston, SC; Giles County, VA; Cape Ann, MA; LaMalbaie-Charlevoix, Canada, along the St. Lawrence Seaway).

USACE dams are generally considered to be a critical structure because of the population at risk below the dam. Consequently, they are designed to survive a maximum credible earthquake (MCE) from different tectonic

sources. A maximum design earthquake (MDE) is specified for the dam site, which is characteristic of the geology and tectonism at the dam site. Another important parameter for the design of the structure is the operating basis earthquake (OBE), which is largest earthquake that is projected to occur during the life of the structure, normally taken to be the largest earthquake event to be felt by the structure during its service life of 100 years (HQUSACE 1995d).

5.4.3 Requirement for periodic seismic evaluation

USACE guidance requires that a seismic review of the structure occur at least every third periodic inspection or at a minimum of every 15 years to determine whether any changes or advances have occurred in the science of earthquake engineering with respect to the local geology and tectonism (HQUSACE 1995d). Requirements for periodic inspection are described in detail in HQUSACE (2011). A source of concern for many older dams, including those built and operated by the USACE, is the liquefaction potential of embankment structures built upon pervious alluvial foundations.

5.4.4 Historical earthquake records

Earthquake records are an important component for use in an engineering analysis. The analysis involves simple pseudo-static evaluations to more complex dynamic evaluations using finite element to determine the structural response from the earthquake events (HQUSACE 2011). Historical records from past earthquake events are normally used in complex seismic evaluations of a structure and are typically matched to the geology, soils, the MCE, the OBE, and whether the motions are in the near field or far field. The size, distance of the earthquake (triggering fault) to the structure, focal depth, geology, and the attenuation characteristics of the high frequency component of the motions governs whether near or far field conditions occur at the site. Parameters of interest for engineering analysis are the peak ground acceleration (PGA), displacement, and duration of the seismic event.

ERDC and the USGS initiated coordination on strong-motion instrumentation in the 1970s. Since 1978, ERDC has been responsible for installing and maintaining approximately half of the USACE instruments on dams, which are located in the central and eastern United States. The USGS provides field maintenance for instruments west of the Rocky Mountains. The

ERDC-USGS arrangement is still in effect today. A total of 127 USACE projects, located in 31 states, are instrumented. The instruments in operation comprise 1,278 accelerograph channels (732 or 57 percent of which are digital), 39 peak recording accelerographs, and 38 seismic alarm devices (USACE 2005). This monitoring technology continues to enhance the safety of USACE structures, and provides earthquake data for later research to improve the seismic safety of the structures. Alarm devices used by USACE on some of their structures are a simple sensor technology that provides an alert when a triggering event occurs to notify the public and first responders that inspection of the structure is required.

Both the USGS and ERDC maintain records of earthquake events. Another source for digital earthquake records is provided by the Consortium of Organizations for Strong-Motion Observation Systems (COSMOS) at <http://cosmos-eq.org/>. COSMOS was formed in 1999 by the National Science Foundation-funded U.S. Committee for the Advancement of Strong Motion Programs (CASMP) and was established at the Pacific Earthquake Engineering Research (PEER) Center, University of California, Berkeley. COSMOS members include the California Division of Mines and Geology, USGS, USBR, and the USACE (www.cosmos-eq.org). This repository of earthquake records is one of several sources available in the United States.

5.4.5 Remote monitoring and network security

Remote monitoring of seismic sensors has become a significant challenge for incorporation into networked Ethernet systems in USACE. The security of these systems is controlled by the U.S. Army Corps of Engineers Information Technology (ACE-IT), which is not focused on geotechnical engineering, but rather on cyber security considerations. Consequently, placement of sensors and other types of data devices must be cleared and approved before network access is permitted. This process is time consuming and, because of the remote nature of the sensors involved, requires careful evaluation by ACE-IT for efficient system integration. An example where successful integration of seismic sensors within today's security environment has occurred is at Mount Morris Dam in New York (USACE 2011d). Seismic sensors were placed inside the firewall. However, these sensors are within the structure, which has restricted access.

5.4.6 Seismicity of levees

Seismic monitoring and engineering evaluations have been routinely performed for USACE dams. However, seismic monitoring and evaluations of USACE-owned levees are not ordinarily conducted. The reason being the coincidence of a maximum flood and a large magnitude earthquake event at the same time is a fairly remote event and is not likely. Consequently, the cost to increase the levee standard to withstand an earthquake is not economically practical for a large levee extent potentially impacted and normally in the dry state. Thus, HQUSACE (2000) policy for levees does not consider seismic loading.

An underlying factor in the formation of this policy is the history of legacy levee construction across most of the United States. Most legacy levees were not built to modern-day construction practices and quality control standards in use today. Additionally, a major factor is the widespread occurrence of floodplain soils (i.e., point bar deposits) and their liquefaction potential, which makes economic justification for seismic issues nearly impossible to achieve for the vast majority of the nation's river systems. Thus, the expenditure of public funds to make levees earthquake proof is not a realistic option economically for the majority of the nation's river systems.

As an example, the three largest earthquakes in the central United States occurred at New Madrid, MO, December 1811 (magnitude ~7.7), January 1812 (Magnitude ~7.5), and February 1812 (Magnitude ~7.7). These events were some of the most destructive earthquakes in U.S. history. If these earthquakes occurred today, levees along the Mississippi River in the epicentral area would likely experience significant liquefaction failures within the foundation substratum sands and result in severe damage to these levees.

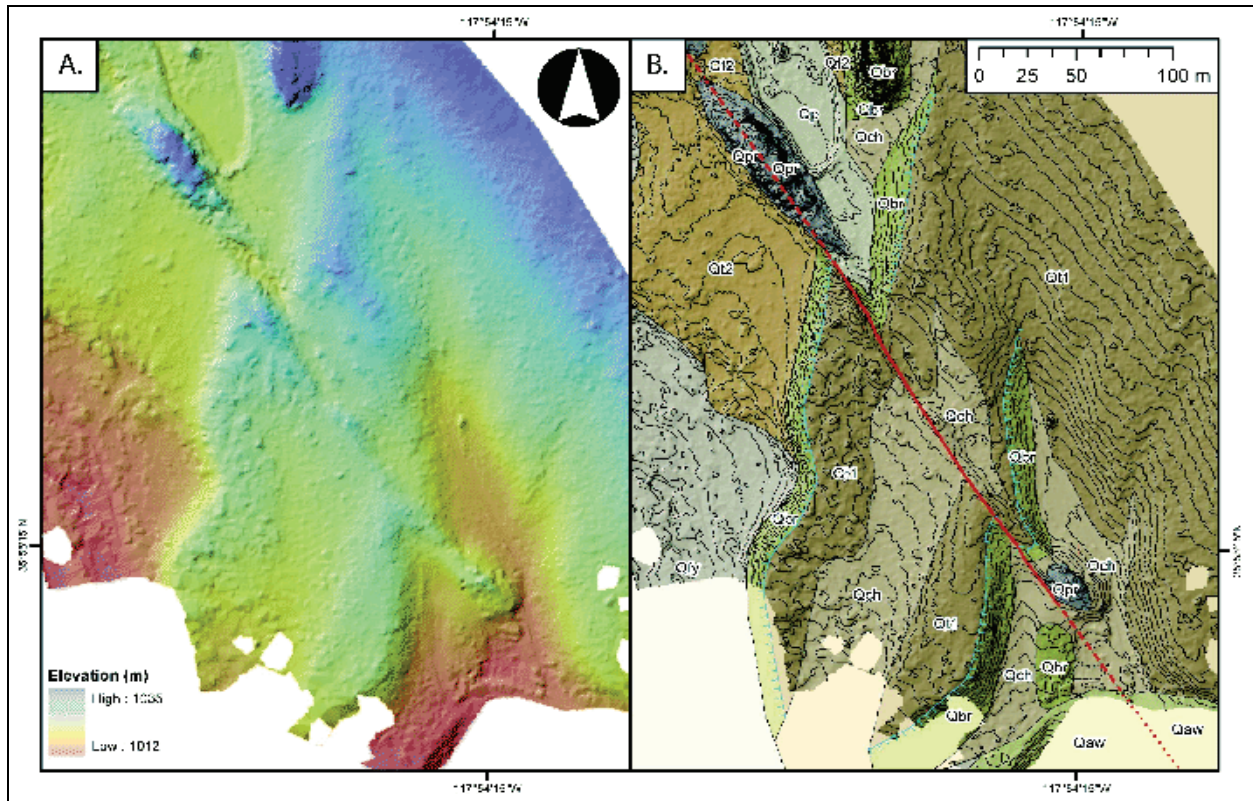
The California Department of Water Resources has considered seismic hazards of their levees as part of the Urban Levee Assessment program in the greater Sacramento area (URS 2007). The focus of these engineering studies has included the consideration of risk reduction measures for seismic loadings where remediation efforts are planned for different failure modes for overtopping, slope stability, and/or seepage. Cost-effective seismic risk reduction measures may be possible with only minimal expenditure of additional funds to remediate the levee systems against seismic related hazards. The idea is to potentially reduce seismic risk related damages, but not eliminate the threat entirely with only minimal remediation costs.

5.5 Surface deformation sensors

5.5.1 Terrestrial Laser Scanning (TLS or Terrestrial LiDAR)

TLS uses LiDAR technology to calculate the distance between the scanner and the target by measuring the time delay between the emitted and reflected signal. Geo-referencing is done with known targets placed throughout the collection environment. Deformation is measured by placing targets at the area of interest. TLS accuracy is calculated by systematic and random error, which translates to an accuracy of ± 0.2 in. (5 mm) at 82 ft (25 m), to ± 1.2 in. (30 mm) at 3,280 ft (1,000 m). Random errors affect the precision of the instrument, which are generally 0 to 0.4 in. (0 to 10 mm) regardless of distance. Some of the advantages of this type of system are that it is a fast nondestructive technology, and data collection can be integrated with construction projects or implemented in remote regions. Some disadvantages are that it is an emerging technology with variable equipment and processing options (Lato 2012). Figure 5-1 is an example of the type of data that can be acquired using terrestrial laser scanning.

Figure 5-1. Example 50-cm DEM dataset as hillshade image (left image) from topographic survey using a Riegl LMS Z420i terrestrial laser scanner in a fault study from California (Amos et al. 2013). DEM image shows topographic offset on the Little Lake Fault, California. Geologic map (right image) shows fault trace (red line) and offset in Holocene terrace deposits.



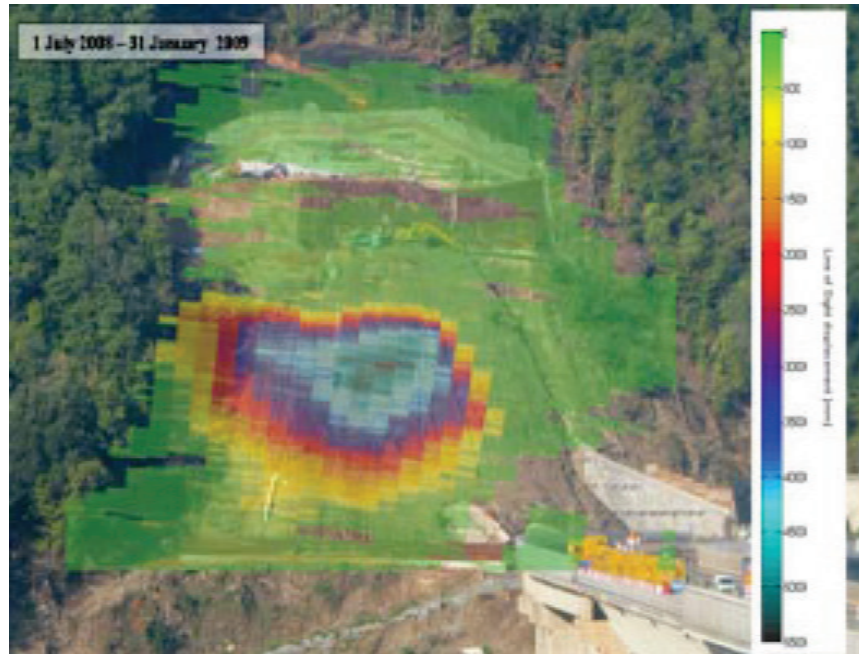
5.5.2 Terrestrial Interferometric Synthetic Aperture Radar

Terrestrial Interferometric Synthetic Aperture Radar (TInSAR) is a RADAR technique for remote monitoring of displacements. A RADAR sensor is moved along a rail, which allows precise movement of the sensor. Two-dimensional (2-D) SAR images are derived from these surveys.

Displacements are calculated from the comparison of phase difference of each pixel between two or more SAR images. TInSAR can also be installed in a stable position, and it also does not require the installation of contact sensors or reflectors. The accuracy of this system is theoretically on the order of ± 0.004 in. (0.1 mm), but is strongly reduced by atmospheric noise. The main advantage of TInSAR is its ability to monitor displacements from remote locations without the installation of targets or sensors. Some of the other advantages include the applicability under any lighting conditions, high data sampling rate, long range efficacy, and high accuracy and spatial control. The main disadvantage is the complex management, processing

and interpretation of TInSAR data (Massanti 2012). An example of the type of data collected with TInSAR is shown in Figure 5-2.

Figure 5-2. Example of data collected with TinSAR (Massanti 2013).



5.5.3 Total Station (TS)

A total station is a theodolite with an EDM (electronic distance meter). There are a range of instruments available with varying accuracies. It is recommended to use instruments with angular measurement accuracies to within 1 sec and distance measurements to within 1 mm per 100 m for highest quality. There are less accurate instruments available at lower cost, but these instruments are less robust and may have unacceptable built-in inaccuracies. More accurate instruments are also available at higher cost and can be more sensitive to atmospheric conditions. A disadvantage of the manual total station compared to the robotic total station (RTS) is that a field crew must be used in order to make readings (Basset 2012; Hope 2008).

5.5.4 Reflectorless Robotic Total Stations (RRTS)

The RRTS instrument is similar to the RTS system with the difference being that it is fitted with a reflectorless distance meter. This addition allows for reflectorless surface point (RSP) measurements. RSPs are not physically marked or physical objects, but are just locations on the ground. Reflectors are not necessary for all points. The range of the distance meter is limited to 197 to 230 ft (60 to 70 m) (Tamagnan and Martin 2011).

5.5.5 Automated Robotic Total Station (ARTS)

Automated robotic total stations (ARTS) are remotely operated theodolites, which deliver continuous survey measurements on reflective prismatic targets. These instruments combine a theodolite (with Automatic Target Recognition) and electronic distance measurement. The ARTS can monitor points in 3-D space by sighting prisms and following them as movements occur. Monitoring cycles are set up with a series of targets established and, at set times, the RTS will sight each target. The instrument sights the prismatic target and sends an IR beam that is reflected back to the instrument. This reflected beam is then analyzed by the instrument to ascertain the center of intensity. The motors on the machine then move to refine the instruments position and lock on to this point. Both angular and distance measurements are then made, which allow for the calculation of the current prism location. The accuracy of the ARTS with the best available instrument and installed properly is ± 0.02 in. (0.5 mm). The main advantages of the ARTS are that they deliver high quality survey data from a fixed location and with little manual field effort. The main limitations are due to the optical nature of the instrument; performance can be hindered by weather changes, atmospheric conditions, suspended particulate, traffic, and vibrations (Cook 2006; Marr 2008; Nyren et al. 2012). An example for monitoring deformation in buildings along a busy street is shown in Figure 5-3. This application has reflectorless surface points that are monitored 24 hours a day.

Figure 5-3. Example of remote monitoring of surface deformation using a robotic total station mounted to a building (Tamagnan and Beth 2012).

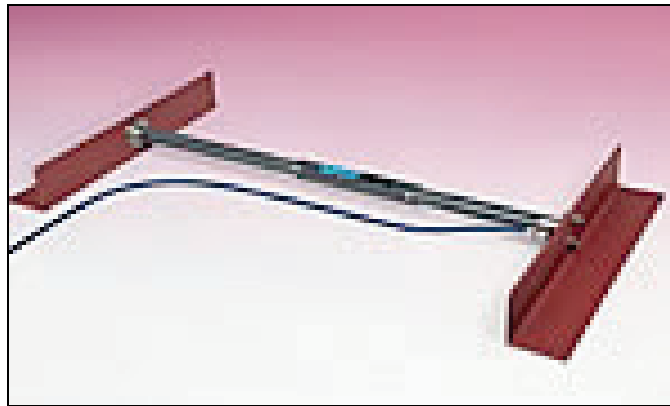


5.5.6 Vibrating wire soil extensometer

The vibrating wire instrument works on the frequency of a wire fixed between two points on the surface to measure movement between the points. The variables that impact the frequency are the length of the wire, the mass of the wire, the elastic characteristics, and the tensile force in the wire. The length, mass, and elastic characteristics of the wire are usually set, while the tension is the measured variable. A small induction coil is placed near the center of the wire. This coil is used to stimulate the wire with a short burst of alternating current (AC) near the natural frequency of the wire. While the wire is vibrating, the coil will respond with an identical AC frequency for the vibrating wire. Two flanges are attached to both ends of the vibrating wire system and as the flanges separate, the wire is subjected to increasing tensions causing the fundamental frequency of the wire to increase. If the system is computer controlled, the excitation can be carried out a number of times and the average value will give a more accurate reading. Standard ranges for this equipment (as listed for Geokon model 4435) are 25, 50, 100, 150, and 300 mm. The system was designed to be installed in series to measure horizontal strain and settlements in earth-fill and rock-fill dams. The accuracy and resolution of this instrument is

± 0.1 percent Full Scale (F.S.) and 0.025 percent F.S. as reported by Geokon (2012). This type of instrumentation is an improvement over other techniques for surface or near surface deformations. The system can be installed in series to measure deformations over a larger continuous area as compared to point measurements taken with a linear variable differential transformer (LVDT) or a direct current differential transformer (DCDT). Figure 5-4 shows an example of this type of instrument (Geokon 2012).

Figure 5-4. Vibrating wire soil extensometer (Geokon 2012).



5.5.7 Vibrating wire displacement transducer

The vibrating wire displacement transducer is designed to measure displacements across joints and cracks in concrete, soil, and rock. The transducer consists of a vibrating wire in series with a tension spring. Displacements are indicated by a stretching of the tension spring, which increases the tension in the vibrating wire and changes its frequency. The wire and spring configuration are connected to a sliding rod, which can physically move as displacements occur. The frequency signal emitted from the vibrating wire is transmitted to the readout location and is displayed on portable readouts or data loggers. Figure 5-5 shows an example of this type of instrument (Itmsoil 2012).

An advantage of the vibrating wire displacement transducer is that the linear displacements are transmitted from the instrument as frequencies. Frequencies are easily transmitted over long lengths of electrical cable with minimal degradation caused by variations in cable resistance or leakage to the ground. The accuracy and resolution of this device are similar to the vibrating wire soil extensometer.

Figure 5-5. Example of a vibrating wire displacement transducer (Itmsoil 2012).



5.5.8 Tiltmeters

Tiltmeters are used to measure the change in inclination or rotation of points on the ground surface (or structure). These instruments can either be fixed in place or arranged as portable devices. Unless there is a rotation expected during deformation, settlement measurements are more common. Two of the newer instruments are described in the following section.

5.5.8.1 MEMS tiltmeter

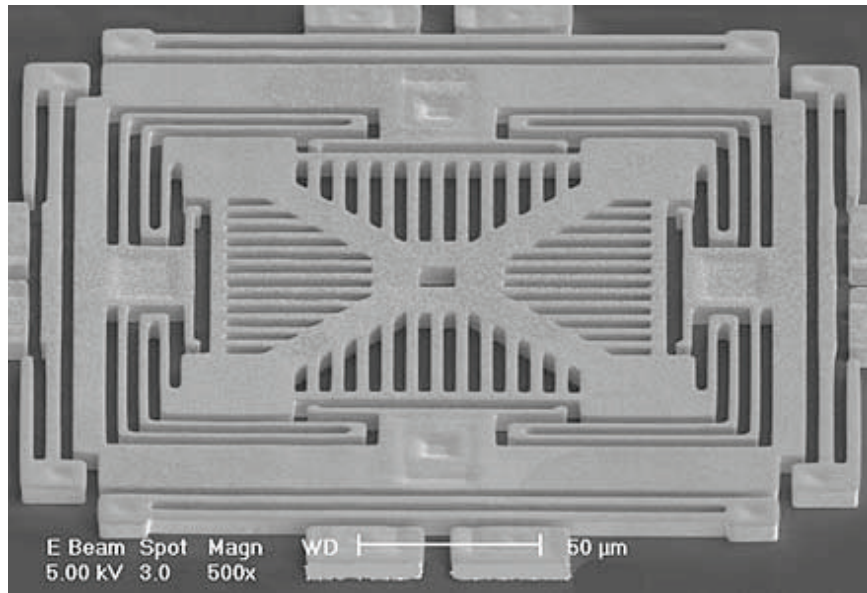
Micro-electro-mechanical system (MEMS) tiltmeter is equipped with a MEMS sensor, which provides the most advanced and current technique in deformation measurements. The sensor is an accelerometer (based on capacitance changes) etched on a glass/ceramic chip. Figure 5-6 shows an example of the MEMS sensor (Guillou 2003). The instrument has a range of ± 10 to 15 deg from the vertical and is available in uniaxial or biaxial versions. Signal processing makes the tiltmeter compatible with most data loggers. The accuracy of this device is in the range of ± 0.1 percent full scale (F.S.), and the resolution is ± 0.01 mm/m (± 2 arc sec).

5.5.8.2 Vibrating wire tiltmeter

The vibrating wire tiltmeter works similarly to the vibrating wire extensometer at rest with the principal difference is that tension is applied to the wire. A pendulous mass attempts to swing under the force of gravity on an elastic hinge, but the vibrating wire restricts motion. As the tilt increases or decreases, the mass attempts to rotate and the tension in the vibrating wire alters the frequency. Frequency is then converted into angular

displacements by using a calibration constant. The tiltmeter is designed to measure tilt in dams, earthen embankments, and slopes. The accuracy of this device is reported to be ± 0.1 percent F.S. and the resolution is ± 0.5 mm/m (9 arc sec).

Figure 5-6. Example of a MEMS accelerometer (Guillou 2003).



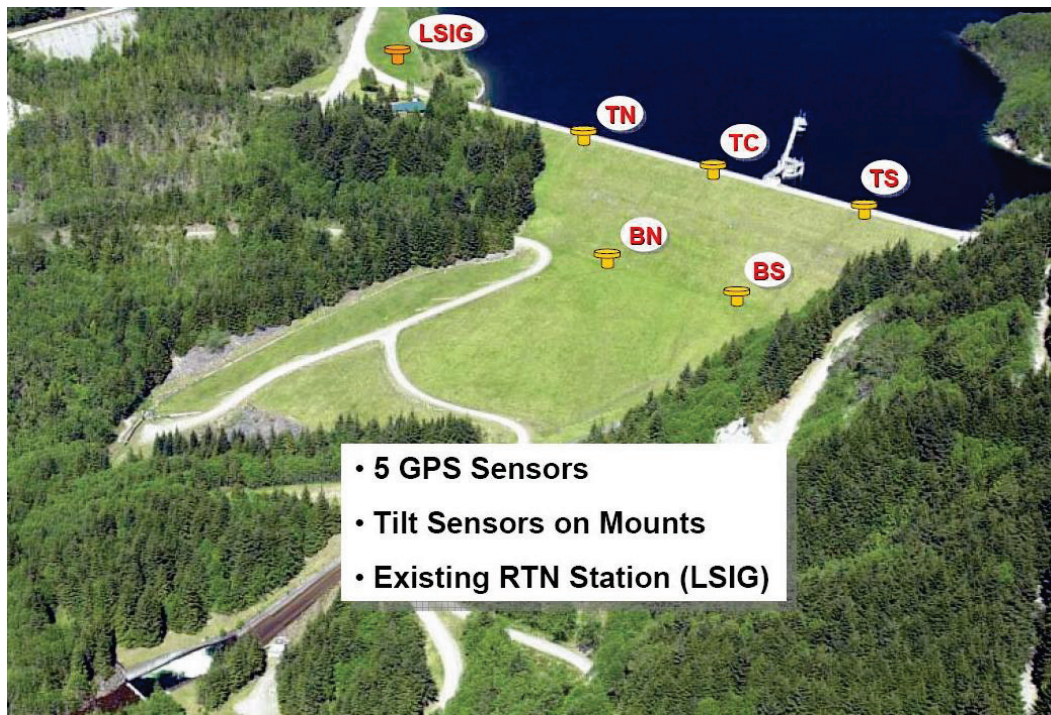
5.5.9 Global positioning system (GPS)

GPS consists of three parts: satellites, a ground control network, and user equipment. Radio signals are used in an interferometric mode. Two or more GPS receivers simultaneously receive signals from the same set of satellites, and the resulting observations are subsequently processed to obtain inter-station difference in position. If one of the receivers is placed at a known location, the 3-D position of the second receiver may be determined, and the number of stations determined simultaneously is limited by the number of receivers available (ICE 2012).

GPS is a useful tool for monitoring movement of dams and levees over long periods of time. The accuracy is in the range of ± 1 cm horizontally and ± 1.5 cm vertically. Advantages of the GPS system are that line of sight is not required between stations, 3-D position information is provided to a high level of accuracy, and position is referenced to outside of the site. Disadvantages of the system are that overhead obstructions can limit satellite reception and the systems can use a lot of power. Continuous monitoring of fixed-position sites permits monitoring of long-term displacements in both the vertical and horizontal axis.

GPS technology enables long-term monitoring of landslides and tectonic areas where crustal deformation is occurring, especially in remote areas. An example of monitoring for engineering and tectonic displacements is an array of GPS monitoring stations in the Pacific Northwest by the Cascadia Hazards Institute (Central Washington University 2013). Monitoring of Tolt Dam in Figure 5-7 is an example of active GPS monitoring.

Figure 5-7. Example of continuous GPS monitoring of Tolt Dam (Central Washington University 2013).



5.6 Subsurface deformation sensors

5.6.1 Inclinerometers

Inclinometers are devices that are typically used to measure small-scale horizontal and vertical deformations in the subsurface of the soil. This instrument is often used to evaluate the stability of a slope or an excavation. These types of instruments can be used to find the surface and direction of sliding if more than one instrument is used in an area of sliding. They can also be used to measure deflections of vertical retaining walls or bulkheads. Interpretations into the cause for sliding can be determined in conjunction with data available from other instruments, such as piezometers and weather station instruments. This section will focus on two types of inclinometers. The first type is the conventional inclinometer, which must be operated manually. The second type is the in-place inclinometer, which is

intended to be operated remotely. The in-place inclinometer uses advanced electronics to mimic the manual data collection methods of the more conventional inclinometer.

5.6.1.1 Conventional Inclinometer

The basis for operation of a conventional inclinometer is fairly simple and straightforward. The major parts of an inclinometer system are shown in Figures 5-8 and 5-9. These include:

- A guide casing usually made of plastic
- A portable probe with two tiltmeters oriented 90 deg apart
- Electrical cable, which transmits the output of the tiltmeters to the readout unit
- A readout unit to record the depth and the angles of inclination in the x and y directions for data processing

Figure 5-8. Photograph of an inclinometer system (DGSI 2009).

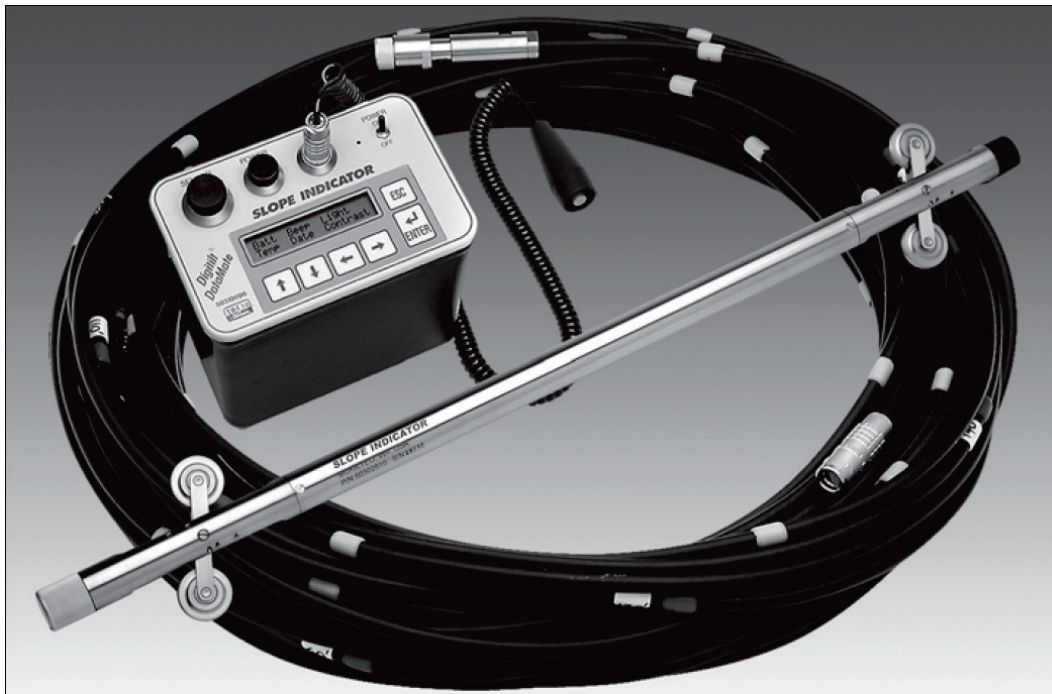
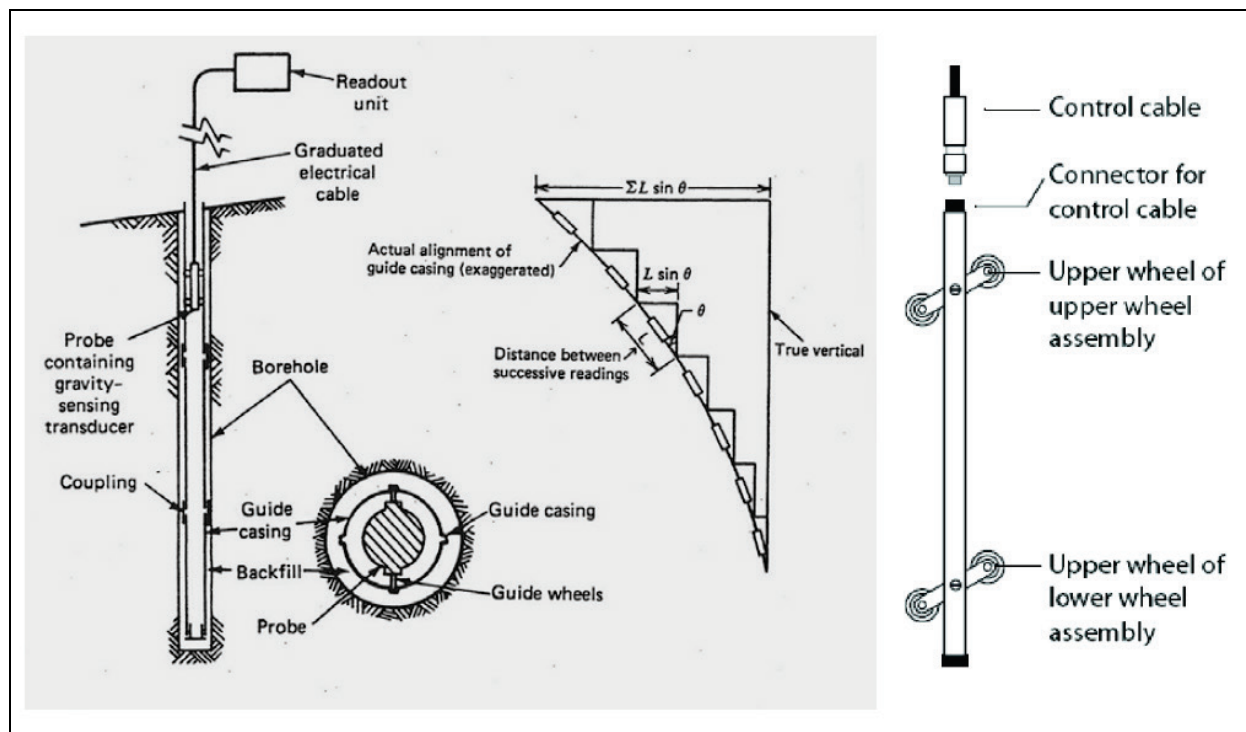


Figure 5-9. Schematic drawing showing inclinometer operating principles (Mikkelson 2003).

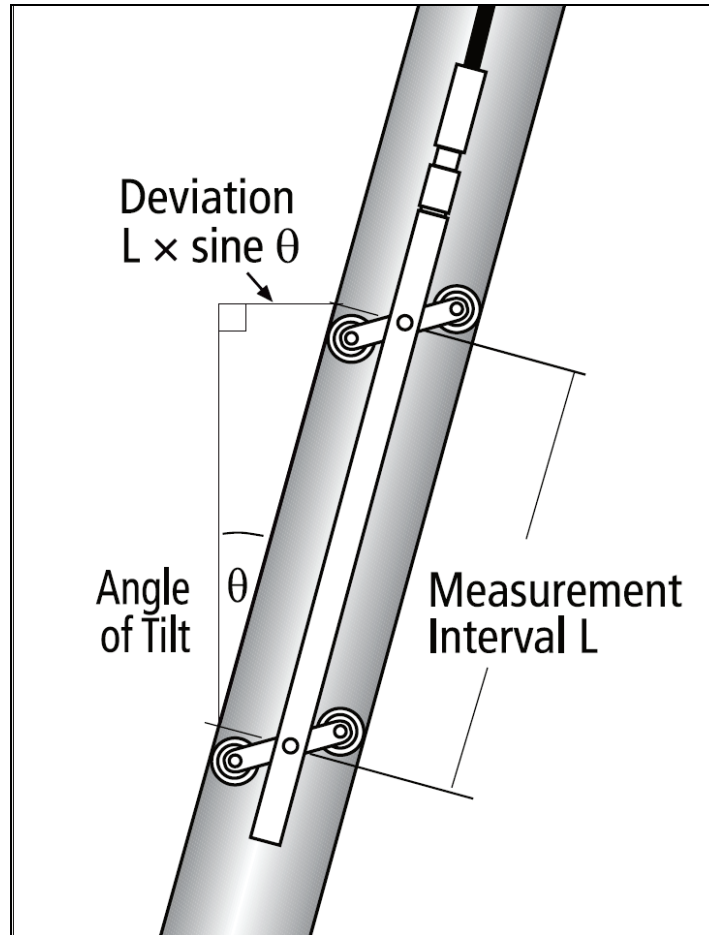


The guide casing should be installed in a nearly vertical borehole. The idea is that the guide casing will move the same as the ground around it. This hole should be of sufficient depth to extend into stable ground. At this depth, there is no displacement as the soil above it moves. Stable ground below the zone of movement serves as a datum from which all of the measurements can be referenced. The guide casing has grooves or tracks, which allow some control of the casing orientation. Guide casings are available in different diameters, with the larger diameter casing able to tolerate more movement before breaking. The annular space between the natural soil and the guide casing is filled with grout.

The probe is a rod of length (L) with two wheels that ride in the tracks of the guide casing as the depth of the instrument changes. As shown in Figure 5-10, the length of the probe is equal to the distance between the wheels, which is typically either 24 in. or 0.5 m. The wheels will keep the probe oriented with respect to the casing because they travel in the same grooves of the guide casing. The probe contains two tiltmeters that are able to sense deviations from the vertical direction. One of the tiltmeters will measure deviation angle from the vertical in the plane of the wheels and

the other will measure the deviation angle in a direction oriented 90 deg from the plane of the wheels.

Figure 5-10. Calculation scheme for estimating interval deviation in x-direction (DGSJ 2009).



The cables bring the electrical signals from the tiltmeters to the ground surface, where they are read, recorded, and stored in the readout unit. The cable is also designed to designate the depths at which readings should be taken as it contains mark distant points, L , that are equal to the depth of the probe. The depth of the investigation will be limited by the length of the cable. The cable contains mark points separated by a distance, L , which is equal to the length of the probe. Cable lengths of 100, 150, and 300 ft and 30, 50, and 100 m are available.

Readout units are needed to recover the output of the tiltmeters. Readout units are available that record the tiltmeter output to a screen, and the data are recorded for later display. The measurement process begins with the first/initial set of readings, which is taken immediately after the guide

casings are installed in the boreholes. These initial readings establish the original positioning and orientation of the guide casing as a function of depth. All subsequent measurements will yield displacements that are relative to these initial readings.

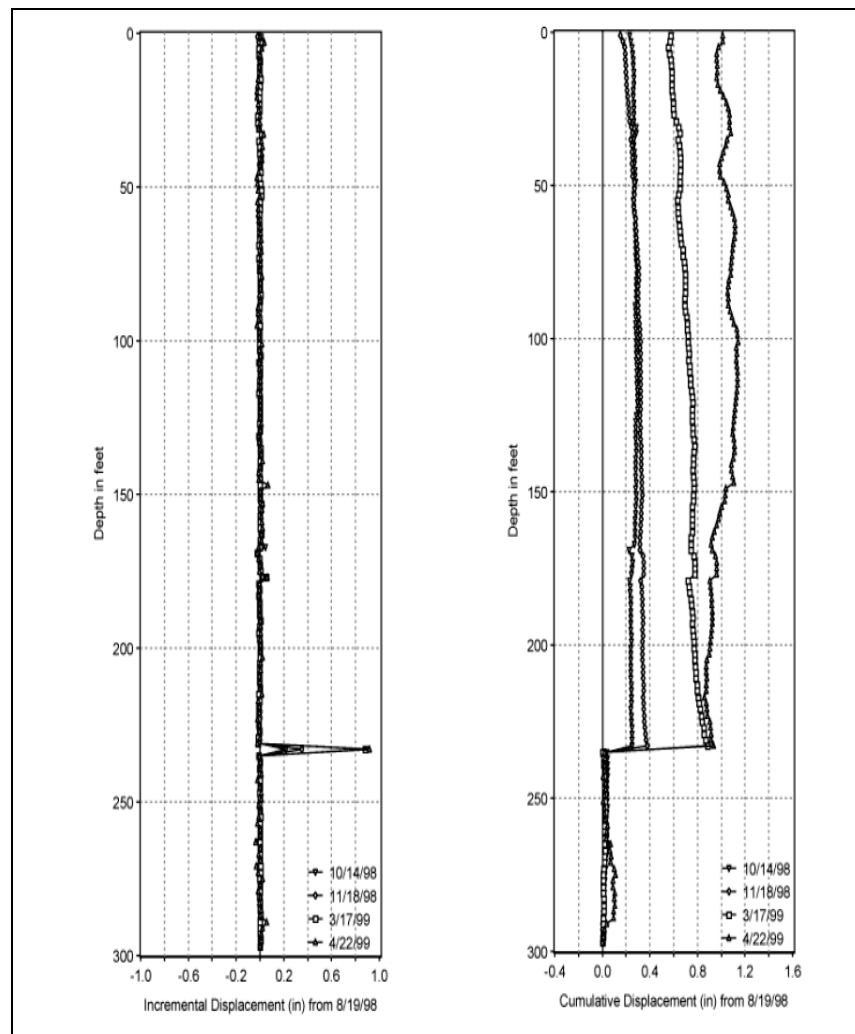
The test procedure for any time (t) is set to begin with the depth at the bottom of the casing where the first reading is taken. As shown in Figure 5-9, subsequent readings are taken by moving to the top of the hole in increments set equal to the length, l , of the probe. Readings should be taken at depths consistent with the graduations on the cable. The incremental displacements are calculated as the product of the sine θ (deviation angle from vertical) multiplied by L for each measurement interval. By assuming the bottom of the hole is in stable ground, where the ground displacements are zero, the cumulative displacements in each hole can be determined as a running sum of the incremental displacements from the bottom of the hole as shown in Figure 5-9.

The results from typical inclinometer measurements are presented in Figure 5-11 and show the results of measurements made at four different times. The incremental displacement plots show the change in displacement as a function of depth, whereas the cumulative displacement plot represents the actual displacements (relative to the initial displacements) as a function of time. In the presentation plot, the incremental displacement and cumulative displacements show there is a distinctly defined shear surface at a depth of about 235 ft, which is increasing with time. Additionally, the cumulative displacement plot shows that this displacement has a magnitude of about 1 in. relative to the lower depths of the borehole, which is presumed to be stable.

5.6.1.2 *In-place inclinometer*

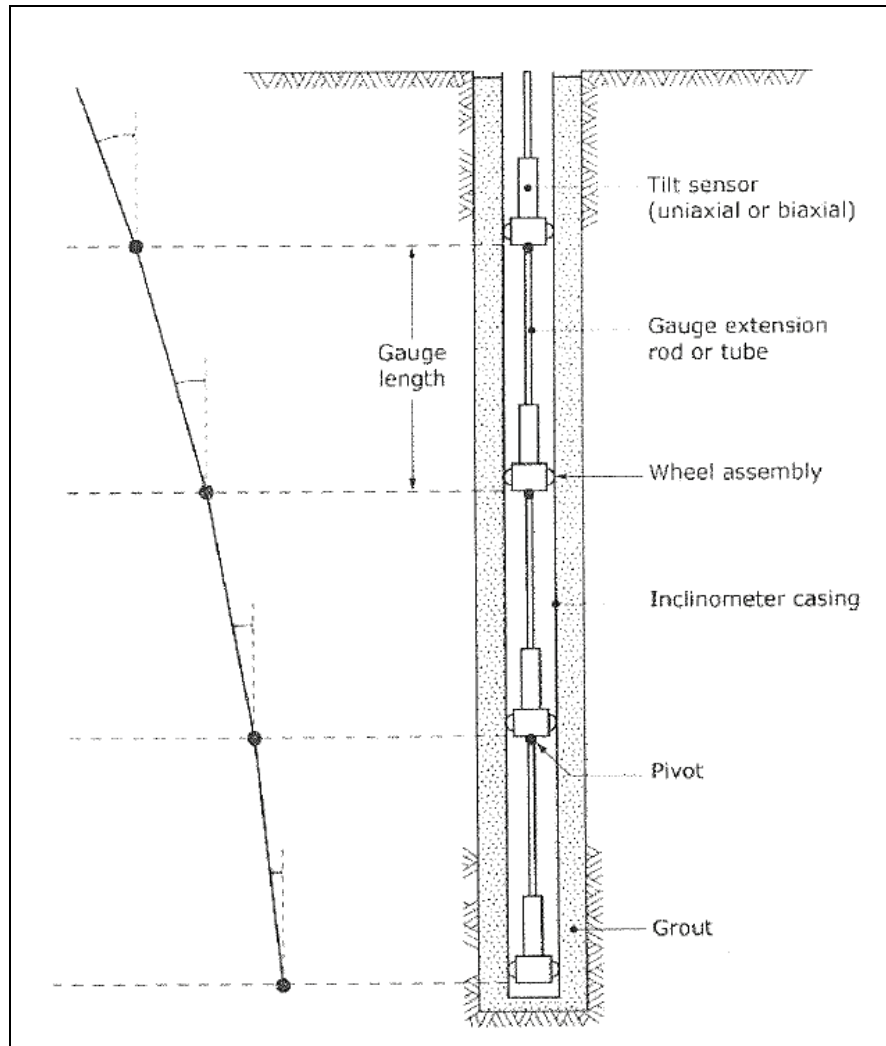
Advances in instrumentation and communications electronics over the past 20 years have permitted the development of in-place inclinometers that can be controlled and monitored remotely. In-place inclinometers model the conventional type inclinometer in terms of quality and accuracy. A schematic of an in-place inclinometer is shown in Figure 5-12. The in-place system consists of a series of rods connected by hinges that run along the entire depth of the borehole. Mutually perpendicularly oriented tiltmeters are located at the top of each rod for the purpose of measuring the vertical deviation angle at each depth.

Figure 5-11. Presentation of incremental and cumulative displacement plots for inclinometer data (DGSi 2011).



The in-place inclinometer offers several advantages over the conventional inclinometer. If desired, readings can be obtained remotely at regularly scheduled time intervals and saved in a data logger located on the ground surface. There is no need to have a technician come to the site and take measurements, thereby resulting in a cost savings. Additionally, it is possible to wirelessly transmit the collected data back to the office for data processing and interpretation in real-time.

Figure 5-12. Layout for in-place inclinometer (ICE 2012).

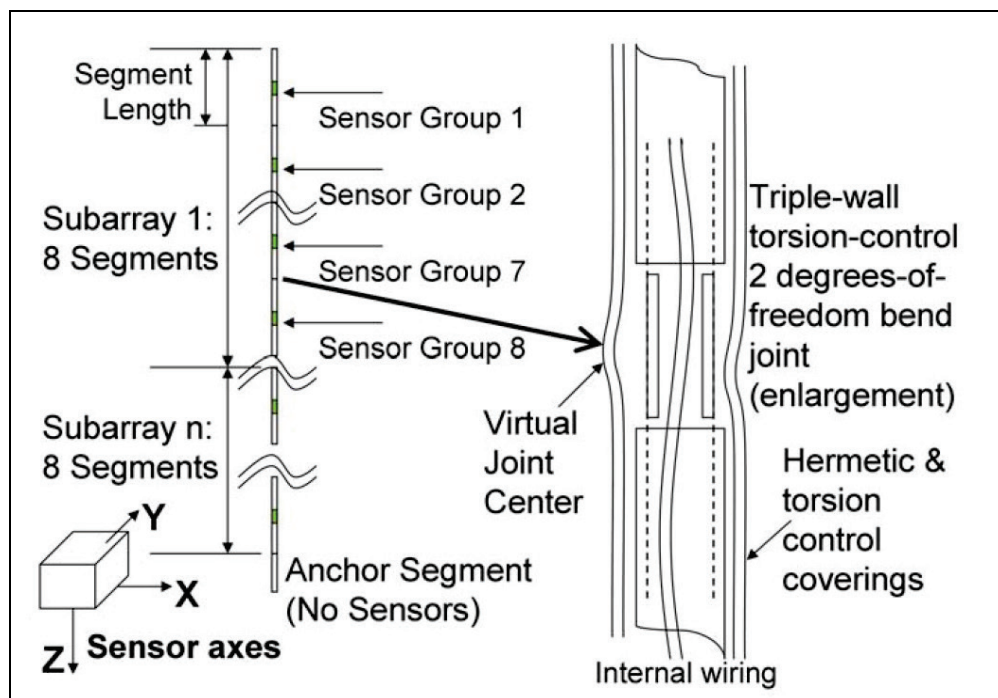


ICE (2012) points out that the in-place inclinometer system can be used in conjunction with a conventional inclinometer. The idea being that the in-place system can be initially installed and remotely monitored to identify any potential horizontal displacements in the ground. Should ground movements occur, the in-place system can be removed and follow-up measurements can be performed manually with the conventional inclinometer. Conversely, the conventional inclinometer measurements can be performed initially to determine the occurrence of horizontal ground movements. If movements occur, an in-place inclinometer system can be installed in the borehole and subsequently monitored remotely. Additionally, an alarm system can be tied to the remotely recovered data to trigger when the movements are becoming unacceptable and to signal when further action is required.

5.6.1.3 ShapAccelArray (SAA) inclinometer

A promising new technology involves a ShapAccelArray (SAA) instrumentation system and is described by Abdoun and Bennett (2008). This in-place system uses MEMS technology and consists of a system of 300-mm-long rods connected by flexible composite joints that permit motion in two directions without torsion. A schematic of this system is presented in Figure 5-13. MEMS transducers are fixed to each rod segment (Sellers and Taylor 2008). This type of system eliminates the need for guide casings to control the orientation of the instruments. The system can also be adapted for measuring vertical displacements and deformations in real-time. The development and miniaturization of MEMS technology allowed the development of these instruments at lower costs, as compared to a more traditional accelerometer, and they have become smaller in recent years. MEMS displacement range is ± 15 deg.

Figure 5-13. Schematic of ShapeAccelArray (SAA) in-place inclinometer system (Abdoun and Bennett 2008).



The system is built by connecting subarrays consisting of eight segments end-to-end (Abdoun and Bennet 2008). Data from each subarray are monitored by a microprocessor that collects and transmits the data to the surface through two communications wires. Because only two wires are needed for communications, the system is thin enough to fit into a 1-in (2.54-cm) diameter casing and is flexible enough that it can be rolled onto

a reel for transportation and storage as shown in Figure 5-14. The subarrays are spaced only 1 ft apart from each other.

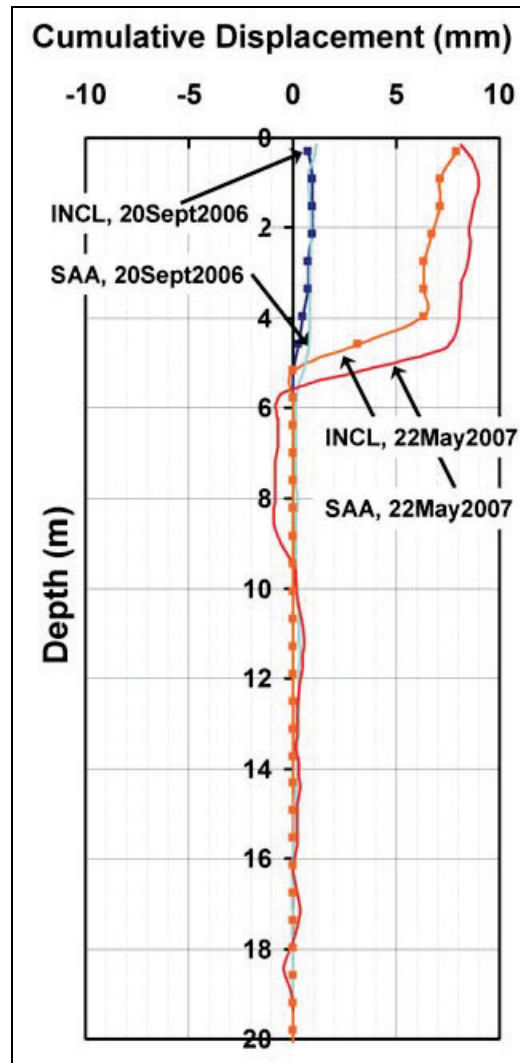
Figure 5-14. SAA on shipping reel (32 mm) (Abdoun and Bennett 2008).



The joints between the subarrays resist torsion and therefore make it unnecessary to use a grooved guide casing to insure the positioning of the instruments. However, special installation techniques are used to secure the instruments in the cased borehole. When the instrument string is lowered into the cased borehole to the depth of interest, there will be a space between the instruments and the casing. Normally, sand is added to fill this space and ensures that the instruments are coupled to the casing so that the measurements will reflect the movements of the ground around the casing.

MEMS sensors in this instrument are accurate to ± 0.6 in/12 in. They are +stable under the temperatures normally encountered beneath the ground surface. The resolution of the tilt angles is between about 3 to 5 arc-sec. Figure 5-15 shows a cumulative displacement plot that compares data obtained from a conventional inclinometer and the SAA in-place type inclinometer in the same cased borehole. These results show that the SAA data compare closely with the data obtained with the conventional inclinometer (Abdoun and Bennett 2008). The SAA system is designed to be retrievable, thereby offsetting the initial costs. Commercial companies are available that offer engineering services for the SAA type inclinometer (Geocomp 2013; Ridley 2013).

Figure 5-15. Comparison of conventional and SAA in-place inclinometer measurements for an unstable slope at a California test site (Abdoun and Bennett 2008).



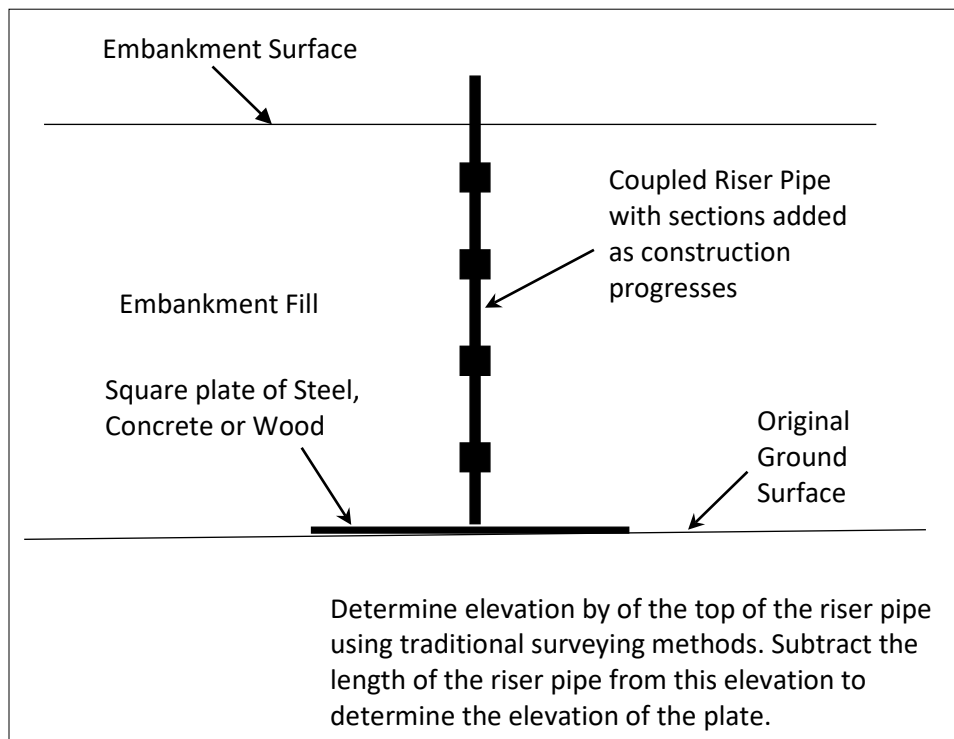
5.6.2 Vertical methods for measuring subsurface deformations

5.6.2.1 Introduction

Vertical measurements need to be made at various times for purposes of determining movements and deformations. Types of vertical measurements in engineering are settlements under loads as a function of time, earthquake-induced settlements, and vertical movements caused by changing moisture contents in clays. A variety of instruments and methods have been developed to make these measurements. These are discussed in this section.

Settlement platforms: Settlement platforms represent one of the simplest methods for measuring vertical deformation. Settlement platforms are often used when an embankment is constructed on soft ground. A schematic of the settlement plate is shown in Figure 5-16. The device basically consists of a square platform (3 or 4 ft square), which rests on the original ground surface (Dunnicliff 1993). At the start of the measuring process, the elevation of the top of the platform should be determined to establish the original elevation of the ground surface before fill is placed. A riser pipe is affixed to the plate, and coupled sections are added as the fill height advances. It is important to keep track of the accumulated length of the riser pipe above the plate as sections of riser pipe are added. Once the earthwork construction is completed, the settlement at any time can easily be determined by measuring the elevation of the top of the riser pipe (using traditional surveying methods) and subtracting the length of the riser pipe to determine the instantaneous elevation of the top of the platform. The amount of settlement of the original ground surface will be the difference between the instantaneous and the original elevations of the platform.

Figure 5-16. Settlement plate schematic (Dunnicliff 1993).



Good practice requires that care must be taken to keep the pipe vertical. Additionally, for embankment heights exceeding about 25 ft, a sleeve should be placed around the riser pipe to provide a gap between the pipe

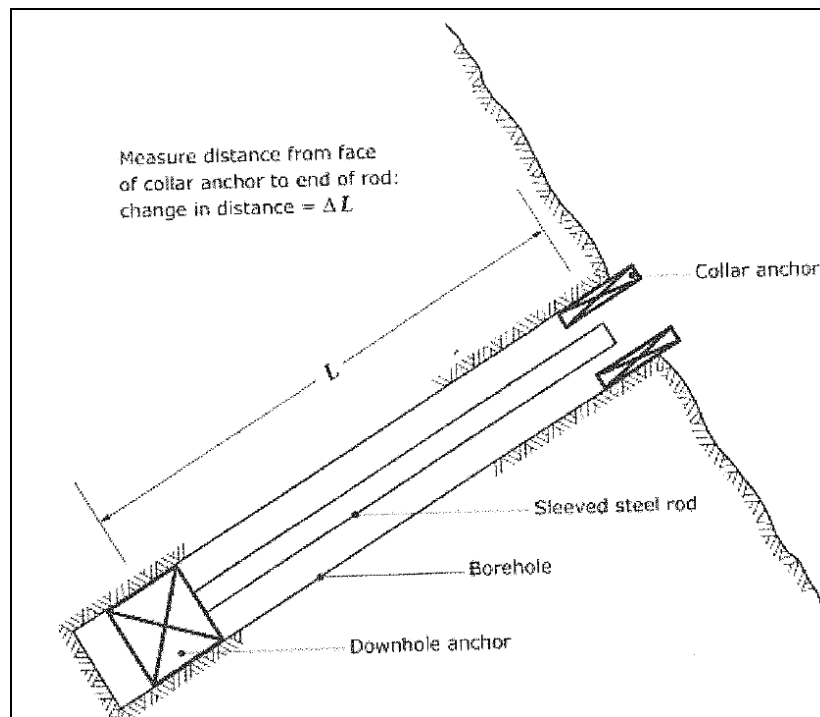
and the sleeve for the purpose of eliminating down-drag forces caused by contact with the fill being transferred to the plate, and thereby causing erroneous readings. Some drawbacks to this method are that settlement platform riser pipes are easily damaged during construction and the riser pipes can interfere with achieving adequate compaction. Some of these disadvantages can be overcome by installing a buried plate (plate without the riser pipe). If an accurate survey of the location of the plate exists, then it is possible to drill a hole down to the top of the plate. Settlement can be estimated by making depth measurements to the top of the plate.

This technique is normally highly manual in nature because the data are collected using traditional survey methods, which require a survey crew. Some automation is possible with total station monitoring to obtain the elevation of the top of the riser pipe.

Extensometers: Extensometers are devices that are used to monitor the changing distance between two or more points along a common line in the subsurface. They are classified as one of two types: probe extensometers and fixed-borehole extensometers (ICE 2012). Typical applications are monitoring behind the faces of excavated slope and around excavations in rock.

Fixed borehole extensometers: ICE (2012) defines fixed-borehole extensometers as devices installed in boreholes drilled in soil or rock for monitoring the changing distances between two or more points along the axis of the borehole. The measurements are made *without* the use of a movable probe. The operating principle behind fixed-borehole extensometers is illustrated in Figure 5-17 for a Single Point Borehole Extensometer (SPBX). Arrangements with multiple anchors in a single borehole are called Multiple Point Borehole Extensometers (MPBX). For the SPBX shown in Figure 5-17 the distance between the face of the collar and the end of the rod is measured either mechanically or with an electric transducer. SPBX use one anchor as shown in Figure 5-17. Additionally, MPBX employ multiple anchors at different locations along the borehole to monitor the movements at different points. This maximum number of anchors for MPBX is controlled by the number of rods that can fit in the borehole. Normally for a 6-in. hole, the number of anchors is eight. It is possible to monitor these devices remotely using wireless communications technology.

Figure 5-17. Operating principle for fixed borehole extensometer (ICE 2012).



Probe Extensometers: Probe extensometers are devices for monitoring the changing distance between two or more points along a common axis by passing a probe through a pipe. A schematic of the setup for a Probe Extensometer is shown in Figure 5-18. The anchors are secured with springs at various depths along the borehole. Each anchor contains a magnet (spider magnet) that provides a magnetic field at each position. The probe contains a reed switch that closes a circuit as it passes these magnetic fields induced by the spider magnets Figure 5-18. The depth at which this switch closure occurs should be noted because this marks the positions of each magnetic anchor at the time of the reading. These positions can change with time. Because the extensometers are secured to the sides of the borehole via the anchors, changes in relative positions (from readings taken at different times) are a reflection of the vertical deformations occurring in the ground between the anchors. An example of data collected from a borehole instrumented with MPBX probe extensometers is presented in Figure 5-19.

Figure 5-18. Schematic of probe transducer that has a magnetic reed switch (ICE 2012).

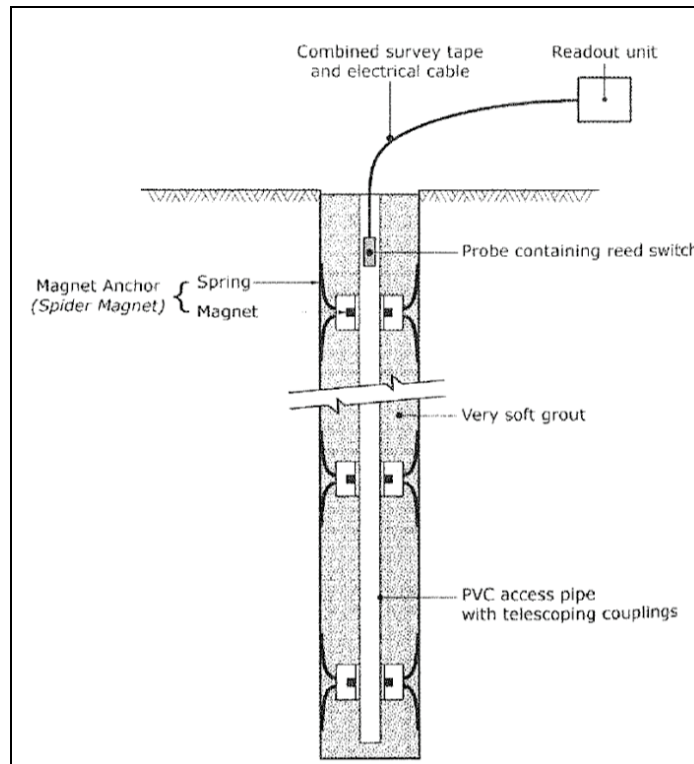
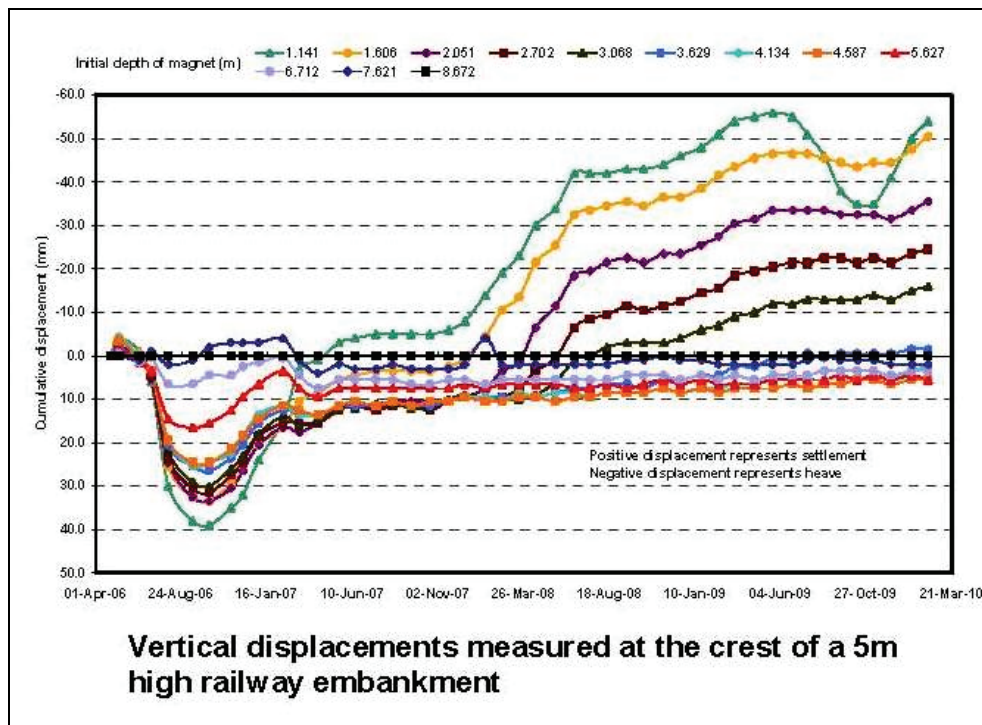


Figure 5-19. Cumulative displacement plot of data collected from probe inclinometer with magnetic reed switch (Ridley 2013).



Inclinometers used for vertical deformations: Inclinometers can be used to monitor vertical deformations as well as the horizontal deformations described in the previous section of this report. Both conventional and SAA type inclinometers can be used to monitor the vertical movements (settlements). This type of monitoring would apply to new construction. A typical application would include the construction of an embankment on soft ground for the purpose of monitoring settlements.

Conventional Inclinometers: At the onset of embankment construction, grooved casing should be installed in a shallow trench excavated at the location where the settlements are to be monitored. The grooves in the casing should be installed in a vertical alignment. The excavation should be backfilled with sand. Figure 5-20 shows the system set up as either an open-ended or closed-ended (dead-end) installation, and the pulley systems and pull-cables required for each type of installation. A pull-cable must be placed in the casing at the time the casing is installed so that the inclinometer can be advanced through the casing and readings can be taken. Figure 5-21 provides details of how the slope indicator is connected to the pull-cable for either the open-ended or closed-ended installation. Figure 5-22 shows a two-pass procedure that is required when the data are collected. For the second pass, the inclinometer probe is reversed from the orientation made during the first pass. The two readings are averaged at each location. Each reading measures the tilt angle from the horizontal direction. Data reduction procedures are illustrated in Figure 5-23. A conventional inclinometer is not used for automatic data collection. Data collected are usually presented as settlement profiles at different times.

SAA type inclinometer: The SAA/MEMS type inclinometer can also be used to monitor settlements. The SAA/MEMS inclinometer has the advantage that they can be set up for in-place and automatic remote monitoring. The New York Department of Transportation (NYDOT) reported that the SAA/MEMS inclinometers do not require a grooved casing, and they are able to tolerate large ground deformations while retaining the ability to still gather data (Barendse 2012). Additionally, the MEMS sensors can be retrieved from severely distorted casings and reused on another project. A picture of the SAA/MEMS sensors are shown in Figure 5-24. The sensors can be laid out as shown in Figure 5-25 for purpose of monitoring settlements in a wick drain field. This figure shows the SAA/MEMS sensors installed in a “snug” fitting 1-in. PVC pipe and buried in a trench that runs transverse beneath the embankment. Data reduction procedures are similar to those for conventional inclinometers.

The data collected are usually presented as settlement profiles at different times.

Figure 5-20. Setups of open end and closed end installations (DGSi 2006).

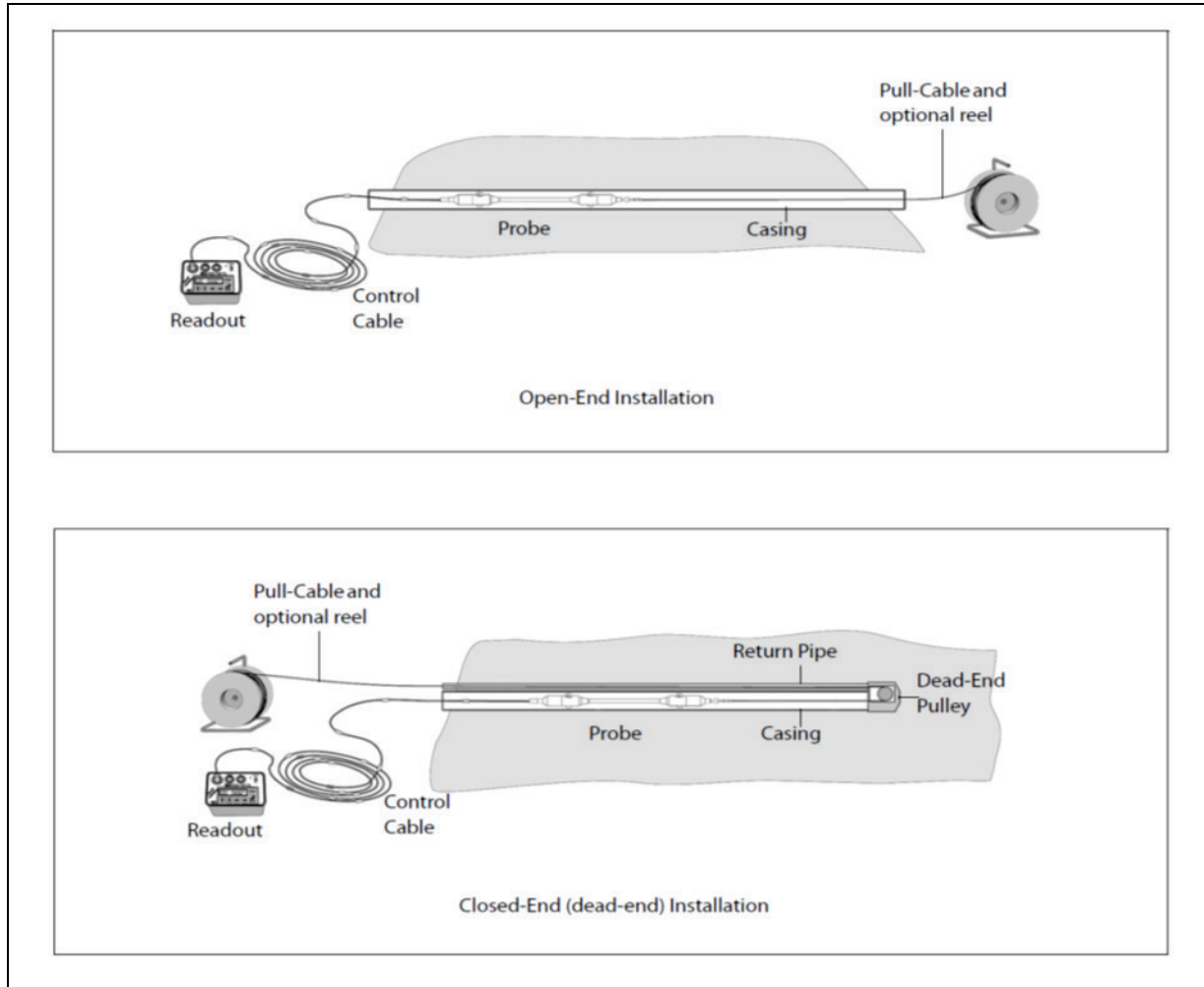


Figure 5-21. Setup for horizontal inclinometer readings. (DGSi 2004).

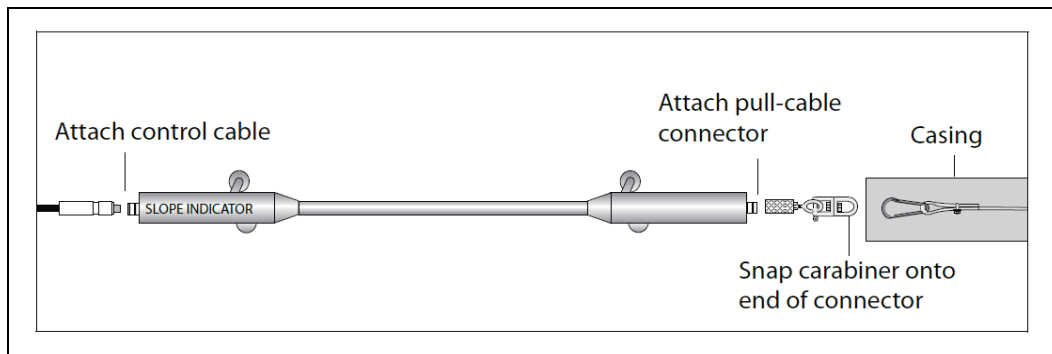


Figure 5-22. Two-pass procedure for taking conventional inclinometer readings (DGSJ 2004).

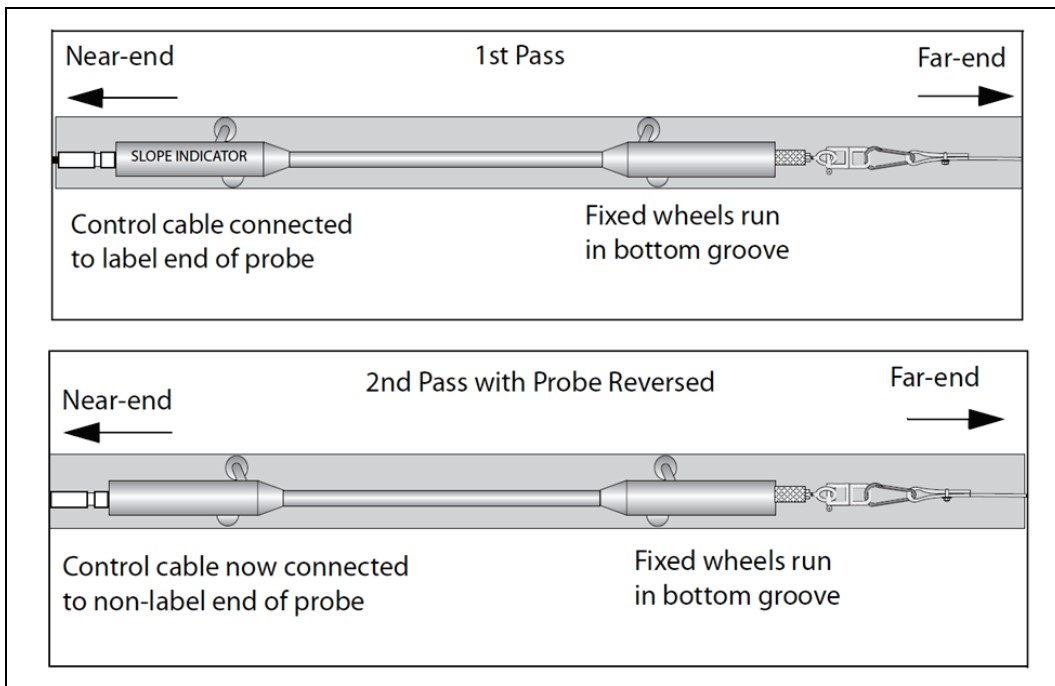


Figure 5-23. Calculation of deviation based on tile angle (DGSJ 2004).

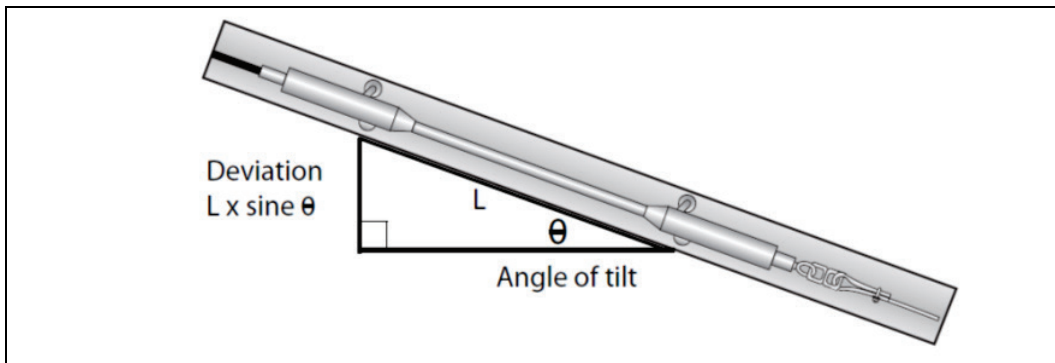


Figure 5-24. SAA/MEMS inclinometer string on shipping wheel (Barendse 2012).



Figure 5-25. SAA/MEMS inclinometer string installation over a wick drain field (Barendse 2012).

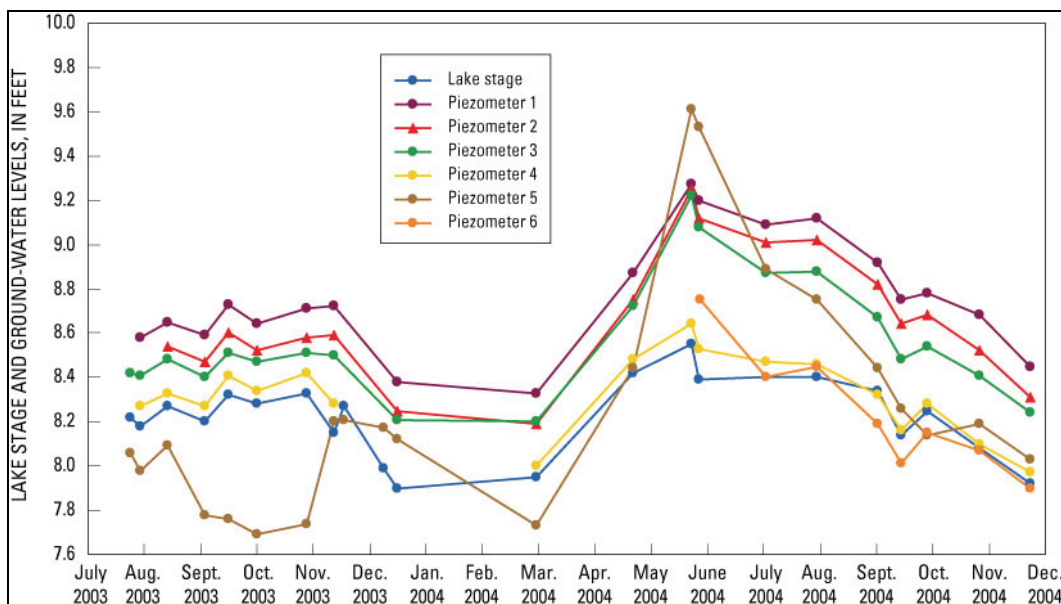


5.6.3 Groundwater pressure and water level measurements

5.6.3.1 Introduction

Measuring groundwater pressures is useful in geotechnical applications because the monitoring of both positive or negative pore water pressures can have a great impact on the soil strength, consolidation, settlement, and uplift pressures (i.e., at the interface between soil layers with contrasting permeabilities and underlying structures) at the site of interest. These pressures can then be compared with water level data to determine pressure and stage correlations as seen in Figure 5-26. Guidance on instrumentation of dams and levees is presented in HQUSACE (1995d). Techniques and sensors not described in USACE (1995) are discussed in greater detail in this section.

Figure 5-26. Piezometric groundwater pressures and water stage readings (Garn et al. 2006).



5.6.3.2 Groundwater pressure measurement methods

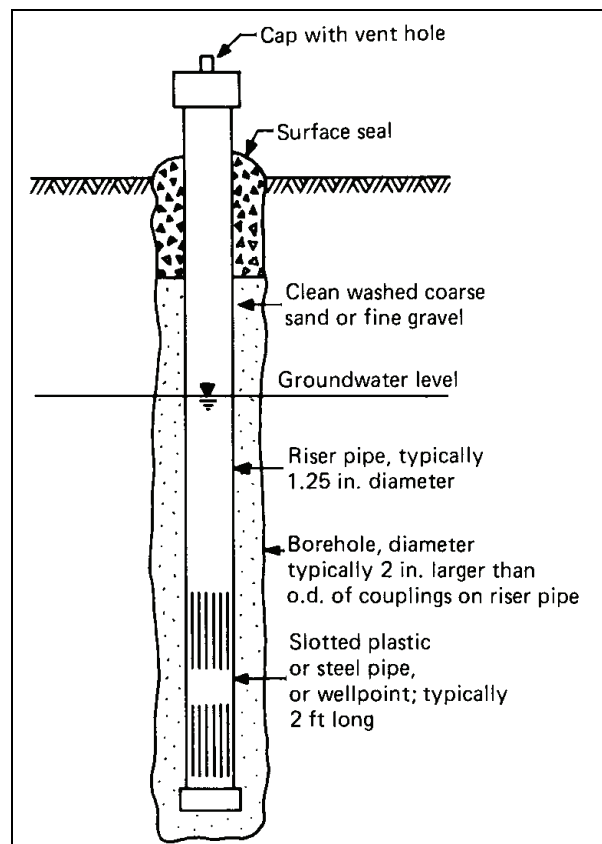
The distinction between a piezometer and an observation well needs to be clarified to avoid confusion. A piezometer is a perforated section of pipe installed in a borehole, or an instrument embedded in the ground that is sealed to allow measurements of groundwater pressures at the specific elevation installed. In contrast, an observation well is a perforated pipe installed in a borehole that is not sealed and creates a vertical connection between different soil layers and elevations, which results in measuring of groundwater pressures through the screened depth. Observation wells are

only valid to measure groundwater pressures in continuously permeable soil through depth (which is difficult to assume); but most often are used to define initial groundwater elevations and seasonal fluctuations (ICE 2012). Piezometers and observation wells involve different techniques and instruments that can be used to measure groundwater pressures.

5.6.3.3 Observation wells

Observation wells are essentially used to determine the location of the groundwater table through use of a perforated section of pipe attached to a riser pipe installed in a borehole (Figure 5-27). These boreholes are filled with sand or gravel and sealed at the surface to prevent surface water from entering into the borehole. Their application is mostly limited to homogeneous permeable soils or, during site investigations, to identify initial groundwater pressures and seasonal fluctuations in static water table conditions (i.e., no seepage underneath the structure). Because unstratified soil conditions are difficult to assume, they are impractical to determine groundwater pressures at specific soil layers of interest due to the hydraulic connection between different soil layers (Dunnicliff 1993; ICE 2012).

Figure 5-27. Observation well schematic (Dunnicliff 1993).



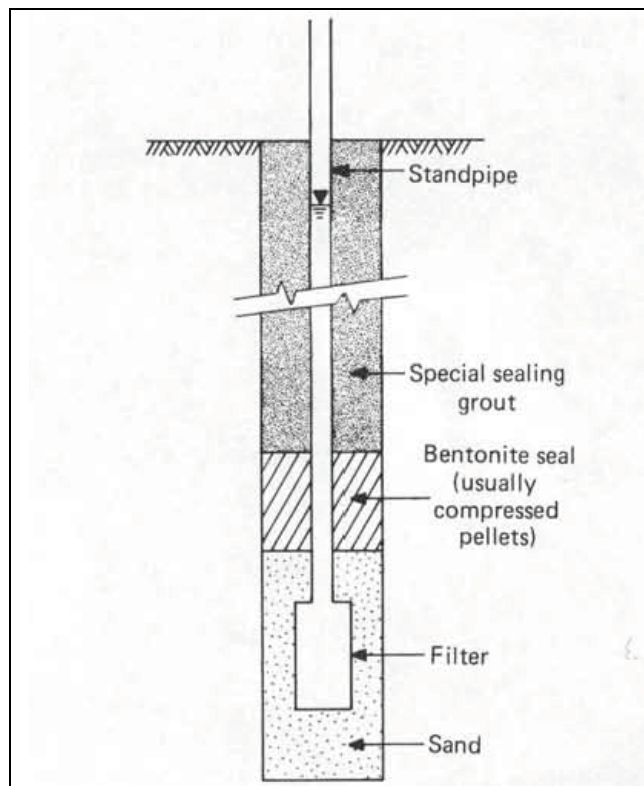
There are different ways to measure the groundwater pressures on observation wells. These include electrical dipmeters (most typical) or sensors such as those described in the Open Standpipe Piezometer section. However, because of their limited application in most cases, they do not ordinarily require remote monitoring capabilities.

- **Electrical dipmeter** (also referred to as water level meter)—These devices are portable hand-operated probes with graduated cable or tape and reel with integrated electronics. They work by lowering the probe down the well until contact with water completes the electrical circuit indicated by a light and a buzzer. The graduated cable or tape used to lower the probe is then read to determine the depth-to-water measurement inside wells and open standpipes. An example of this device is shown in Figure 5-28.
- **Open standpipe piezometer** (also referred to as Casagrande piezometers)—This is a perforated section of pipe attached to a riser pipe installed on a borehole sealed at the surface (same as the observation wells) with the addition of subsurface seals to isolate the strata where groundwater pressures are of interest and avoid groundwater pressures at other layers. These can be installed in fill, inside boreholes, or pushed into the ground (Dunnicliff 1993). An example of the open standpipe piezometer is shown in Figure 5-29. Although they are often used in practice, their main limitation is the hydrodynamic time lag, which causes a slow response to changes in piezometric head due to the necessary water volume required to come in through the slotted section to be able to record a change in pressure. Additionally, the slotted section of the pipe is dependent on the filter material around this section to avoid clogging by fines that may enter into the well. Regardless of these limitations, they are the main standard. Measurements of groundwater pressure can be obtained through use of the electrical dipmeter (previously discussed under the Observation Wells section); and can be remotely monitored through the use of older technology, such as the float-type and bubbler or through the more often used pressure transducer gages discussed next.

Figure 5-28. Water level meter (Scientific Software Group 2013).



Figure 5-29. Open standpipe piezometer schematic (Dunnicliff 1993).



- **Pressure transducers:** Pressure transducers are pressure-measuring instruments consisting of a pressure port, resistors for compensation, and a cable, which is used to measure the water pres-

sure, and convert this value to pressure head using the unit weight of water. Pressure transducers are typically installed below the expected lowest possible water elevation. They are hung in-place and recovered periodically to recalibrate and carry out necessary maintenance. Basic operating principles involve sending an unamplified signal as a result of the applied pressure into a pressure transmitter and converting this signal into the standard output, such as millivolt output, voltage output, or current output. The output signal is then converted to the measurement of interest (e.g., feet of head). The accuracy on these instruments is typically ± 0.1 percent of the specified resolution selected (e.g., sensing resolution can be specified as 0 to 10 ft, meaning the standard output signal range will be calibrated to the specified resolution). Listed below are the different types of transducers for general knowledge on how they operate. However, transducer types are rarely directly specified by manufacturers and are only generally labeled (e.g., “pressure transducers,” “pressure level sensors”).

- **Piezoelectric transducer:** This type of transducer is used to quickly measure alternating pressures (Figure 5-30). Their operation is based on the potential of certain crystals and ceramic materials to produce electrical pulses when stressed mechanically. The electric charge provided by the transducer is analogous to the change in pressure. These are typically employed to measure rapidly changing pressures (Freeman et al. 2004).
- **Capacitive transducer:** In this transducer, two fixed metal plates are located between a diaphragm (Figure 5-31) or to either side of the diaphragm. The diaphragm’s deflection changes the capacitance, which can be determined by an alternating current (AC) across the plates (Freeman et al. 2004).
- **Inductive and reluctance transducer:** Displacements of a diaphragm developed by changes in pressure cause either a change in self-inductance, through relative motion of a single coil for inductive transducers; or magnetic coupling, through external AC excitation between a pair of coils for reluctance transducers. These motions are in turn translated into an electric output signal to obtain the desired pressure head measurements (Freeman et al. 2004). An example of this device is shown in Figure 5-32.

Figure 5-30. Piezoelectric transducer (Freeman et al. 2004).

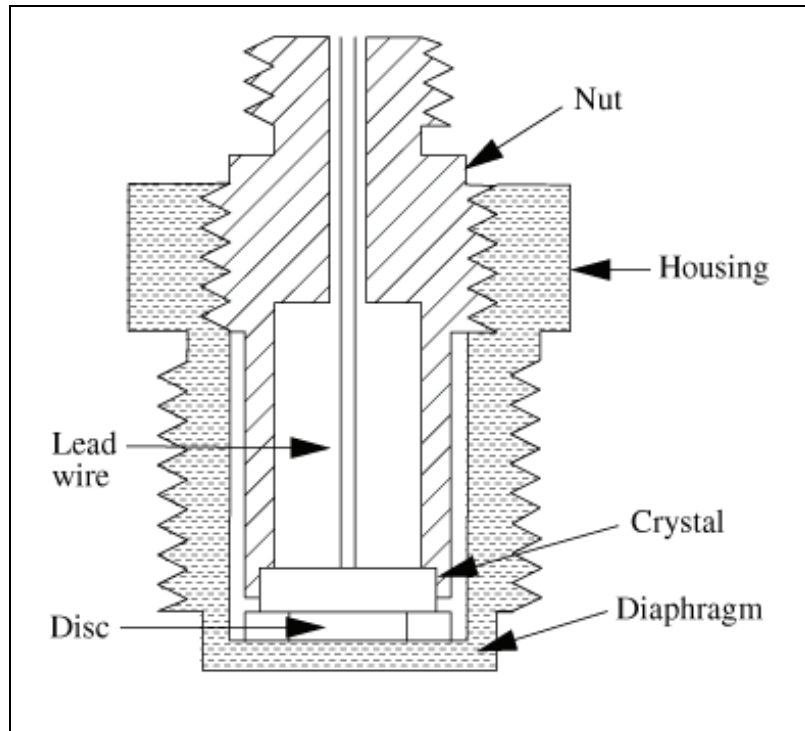


Figure 5-31. Capacitive transducer (Freeman et al. 2004).

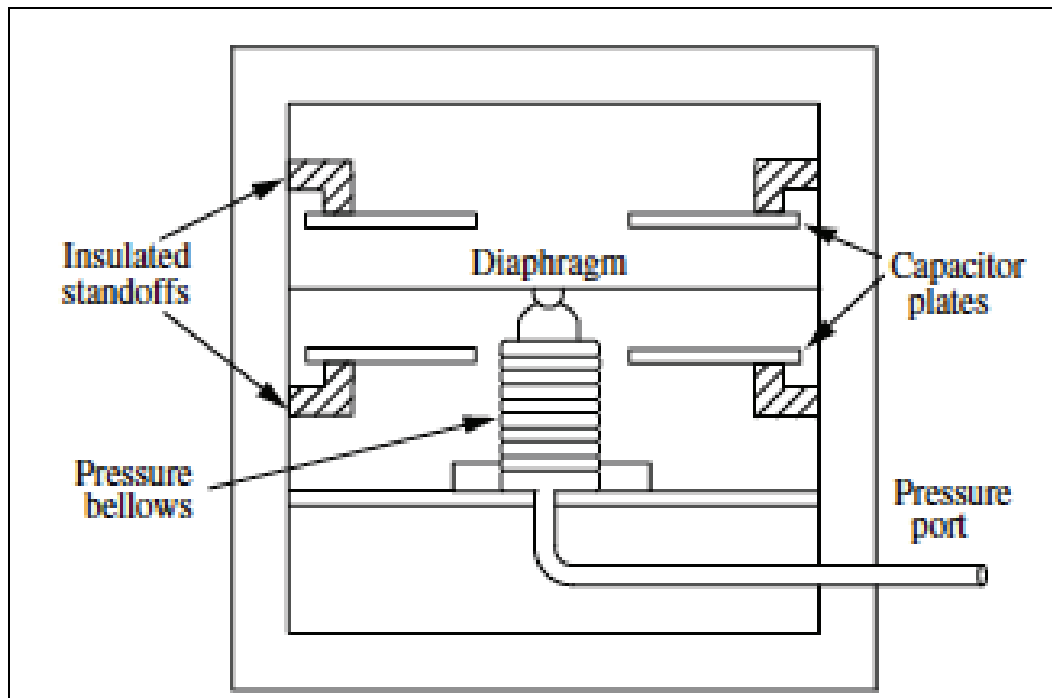
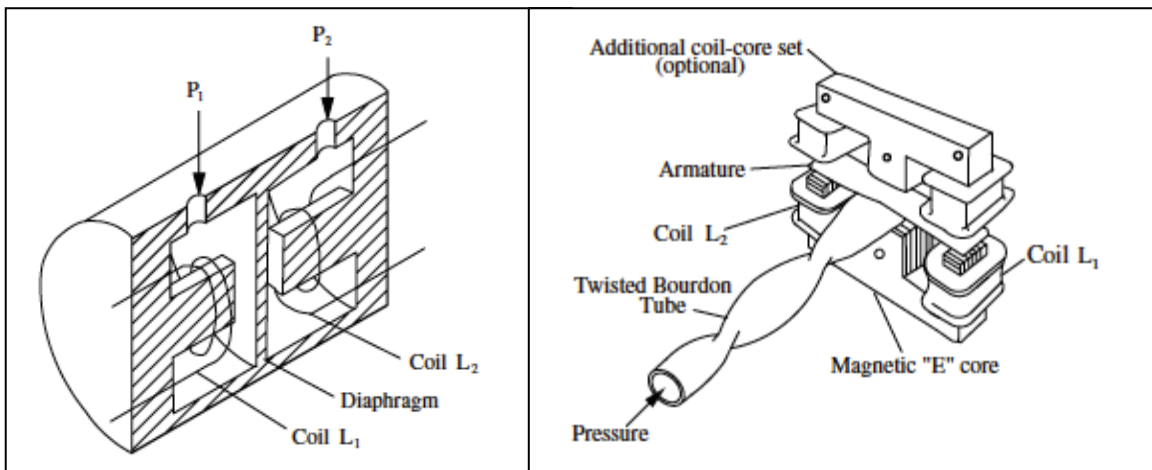


Figure 5-32. Inductive transducer shown on the left, relative transducer shown on the right (Freeman et al. 2004).



- **Potentiometric transducer:** This type of transducer consists of a wiper (or movable contact) traveling across a resistive element (e.g., wire-wound coil, carbon ribbon, or deposited conductive film) as shown in Figure 5-33. The change in motion of the movable contact using either AC or direct current (DC) leads to a change in resistance that produces an electric signal proportional to its displacement (Freeman et al. 2004).
- **Vibrating-wire transducer:** This transducer device uses a vibrating element (wire or cylinder) that completes the circuit for a Wheatstone bridge (Figure 5-34). The vibrating element, located in a magnetic field with one end attached to a diaphragm, moves inside the magnetic field and produces a current when movement occurs. The voltage that results carries the oscillations at the element's resonating frequency, which is controlled by the tension on the wire or cylinder by a diaphragm. Advantages are their small diameter and small signal degradation when long wires are required (Freeman et al. 2004).
- **Strain-Gage Transducer:** The most widely used pressure transducer is the strain-gage type. Basic operation involves the principle that the wire's electrical resistance is proportional to its length induced by strain. Two types of strain-gage transducers exist: unbonded and bonded. They are shown in Figure 5-35.

Figure 5-33. Potentiometric transducer (Freeman et al. 2004).

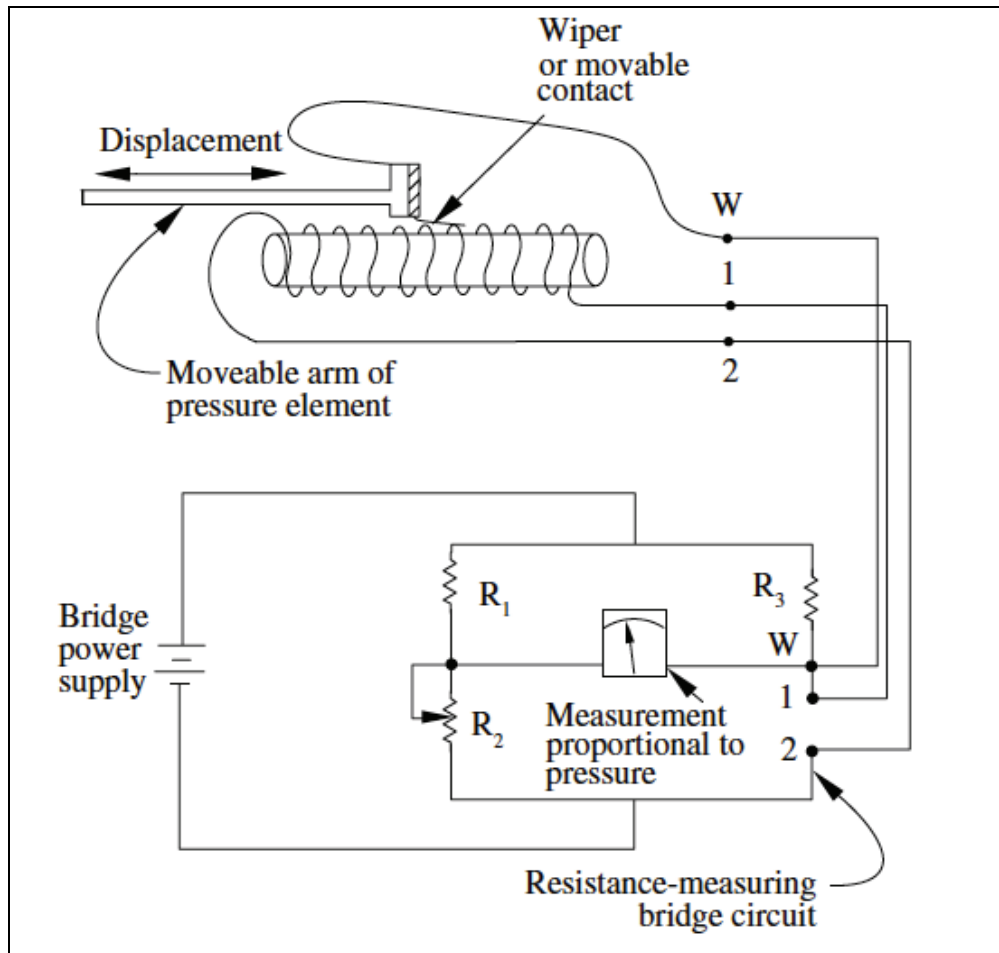


Figure 5-34. Vibrating wire transducer (Freeman et al. 2004).

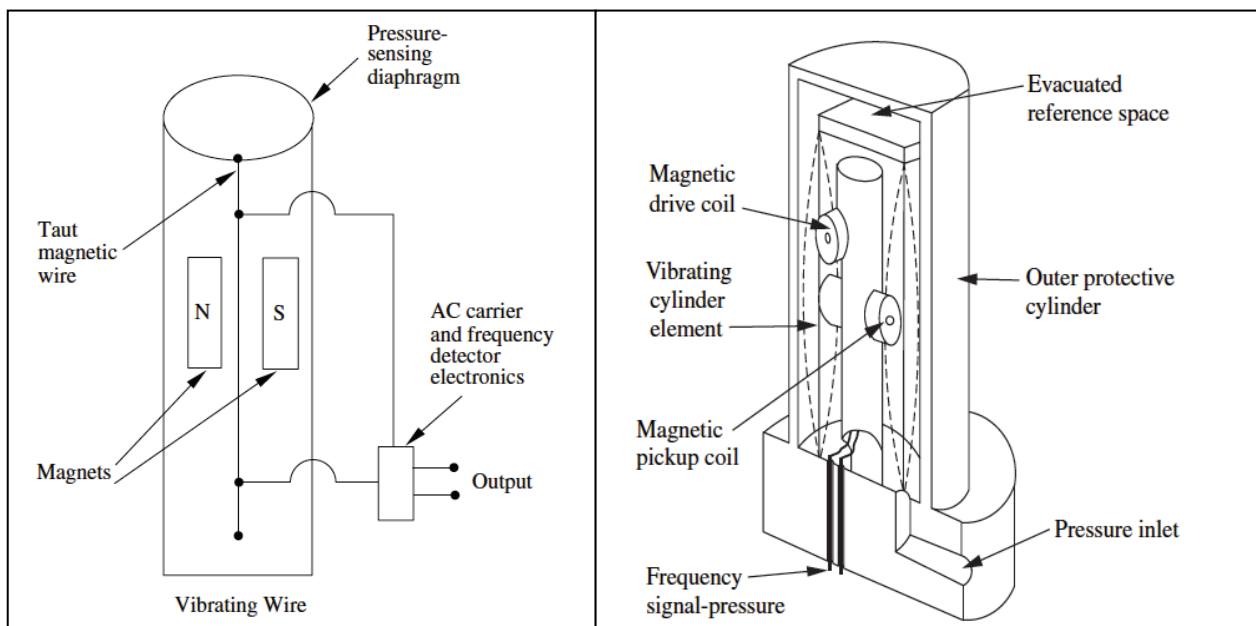
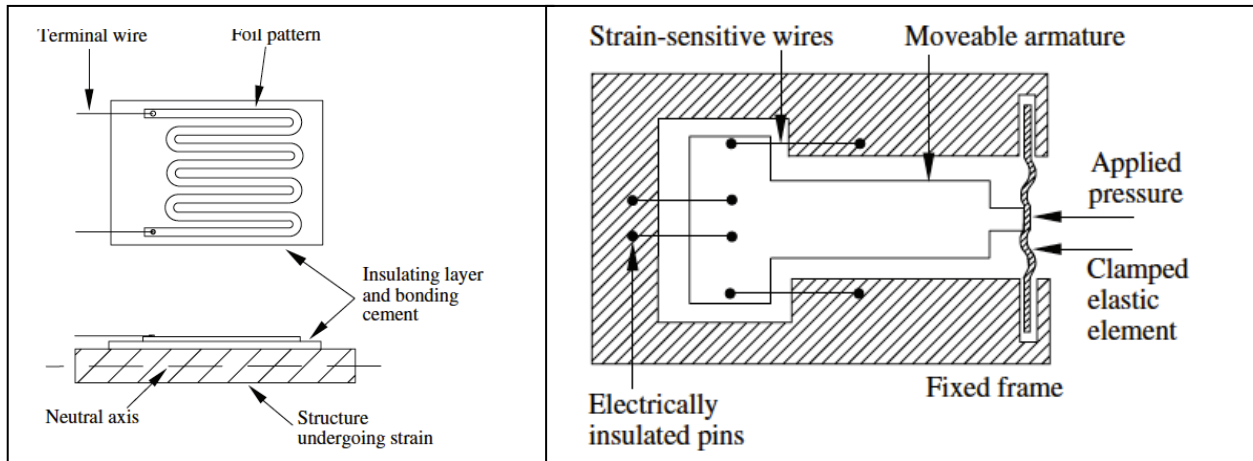


Figure 5-35. Bonded (left) and unbonded (right) (Freeman et al. 2004).



- Unbonded strain gages consist of one or more fixed end strain-sensitive wires and the other end connected to a movable element. When the element is displaced, strain is produced on the wire, resulting in resistance changes proportional to displacement.

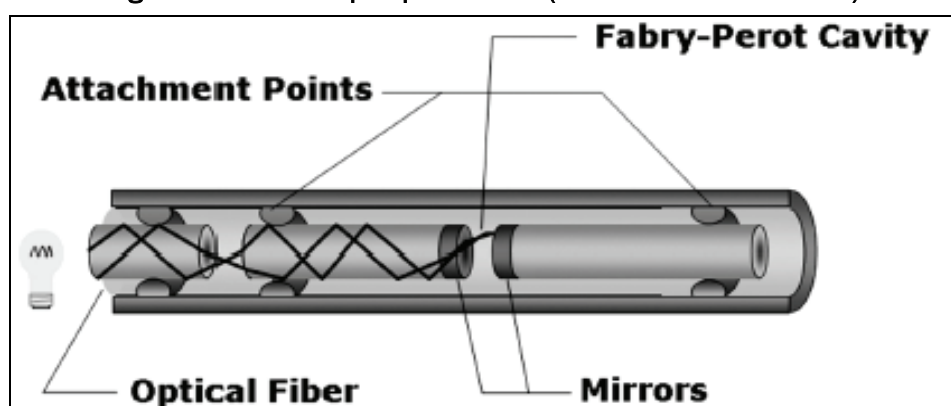
Bonded strain gages are more complex. They are subdivided into those that need an adhesive to bond the gage to the pressure-sensing element (metal foil and strain-sensitive wires) and are mounted on a secondary sensing element and those bonded to make the strain gage an integral part of the strain-sensing element (thin film and semiconductor) and are mounted directly into the pressure-sensing element.

The most common bridge configuration for these transducers is the Wheatstone bridge, excited through a constant voltage or current. The bridge is attached to a diaphragm or substrate. Any changes in pressure distort the membrane and cause the resistance to change proportionally to the strain (Freeman et al. 2004).

- **Fiber optic piezometers:** Fiber optic piezometers are recent developments based on Fabry-Pérot interferometry point sensors and have a single point of measurement at the end of the fiber optic connection cable (Figure 5-36). They consist of a capillary glass tube with two partially mirrored optical fibers facing each other and having an air cavity of a few microns between them. When light is coupled into one of the fibers, a back-reflected interference signal is

obtained (due to the reflection of the incoming light on the two mirrors), which is converted into pressure. Reported advantages of these sensors, compared to other conventional sensors, are the increased measurement precision, long-term stability, durability, and potential to perform remote measurements over long distances involving tens of kilometers (ICE 2012; Inaudi and Gilsic 2007a). A more in-depth discussion of fiber optic technology, including additional information on Fabry-Perot piezometers, is presented at the end of this section.

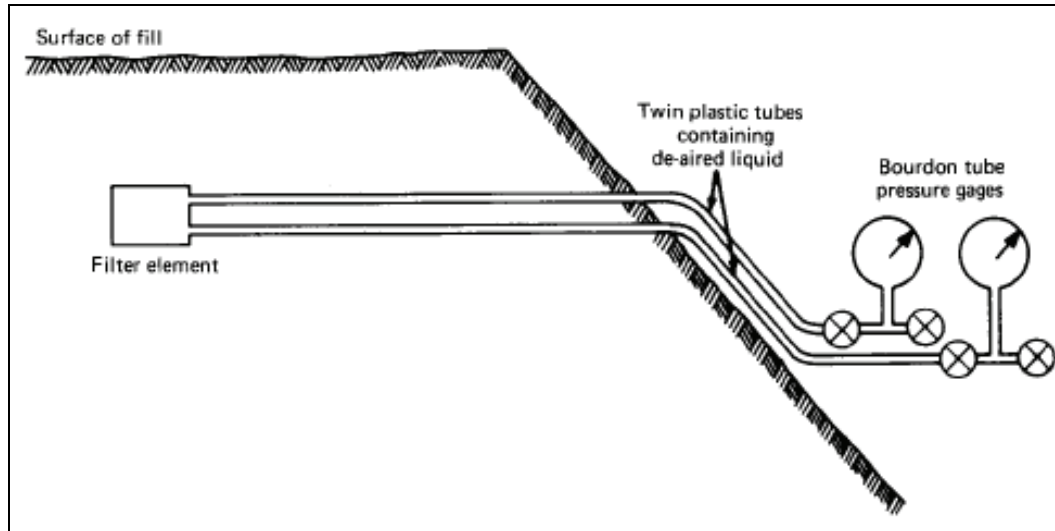
Figure 5-36. Fiber optic piezometer (Inaudi and Gilsic 2007a).



- **Twin-tube hydraulic piezometer:** This device consists of a porous filter element connected to two flexible plastic tubes (extending nearly horizontal in the foundation or embankment soils) filled with liquid (typically water). The two tubes are used to allow the system to be flushed with water in order to remove trapped air and keep the liquid free of gas to maximize the range of pore pressures (i.e., positive or negative) that can be recorded. The piezometric elevation is determined from the average pressure head readings measured using a Bourdon tube pressure gage, U-tube manometer, or pressure transducer for remote monitoring at the end of each tube. These piezometers are more specifically designed for long-term monitoring of pore water pressures in embankment dams. Their main advantages include reliability, ability to measure permeability, and history of performance. However, their main limitations are the horizontal configuration (as they were intended to be installed during construction), which does not allow them to be installed in boreholes, and the high cost of automation. Two transducers need to be installed and data from each has to be logged in order to get pressure measurements (Dunncliff 1993;

Consentino et al. 2002; ICE 2012). An example of a twin-tube hydraulic piezometer is shown in Figure 5-37.

Figure 5-37. Twin-tube hydraulic piezometer schematic (Dunnicliff 1993).



- **Flushable piezometers:** Flushable piezometers are typically used in clay embankments and excavations. Flushable piezometers were designed so trapped air could be removed where negative pore pressure conditions can trap air and incorrectly record pore water pressures. A schematic for this type piezometer is shown in Figure 5-38. Twin-tube hydraulic piezometers can also be flushed for the same reason. These types of piezometers allow for a vertical configuration through the use of a hydraulically-operated shuttle valve to isolate the sensor from the tubes that are used for flushing the system. This design enables this system to be installed in bore-holes typically about 70 mm in diameter, using the fully grouted installation method discussed later in this section (ICE 2012).
- **Pneumatic piezometer:** A pneumatic piezometer consists of a porous filter connected to two tubes containing flexible diaphragms attached to the transducer body. One of the tubes is connected to a pressure gage and a gas supply at the surface as shown by Figure 5-39. There are two ways to obtain pressure measurements with this system, either by the use of the normally-closed method, or by the normally-open method. For the normally-closed method, gas is supplied until it exceeds the pore water pressure acting on the diaphragm, which deflects the diaphragm and allows the air to vent to the atmosphere through the outlet tube. The gas supply valve is closed, and the pore water pressure and internal pressure equalize,

allowing the diaphragm to close and return to the original position. The resulting excess pressure is recorded on a Bourdon tube or an electric pressure gage. This value is taken as the water pressure. Alternatively, the normally-open method supplies gas constantly to maintain a constant flow through the tubes, and the pressure required to maintain the flow is taken as the pressure exerted by the water. However, it has been reported by Dunicliff (1988) that the normally-closed method is preferred over the normally-open method, primarily due to problems caused by large displacements on the diaphragm. The main advantages include the easy access for calibration and non-frost susceptibility. Disadvantages include the response to atmospheric pressures for large borehole diameters (4 in. (100 mm) or larger), potential error created due to difficulty controlling the rate of gas supply, and inability to be remotely monitored, because measurements cannot be data-logged (Dunicliff 1993; Consentino et al. 2002; FERC 2010; ICE 2012).

Figure 5-38. Flushable piezometer schematic (Dunicliff 2012).

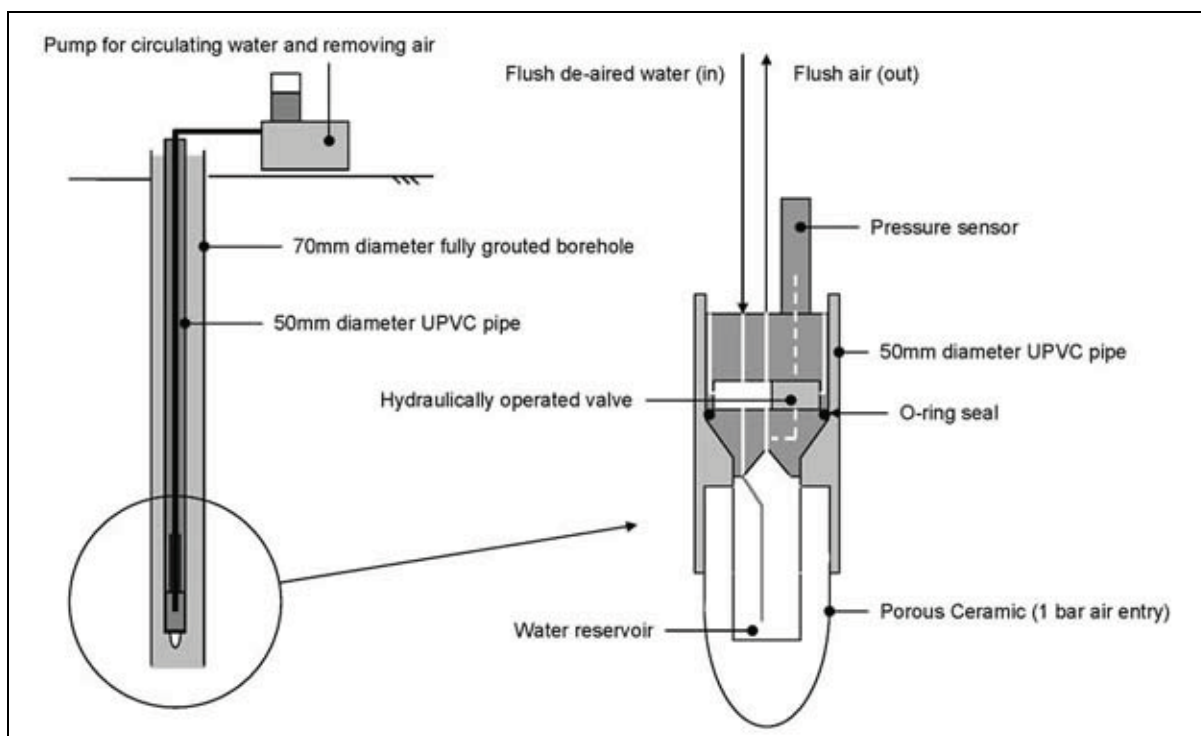
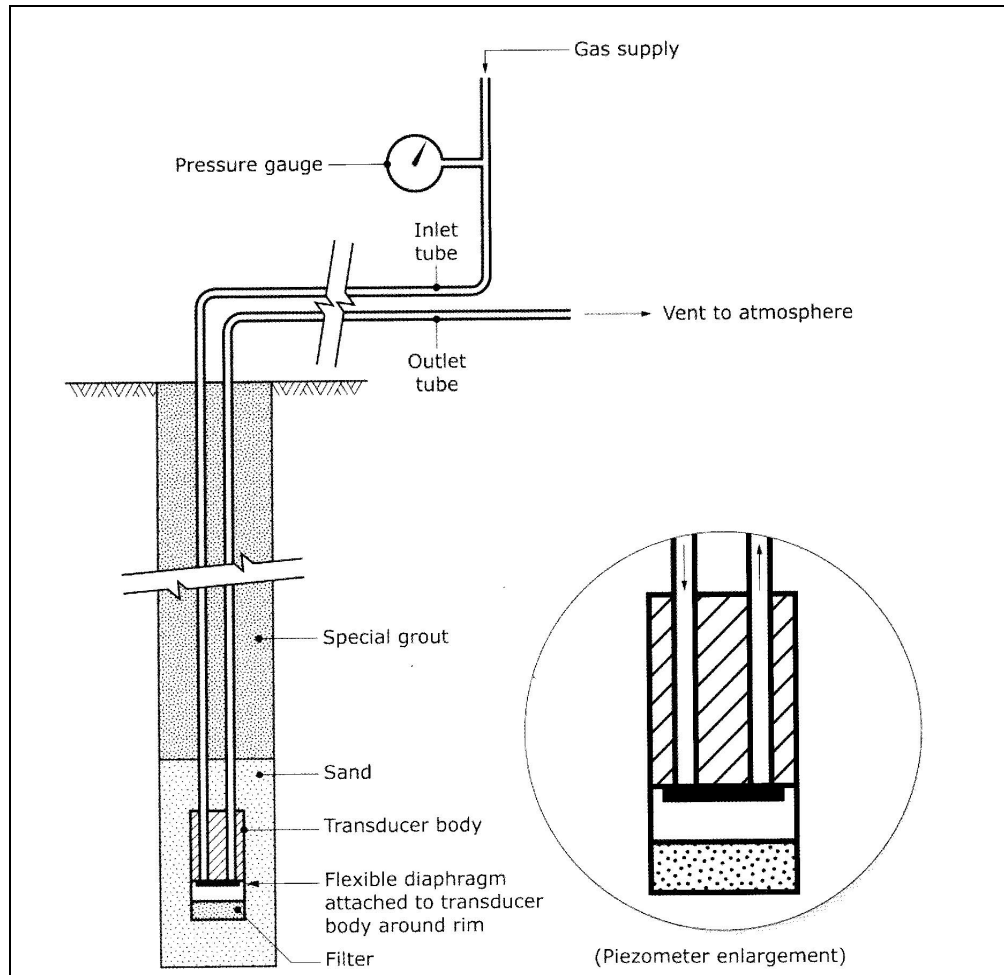


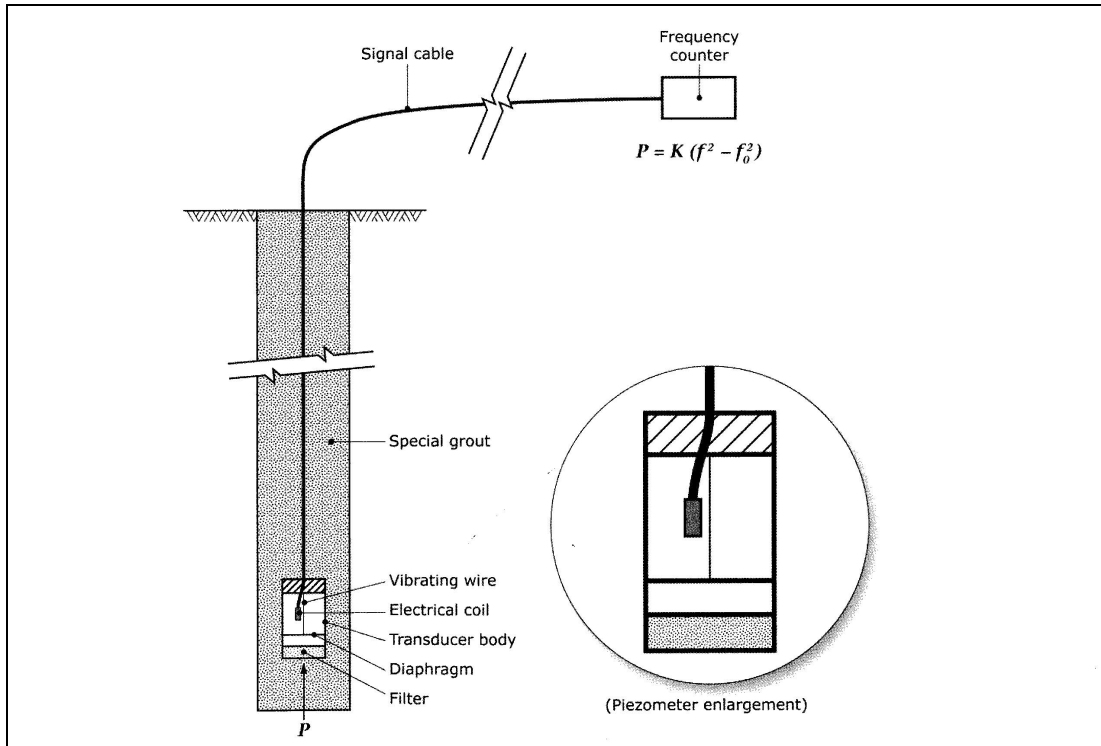
Figure 5-39. Pneumatic piezometer schematic (Dunnicliff 1993, 2012).



- **Vibrating wire piezometer:** This type of piezometer follows the same concepts discussed in the vibrating wire pressure transducers under the Open Standpipe Piezometers section (Section 5.6.3.3). They consist of a porous filter connected to a metallic diaphragm. A tensioned wire is attached so that the diaphragm deflection from the water pressure changes the tension and resonant frequency of the wire (Figure 5-40). The pressure can be measured by calibrating frequency to water pressure and electronically vibrating the wire. Differences between the natural and induced frequencies of the wire will yield the pressure measurements. Disadvantages that have to be accounted for include the zero drift error potential, corrosion of the vibrating wire, susceptibility to lightning strikes, and total stress effect acting on the piezometer body (Dunnicliff 1993). However, their main advantages are the quick response (i.e., short time lag), minimum construction interference (due to ease of installation),

ability to measure negative pore pressures, and no freeze-related issues (Consentino et al. 2002; FERC 2010; Dunnicliff 2012).

Figure 5-40. Vibrating wire piezometer schematic (Dunnicliff 1993; 2012).

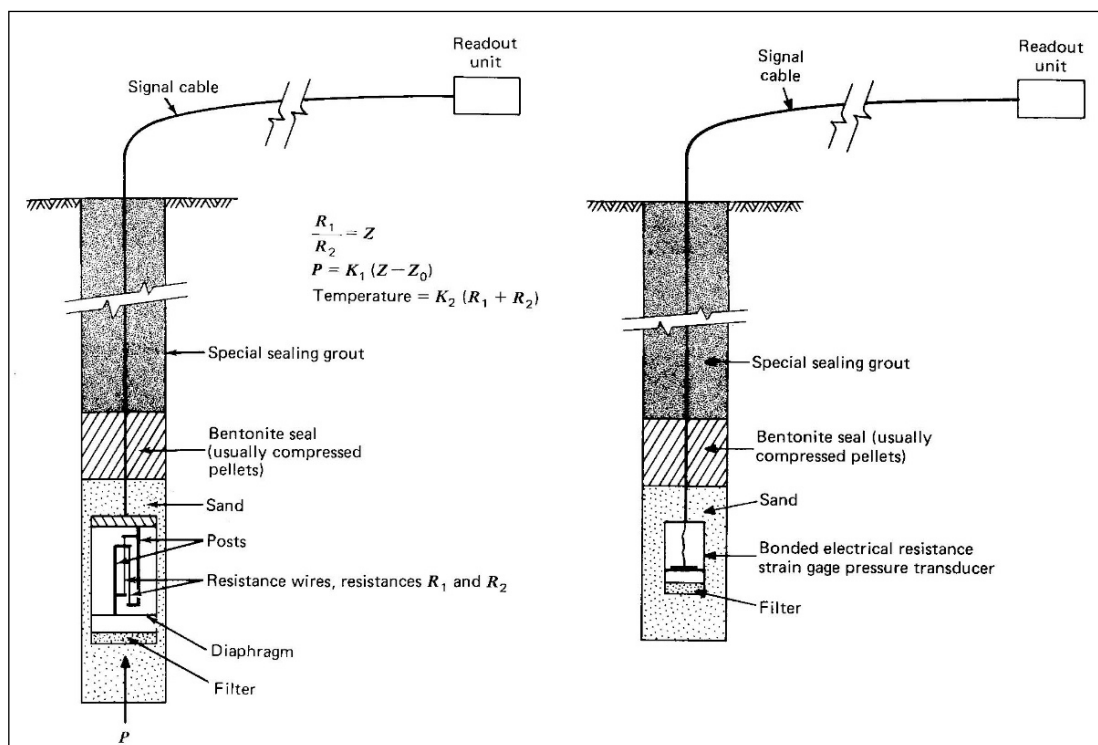


- **Electrical resistance piezometer:** This type of piezometer follows the same concepts discussed in the strain-gage transducers under the Open Standpipe Piezometer section. They are divided into two types—unbonded and bonded. Their basic operation is based on the principle that the electric resistance of the wire is directly proportional to the wire length induced by strain. Figure 5-41 presents a schematic of a bonded and unbonded strain gage setup. The most common bridge configuration for these transducers is the Wheatstone bridge. The bridge is attached to a diaphragm or substrate. Pressure changes distort the diaphragm and substrate and cause the resistance to change proportionally to the strain.

The main advantages for both types are the ease of use. They are the most commonly used type because of short time lag, non-interference with construction, ability to measure negative pore pressures, and unsusceptible to freezing. However, the unbonded type offers the additional advantages of being able to measure temperature and having a lower cost. Major disadvantages include the

presence of moisture in the electronics, which will affect measurements and susceptibility to lightning strikes (Dunnicliff 1993; Consentino et al. 2002).

Figure 5-41. On the left, is an unbonded electrical resistance strain gage schematic. On the right, is a bonded electrical resistance strain gage schematic (Dunnicliff 1993).



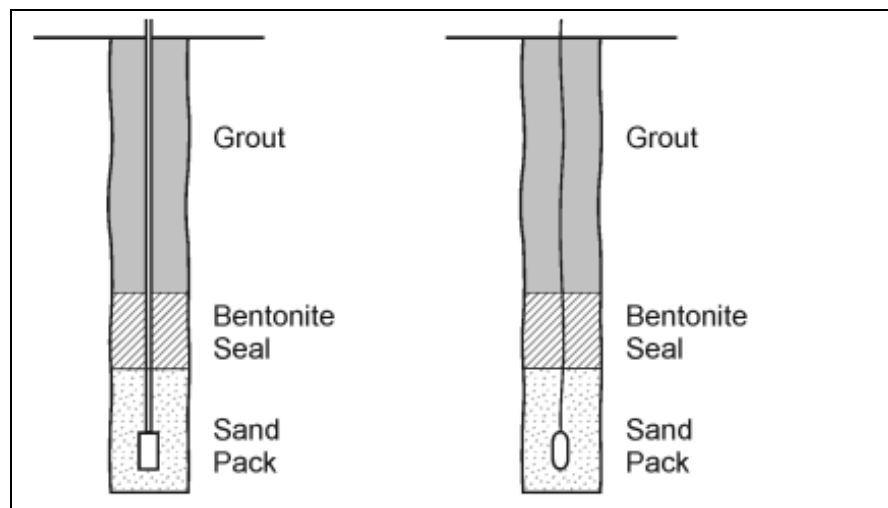
5.6.4 Groundwater pressure system installation techniques

Traditional methods of installing piezometers, such as the open standpipe piezometer, or the diaphragm piezometers (e.g., vibrating wire, pneumatic, and electrical resistance), typically involves placing a filter (referred to as sand pack) around the measurement device, applying a bentonite seal above the sand pack, and grouting the borehole with a cement-bentonite mixture to the ground surface (Figure 5-42). This method has been preferred in practice, mainly due to its long history of performance and familiarity with the technique. However, diaphragm piezometers installed this way can result in incorrect measurements. The fully-grouted method or the push-in method is easier, simpler, less expensive, and more reliable.

5.6.4.1 Fully-grouted method (also known as grouted-in method)

This technique has been available for some time, but recently has gained popularity (Mikkelsen and Green 2003; Contreras et al. 2012). This method only applies to diaphragm piezometers (i.e., pressure sensors embedded on the ground) because only a small volume of water is required to activate the diaphragm on the sensors (Figure 5-43). This technique involves grouting the sensor into a borehole using a low permeability cement-bentonite grout mixture.

Figure 5-42. Conventional open standpipe piezometer installation shown on the left. Conventional diaphragm piezometer installation shown on the right (Contreras et al. 2007).



The radial pressure gradients at the piezometer are typically one or more orders of magnitude greater than those produced by a sensor at a higher point in the soil column (Figure 5-43). This method allows for a simpler and easier installation, which results in a more reliable and cost-effective installation, while also enabling multiple piezometers within the same borehole without complex configuration. When using this method, the primary consideration should be adequate grout-mixing, the required cement-bentonite grout permeability, and the installation procedures in terms of quality control (Mikkelsen and Green 2003; Contreras et al. 2007; Contreras et al. 2012).

5.6.4.2 Push-in method

Using cone penetrometer test (CPT) equipment, piezometers (either open standpipes or diaphragm) can be driven into soft, cohesive soils and fine-grained sands. Their installation is fairly quick and simple because

standard CPT technology is used with no requirement to backfill around the riser pipe (Figure 5-44). A sand-pack filter is not needed because of their small diameter (typically 1 in. or smaller). Small diameter pressure transducers are required to enable remote monitoring. However, the intake port may get clogged because the traditional open standpipe filter sand (i.e., sand pack) around the intake is not controlled.

Figure 5-43. Fully-grouted borehole (Mikkelsen and Green 2003).

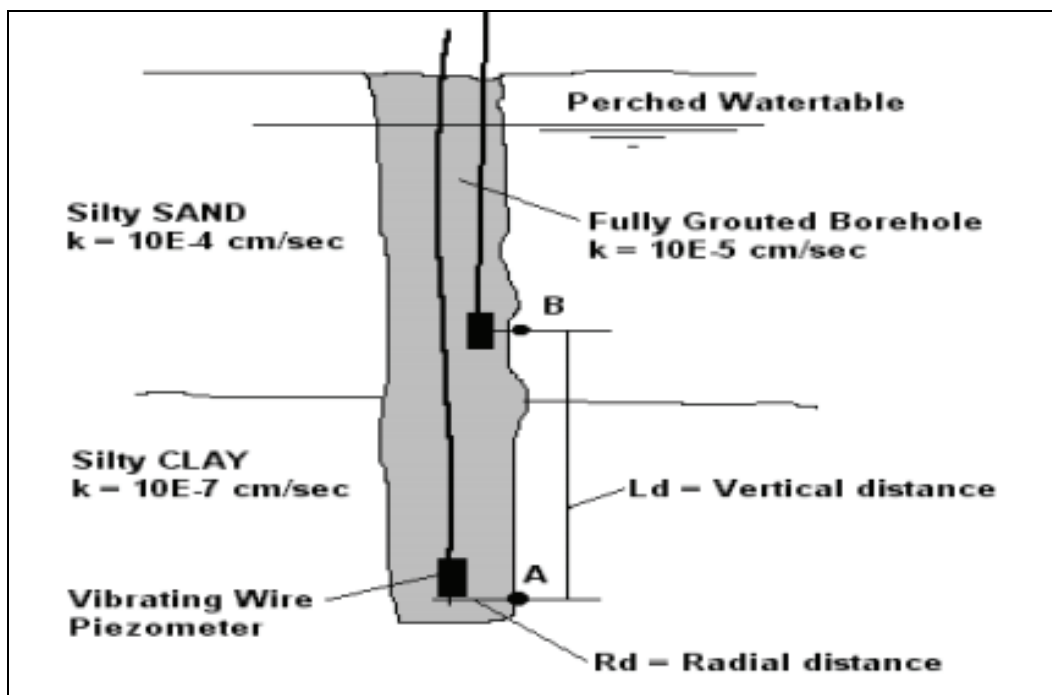


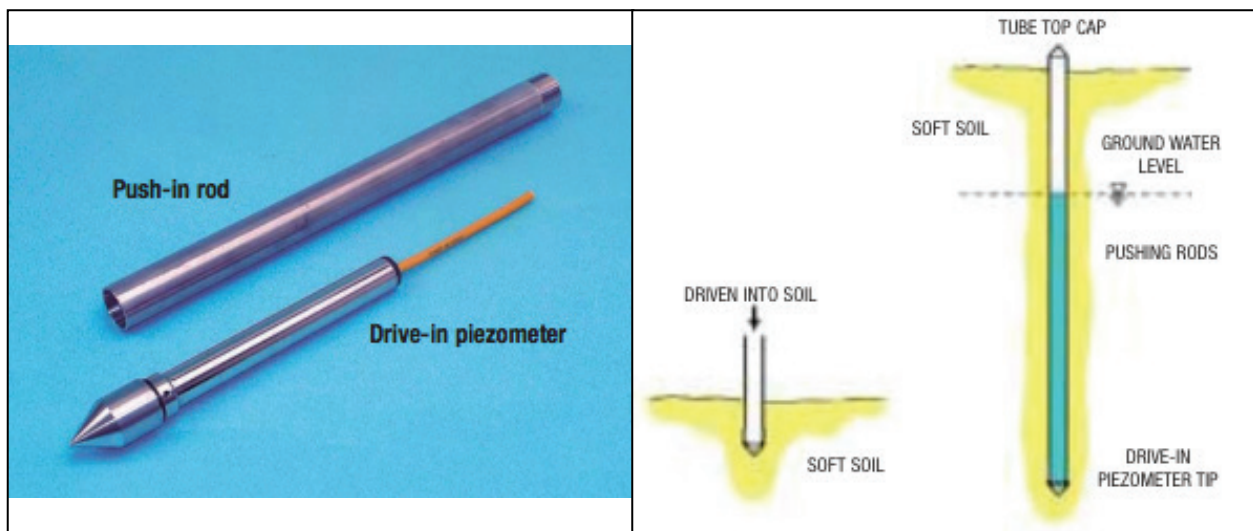
Figure 5-44. Push-in open standpipe piezometer (RST Instruments 2013).



Diaphragm piezometers follow the same concept (Figure 5-45). The main limitations of this method include normal CPT equipment restrictions, soft soil condition, depth (usually limited to shallow applications), down drag consolidation forces exerted, gas generation when dissimilar metals are in contact with the soil and groundwater (leading to incorrect measurements), and possible overpressuring during installation (Dunnicliff 1993).

Because diaphragm piezometers need to be recalibrated and maintenance has to be performed, a removable pore pressure transducer has developed and can be installed using the push-in method. This system is suited for long-term monitoring. The sensor is sealed in a stainless-steel housing in a cone tip to drive through the soil and an inner conical tip having a small opening that allows pore pressure to enter and influence the diaphragm sensor. The installation consists of pushing in a filter unit, piezometric tubing, and then

Figure 5-45. Push-in piezometer shown on left. Schematic of push-in piezometer installation shown on right (Ridley 2013).



lowering an electric cable containing a set of weights and a pressure transducer on the end until it rests on the inner conical tip (Figure 5-46). The transducers can be removed using the electric cable to perform maintenance, or to use at another location. (Dunncliff 1993) This system allows the flexibility of placing pressure transducers in an open standpipe piezometer with the added benefit of using the push-in method for ease of installation and maintenance. The main limitations are similar to those discussed with the push-in method.

5.6.4.3 Water level gages

Water level gages are not technically geotechnical instrumentation but are a central part of the complete system of evaluation in remote monitoring of earthen structures. They are used to measure the head water and tail water stages on dams and river stage on levees. These measurements are then used to compare trends with groundwater

pressures recorded on piezometers located in the embankment. Different sensors are available for this application and are described below.

- **Staff gage:** These gages are used as a visual indicator of water level, but they cannot be used in remote monitoring because they cannot be automated (Figure 5-47).

Figure 5-46. Removable piezometer installation (shown on left figure) and detailed schematic (Ridley 2013).

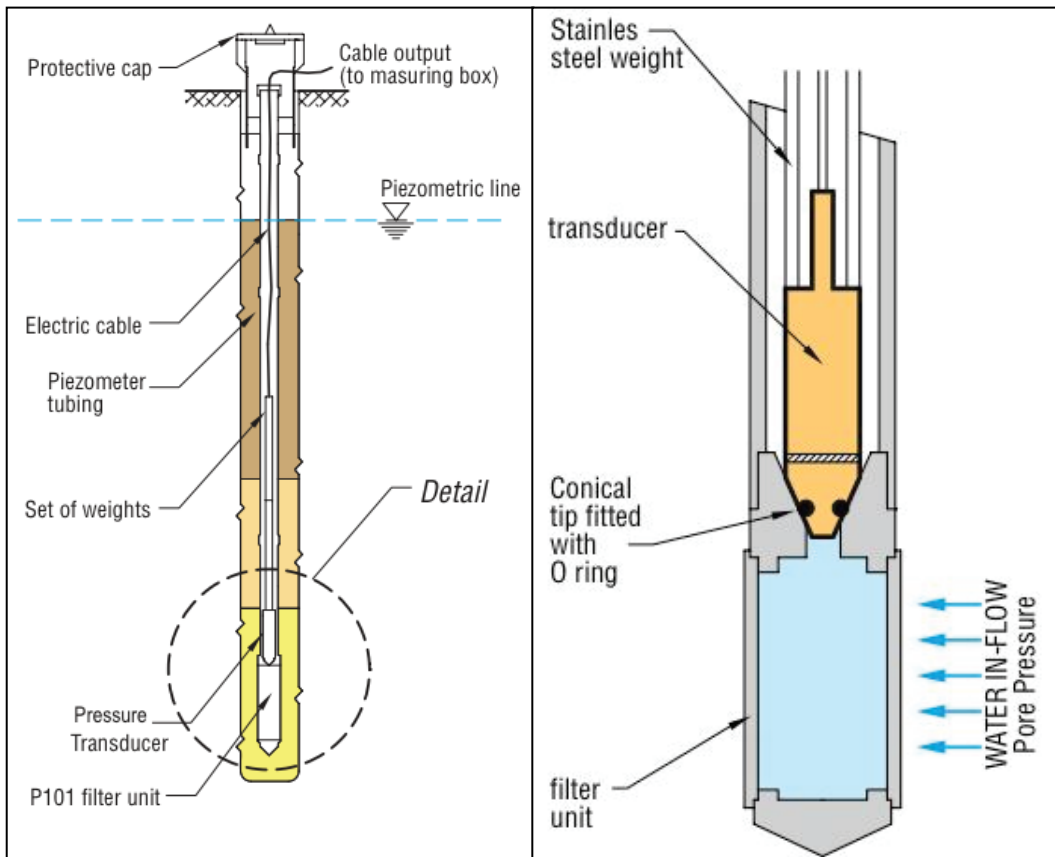
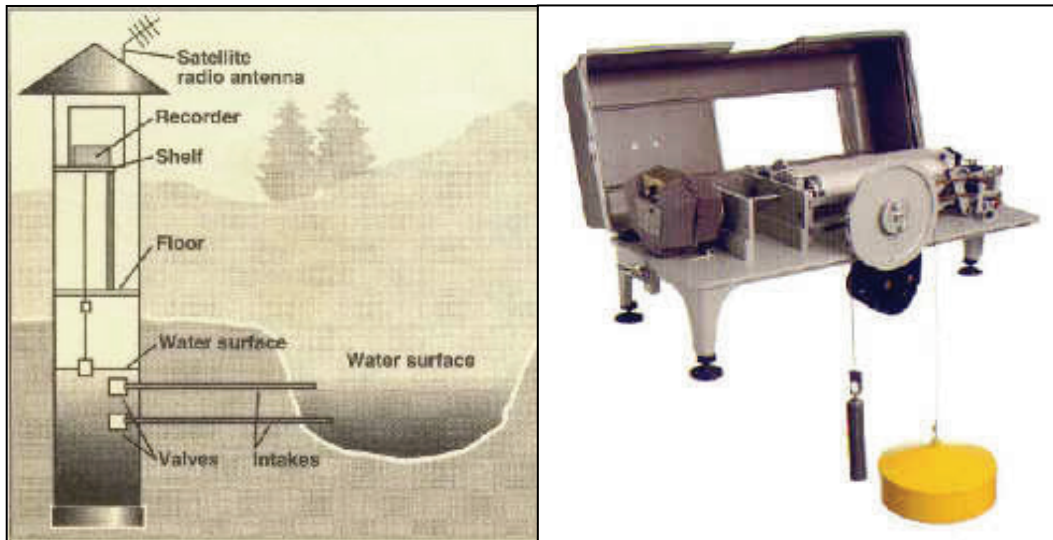


Figure 5-47. Staff gage to measure water levels (USGS 2013).



- **Float-type water level gage:** The gage consists of a pulley connected to a copper or plastic float and a counterweight through stainless steel tape or beaded cable (Figure 5-48). They are usually installed inside stilling wells, which are connected to the stream through pipes. As water levels fluctuate on the stream, the float gage moves inside the stilling well, and the counterweight changes position at the top of the gage where a water level recorder stores water level readings. This type of gage is easily automated for remote monitoring.

Figure 5-48. Stilling well using float gage to record water levels (Wahl et al. 1995). US Type A-71 float gage with water level recorder shown in the right figure (Rickly Hydrological Co. 2013a).



- **Bubbler system:** A bubbler system consists of a pipe (Figure 5-49) and pressure transducer connected to the stream. Gas pressure is applied to the system with nitrogen incorporated into the system design. Changes in water levels produce changes in gas pressure that are detected by the transducer and recorded to a data logger.
- **Ultrasonic or radar stage sensors:** These sensor systems are noncontact with the purpose of measuring the distance to the water surface through air (Figure 5-50). Ultrasonic sensors work by transmitting sound waves, while radar sensors send microwaves. Both systems calculate the distance between the sensor and water surface based on the arrival time of return waves. The precise elevation of the water surface is easily determined by the return distance and can be sent to a remote location. The elevation of the reference station must be surveyed as part of the installation.
- **Submersible Pressure Transducers:** Pressure transducers used to measure groundwater pressures are being increasingly used to monitor water stage elevation because of the ease of installation, maintenance, and versatility (Figure 5-51). However, they are not intended for long-term monitoring.

Figure 5-49. Bubbler system: USGS PS-2 pressure sensor system (Rickly Hydrological Co. 2013b).

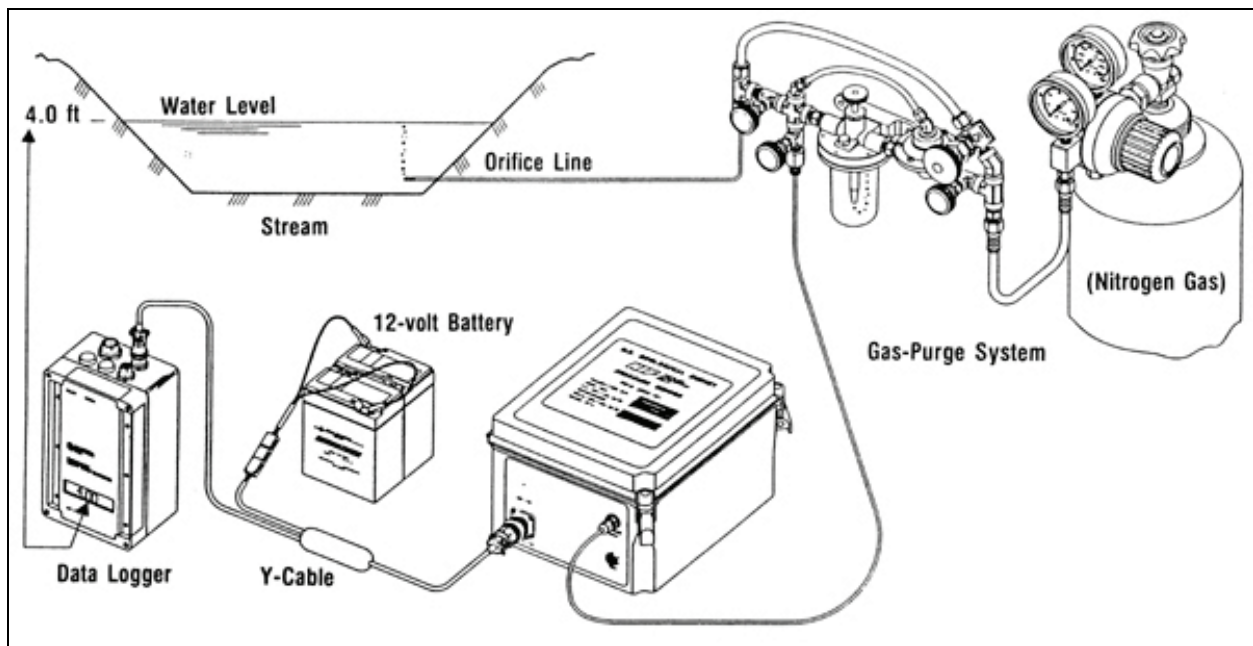
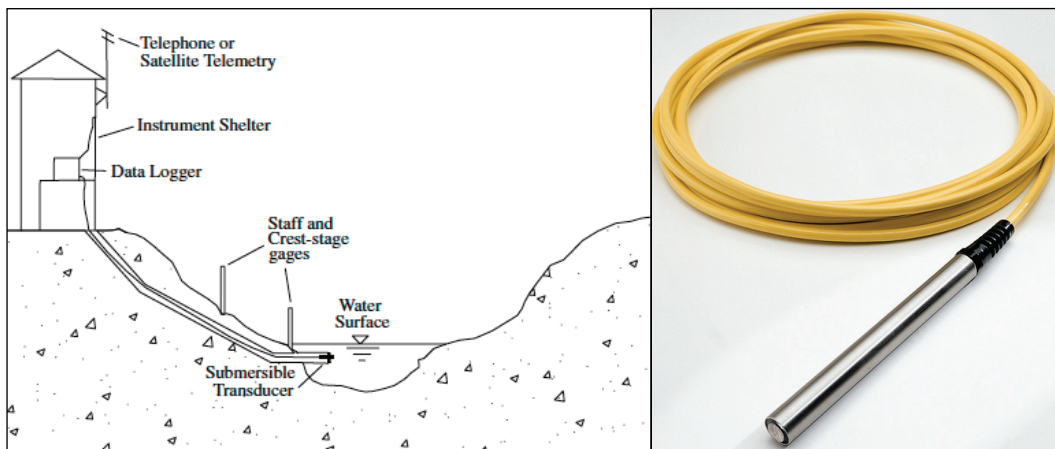


Figure 5-50. Ultrasonic level sensor: EchoSonic II (Flowline 2011).



Figure 5-51. Submersible pressure transducer (Freeman et al. 2004 (left); Global Water 2013 (right)).



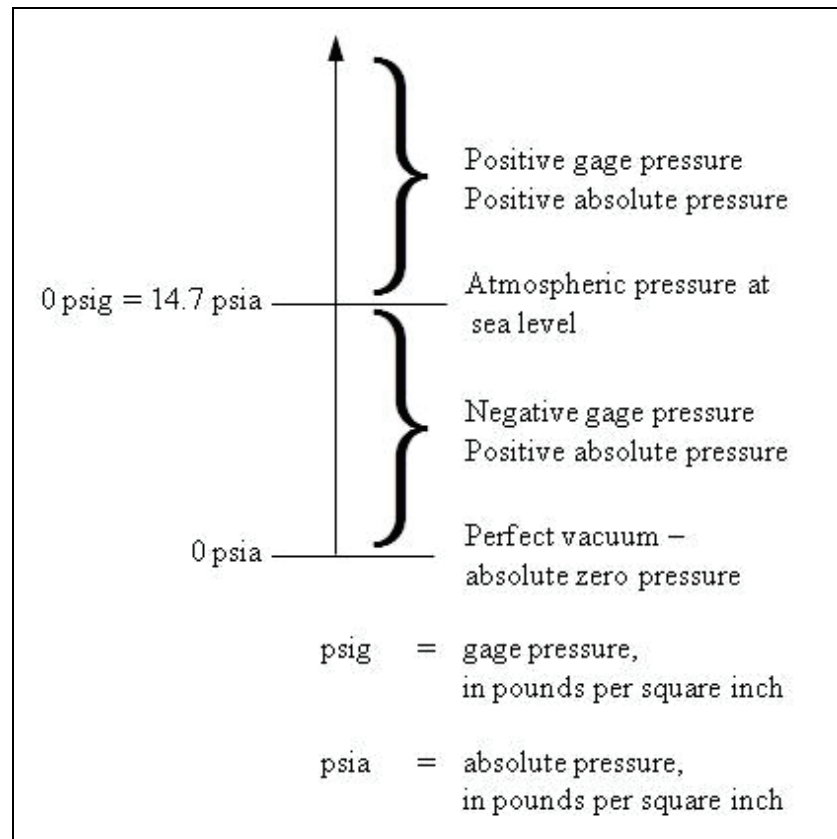
5.6.4.4 Types of pressure measurements

Output from any of the pressure transducers is conventionally defined in PSI (pounds per square inch) and then converted to pressure head (e.g., feet) for engineering purposes. This value is then added to the elevation for the measuring device. All pressure measuring devices have a reference pressure established and a specific PSI type, which can be either expressed as gage pressure (i.e., PSIG), absolute pressure (i.e., PSIA), or as sealed pressure (i.e., PSIS); the most common unit being the PSIG, which references the atmospheric pressure. Different pressure measurements are shown graphically in Figure 5-52.

- PSIG (Gage Pressure):** Pressure measurements are made with reference to a site specific atmospheric pressure by allowing the sensor to be vented to the atmosphere. The venting of atmospheric pressure occurs by a small diameter opening near the electrical termination of the transducer. If the pressure measuring device is exposed to the atmosphere, the zero reading (i.e., 0 PSIG), occurs when both sides of the diaphragm pressure are equal. Positive pressure occurs when the values are greater than the atmospheric pressures and vice versa. Some of these sensors can be sealed to a specific atmospheric pressure to maintain consistency and avoid further maintenance issues. However, possible errors of measurements may be introduced.
- PSIA (Absolute Pressure):** Pressure measurements are made in reference to an absolute vacuum (i.e., absolute zero pressure) and completely sealed at the zero reading (i.e., 0 PSIA). Thus, pressure measurements are always positive. If the pressure measuring device is

exposed to the atmosphere, the reading will be about 14.7 PSIA (i.e., atmospheric pressure). Vacuum pressure occurs on one side and atmospheric pressure on the other side of the diaphragm, for which the net pressure difference will represent the atmospheric pressure.

Figure 5-52. Different types of pressure measurement (Freeman et al. 2004).



- **PSIS (Sealed Pressure):** Pressure measurements are referenced to the dominating pressure sealed within the transducer. Similar to the PSIG, when the pressure transducer is exposed to the reference pressure, the reading will be zero (i.e., 0 PSIS) because on one side of the diaphragm there will be a fixed reference pressure and on the other side ambient atmospheric pressure. Their main limitations are measurements at low pressure levels and temperature-induced internal pressure changes.

5.7 Fiber optic monitoring in geotechnical applications

Fiber optic monitoring is a new technology that is gaining wide acceptance in the geotechnical community for precision monitoring and use in early warning systems. Its origins are tied to the invention of lasers and low-loss

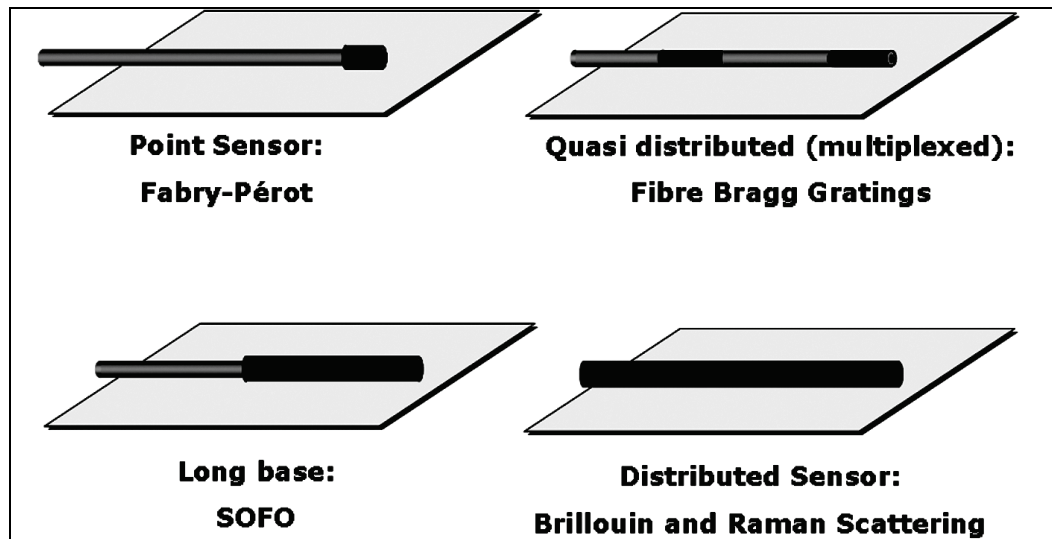
optical fiber during the late 1960s. Continued advances and improvements in fiber optic technology by the telecommunication industry has led to the development of special optical-based sensors for precision monitoring of strain, temperature, pressure, and displacement in geotechnical engineering applications. The physics of these sensors involves accurately measuring changes in light intensity, phase, polarization, wavelength, refractive index, or transmit time of light through the optical cable because of disturbances detected by the fiber. Conventional sensors involving strain, temperature, and pressure are still favored in most cases because of their proven history, better understanding of the technology, and lower cost in terms of single point monitoring applications. However, this sensor technology is becoming more common and has significant advantages over conventional methods. Basic principles of fiber optic sensing technology are described in this section with information derived from numerous sources ICE (2012); Bennett (2008); Inaudi and Glisic (2007a, 2007b); Inaudi et al. (1998, 1999); Johansson and Sjö Dahl (2009); Johansson and Watley (2007); Lee et al. (2012); and Omnisens (2009).

Optical fiber is made of silica (SiO_2) glass or plastic. Silica is transparent on a wide wavelength range, is easily drawn into small fibers, can be easily cleaved and fusion spliced, and has high mechanical strength against pulling and bending, which is further improved with a polymer or metal jacket. Furthermore, it is immune to outside electromagnetic fields, lightning strikes and is capable of operating in fairly rugged environments (Omnisens 2009). The transparent glass core provides the transmission pathway through which the light travels. Cladding surrounding the core serves as a wave guide, which confines the light to the core. The cladding has a lower refractive index than the core to prevent light leakage and creates the wave guide. Doping of the glass with germanium oxide or boron is typically used to increase the efficiency of the refractive index of the core glass (Lee et al. 2012). Similarly, fluorine (F) is used to reduce the refractive index of the cladding (Omnisens 2009). Optical fiber is typically constructed with multiple layers, including a buffer, plastic jacket, or a metallic cable sleeve for heavy-use applications (Figure 5-53). Furthermore, multiple fibers can be run through a single cable for added capability.

Fiber is available in both single mode (single ray of light) or multimode applications (Omnisens 2009). EM radiation in single mode fiber is perpendicular or traverse to the cable length. Multiple propagation paths or traverse modes are characteristic of multimode fiber. Single-mode fiber

has a small diameter core (core to cladding diameter ratio is 9 microns to 125 microns or 9/125 construction) that is designed to carry a single ray of light. The smaller fiber core has significant advantages in terms of its lower dispersion and signal attenuation properties, which results in faster

Figure 5-53. Types of fiber optic sensors (Inaudi and Glisic 2007a).

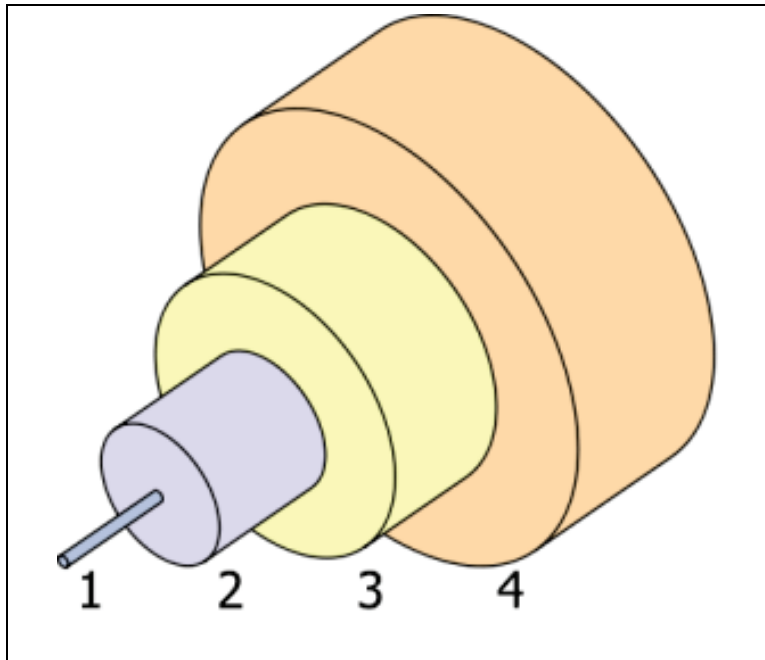


signal speed and longer transmission distance. Single-mode fiber is generally preferred in precision scientific and geotechnical monitoring applications because of its longer signal length, lower attenuation properties, and ability to permit much sharper focus and measurement. Multimode fiber in contrast has a larger diameter core (core to cladding diameter ratio 50 or 62.5 microns to 125 microns or 50/125 or 62.5/125 construction) that permits multiple modes of light to propagate. The larger diameter core allows higher power, more light reflections to occur, and more data to pass at a given time but has higher dispersion and attention properties over longer distances, which reduces the signal quality at long distances. Consequently, multimode fiber is typically used only for short distance applications of less than 1,000 m and typically for communication in a building or in contained campus-type setting. Single-mode fiber has been used mainly for geotechnical monitoring applications because of its long-distance properties and reduced attention characteristics.

Fiber optic sensing for geotechnical applications typically involves four basic kinds of sensors (Figure 5-54). Sensors are classified as being either point-type sensors, multiplexed-type sensors, long-base sensors, or distributed sensors, and correspond to the Fabry-Perot interferometric sensor (Figure 5-34), fiber Bragg grating sensors, SOFO interferometric sensors, and distributed Brillouin scattering and distributed Raman

scattering sensors, respectively (Inaudi and Glisic 2007a). SOFO is the French acronym for Surveillance d'Ouvrages par Fibres Optiques, or surveillance monitoring by optical fibers (Inaudi and Glisic 2007a; Inaudi et al. 1998, 1999). These different sensor types are briefly described here in terms of the basic technology that is used for monitoring applications.

Figure 5-54. Basic components of fiber optic cable are (1) high refractive index glass or plastic core, (2) lower refractive index cladding, (3) buffer, and (4) reinforced jacket (Omnisens 2009).



A fiber optic interferometer uses the interference between two beams that have propagated through different optical paths of a single fiber or two separate fibers. One of the pathways is used as a reference signal, while the other pathway is affected by the property to be measured. Beam splitting and combining of the two signals are necessary to measure the affected property by accurately quantifying the resulting temporal and spectral changes in wavelength, phase, intensity, frequency or bandwidth. Fabry-Perot point interferometric sensors are commonly used for piezometers as described in an earlier section (Figure 5-36), for strain gage applications, and temperature and pressure sensing (Inaudi and Glisic 2007a). An air cavity of a few microns thickness is sandwiched between two partially mirrored optical fibers to create a simple and effective sensor that measures an interference pattern by the reflection of the light that is coupled across the fiber cavity to determine any changes in the fiber spacing by the property being measured.

A recent application by USACE Omaha District involves Fabry-Perot piezometers (described earlier in this report) installed beneath the stilling basin at Gavin's Point Dam on the Missouri River because of potential electromagnetic interference problems from the nearby powerhouse and transmission lines and elimination of standpipe obstructions in the spillway associated with conventional piezometer construction (Sobczyk 2013).

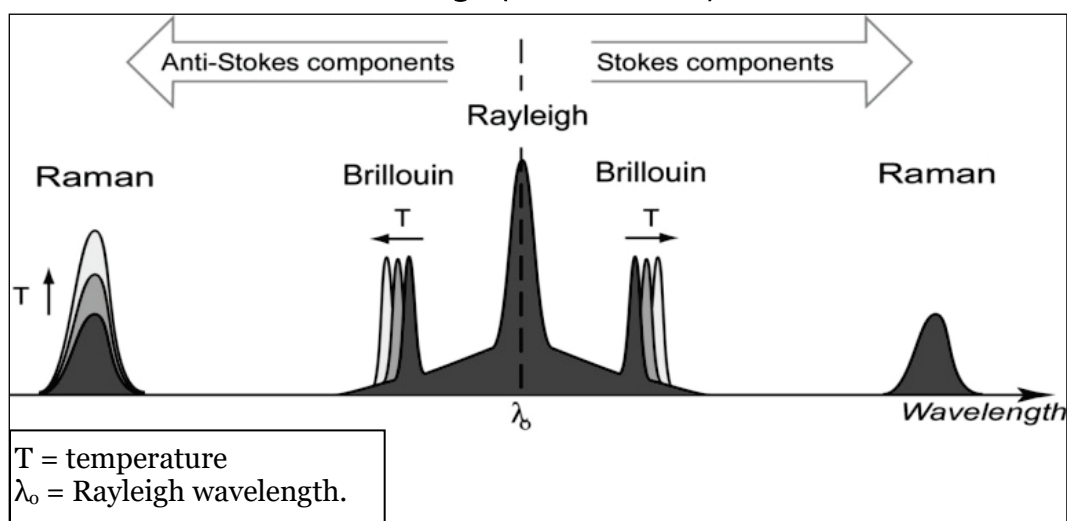
Multiplexed sensors incorporate multiple measuring points along the fiber length using fiber Bragg gratings. These gratings are periodic alterations in the density of the glass core by exposure of the fiber to intense ultraviolet light (Inaudi and Glisic 2007a). These gratings have a finite length of 10 mm and operate by filtering out certain wavelengths of light passing through the grating. The grating is strain and temperature dependent. The spectrum of the light that is reflected is used to measure precise change in these parameters. Multiple gratings along the fiber length with their own specific wavelength filter characteristics permit numerous unique measuring points along the cable path. A reference grating is used in applications involving both strain and temperature to correct strain values for temperature effects. Between 4 and 16 gratings can be measured on a single fiber.

SOFO interferometer sensors involve gage lengths between 200 mm to 10 m and measure displacements in the micrometer range. Low-coherence interferometry is used to measure the difference between two optical fibers installed on a structure. The measurement fiber is coupled to the structure, while the reference fiber is free from the structure and acts as a temperature reference to determine the displacement that occurs across the structure being monitored. Low-coherence interferometry is an optical imaging technique that can use either time domain or frequency domain methods to precisely determine axial position of an object in the direction of light propagation through low coherence gating methods. The technique has been successfully applied at more than 300 structures including bridges, tunnels, piles anchored walls, dams, historical monuments, and at nuclear power plants (Inaudi and Glisic 2007a).

Distributed sensors involve a single-fiber optic cable measuring temperature and strain along thousands of points to distances of hundreds of kilometers in length with a single measurement instrument (Inaudi and Glisic 2007b). This technology is especially attractive for monitoring large flood-control structures, such as dams and levees, and monitoring movements of large areas such as landslides and abandoned mines. The

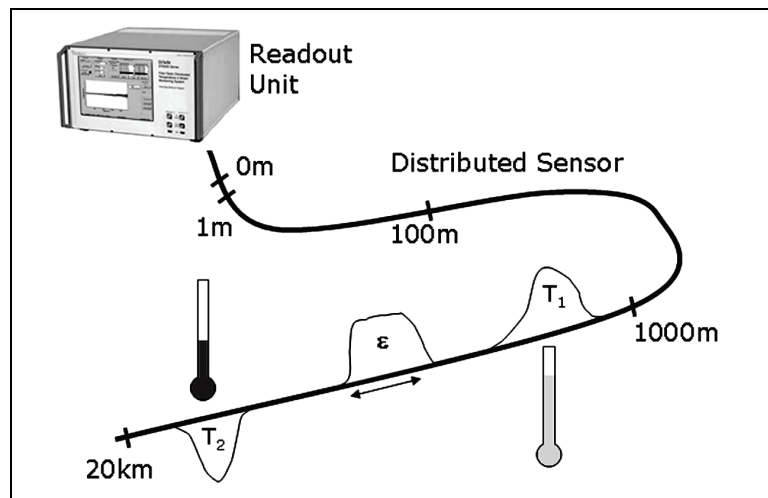
principle behind the sensing method involves the return reflections of backscattered light of a known wavelength from every location along the fibers path. A pulse of light with known wavelength propagates through optical fiber causing both forward and backscatter of the light along each point in its path, which subsequently creates both higher and lower wavelengths in the backscattered component than the original pulse (Figure 5-55). Distributed sensing methods are based on the analysis of the backscattered signal at different points along the fiber pathway. The scattering process is caused by material impurities in the fiber (Rayleigh scattering) and produces thermally excited acoustic waves or Brillouin scattering and atomic (molecular) vibrations corresponding to Raman scattering (Omnisens 2009).

Figure 5-55. Components of backscattered light from a single mode laser or single wavelength (Omnisens 2009).



Distributed sensing methods are based on the analysis of the backscattered signal at different points along the fiber pathway (Figure 5-56). Temperature measurements along the optical pathway are based on the intensity ratio of the lower wavelengths between the two Raman peaks, which are positioned symmetrically on either side of the Rayleigh wavelength (Inaudi and Glisic 2007b). The position of the two Brillouin peaks relative to the Rayleigh wavelength is proportional to the temperature and strain experienced by the fiber. This strain affects the density of the fiber locally, which causes changes in the acoustic velocity and the relative position of the Brillouin peaks to the central Rayleigh wavelength. Precise measurement of the temperature by the Raman component permits accurate determination of the strain in the Brillouin component.

Figure 5-56. Idealized diagram showing distributed strain and temperature measurement system for use in levees (Inaudi and Glisic 2007b).



Pulsed light through the optical fiber is used for making measurements and is analogous to radar techniques used to monitor temperature and strain at 1-m intervals up to distances of 30 km (Inaudi and Glisic 2007b). The concept of spatial resolution for distributed optical fiber methods is dependent on the fiber length and the interval extent to be sampled. Inaudi and Glisic (2007b) report temperature accuracy on the order of $\pm 0.1^\circ\text{C}$ at a spatial resolution of 1 m up to 8 km in length, and a strain accuracy of ± 20 microstrain at a spatial resolution of 1 m up to 30 km in length. Because of the small diameter and fragile nature of the optical fiber, it is necessary to strengthen the fiber with reinforcement to prevent shearing and elongation. Thus, for strain measurements a reference fiber is incorporated into the cable design that is not affected by the strain component to determine elongation and lateral displacements that may be occurring locally.

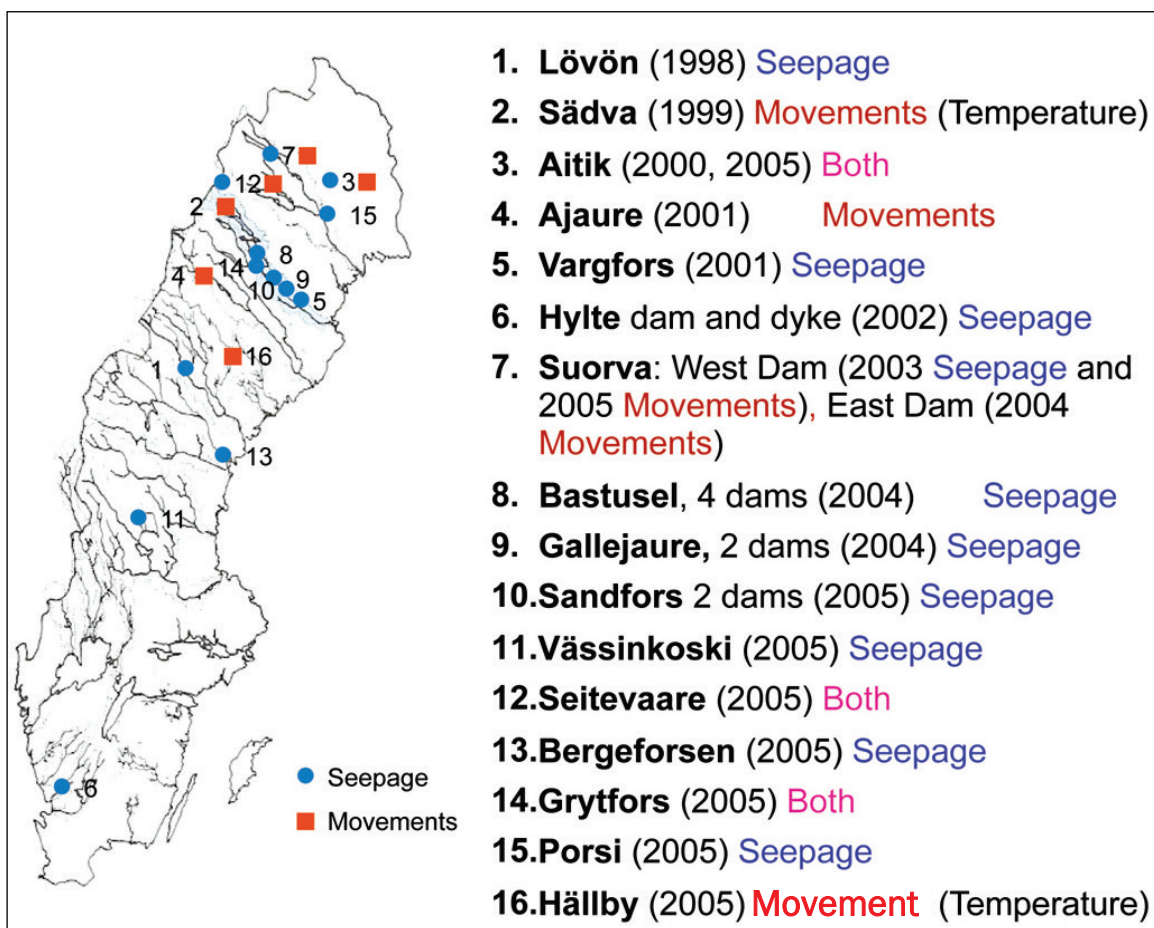
Fiber optic technology is an especially attractive method for monitoring and early warning of potential displacements in hydraulic-control structures because of the distributed sensor capability and associated multiple points of monitoring along the entire pathway. A single-fiber optic cable buried along the downstream face and toe of the dam or levee as a series of connected parallel lines along the longitudinal axis would be especially advantageous for early warning of potential embankment and abutment movements due to seepage, settlements, slope stability, or seismic displacements. The ability to monitor changes in local water temperature across the axis of the dam or along protected levee reaches from seepage-related issues has broad appeal for identification of localized

seepage areas and determination of changes in condition due to water temperature through time. Ideally, multiple fibers or a single distributed fiber would be installed at multiple depths beneath the dam or levee to monitor seepage conditions as a function of depth. Areas where thin top stratum occur beneath the levee, and/or point bar deposits involving ridge and swale topography that crosses the levee right-of-way are considered potential research areas for use of optical fiber to determine capabilities of this technology for continuous monitoring.

Fiber optic monitoring of dams has been extensively employed in Sweden since 1998 (Figure 5-57). More than 25 dams have been monitored to date, primarily monitoring temperature to detect seepage but also monitoring for movements (Johansson and Sjö Dahl 2004, 2009; Johansson and Watley 2007). Dutch researchers have also conducted studies of instrumented levees using fiber optic technology as part of the IJkdije (pronounced Ikedike) experiments for monitoring underseepage and piping failure mechanisms (De Vries et al. 2010; van Beek et al. 2010). Dutch levee tests at the IJkdijk test site were designed to model typical deltaic soil conditions found in the Netherlands, involving low density organic soils overlying a thin sand layer. This geologic setting is not typical of alluvial valley type meandering river systems and associated point bar deposits characteristic of most major river systems in the United States. However, Dutch research efforts bear further monitoring to assess continuing improvements in sensor technology and deployment throughout their flood protection system.

Another important research effort involving automated levee monitoring and early warning is being developed by the state of Louisiana in New Orleans. The Office of Coastal Protection and Restoration has funded the iLevee demonstration project to evaluate numerous sensor technologies throughout Orleans and Jefferson Parishes (Brouillette 2012). Fiber optical cable is one of many technologies being tested at the 17th Street Canal to monitor displacements and seepage between the I-wall and newly rebuilt T-wall sections. Other technologies are being incorporated into the automated system design and early warning to monitor water levels, pore pressure, displacements, and movements of vulnerable I-wall and T-wall reaches. The iLevee project is discussed at the end of this chapter in more detail.

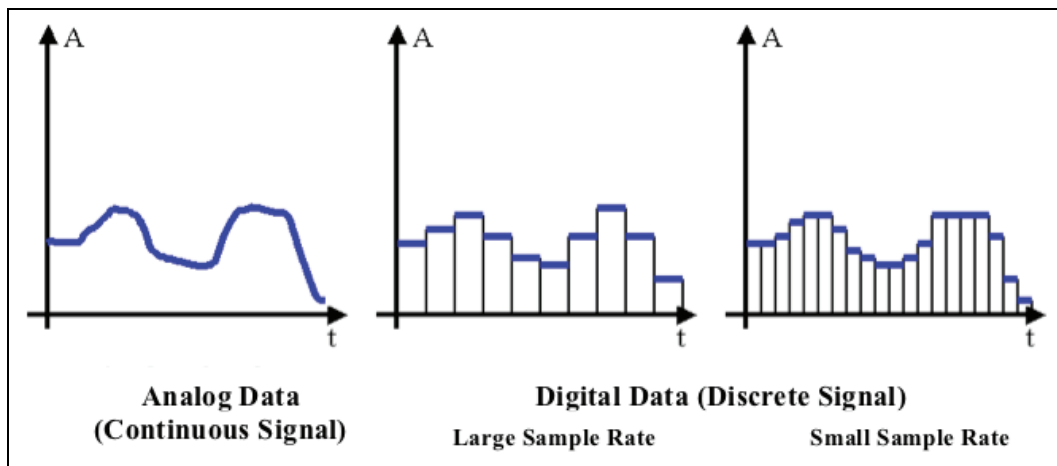
Figure 5-57. Dams in Sweden equipped with optical fibers for seepage monitoring for temperature and movements (Sensornet 2012, <http://sensornet.co.uk/images/PDF/download95dd.pdf>).



5.8 Engineering data from instrument sensors

Instruments are able to collect sensor readings at any given time. However, the way the readings are output is different and can affect the way data are interpreted. Output data received from instrumentation come in two different signal formats: analog (e.g., voltages, frequency outputs, phases) or digital (Bassett 2012). The term analog data refers to the continuous variation of electric signals that resemble the variation of the physical quantity of interest, and it may also be referred to by the term continuous signal. In contrast, digital signals are not continuous and consist of pulses or digits with discrete values (e.g., 1 or 0) and hence, are known as discrete signals. Figure 5-58 shows the difference between analog and digital signals in variation through time.

Figure 5-58. Difference between analog and digital signals from a sensor (Wagner 2013).



In principle, the digital signal is a sample of the analog signal for any point in time. As observed in the figure, the digital signal resembles the analog signal. The shape of the digital signal depends on the data sampling rate. If the sampling rate were significantly increased, the digital data would approximate a smooth curve and look closer to the shape of analog data, though never as smooth.

In current applications, most of the analog data is being digitized, either within the instrument or at the point of collection (Bassett 2012). This conversion allows for easier storage of signal readings, adds to the flexibility for later data processing, and the ability to catalogue these sometimes large amounts of data.

Measurement of geotechnical field data can be obtained through different methods, either manually obtained and hand-booked (e.g., water-level indicators) or obtained using handheld units or data loggers. For the purpose of this report, remote monitoring software usually involves data loggers storing digital readings, and sending these data to a central location for monitoring.

Processing can take place at the data logger or at the central monitoring location. Part of the processing involves converting the signal readings, often referred to as the raw data, into engineering values and making use of calibration factors. Additional processing involves data reduction and error corrections. The processed data can be used in many different ways using Microsoft (MS) Excel spreadsheets, database software, GIS, and

visualization software, or manipulating the data as the user sees fit. These different applications are discussed in more detail in the following section.

5.9 Remote monitoring and data storage software

5.9.1 Introduction

Managing and organizing large amounts of data from data entry and automatic data acquisition systems (ADAS) is an arduous task, sometimes requiring the use of software to catalogue data, to make it readily accessible to users. ADAS software stores readings from instrumentation and other relevant information in databases to make it easier to query and monitor system performance. Several elements need to be considered, involving how data are going to be collected, verified, visualized, stored, and disseminated to establish databases for geotechnical monitoring (Cook 2010).

As technology has improved and computers have evolved, software applications have been tailored to meet the demands of each specific project. MS Excel has traditionally been the preferred tool to visualize field data (Cook 2010). This condition is mainly due to its availability, easy manipulation of desired functions, and plotting capabilities. Templates can be created in MS Excel and/or similar plotting software (e.g., Grapher) to receive input files to display and manage these data. Also, different manufacturers have developed their own software tools to work with their instrumentation systems. Improvements include embedding monitoring capabilities within a GIS framework, making it easier to assess historic performance involving flood-control structures.

5.9.2 Selection considerations

Considerations involving software and database management requirements include the user expectations, the needs of the project, and why the instrumentation data will be collected and evaluated. Does the structure have monitoring concerns? How will these data be collected and evaluated? Factors involved in these decisions include:

5.9.2.1 User-friendliness

Although more functions are always great to have, the user should realistically analyze the project's requirements and the item of interest for which instrumentation needs were placed and designed to monitor. Other

considerations should be the adaptability of the software to other sites and/or other applications.

5.9.2.2 Manual data input versus remote instrumentation

Although a remote monitoring system is ideal for any project, the funding required to install a complete monitoring system is often limited. With the intent of adding monitoring capabilities, remote systems are installed, but other instrumented locations may still require manual data collection. All data collected are valuable, regardless of whether they are remotely or manually collected. All data should be kept in the same location to allow for easy review and quick comparison of the different trends. Software should have the capability to allow input of manual data and those collected from data loggers to allow consistent formatting for easier review of these data. An important requirement for data manually entered, the verification process should be correctly time stamped to avoid incorrect interpretations of these data at a later date.

5.9.2.3 Data presentation and data export

A variety of data presentation displays is available: georeferenced to a GIS interface, data presented in a cross section drawing of the instrumented structure, and 3-D visualization. Similarly, there are other ways of displaying the data based on the project problems and the items of interest. Regardless of the color, attractiveness, or functions of the interface, presentation of these data should always maintain a similar background for temporal comparison. The display interface should be simple enough to describe existing conditions, while thorough enough to provide additional information required for quick analysis and reliable decision-making. General information, such as location, instrument type, historical data, log of observed conditions, and pictures, are helpful to determine unexpected conditions. Flexibility of the interface to select instruments and the ability to quickly modify graphs are desired functions of the software.

Visualization of field data and their trends is an important feature for any software. Showing plots of monitored data enables observations of data trends through time, position, or other preferred correlations. Plotting of instrumentation data is often standard but having the flexibility to look at the data in different ways can be a desired option to have inside any software. In addition to graphically observing the data, it is desired to look at data numerically to review and perform statistical operations. Both raw

and processed data should be stored and made available for later in-depth study. Another important feature is the ability to export data files to formats supported by commonly used software (e.g., Excel) or graphing program (e.g., Grapher). However, export tools should not be a substitute for having a quick preview of the data within the collection software. A robust display functionality and export capability will enable users to better calibrate and manage sensors, correlate with other available data, compare to expected or actual historic readings, and identify situations where errors due to faulty instruments occur.

5.9.2.4 *Real-time monitoring*

The concept of real-time monitoring is important for early warning of poor performance and conditions leading to failure. The user should understand that there will always be a time delay between when the data is collected and delivered to the user, or shown graphically by the software. These time delays are called response times and depend on various factors including sampling rate, archiving of data, processing requirements, communication and network issues, data-traffic, and interface visualization procedures.

5.9.2.5 *Instrumentation maintenance QA/QC*

In an ideal world, instrumentation would not require any maintenance, and data would be error free. Regrettably, maintenance is needed for monitoring systems, ranging from operation maintenance (e.g., changing batteries, cleaning sensors) to technical maintenance (e.g., calibrating equipment, programming updates). The concept of discriminating data to assist in maintenance operations is required because remote monitoring relies heavily on these readings. Early detection will likely reduce the amount of time gaps in the data, and the quality of the data will significantly increase. The maintenance activities performed on the sensors should be time stamped and logged to assist further review and analysis of data because it is likely that readings will be affected while maintenance activities are performed. There is a likely probability that data collection may fail because of mechanical issues. Consequently, performing QA/QC functions should be incorporated to permit error checking and identification of suspect data.

5.9.2.6 *Project application*

Project-type application plays a role in the software and remote monitoring requirements. If the application is to monitor construction activities (i.e.,

short-term monitoring), then knowing present conditions may be the most important matter (Lemke et al. 2011). Whereas when sensors are installed for structural performance monitoring (i.e., long-term monitoring), having available historical conditions may be even more necessary to understand observed changes in time series data to predict future occurrence. Use and application of the data will depend on the user and the specific project's requirements.

5.9.2.7 *Trigger alarms*

Alarm-monitoring services for homes capable of detecting theft, fire, carbon monoxide and other parameters are common. Similar type monitoring technology is currently available for levees and dams using geotechnical instrumentation. An emergency action plan, in conjunction with instrumentation data, and threshold triggering values is possible for 24/7 real-time monitoring. The goal being owners and operators are notified when conditions exceeding user pre-established threshold values, or sudden changes occur, for which personnel should be alerted. Notification of these conditions in conjunction with online data streams (e.g., USGS, NOAA) involving weather, water level gages, and other natural hazards data permits assessments of real-time conditions and improves public safety. To establish an alarm-monitoring system, consideration must be placed in the design to ensure personnel will respond in a timely and efficient manner to the warning. Communication methods (alarm, Internet, phone call, email) need to be established to make sure information is received during an emergency event, and the alerts should be concise to explain sudden unacceptable or unexpected changes in condition without creating false alarms or exaggerating problems. The personnel responsible for receiving these alarms must be readily available and willing to deal with any triggering events at any given time or day.

5.9.2.8 *Software modification*

Manufacturers sell their software products as an all-encompassing system that can be easily adapted to a variety of sensors and situations. Most of the available systems are designed to work with a specific set of data loggers, for which they were pre-programmed, and a specific set of instrument types, for which the software was developed. Proprietary software systems can restrict the user's ability to modify and adapt the software to their specific needs. Many of these changes can be done only through the manufacturer. However, these systems result in additional costs, not initially anticipated,

and reduce the ability to tailor to specific project needs. Non-proprietary software can have limitations as well. Users can become frustrated after familiarity with the limitations of the software and later decide to link to an older version, a newer instrumentation system from a different manufacturer, or a different type of application. At the earliest stage of the project, limitations of the system should be evaluated and determined to avoid dissatisfaction with the product and potential limited capability.

5.9.3 Web-based versus desktop software

An important consideration for software is whether Web-based or a desktop environment is more appropriate for the application. Accessibility, upgrade maintenance, security risks, data storage, and costs for the system will play a major role in the software selection. Monitoring software has been developed in a Web-based environment, typically with rich Internet applications to allow data to be managed inside the Web interface. However, certain advantages and limitations exist when compared to desktop applications.

5.9.3.1 Internet connection

Web-based software allows access anywhere, anytime, with any browser-enabled device (e.g., laptops, smartphones, and tablets). There are no requirements other than an Internet connection. Security is enabled with virtual private network (VPN) connection and password. Use is limited to Internet connectivity and speed. An advantage of desktop software compared to Web-accessible is the ability to see and interpret data locally when an Internet connection is not available. Although the desktop software will not receive new data when not connected to the Internet, all previous data are stored locally to examine historical trends.

5.9.3.2 Software maintenance and upgrades

Other important considerations are maintenance and upgrades to the software. Maintenance is automatically performed for Web-based applications from a central server and is typically scheduled beforehand. Desktop software residing locally requires user installation, time to install, fixing bugs, and hardware compatibility issues.

5.9.3.3 *Software security*

In both Web and desktop applications, security risks are present. Security considerations are required at the beginning of establishing a remote monitoring system, from the sensors to the software. Security risks involved may be different based on the character of the computer and the network on which the software is installed. Security risks on the Web-based software are monitored by the host providing the service, while for the desktop software, the risk is borne by the user. Data storage and backups are an essential task for a system administrator involved in a monitoring program.

5.9.3.4 *Data storage*

Storage of data for Web-based and desktop systems requires scheduled backups. In a Web-based environment, data are automatically stored redundantly in multiple servers. If one server fails, then the software automatically seeks another server for write access. For a local desktop configuration, data are stored locally or to a network server. Regardless of where the data reside, backups on multiple drives should occur at different locations in case of any unexpected mishaps.

5.9.3.5 *Software costs*

Last, and perhaps most important, are software costs. Desktop applications have a high upfront cost, require more user-maintenance, and have recurring upgrade costs. However, users have more control of the data and the system. Web-based software in contrast has a monthly or annual subscription cost, which can change through time. Web-based configurations are seemingly maintenance-free and allow more access. However, users have limited control of the data. In the long run, Web applications are generally considered to be more expensive, because of the recurring costs, as compared to the one time upfront cost for desktop applications. All these factors should be evaluated carefully for project specific needs.

5.9.4 Summary of software considerations

Many considerations need to be taken into account when looking into remote monitoring software to manage large data streams from sensors. An important consideration is the required level of functionality for the system and needs for future applications. Commercial instrumentation companies provide both Web-based and desktop-based software to be used on a computer or network. Careful planning and study are required to ensure

project and user's needs are met. Every project has budget limitations, but the required functionalities and project needs should be addressed. Funding should be set aside for maintaining an instrument program in larger projects such that quality is not compromised. Careful attention should be given to lowest bids on system integration to ensure the project requirements are met or exceeded.

5.9.5 WinIDP and DamSmart

5.9.5.1 Overview

The USACE Dam and Levee Instrumentation Committee (DLIC) in their FY 2011 Annual Report recommended a Windows Instrumentation Database Package (WinIDP), managed by URS Corporation (USACE 2012a). A review of available commercial monitoring software by USACE indicated that WinIDP had most of the desired capabilities and functionality needed for their requirements. However, the DLIC noted that none of the evaluated software systems were ideal. An overview of the history, use, and functionalities of USACE WinIDP and DamSmart are discussed in the next sections.

WinIDP is a menu-driven, PC Windows' desktop-based database software that can store, process, retrieve, and graphically present instrumentation data, either manually inputted, or automatically collected. It was designed to manage instrumentation involving long-term performance monitoring of dams, levees, tunnels, and other civil infrastructure projects, but it can be applied to short-term construction. The software has the capability to automate data reduction, reporting, and plotting for multiple projects.

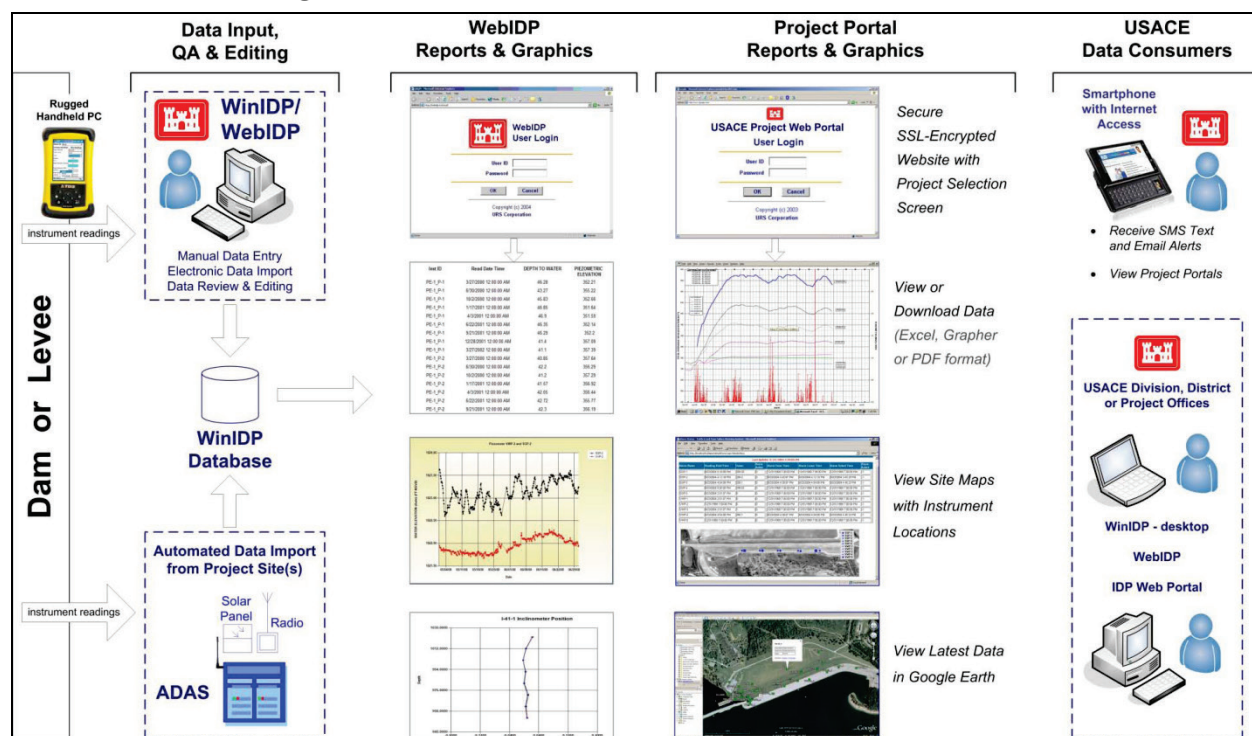
URS has a commercial version of WinIDP, called DamSmart, that is nearly identical to WinIDP. The main difference between the two configurations is WinIDP is only available to USACE. DamSmart is commercially available and includes a Web-based version called WebIDP, which provides for a secured IDP Web and smartphone access. This smartphone version is not available to USACE due to network security restrictions. An overview of the WinIDP/WebIDP Architecture is presented in Figure 5-59.

5.9.5.2 Background

Initial development of WinIDP was started in approximately 1986-1988 by Woodward-Clyde Consultants to manage instrumentation data from Merrill Creek Reservoir in New Jersey and Clarence Cannon Dam in

Missouri. The first commercial software version was released in 1989 to monitor the construction activities of a pumped-storage hydroelectric station and the initial filling of Bad Creek, South Carolina (USACE 2012b).

Figure 5-59. WinIDP/WebIDP architecture (USACE 2012b).



Interest in WinIDP began in 1990 by USACE Headquarters, with a general survey sent to the Districts on the needs of dam safety instrumentation and compatibility with existing databases. Based on results of this survey, a version was developed by the USACE Waterways Experiment Station (now known as ERDC). The USACE Dam Safety Program in response developed the Instrumentation Database Program (IDP). This program was converted to a Windows-based version in 1993 by Woodward-Clyde Group and the name was later changed to WinIDP to include the new changes (USACE 2012b). Woodward-Clyde Group joined URS in 1997, and the software has since been managed by URS. The program has been updated several times since its conversion to Windows. Upgrades include a Web-portal, GIS modules in 2003, smartphone Web access (in DamSmart version), newer output formats, external software templates (e.g., Grapher, Excel), and automating tasks for data importing and plotting. Currently, the latest version is 5.5d.

5.9.5.3 Applications

WinIDP and DamSmart combined are being used on more than 400 dams worldwide, and currently about 15 USACE districts. Software developed was intended for dam projects, but it can be used in any application involving instrumentation. The software has been used in levees, tunnels, bridges, ash ponds, buildings, landslides, mine pit slopes, landfills, and highway embankments (USACE 2012b). Usage will likely increase because of the USACE recommendation for WINIDP and their increasing instrumentation needs.

5.9.5.4 Hardware and software technical requirements

A minimum random-access memory (RAM) of 2GB is required to handle all related software, but the program itself can run with a minimum RAM of 64MB. Storage space will vary depending on the number of instruments and data collected. Software currently operates on a 32-bit Windows operating system and is compatible with MS Windows 2000, Windows XP, Windows Vista, and Windows 7. Regardless of which Windows version is used, the user is required to be the administrator of the system for it to work properly.

Because WinIDP is a database management program, it requires commercial compatible databases to work with the software. The newest version of WinIDP is compatible with Microsoft SQL Server (Versions 2000, 2005, 2008, and Express), Sybase (Adaptive Server Anywhere 9 and SQL Anywhere Version 5 and 5.5). In order to establish a database for a project, or make any changes to the structure of an existing database, a local database administrator must be involved. Currently, WinIDP requires external software to plot data. Compatible plotting software includes MS Excel (MS Office 1997 to 2010), Golden Software's Grapher (Versions 6 to 8), and MS Visio (Versions 2000 to 2010). The software is compatible with ESRI ArcView (Versions 8.2 and later) for GIS applications. It is currently configured for handheld data loggers, including Geomation (now RocTest) OutDAQ Equipment, Campbell Scientific Systems, Geokon, and RocTest dataloggers.

WebIDP requires an Internet connection and network connectivity to the instrumentation database and the local machine to be connected to the network with no access restrictions by the software. Internet project

portals may be created to aid in individual monitoring and to restrict access to project data in the user community.

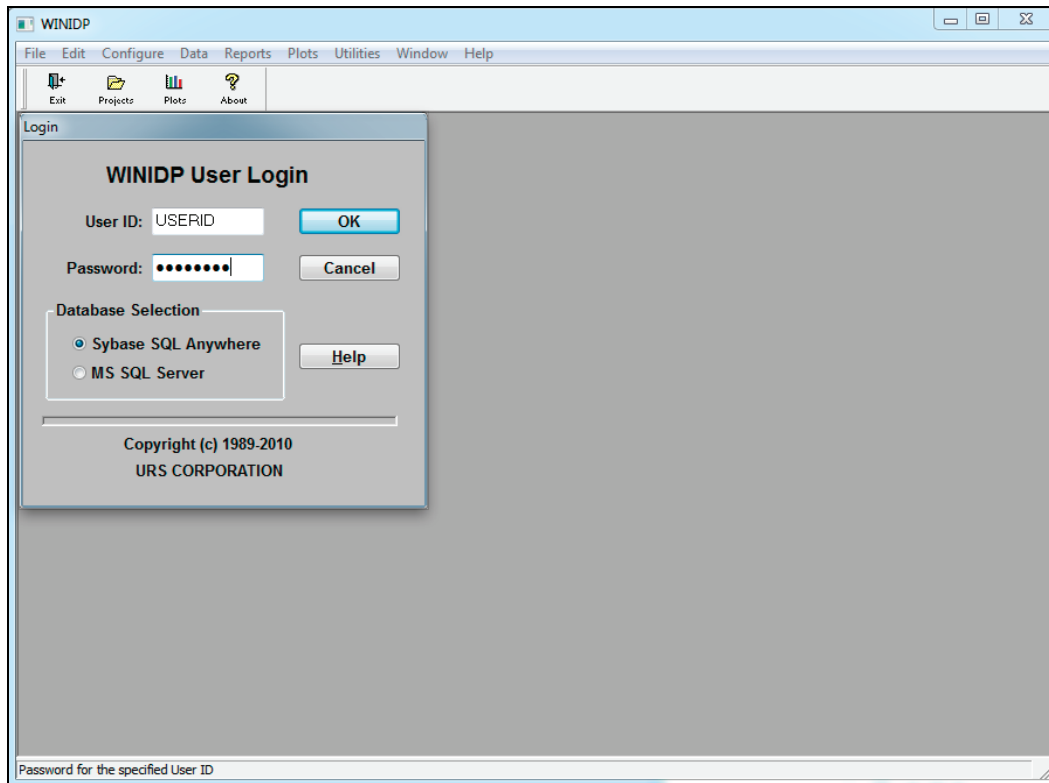
5.9.5.5 *WinIDP features*

WinIDP has a lot of useful features and tools. It can manage geotechnical and infrastructure instrumentation data in one system for an unlimited number and size of projects. The software integrates data input and processing, data reporting, visualization, and exports information to GIS applications (URS 2010a). Some of the features of the software are described below to show its potential use and as an introduction to the software.

The first step requires the user to decide if a network or a local machine will be used. For example, when connected to a network, multiple users can concurrently access the database and look at the data. Conversely, when using a local computer, the user will have more control of the data. Next, the user will select the appropriate setup installation. For the purpose of this report, the “Runtime Option Two” version was reviewed to illustrate the use of the software based on the WinIDP Tutorial developed by URS. This option allows for the use of MS SQL Server and/or Sybase Adaptive Server Anywhere. However, the basic difference from this version and the full version (i.e., Stand Alone installation) is the control of the databases for the sensors, which is not covered in this report. The database should be set up by the organization’s Database Administrator (DBA), using documentation provided with the WinIDP software. Overall, the software itself provides a quick and straightforward installation path and requires support from the DBA to create the databases to be used.

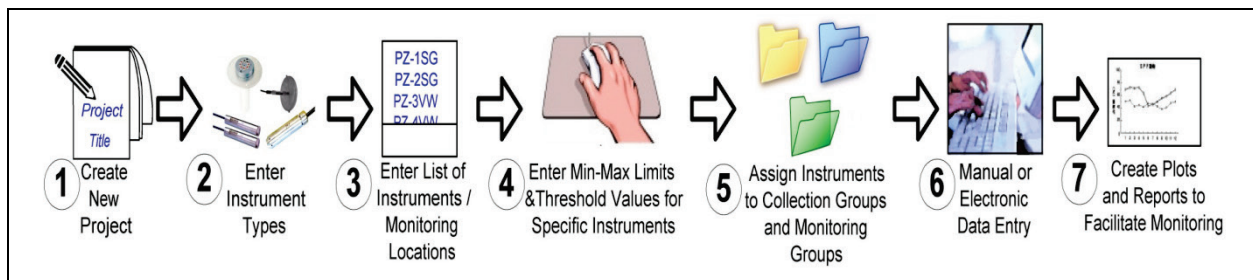
The first requirement after starting WinIDP is to sign-in using the User Login screen (Figure 5-60). The System Administrator establishes up to three login security/access privileges for each user. Level 1 is the Basic Level where a user can enter data, group different instruments for plotting, and generate outputs. Level 2 is the Data Management Level and allows the Level 2 user to edit data, configure instrument types, and individual instruments. A Level 3 user has System Administrator (SA) privileges. An SA has the capability to manage the list of projects and users’ privileges.

Figure 5-60. WinIDP interface.



After the user is logged in, the Project Selection window will open. Here the SA is the only one that can add, create, or delete any projects. Any user (i.e., Level 1, 2, or 3) can open a project to look at the instrumentation data available for each project. Figure 5-61 shows the workflow in WinIDP from creating the project to creating plots.

Figure 5-61. WinIDP workflow (USACE 2012b).



Subsequent to creating a new project database, the user is required to configure the types of instrumentation and their characteristics (i.e., Instrument Type Definitions), enter each of the instruments (i.e., Instrument ID Definitions), create Collection Groups for collecting data,

and establish Monitoring Groups to group different instruments for plotting.

The WINIDP software is preconfigured with 25 types of instruments (Step 2 in Figure 5-61) with standard calculations and setup. The user is also able to add and configure new instrument types using their own preferred terminology. Available instrumentation types can also be edited to preferred nomenclature of variables, constants, field conditions (either numerical or descriptive), set data reducing equations to calculate values from raw data, field conditions and constants, and also add spatial definitions for interfacing with GIS. Instrumentation type definitions allow setting threshold limits, including reference information, and adding comments as necessary.

The next step following the instrument definitions is the configuration of individual instruments available in the Instrument ID definitions window. These will be based on the initially defined Instrumentation Types. There are no limits to the number of instruments that can be created. For each instrument the user can: define the instrument's status (i.e., Active or Inactive), installation date; include additional instrument specific date effective constants not originally included on the instrumentation type definition; add minimum, maximum and change thresholds (used to compare against previous reading) for the raw and calculated data; add threshold values and reference data based on the thresholds and reference data defined in the instrument type; and add instrument specific comments.

After defining the different instruments in the project, data are ready to be collected. WinIDP uses Collection Groups to facilitate importing or entering data for one or more instruments at the same time into the software. Instruments in an Automatic Data Acquisition System (ADAS), instruments of the same type, and instruments collected during the same time, are usually defined in a Collection Group. Monitoring Groups are created to plot different instruments in the same plot. They allow a reduction of the number of instruments to be plotted and are ideal to use in large project evaluations of instrumental data.

After the initial configuration is completed, actual instrument data are obtained. Data are manually entered, or imported through an ADAS system, from Handheld (HHD) or field data loggers, or standard data file format (i.e., CSV). These data will be collected based on the Collection Groups

previously defined. For the manual entry mode, all that is required is the collection date and selection of the appropriate Collection Group, then data are entered into the available fields and collection details added. The other means of importing data (i.e., ADAS, HHD, and CSV) involves a two-step process. First, the user needs to set up the procedure for data importing to define instruments that will be imported and relate the file columns and field (column) headings, or map network strings to parameters established in WinIDP. The next step is to import the data. In the data import, calculations and reductions are automatically performed.

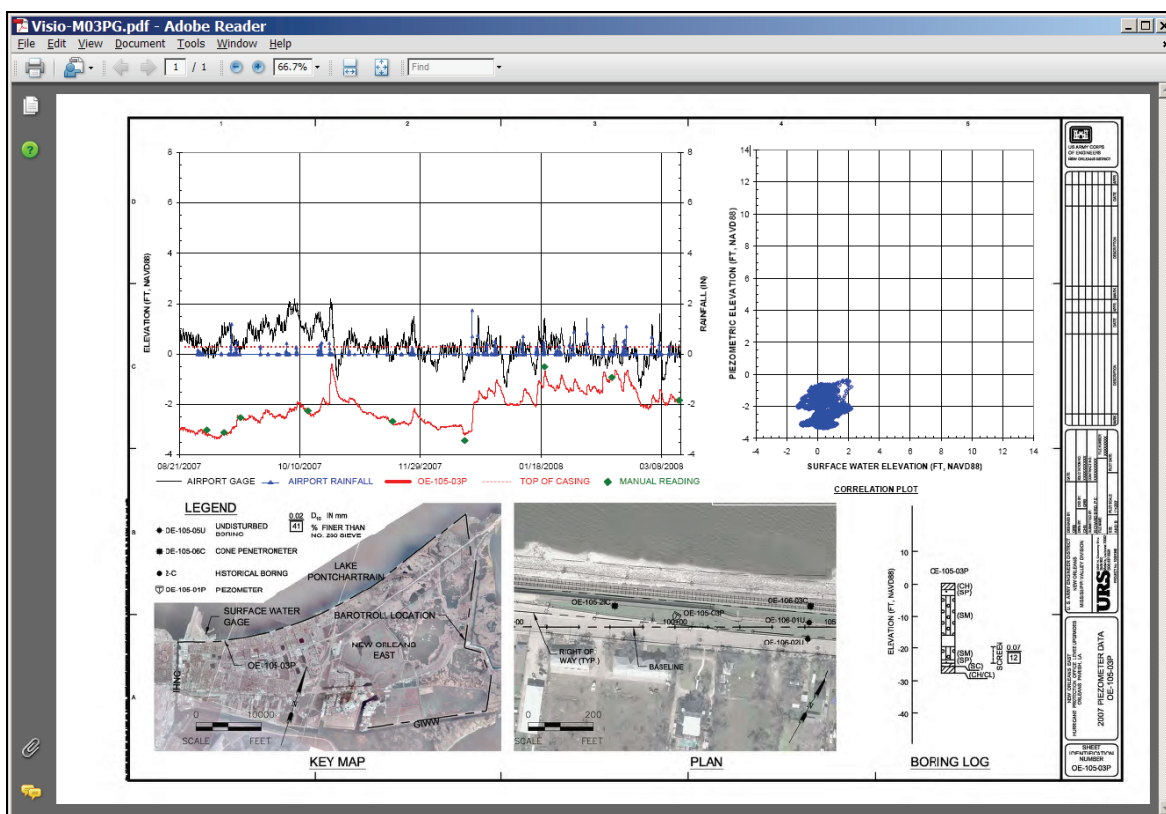
Data imported and entered can also be edited inside WinIDP. Error checking will verify edited values against raw data and calculated data against allowable ranges and thresholds as established in each Instrument ID. Masking of data eliminates anomalous readings from being shown in plots and reports. ReCalc option is also available to recheck modified data against thresholds and minimum and maximum values.

WinIDP has the ability to automatically generate reports. Four different types of report options exist: Readings, Definitions, Exceptions, and Excel Cross-tab reports. Readings reports are used to present the data for selected Instrument IDs and Instrument Types. Definitions reports are used to show information about the way the project is configured. Exceptions reports are used to show reading exceptions, which include exceedances of the defined range of values and thresholds. Excel Cross-tab reports are used to create an output Excel file with the information selected to allow users the flexibility of managing their data. Each option includes predefined reports, which the user modifies and adapts to particular needs. Users can also create a custom report by selecting the type of instruments, and specific instruments, and show all or masked data, statistics, and definitions. For each project, the user can create multiple user-defined reports that run in the future and obtain reports with the most recently imported data.

WinIDP has a plotting module, which is another important feature. This module facilitates graphing through external software, such as MS Excel, Grapher and MS Visio. WinIDP allows users to generate time-histories and correlation plots. Time series plots are often used to observe long-term performance through time. Position plots compare readings to the locations of the instruments. Correlation plots compare readings from two different instruments, or different parameters from an instrument. To generate plots, the user specifies the instruments, or through Monitoring Groups, and then the values to plot for each axis. WinIDP provides basic

formatting capabilities to MS Excel and Grapher, but the user can customize or create many plot definitions and templates to accelerate the plotting process. Plot definitions allow users to run a number of plots at the same time using batch techniques. Additionally, users can merge plots with other objects, such as drawings or pictures, creating MS Visio or Grapher templates (Figure 5-62). Other options available are the ability to automatically plot the defined plots using the daily averages or all the data.

Figure 5-62. Merged plots that can be generated using MS Excel and MS Visio (USACE 2012b).



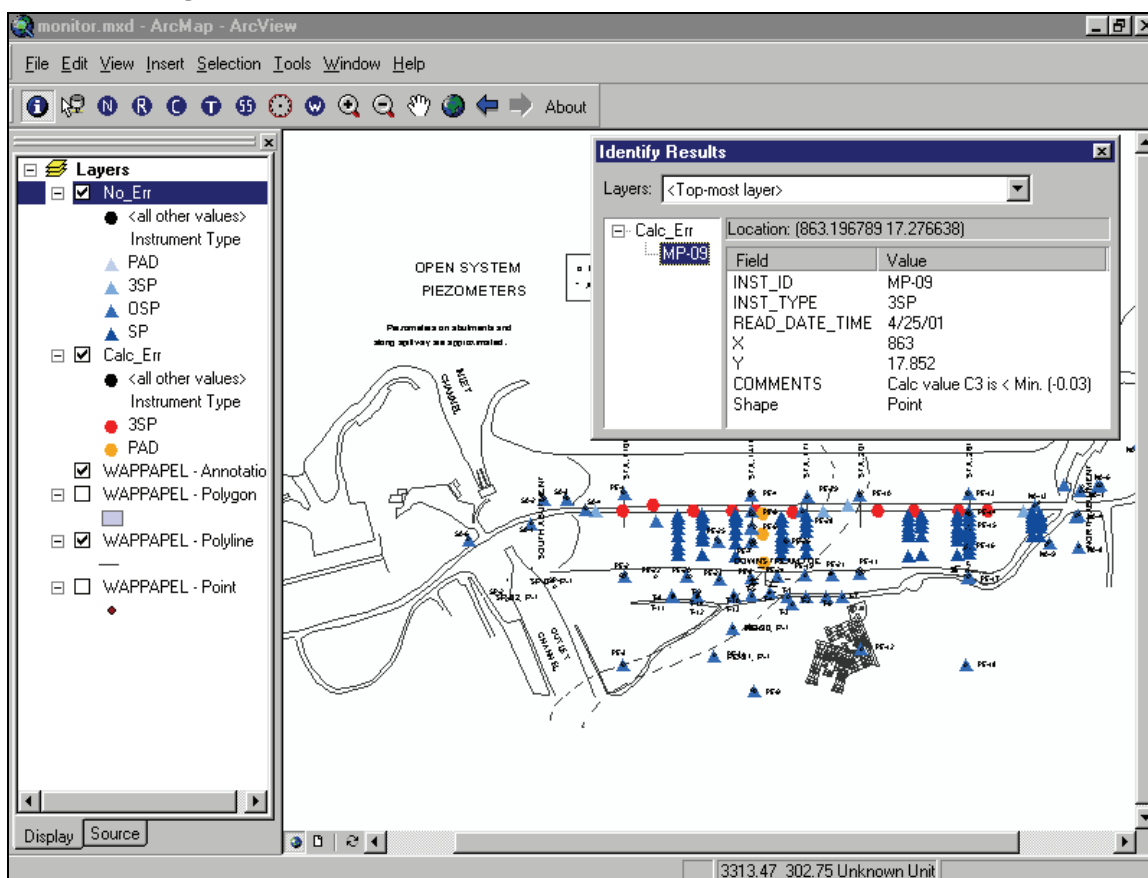
A GIS module exists as the Graphical Data Assessment Monitor (GDAM). The module uses ESRI ArcView/ArcGIS software and creates a toolbar extension in the program to open the project map and display data using the constants defined in the Instrument Types and Instrument IDs. The interface can integrate photographs, logs and drawing files inside GIS and display active instruments that are color-coded based on user-defined thresholds (Figure 5-63). This interface can be set to update at selected time intervals to make sure populated data are the most recent available.

WinIDP/WebIDP and its parallel commercial program DamSmart have added a recent initiative that includes a GIS Web-based interface to

integrate queryable spatial databases, Google Earth maps and pictures. Other initiatives include handheld data entry devices, smart phones, and project portals.

WinIDP is an exclusive program of the USACE and is maintained by URS. Software updates and costs are shared within the USACE organization. The software is available free to USACE members and only requires modest support costs.

Figure 5-63. GDAM Interface in ESRI ArcView/ArcGIS (USACE 2012b).



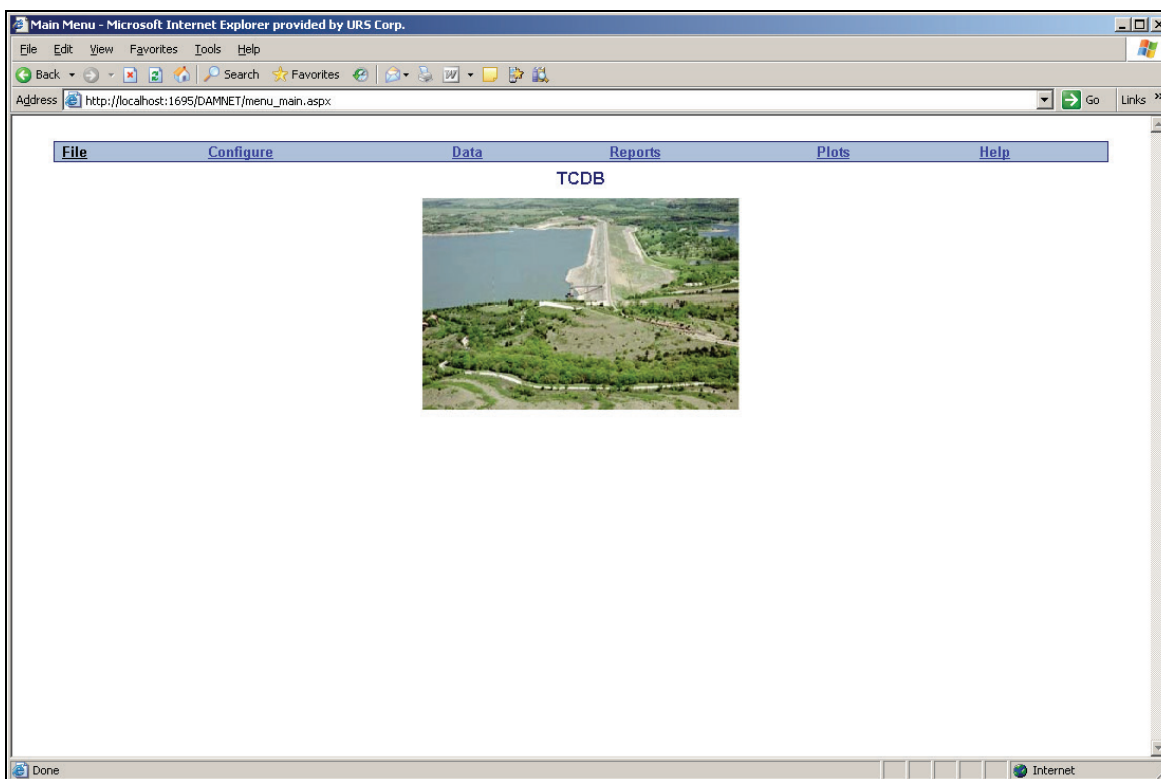
5.9.6 WebIDP

A Web-based version of WinIDP is also available called WebIDP. The main interface is shown in Figure 5-64. The Web version mirrors the Desktop-based WinIDP software with the main advantages of not having software and physical files on your local computer.

The interface is essentially the same found on WinIDP. The Web version allows for data to be entered, imported, and reports and plots to be

generated. It has minor limitations (e.g., limits numbers of Collection Groups and some of the import functions are not available), but overall, is similar to the desktop-based version. It has basic internal plotting tools and has a predefined Definitions Report and an additional type of report called Latest Readings to look specifically at the most recent data. Another feature is matching instrument locations in Google Earth.

Figure 5-64. WebIDP interface (USACE 2012b).

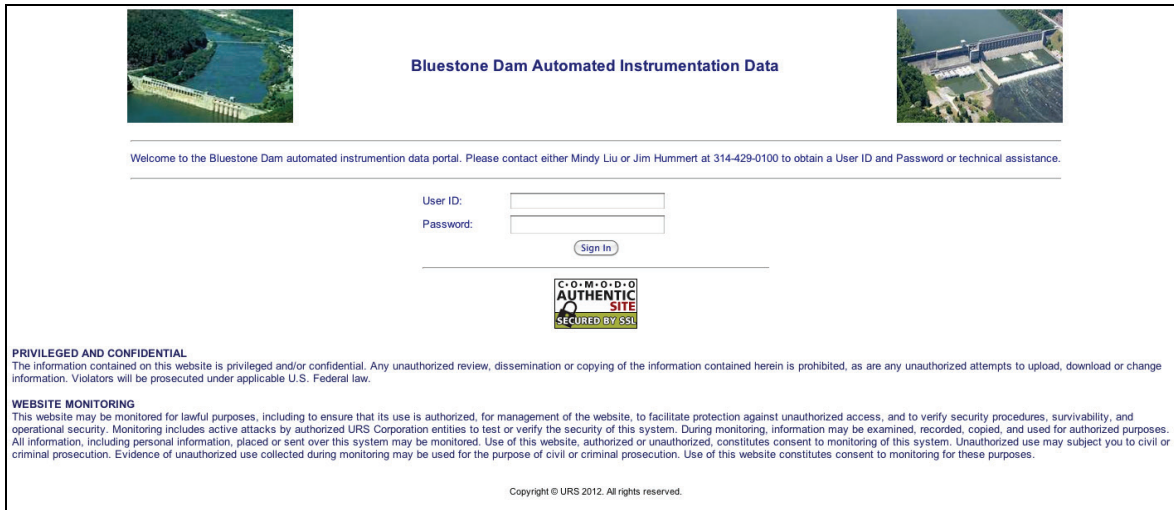


5.9.7 Portal sites

Intranet Project Portals are available to provide instrumentation databases and graphics for a project accessible from any browser. USACE projects that have created portals are Tuttle Creek Lake Dam, Wolf Creek Dam and Bluestone Dam (Figure 5-65). These portals were all created for the particular needs of each project. Some have the WebIDP features inside the portal and added other information, such as Earthquake and H&H-related links (e.g., USGS, NOAA, weather.gov), and additional documents (e.g., drawings, instrumentation plans, dam inspection reports, Emergency Action Plans). Some information can be interlinked to show alarm status based on sensor readings connected to the project's Emergency Action Plan. Trigger sirens and notifications will be sent to responsible parties when

programmed sensor values are measured. Automatically-generated plots using the most recent data are useful tools for effective monitoring.

Figure 5-65. Example project portal site for Bluestone Dam (URS 2013).



Bluestone Dam Automated Instrumentation Data

Welcome to the Bluestone Dam automated instrumentation data portal. Please contact either Mindy Liu or Jim Hummert at 314-429-0100 to obtain a User ID and Password or technical assistance.

User ID:

Password:

**C-O-M-O-D-O
AUTHENTIC
SITE
SECURED BY SSL**

PRIVILEGED AND CONFIDENTIAL
The information contained on this website is privileged and/or confidential. Any unauthorized review, dissemination or copying of the information contained herein is prohibited, as are any unauthorized attempts to upload, download or change information. Violators will be prosecuted under applicable U.S. Federal law.

WEBSITE MONITORING
This website may be monitored for lawful purposes, including to ensure that its use is authorized, for management of the website, to facilitate protection against unauthorized access, and to verify security procedures, survivability, and operational security. Monitoring includes active attacks by authorized URS Corporation entities to test or verify the security of this system. During monitoring, information may be examined, recorded, copied, and used for authorized purposes. All information, including personal information, placed or sent over this system may be monitored. Use of this website, authorized or unauthorized, constitutes consent to monitoring of this system. Unauthorized use may subject you to civil or criminal prosecution. Evidence of unauthorized use collected during monitoring may be used for the purpose of civil or criminal prosecution. Use of this website constitutes consent to monitoring for these purposes.

Copyright © URS 2012. All rights reserved.

Instruments or setups that are not normally compatible with WinIDP (e.g., IP Based Wireless Digital Video Camera feeds) can be added to the Project Portals to allow access to these devices. Tuttle Creek Dam's Intranet Portal is an example where a monitoring system uses available site instrumentation and combines it with video surveillance and LED Embankment Alignment Indicators (URS 2012), which are not directly compatible with WinIDP. Many portals have a similar setup, where non-WinIDP compatible instruments are used in combination with WinIDP and geotechnical instruments to show recent data and allow for alarm monitoring.

5.9.8 Commentaries and limitations on WinIDP/WebIDP and portals

WinIDP, like any software, has limitations. Although in some cases WinIDP may be sufficient for the application the user anticipates, it may need modification to fit certain instrumentation applications. The DLIC recommended it as a software package because of its flexibility to be modified for the many USACE projects involved. Limitations can be subjective, experience related, software familiarization, or hardware related.

The flexibility of the software was evaluated by creating a project. The workflow is basically menu-driven, and it can be easily followed using the tutorial. The workflow provides great flexibility from defining and

configuring the Instrumentation Types and Instrumentation IDs through obtaining the reports and plots. The initial configuration is time consuming and contains many steps in the process. However, the configuration only needs to be done once for every instrument and should only need minor modifications for future updates.

There are many reporting and plotting tools that allow flexibility on how the data are displayed. This added flexibility eliminates the need for standardized requirements and may create confusion to some users on how data should be presented and displayed. Districts have templates, which make it easier for users to adapt to their projects using standardized displays. This approach can improve the way data are presented, based on the requirements of a requesting organization.

When working with any network instrumentation databases and ADAS, problems likely will occur due to network issues and linking the databases to the software. This condition is generally the issue for any database management software. Access to the data by the software is required. The software requires access to the database and being able to receive the data in real-time from the field. Thus, there should be database backups, administrator support, and ensured network reliability.

A minor limitation of the software is dependency on external programs for plotting and reporting. External applications are standard commercial software users typically have installed on their computers. These external programs provide the desired flexibility and format users require. However, it must be acknowledged that network limitation of these external applications will limit WinIDP's capabilities. The software should have integrated internal plotting capabilities similar to WebIDP.

Instrument definitions are often redefined and cause older data to be modified. The result of any sensor changes can affect the outcome of older data and requires these data to be verified and corrected, some as a result from typographical errors. The software does not have a time-stamped log to track changes made. This feature could be a future change and addition to aid in QA/QC.

The WebIDP version allows a great mirror image capability of the desktop-based version with the flexibility of user access through the WebIDP portal. Although it has less dependency on external software, it does not

provide full capability as the desktop version. Thus, WebIDP is actually considered as being in a secondary role to WinIDP. The author supports having a Web-based and desktop-based system with the same interface. This comparability makes the user feel more familiar with the system.

Some of the features available in DamSmart are not available in WinIDP because of network compliance issues. Smartphones and handheld data loggers with access to WinIDP would be ideal because they make entering and accessing data much easier. The use of Project Portals adds great functionality where WinIDP/WebIDP may be limited. Historically, the software has focused on only particular projects, rather than at a national perspective. Ideally, a USACE-wide portal would encompass all USACE divisions, districts and all projects where instrumentation is available. This larger perspective would make it easier to verify site correlations and improve the state-of-the-practice.

In summary, the author's experience on using the WinIDP software showed a powerful tool for managing sensor data and showed minor limitations involving ease of incorporation portable devices and secure network issues exist, but no software will have all the features desired. There will always be limitations with any package and next generation issues. The recommendation of WinIDP as the instrumentation package for USACE underscores the importance of managing sensor data.

5.9.9 Other instrumentation software

Other software packages that have been developed are identified. These packages include desktop and Web-based software. The USBR has developed their own in-house software called the Data Acquisition and Management System (DAMS), which employs no commercial software for any of its capabilities. Similarly within USACE, the Fort Worth District developed their own software package called the Dam Safety Instrumentation (DSI), and the Nashville District for Wolf Creek Dam has developed their own GIS-based Website. A great variety of packages exist commercially, each having their own advantages, which should be thoroughly examined. Some of the commercial manufacturers offering Web-based software are:

- Canary's MultiLogger Suite- <http://www.canarysystems.com/>
- Geocomp's iSite Central- http://www.geocomp.com/field_systems.asp
- Keynetix' Monitoringpoint.com- <http://www.monitoringpoint.com/>

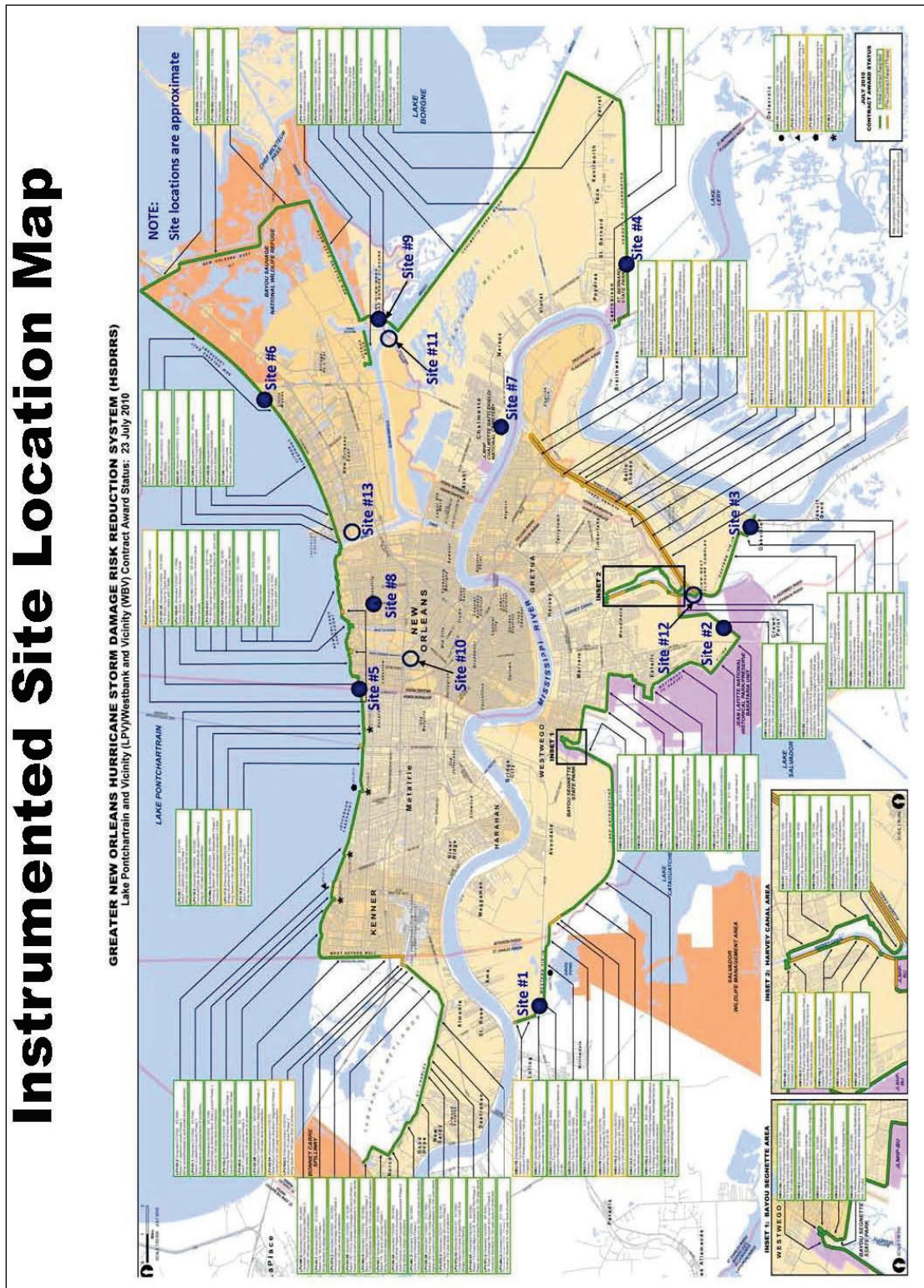
- Maxwell Geosystems' INSITE- <http://www.maxwellgeosystems.com/>
- Vista Data Vision's Data Analysis Software- <http://vistadatavision.com/>
- Itmsoil's ARGUS- <http://www.itmsoil.com/pages/argus+monitoring+software>
- RST's GeoViewer- <http://www.rstinstruments.com/GeoViewer%20Real-Time%20Monitoring.html>
- Soldata's Geoscope- <http://www.soldatagroup.com/solfrey/i.nsf/pages/geoscope-system.DF594A1BDF8B259CC12579D000490A25>
- Roctest's SHM- Live- <http://www.roctest-group.com/services/shmlive>
- DGSI's Atlas- <http://www.slopeindicator.com/atlas/atlas--service.html>

5.10 iLevee demonstration project

A technology demonstration project for monitoring the health of levees is being implemented by the state of Louisiana that bears further mention and discussion. The state of Louisiana, Office of Coastal Protection and Restoration (OCRP) has begun development of a state-of-the-art levee monitoring and alert system at selected locations in the greater New Orleans flood protection system (Brouillette 2012). This real-time levee monitoring system is believed to be the first of its kind in the United States for the sole purpose of monitoring levee health and to warn of undesirable performance. Real-time monitoring technology is routinely being used for large construction projects but has not been implemented in a levee system at a system-wide scale. The iLevee monitoring program involves a comprehensive suite of instruments and technologies to monitor movements, settlements, and deflections of concrete I-walls, T-walls, and earth embankments, as well as changes in groundwater pressures in pervious soil horizons (i.e., point bar and buried beach deposits).

A range of geotechnical and engineering companies are involved in the design, instrumentation, program management, data storage, fusion, communication, early warning, and GIS development. Companies involved in the system development include Geocomp Corporation (2013) (program management, system design, data fusion, Shannon and Wilson Inc. (instrumentation), Parson Brinkerhoff (program assessment, GIS), NIMSAT (2011) (GIS development) and Witt Associates (emergency response interfaces) (Brouillette 2012). The demonstration project for the monitoring system currently involves ten instrumented sites within the greater Orleans area in Jefferson, Orleans, Plaquemines, and St. Bernard parishes (Figure 5-66). Risk reduction measures were used to identify the instrumented levee locations.

Figure 5-66. iLevee monitoring demonstration sites (in blue text) by the Louisiana Office of Coastal Protection and Restoration (Brouillette 2012).



Highlights of several sites in the monitoring demonstration are summarized: (a) a section of levee with fiber optic cable to monitor strain displacements along the I-wall crest and at the toe of the rebuilt T-wall levee section at the 17th Street Canal failure (Site 5, near intersection of 17th Street Canal and Hammond Highway in Orleans Parish, Figure 5-67), (b) vibrating wire piezometers and in-place automated inclinometer sensors along a remote reach of the V-Line levee section with a soft soil foundation (Site 2 on the west bank (south side of Mississippi River) near Crown Point in Jefferson Parish, Figure 5-68), (c) extensometer, tiltmeter, and in-place inclinometers at the LPV48 T-Wall section along Bayou LaLoutre, east of the town of Poydras in St Bernard Parish (Site 4, Figure 5-69), and (d) shape acceleration arrays (SAA), extensometers, and piezometers at the London Avenue levee failure, near the Mirabeau Bridge (Site 8, Figure 5-70). Additionally, remote sensing technology is incorporated into the system design using InSAR to monitor changes in elevation for the levee system. Calibrated reflectors or targets have been placed on I-Walls and T-Walls to precisely measure any changes in elevation that may occur. The different sites within the greater New Orleans area involve various types of failure mechanisms that are being monitored using state-of-the-art technology. An understanding of the geology and the levee failure mechanisms that occurred during Hurricane Katrina were considered for instrument selection.

As shown by the selected photographs at these locations, the installation of this levee monitoring system involves a major financial commitment in terms of personnel, infrastructure (GPS, communication, power, data storage, network security, system-wide maintenance), and programming of the system architecture for the specialized levee condition/health display and the assessment tools to provide alerts and early warnings of unsatisfactory levee performance. The cost for the installation and development of the iLevee system is estimated to be \$3 million for the locations identified in Figure 5-66 and will involve nearly a year to implement the system-wide installation at these sites (Brouillette 2012). The system will be reevaluated after a year to determine the best path forward and evaluate lessons learned from the installation, data collection, and results obtained.

Figure 5-67. View of Site 5 monitoring system consisting of fiber optic sensor system for monitoring strain displacements at the levee toe and I-wall at the 17th Street Canal in New Orleans for the iLevee monitoring demonstration project (Brouillette 2012).



Figure 5-68. iLevee demonstration project at Site 2 on the V-line levee consisting of vibrating wire piezometers and in-place automated inclinometer (Brouillette 2012).



Figure 5-69. iLevee monitoring of T-wall for deflection and foundation movement using tiltmeters and in-place inclinometers at Site 4 on LPV48 levee, east of town of Poydras in St. Bernard Parish (Brouillette 2012).

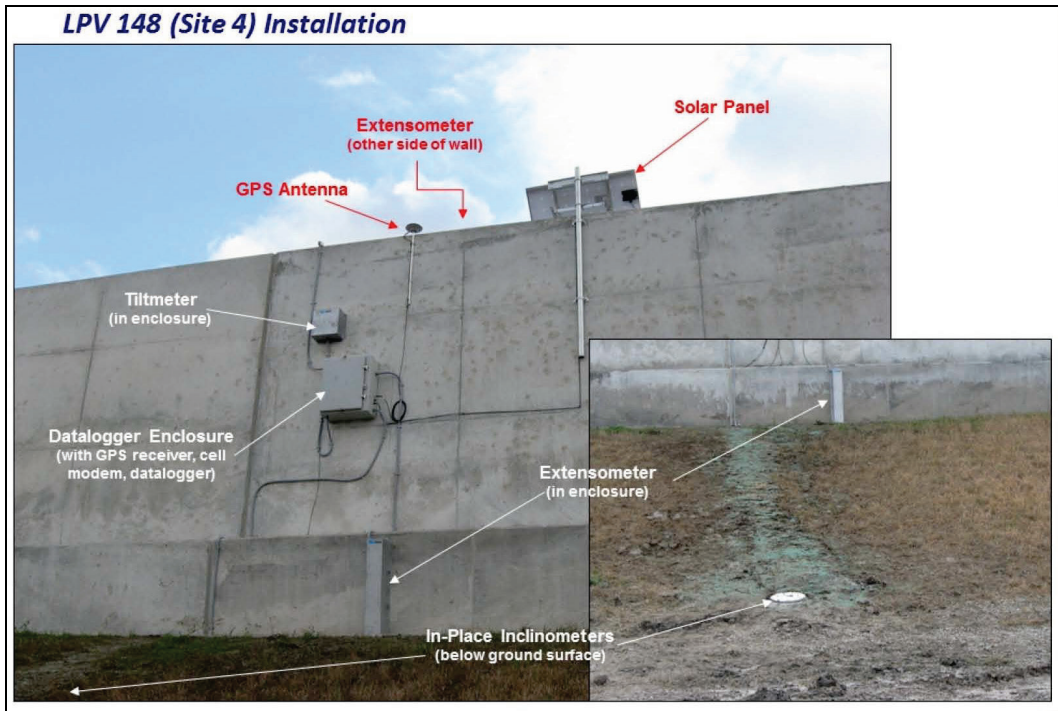


Figure 5-70. Monitoring at Site 8 at the site of the Hurricane Katrina Mirabeau levee breach on the London Avenue Canal. Monitoring technologies include piezometers in the canal and at levee toe, extensometers, GPS, InSAR reflector (see cross section), and ADAS system to log and transmit data (Brouillette 2012).



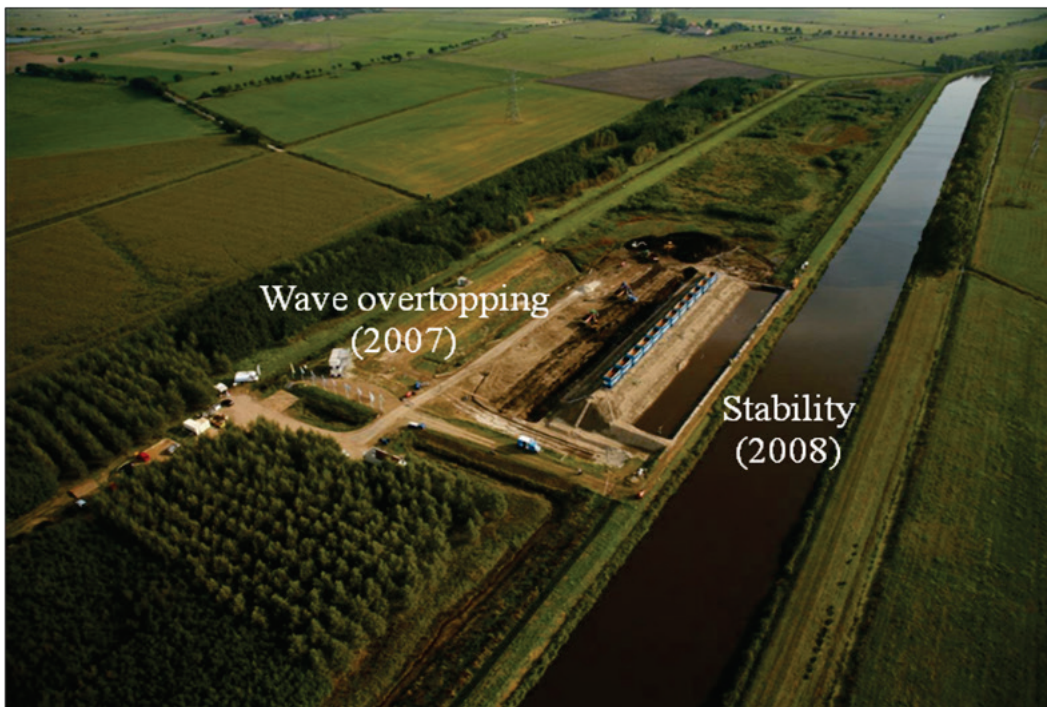
This path potentially provides critical information to better assess the validity of USACE's Interagency Performance Evaluation Task Force (IPET) reliability assessments of the flood protection system (Brouillette 2012). Additionally, the path forward could link to weather sensors, storm atlas, or storm-surge wave modeling data, camera sensors, and post storm-planning response, as well as other data assessment tools and methods (Brouillette 2012). The iLevee project is an important demonstration project that bears close monitoring and detailed study. This demonstration project encompasses a broad partnership of state, local levee boards, and leaders in instrumentation technology and integration for evaluating geotechnical problems associated with urban levee systems. USACE New Orleans District is not involved in the demonstration project other than permitting and oversight. The monitoring program is a state-sponsored and funded effort.

This project is considered unique for the United States as it encompasses the means to accurately observe changes in levee behavior and performance from a long-term perspective. The system is capable of monitoring movements of the various structural members, changes in soil strength properties through time, groundwater conditions, and the soil structure interaction due to changes in loading. This system provides the capability to assess many of the assumptions involving the geotechnical properties at these different locations and provides a means to evaluate engineering design. When one considers the costs associated with flood-related damages from Hurricane Katrina (excess of \$100 billion), and the costs and time associated with rebuilding an urban flood protection system, a real-time monitoring capability is a small price to pay for the ability to monitor poor performance and identify locations where actions need to be taken to ensure public safety.

5.11 IJkdijk (live dike) test site experiments, Netherlands

Dutch researchers have been conducting studies of instrumented levees to increase the knowledge on levee behavior and to develop new sensor technologies for early warning of flood performance at the Booneschans test site in the Netherlands (De Vries et al. 2010; Koelewijn 2009, 2012; van Beek et al. 2010). Research efforts at the IJkdijk dike facility have involved more than 40 different companies and institutions from five different countries and included experiments in piping, wave overtopping, and stability over a 3-year period (Figure 5-71).

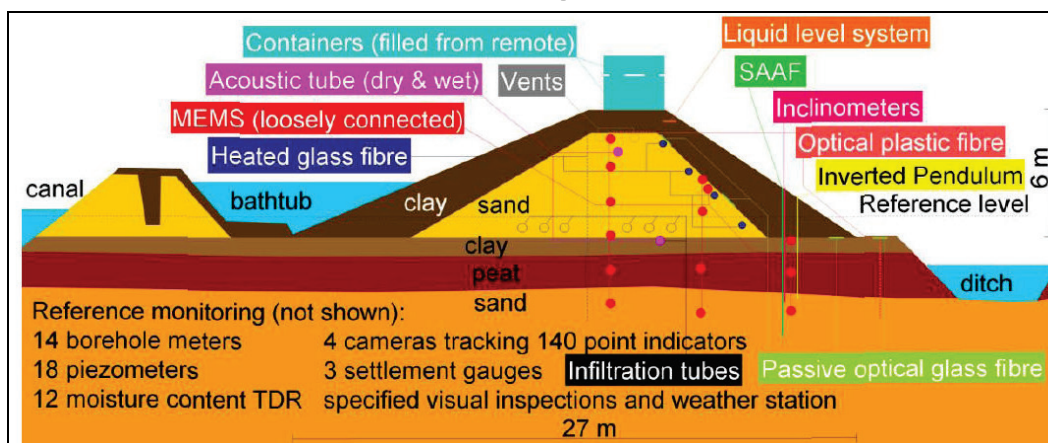
Figure 5-71. Aerial view of IJkdijk test facility and the types of levee failure experiments conducted at this site (Koelewijn 2009, 2012).



Seepage and piping are considered especially important failure mechanisms for Dutch levees (De Vries et al. 2010; van Beek et al. 2010, 2011). Two large basins containing different sand gradations (d_{50} of 150 μm and 210 μm) were built in 2009 to test seepage beneath a 3.5-m clay levee. Instrument testing involved measurement of deformations, vibrations, temperature by glass and plastic fiber optics, dynamic imaging by acoustics, water leakage from self potential, deformation with infrared cameras, pore pressure, tilt, and temperature from transducers integrated with MEMS technology (De Vries et al. 2010). Results of the seepage and piping experiments in 2009 indicate temperature monitoring was an effective technique during the progressive erosion phase with levee failure process consisting of seven distinct stages: (1) heave, (2) seepage, (3) pipe-formation, (4) pipe progression, (5) progressive erosion, (6) levee instability, and (7) breakthrough (De Vries et al. 2010). Optical sensing technology was found to be more effective in the sand layer, especially near the top of the layer because of the higher permeability contrast in comparison to the clay. Use of distributed fiber optical cable for sensing permits monitoring along the entire downstream reach being tested as compared to point sensors.

For the loading test conducted in 2008, a host of different instruments were used to monitor loading of the levee (Figure 5-71). The levee test section was designed with a height of 6 m, length of 100 m and base width of 27 m, crest width of 3 m, and side slopes of 1V:1.5H (Figure 5-72). The levee core was sand with a clay cover and a clay, peat, and sand foundation. Instrumentation included acoustic measurements, optical detection using three different fiber methods, MEMS technology, thermographic cameras, LiDAR, and three different systems for traditional pore pressure, and humidity (Koelewijn 2009). Testing was also conducted on decision-making software (i.e., Flood Control 2015, 2013a, 2013b; Simm et al. 2013) to access real-time monitoring for evacuation if poor performance is detected. Details of the test program are further described by Koelewijn (2009). Lessons learned from these tests will be incorporated into a IJkdijk experiment 50 km northwest of the test site at Eemshaven for purposes of monitoring and developing early effective warning technology (Simm et al. 2013).

Figure 5-72. Cross section of the test levee and foundation and the instrumentation incorporated into the IJkdijk loading experiment (Koelewijn 2009).



5.12 Summary

The goal of this chapter review was to assess current and future trends in remote monitoring technology for geotechnical structures during extreme loading events. Advances in the field of remote monitoring in geotechnical engineering are the result of advances in electronics and telecommunications during the past 20 years. Material presented in this chapter includes instrumentation systems capable of automatically monitoring both surface and subsurface ground movements, groundwater pressure, and seismic events.

The current direction in terms of surface monitoring involves LiDAR-based methods. Properly designed LIDAR systems are capable of monitoring both horizontal and vertical displacements, and settlements involving the ground surface. Many of the technologies are newly developed and have been used on a limited basis. The major limitations of these instruments are long-term data management issues and cost to obtain these capabilities. Data reduction costs can be overcome with experience and smart software applications that automate the visualization process. For example, perhaps a good starting point would be to use new tools and instruments in a test section or technology evaluation project (i.e., dam and/or levee).

Other promising technology involves MEMS and fiber optic technology for in-place inclinometer systems used for monitoring slope movements or settlements. Inclinometer systems are currently capable of retrieving data on command from a remote location and sending this information to the office, using cell phone and Ethernet technology. Real-time alerts are

capable of being sent when important threshold events occur. This technology is readily affordable and improves public safety.

Remote monitoring of dams and levees during flood events provides valuable information about system performance, both during the event and afterward. This information helps reduce risk and identifies any areas of concern for poor performance during the life of the structure. With any instrumentation program, it is extremely important to only place instruments in critical areas to answer specific questions about failure mechanisms and specific parameters where data are required.

The use of remote instrumentation systems enables engineers to collect geotechnical data at appropriate times before, during, and after a significant loading event for better understanding of system performance and design. Compared to manual systems where data are collected at irregular time intervals (or even not at all), the remote systems allow for a more accurate picture of the structure and design assumptions. A discrete (or manual) method of data collection gives data points at a set interval, weekly, or monthly (or irregular). The automatic method provides data at a much finer resolution and captures the loading events and system response.

Targeted studies of USACE instrumentation performance are needed. Information from case histories can provide important lessons learned, especially those involving major projects like Wolf Creek Dam. A database of sensor performance needs to be compiled for a region (district-wide) and USACE perspective (division and nationwide level). Future investigations could involve a “best practices” type manual of state-of-practice that would be useful to the entire Corps’ geotechnical community.

6 Noninvasive Methods for Levee and Levee Foundation Investigations

6.1 Introduction

This chapter describes several noninvasive methods that are used to investigate anomalous conditions within levees and their foundation. The objective of this section is to provide the reader with an overview of applicable noninvasive methods, along with their respective survey method, the information the methods provide, how the methods are applied in a levee investigation, and their limitations. This information will allow project managers to make a better informed choice in selecting an appropriate noninvasive method for a specific project.

Subsurface geophysical methods can be broadly characterized as an attempt to “see” beneath the ground surface in a nondestructive and nonintrusive manner (without digging the ground up). Soils have naturally occurring physical properties and the measurement of these naturally occurring properties may be considered the background readings or “normal” readings for a given area. In reality, what the geophysical instrument detects are significant changes (anomalies) in one of these naturally occurring physical parameters. One of the primary tasks of the geophysical professional is to select the most effective geophysical method for the site given its native conditions. It is important to emphasize that while a variety of geophysical methods are available, not all are applicable for every ground condition.

Noninvasive methods, especially geophysical methods, have been successfully used for many years at embankment dams and levees for delineating seepage paths and monitoring anomalous seepage areas, locating possible areas of internal erosion (cavity/void detection), mapping lithology, determining in situ elastic moduli, mapping buried alluvial channels, and locating unmapped buried utilities or objects near or within the levee. In addition to flood-control works, geophysics has been used for highway studies (U.S. Department of Transportation 2013). Unlike invasive methods, such as drilling, that is expensive and provides information at a single point (one-dimensional or 1-D), noninvasive surface methods can provide more complex 2-D and 3-D images of the subsurface.

It is imperative that areas having deficient geologic features be identified in the earliest stages of a levee condition assessment so that other exploratory methods can be used to confirm their existence and map their distribution. Knowledge of fluvial processes and the ability to recognize depositional environments in the geologic record are the key to identifying locations along modern levees where underseepage has the greatest potential to occur. To gain additional information about the foundation materials, borings are usually placed at predetermined distances, sometimes hundreds of meters apart, along the levee axis and toe. Through the performance of Standard Penetration Testing (SPT), during the drilling of borings, and with laboratory testing of soil samples, engineering soil properties as a function of depth at a given boring location are obtained. However, soils information between borings must be interpolated. In some geologic conditions, where there are gradual or rather predictable soil changes, the interpolations may be adequate. In areas where the geology is more complex, interpolating the soil properties or conditions between borings may not be adequate. In the case of a geologically complex site, many more closely-spaced borings would have to be placed to define the subsurface conditions with sufficient detail for meaningful engineering judgment. In this situation, it may not be feasible to place the required number of closely-spaced borings because of time and/or monetary constraints.

Surface geophysical testing can be conducted between widely-spaced borings, as an alternative to drilling closely-spaced borings, to provide cost-effective geologic information. In 2003, ERDC personnel conducted a study to determine the feasibility of using noninvasive geophysical methods to assess the levees along the U.S. International Boundary and Water Commission levees in the Middle and Lower Rio Grande Valleys (Dunbar et al. 2003, 2004). The study consisted of first conducting helicopter-borne LiDAR EM and magnetic (MAG) surveys along the levees to obtain an overall assessment of soil conditions of the levees and their foundation. Anomalous areas were identified from the helicopter-borne surveys and investigated in greater detail using ground-based geophysical surveys, a cone penetrometer equipped with an electrical resistivity probe, and soil sampling using conventional borings. The study concluded that the LiDAR, EM, and MAG surveys were an economical and reliable method for assessing the soil composition and condition of levees and their foundations along the levee right-of-way.

One of the main differences in conducting a geophysical investigation along a levee versus at a dam site is the matter of survey scale. Investigations at a dam site are quite limited in scale relative to a levee investigation, where coverage may range from a small, single problem area to hundreds of miles in great extent. It is possible to conduct a detailed investigation at a dam or a small section of levee. However, the same degree of detail is not practical or even possible along miles of levee reaches. When a large number of levee miles are to be investigated, a preliminary reconnaissance survey is suggested to locate anomalous areas that can be studied in more detail and with greater accuracy.

A reconnaissance survey is intended to examine all or part of an area in sufficient detail to make generalizations about the subsurface conditions within a given project area. As geophysical reconnaissance survey is a type of field survey that is often used to gather initial information regarding the general geophysical characteristics within a project area. Reconnaissance surveys generally include airborne or ground-towed geophysical methods. The choice of reconnaissance method is usually based on budget, site accessibility, and amount of area to be surveyed. These methods are usually rapidly executed and are relatively low cost (Table 6-1). These surveys provide information regarding the presence or absence of anomalous geophysical conditions (signatures) and aid in determining which areas, if any, require resurveying in greater detail or targeted drilling and soil sampling.

Objectives of a noninvasive investigation are to characterize an area of interest that can include delineating areas of anomalous or uncontrolled seepage, locating potential voids or areas of internal erosion, delineating the soil/bedrock contact, revealing the location of paleochannels, identifying potentially liquefiable zones in the foundation, or locating suspected or lost pipes, conduits, or other buried utilities. The performance of an investigation for this purpose is usually a one-time undertaking.

Long-term monitoring can also be accomplished using noninvasive methods. Monitoring consists of repeating surveys in the same area over a period of time to assess changes in site conditions. Monitoring allows unsafe changes in site conditions to be discovered early enough to allow personnel to take the necessary steps to prevent a catastrophic failure.

Table 6-1. Reconnaissance methods.

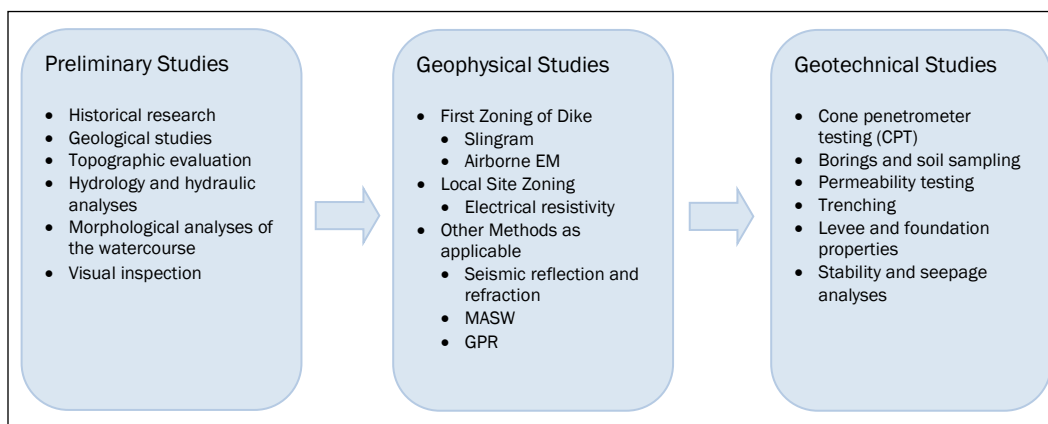
Method	Principle	Reconnaissance Method		Detailed	Use
		Airborne	Ground-Towed		
Magnetics (MAG)	Measures variations in the earth's local magnetic field	Yes	Yes	Yes	Detecting and mapping buried ferrous objects near or penetrating the levee
Seismic	Analyzes the velocity and character of seismic waves induced into the ground	No	Yes	Yes	Stratigraphic profiling or mapping, water table mapping, elastic moduli, fault and fracture mapping, seismic velocities, N-value
Electrical Resistivity (ER)	Measures variations in electrical current induced into the subsurface	No	Yes ^a	Yes	Seepage detection and mapping, stratigraphic profiling or mapping, fault and fracture mapping, void detection
Electromagnetic (EM) Induction	Measures variations of magnetic field induced into the subsurface	Yes	Yes	Yes	Seepage detection and mapping, stratigraphic profiling or mapping, fault and fracture mapping, void detection, metal detection
LiDAR	Measures distance to target for elevation maps	Yes	Yes	Yes	Detailed topographic base maps and cross-section profiles of elevation

^a Capacitive coupled resistivity system.

6.2 Approach

A common sense approach to conducting a levee assessment using geophysical methods is described by Royet et al. (2012) that involves three basic steps (Table 6-2). The first step in the process involves preliminary studies using historical research, geological study, assessment of topography, hydrology and hydraulics, morphodynamic analysis of the watercourse, and visual inspection. The results of these initial studies would lead to geophysical surveys of problem areas in step two for purposes of general levee/dike zoning, and/or followed by focused local zoning of anomalous levee/dike areas. A variety of different geophysical methods are identified, depending on the nature of the problem to be solved (see Tables 6-1 and 6-2). EM and/or airborne EM (AEM) methods are favored for initial investigative purposes of general levee/dike zoning. Electrical resistivity surveys are the preferred method used for localized studies involving detailed inspection and site characterization. Other geophysical methods are applicable in this systematic and targeted approach to characterizing the levee/dike stratigraphy and associated properties. Methods identified include GPR, seismic, and/or MASW methods depending on survey objectives, site stratigraphy, and targets to be resolved. The last step in this systematic evaluation process involves geotechnical studies that consist of traditional borings, CPTs, trench excavations, permeability testing of stratigraphic horizons, and traditional engineering evaluations for slope stability and seepage.

Table 6-2. Approach to conducting geophysical surveys of levees/dikes (Royet et al. 2012).



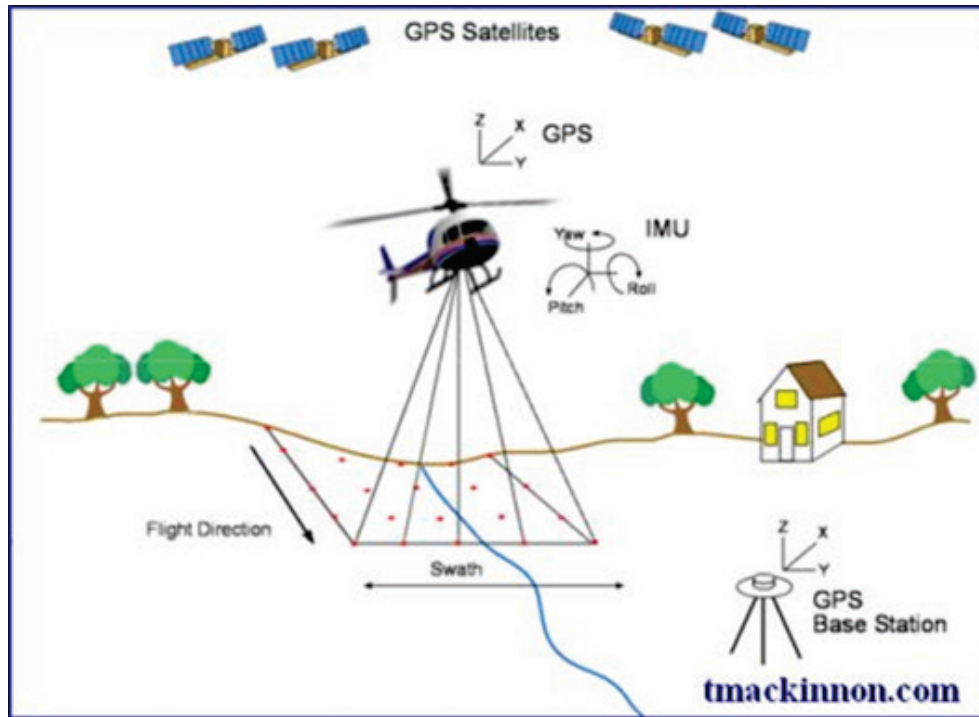
This basic approach has been traditionally favored for the investigation of dams, especially those experiencing performance issues. The use of geophysical methods in conjunction with traditional boring programs is becoming more common in the study of levee performance issues in the United States (Casas et al. 2012; Dunbar et al. 2003, 2004; Llopis and Simms 2007; URS 2009). Historically, levee foundation geology has been poorly characterized and not well understood in the majority of post-flood performance issues without further study, especially in urban areas where the floodplain setting has been significantly altered.

6.3 LiDAR

LiDAR is an optical remote-sensing technique that uses laser light to densely sample the surface of the earth, producing highly accurate x, y, z measurements. LiDAR is primarily used in airborne mapping applications. LiDAR systems are uniquely suited to low altitude, high accuracy surveys.

LiDAR data are collected using a laser scanner that is usually mounted on an aircraft but may also be mounted on a ground vehicle, boat, or at a fixed position. Laser light is transmitted to a target and the time of the returned reflected light is accurately measured. Combined with the positional information from a GPS and an inertial navigation system (INS), these distance measurements are transformed to measurements of actual 3-D points of the reflective target (Figure 6-1). As many as 50,000 points can be collected every second (Raber and Cannistra 2005).

Figure 6-1. Illustration of the LiDAR concept.



High-resolution digital elevation maps generated by airborne and stationary LiDAR provide the ability to detect subtle topographic features such as river terraces and river channel banks. Repeat surveys or monitoring can detect changes in a levee's elevation, erosional features, or slope shape. An additional feature of LiDAR is its ability to “strip-off” vegetative cover to allow the “bare earth” surface elevation to be mapped. This capability is possible as long as there is a path through the branches and leaves in which the light can reach the ground surface and provide a return signal.

One factor affecting LiDAR accuracy is the sudden positional changes of the aircraft because of being buffeted by wind, or there is a sudden change in atmospheric pressure resulting in a rapid drop or rise in aircraft position occurring between GPS epochs. This condition can cause havoc with GPS positioning and inertial systems. Obviously, the faster the aircraft is travelling the worse the effect.

6.4 Electromagnetic method

EM induction is used to measure the apparent electrical conductivity (inverse of electrical resistivity) of subsurface materials and detecting buried metallic objects. Electrical conductivity is a measure of the degree to which the soil conducts an electrical current. EM induction levee surveys are commonly used to map the conductivity of the underlying

soils. Because the measured electrical conductivity correlates strongly with soil properties, EM is a useful tool for mapping sand and gravel aquifers, aquatards, conductive leachate plumes in groundwater, saltwater intrusion, site stratigraphy, identifying major geologic features (e.g., depth to bedrock), and/or detecting anomalies such as voids, buried utilities, and other man-made structures. EM surveys can be conducted either from airborne or ground-based platforms (Dunbar et al. 2003). Figure 6-2 shows a helicopter towing an EM “bird.”

EM induction instruments operate in either the time- or frequency-domain mode. Frequency-domain instruments generally consist of a transmitter (Tx) coil and a set of co-planar receiver (Rx) coils separated a fixed distance apart. An alternating current is passed through the Tx coil, thus generating a primary time varying magnetic field. This primary magnetic field induces electrical currents in subsurface conductive materials. The induced electrical currents are the source of a secondary magnetic field, which is detected along with the primary magnetic field by the Rx coil.

Figure 6-2. An airborne EM survey being conducted showing the towed EM “bird.”

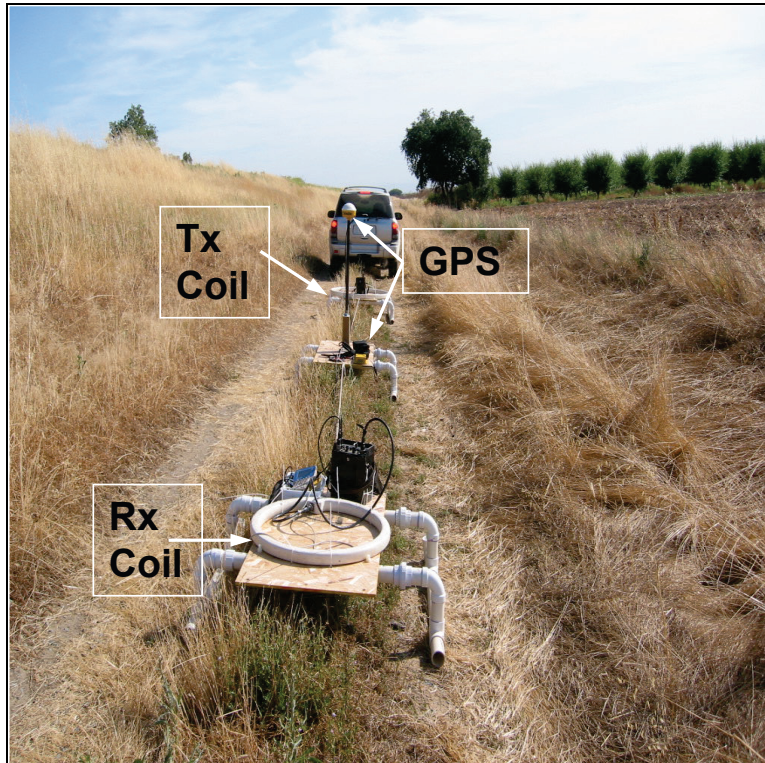


Two components of the induced magnetic field are measured by the EM system. The first is the quadrature phase, sometimes referred to as the out-of-phase or imaginary component. Apparent ground terrain conductivity is

determined from the quadrature component. Disturbances in the sub-surface caused by variable soil compaction, in-filled abandoned channels, soil removal and fill activities, buried objects, or voids may produce conductivity readings different from background values, thus indicating anomalous areas. The units of apparent ground conductivity are measured in milliSiemens per meter (mS/m). The in-phase component is sensitive to metallic objects and therefore, is useful when looking for buried metal such as metal pipes and electrical wires. When measuring the in-phase component, the true zero level is not known because the reference level is arbitrarily set by the operator. Therefore, measurements collected in this mode are relative to an arbitrary reference level and have units of parts per thousand (ppt).

Two commonly used ground-based EM instruments applicable for levee investigations are the Geonics EM31 (Figure 6-3) and EM34. The EM31 has a Tx-Rx coil separation that is fixed at 3 m. The EM31 meter reading is a weighted average of the earth's conductivity (apparent conductivity). A thorough investigation to a depth of about 3.5 m (12 ft) is usually possible.

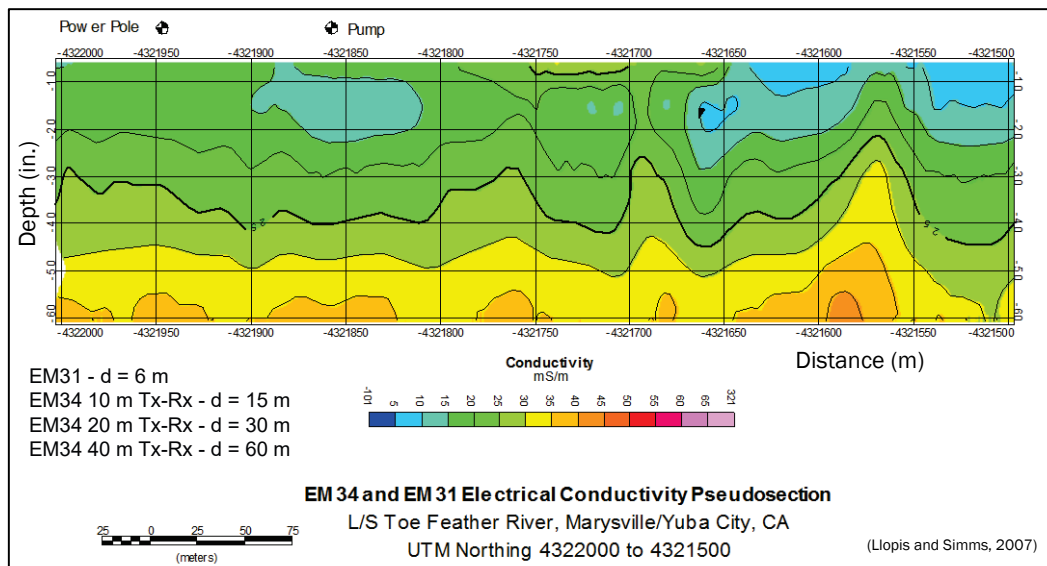
Figure 6-3. Vehicle-towed Geonics EM34.



The Geonics EM34 has Tx-Rx coil separations of 10, 20, and 30 m. When the rigid coils are placed flat on the ground surface (vertical dipole mode)

the depth of investigation is about 1.5 times the coil separation. If the coils are placed on the ground on edge and co-planar (horizontal dipole mode) the depth of investigation is about 0.75 times the coil separation (McNeill 1980). The combination of the three different coil separations and the two dipole modes allow for apparent conductivity values from six different depths of investigation to be collected at a given location. Apparent conductivity information collected at a single location is called a vertical electrical sounding (Figure 2-6). Vertical electrical soundings provide electrical resistivity values as a function of depth and are analogous to borehole electric logs. The apparent conductivity measurement is the average conductivity of one or more layers in the ground in the proximity of the instrument to a depth of investigation dependent on the coil spacing, orientation, operating frequency of the instrument. A 2-D conductivity profile of the subsurface can also be produced by collecting a series of closely-spaced soundings and converting the values of apparent resistivity using an inversion computer program. Figure 6-3 shows an EM34 being towed, on specially designed nonconductive sleds, along the toe of a levee and programmed to collect data approximately every 0.50 m along the survey line. Figure 6-4 shows the results of towed EM31 and EM34 survey along a levee toe. Those areas shown in Figure 6-4 with conductivity values of less than 15 mS/m are interpreted to consist of sands and gravels.

Figure 6-4. Towed EM31 and EM34 apparent conductivity results (Llopis and Simms 2007).



Unlike frequency-domain EM instruments, which apply a continuous alternating current to a coil and measure the secondary magnetic field while the transmitter is operating, time-domain (TDEM) or transient EM instruments generate a pulsed primary magnetic field to induce an electrical current into the ground. These electrical currents induce secondary magnetic fields. The magnitude and rate of decay of the secondary currents depend on the conductivity and geometry of the underlying soil. The EM receiver coil measures the decaying magnetic fields created by those secondary currents.

Measured values of the secondary magnetic field are made at discrete time intervals or “time gates” after the primary inducing pulse is turned off. These time gates typically range from a few microseconds up to tens or even hundreds of milliseconds after the transmitter current has been turned off, depending on the desired depth of exploration, which may range from approximately 3 to 100s of meters. Because measurements are made while the transmitter current is turned off, more sensitive measurements of the secondary magnetic field can be made.

Ground-based TDEM surveys are conducted by laying out Tx and Rx large wire loops on the ground surface. The Rx coil can be located within or outside the Tx coil. In an airborne survey, the Tx and Rx coils may be flown using a helicopter or airplane using several towed configurations. The advantages to conducting an airborne over a ground-based TDEM survey are that much more information can be collected in less time and site access is less of an issue.

Commercial software programs are available to convert the survey results of receiver signals into values of apparent resistivity. The parameters used in the program include Tx and Rx loop dimensions, transmitter current, and the Rx loop location relative to the Tx coil. These apparent resistivity values are used with the aid of an inversion computer program to generate vertical electrical soundings (Figures 2-9 and 6-4). In the case of airborne TDEM surveys, where sounding data are collected relatively close together, 1-D vertical electrical soundings can be stitched together to produce a 2-D slice of the subsurface.

A ground-based instrument that is commonly used for locating buried metallic objects is the Geonics EM61. The EM61 is a high-resolution, high-sensitivity, time-domain metal detector capable of detecting both ferrous

and non-ferrous metallic objects. To eliminate the effects of conductive soils, which have a shorter decay rate than those of metals, the secondary magnetic field response is not measured until a few microseconds after the transmitter is turned off. The EM61 is capable of detecting a single 55-gal drum at a depth of approximately 3 m (10 ft) beneath the instrument, yet is relatively insensitive to interference from nearby surface metal, such as fences, buildings, and cars (Geonics 2005).

The EM61 consists of two horizontal and parallel coils, each either 1.0 m by 0.5 m (0.3 ft by 0.2 ft) or 1.0 m by 1.0 m (0.3 ft by 0.3 ft) with one positioned approximately 0.5 m (20 in.) above the other and one approximately 0.40 m (16 in.) above the ground. Wheels are attached to the bottom coil so that the instrument can be hand-towed or towed behind a vehicle along a survey line. The measured signal is in units of millivolts (mV).

6.5 Magnetic surveys

Magnetic surveys measure changes in the earth's total magnetic field caused by variations in the magnetic mineral content of near-surface rocks and soils or ferrous objects. Ferrous material can include both man-made and natural sources. These variations are generally local in extent. The magnetic response is attributed both to induction by the magnetizing field and to remanent magnetization. Remanent magnetization is permanent magnetization and depends on both the thermal and magnetic histories of the body; it is independent of the field in which it is measured. Induced magnetization is temporary magnetization that disappears if the material is removed from the inducing field. Generally, the induced magnetization is parallel with and proportional to the inducing field.

Any material or object having a magnetic susceptibility will contribute to the total magnetic field measured by the magnetometer. If an object is present such that its magnetization is great enough to perturb the ambient magnetic field, then it will appear as an anomaly on the magnetic data plot. Man-made objects containing iron or steel are often highly magnetized and locally can cause large anomalies up to several thousands of nanoteslas. Magnetic data are customarily expressed in SI units as nanoteslas (nT) or in an older unit, gamma (γ): $1 \gamma = 1 \text{ nT} = 10^{-3} \mu\text{T}$. Except for local perturbations, the intensity of the Earth's field varies between about 25 and 80 μT over the conterminous United States.

Magnetic methods are generally used to map the location and size of ferrous objects. The size, orientation, depth of burial, magnetic susceptibility, and remanent magnetization of the object determine the magnitude of the anomaly and thus affect the ability of the magnetometer to detect the object. For a given susceptibility and remanent magnetization, as the size of the object decreases and/or depth of burial increases, the magnitude of the anomaly decreases; eventually the anomaly will be undetectable.

Sedimentary and alluvial sections will typically not show sufficient contrast such that magnetic measurements will be of use in mapping the geology because a lack of magnetic minerals. These minerals are common in volcanic and metamorphic regions in mountainous areas and tend to be concentrated in areas where streams have high gradients because of their higher specific gravity. However, objects that may be detected near or within a levee with a magnetometer include steel pipelines, reinforced concrete conduits, and buried trash assuming there is some ferrous material within it. Also, electrical cables may be detected because of the magnetic field induced by the electrical current.

Magnetic measurements are usually made with portable instruments along one or more lines. If a 2-D representation of the magnetic field is desired, then data are collected using multiple parallel lines that cover the survey area. The interval between measurement locations (stations) along the lines is usually less than the spacing between lines. Portable ground-based magnetometers can easily acquire data at a sampling rate of tens of readings per second whereas some airborne versions have sampling rates of up to 1,000 measurements per second. With an operator walking at a brisk pace and with the magnetometer set to a sampling rate of 10 samples per second, five to six magnetic data values can be acquired per meter.

To make accurate anomaly maps, temporal changes in the earth's field during the period of the survey must be considered. Normal changes during a day, sometimes called diurnal drift, are a few tens of nT, but changes of hundreds or thousands of nT may occur over a few hours during magnetic storms. During severe magnetic storms, which occur infrequently, magnetic surveys should not be made. The correction for diurnal drift can be made by repeat measurements of a base station at frequent intervals. The measurements at field stations are then corrected for temporal variations by assuming a linear change of the field between repeat base station readings. Continuously recording magnetometers can

also be used at fixed-base sites to monitor the temporal changes. If time is accurately recorded at both base site and field location, the field data can be corrected by subtraction of the variations at the base site.

Intense fields from man-made electromagnetic sources can be a problem in magnetic surveys. Most magnetometers are designed to operate in fairly intense 60-Hz and radio frequency fields. However, extremely low frequency fields caused by equipment using direct current or the switching of large alternating currents can be a problem. Pipelines carrying direct current for cathodic protection can be particularly troublesome or helpful if the goal is to locate these pipelines. Although some modern ground magnetometers have a sensitivity values of 0.1 nT or better, sources of cultural and geologic noise usually prevent full use of this sensitivity in ground measurements.

After all corrections have been made, magnetic survey data are usually displayed as individual profiles or as contour maps. Identification of anomalies caused by cultural features, such as railroads, pipelines, and bridges, is commonly made using field observations and maps showing such features.

6.6 Electrical resistivity surveys

As is the case with the EM method, electrical resistivity methods measure the bulk electrical resistivity of subsurface materials (Figure 2-6). Earth bulk materials are composed of solids (rocks and soil minerals), and voids (pores, cracks, fissures, fractures) that occupy the space between the solids. Major factors influencing the resistivity measurement are the amount of fractures and porosity of the material, the amount of pore fluid present, the salinity of the pore fluid, the presence of conductive minerals, and the interconnectivity of the pores and fractures. Table 6-3 gives the resistivity values of common rocks and soil materials. Resistivity values vary over several orders of magnitude depending on the type of earth material. Sedimentary rocks, because of their higher porosity and greater water content, have lower resistivity values than intact igneous and metamorphic rocks. Wet soils and groundwater have even lower resistivity values. Clayey soil normally has a lower resistivity than sandy soil (Reynolds 2011).

The resistivity of earth materials is determined by injecting current into the ground and measuring the resulting potential difference. Electrical resistivity geophysics covers a wide range of techniques determined by

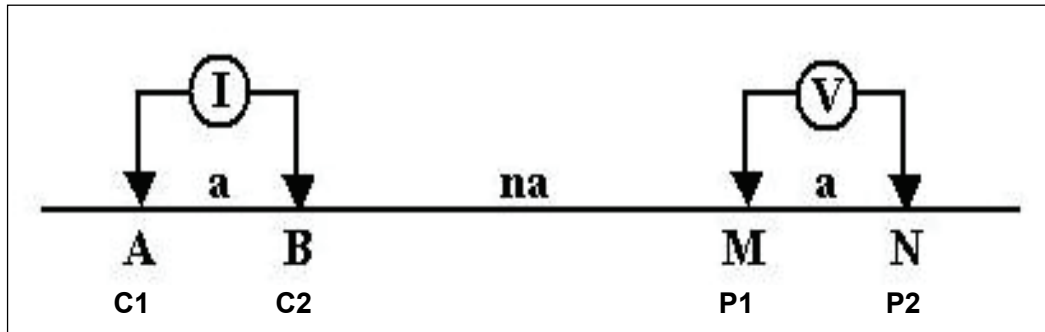
how the current is injected and how the data are collected and analyzed. For the purposes of characterization and monitoring dams and levees, the classic version of DC and capacitively coupled resistivity (CCR) are particularly pertinent and are reviewed here.

Table 6-3. Electrical resistivity values of some common rocks and minerals (Keller and Frischknecht 1966).

Material	Resistivity, $\Omega\text{-m}$	Conductivity, Siemen/m
Igneous and Metamorphic Rocks		
Granite	$5 \times 10^3 - 10^6$	$10^{-6} - 2 \times 10^4$
Basalt	$10^3 - 10^6$	$10^{-6} - 10^{-3}$
Slate	$6 \times 10^2 - 4 \times 10^7$	$2.5 \times 10^{-8} - 1.7 \times 10^{-3}$
Marble	$10^2 - 2.5 \times 10^8$	$4 \times 10^{-9} - 10^{-2}$
Quartzite	$10^2 - 2 \times 10^8$	$5 \times 10^{-9} - 10^{-2}$
Sedimentary Rocks		
Sandstone	$8 - 4 \times 10^3$	$2.5 \times 10^{-4} - 0.125$
Shale	$20 - 2 \times 10^3$	$5 \times 10^{-4} - 0.05$
Limestone	$50 - 4 \times 10^2$	$2.5 \times 10^{-3} - 0.02$
Soils and Waters		
Clay	1 - 1000	0.01 - 1
Alluvium	10 - 800	$1.25 \times 10^{-3} - 0.1$
Groundwater (fresh)	10 - 100	0.01 - 0.1
Sea water	0.2	5

An electrical resistivity survey is usually conducted using a linear array of four metal rods or electrodes in contact with the ground surface. Current is introduced into the ground using current electrodes (A and B in Figure 6-5) and the resultant potential difference, or voltage, between two other electrodes (M and N in Figure 6-5) is measured. The subsurface material acts as a natural resistor and a potential difference is generated across the two potential electrodes. Knowing the current injected into the ground, the electrode separation, and the potential difference, an apparent resistivity can be computed. The unit of electrical resistivity is the ohm-meter ($\Omega\text{-m}$).

Figure 6-5. Electrical resistivity electrode layout.



From the current and voltage values, an apparent resistivity value is calculated. The apparent resistivity value is an effective averaged resistivity over the total depth, but is not the true resistivity of the subsurface materials because the earth is non-homogeneous. The relationship between apparent and true resistivity is complex. An inversion algorithm is used to reconstruct the subsurface spatial distribution of electrical resistivity.

A limitation of the electrical resistivity method is that the measured reading at a given point is a weighted average of the effects over a large volume of material. This averaging process causes the detection or resolution of smaller targets to become more difficult as a function of depth. The distribution of resistivity readings on the ground surface can be accurately modeled given the number of layers, layer thicknesses, and layer resistivity values (forward modeling). However, the electrical resistivity inversion process (the process by which the distribution of subsurface resistivity values are determined) does not provide a unique interpretation. The more information known about the subsurface conditions (e.g., number of layers, layer thicknesses) can be input into the resistivity inversion computer program, the higher the confidence of the inversion results. The reason for having prior information about subsurface conditions, whether from borings or other geophysical exploration methods, is so important in forming a more accurate picture of the subsurface. A high degree of subsurface heterogeneity, large topographical gradients and very dry surface soils can influence the quality of the readings and affect interpretation results. High contact resistance problems occur when the near surface soils are so resistive (usually caused by extremely dry surface soil) that the current electrode has difficulty injecting current into the ground. In this case, saltwater is usually poured around the base of the electrodes to lower the electrode-soil contact resistance. Other factors that affect electrical resistivity surveys are the

presence of metallic fences, rails, pipes, or other soil-contacting conductors that could provide a short circuit path.

6.7 DC resistivity

DC resistivity surveys can be configured to provide 1-, 2-, or 3-D data. The 1-D or vertical electric sounding (VES) method involves increasing the electrode separations around a fixed midpoint, usually with a logarithmic electrode separation distribution (Figure 2-6). The VES method provides a vertical profile of resistivity versus depth comparable to a downhole electrical log obtained from a well. Horizontal electrical profiling, on the other hand, provides depth as well as lateral information and is therefore regarded to be 2-D method, which provides information on the soil profile beneath the survey line (Figure 6-6). Horizontal profiling is carried out by emplacing a number of steel electrodes into the ground at a specified interval along a survey line. A 3-D configuration, consisting of emplacing electrodes in a grid array, provides data in the x-, y-, and z-directions. Data are collected using computer-controlled data acquisition systems generally consisting of a resistivity instrument, a relay-switching unit, a computer, electrode cables, various connectors, and electrodes allowing for continuous collection of resistivity data in 2-D and 3-D configurations. Figure 6-7 shows an example of the results of a 3-D survey. The results show the distribution of resistivity values in the x-, y-, and z-directions.

Figure 6-6. An example of an electrical resistivity cross section 2-D plot.

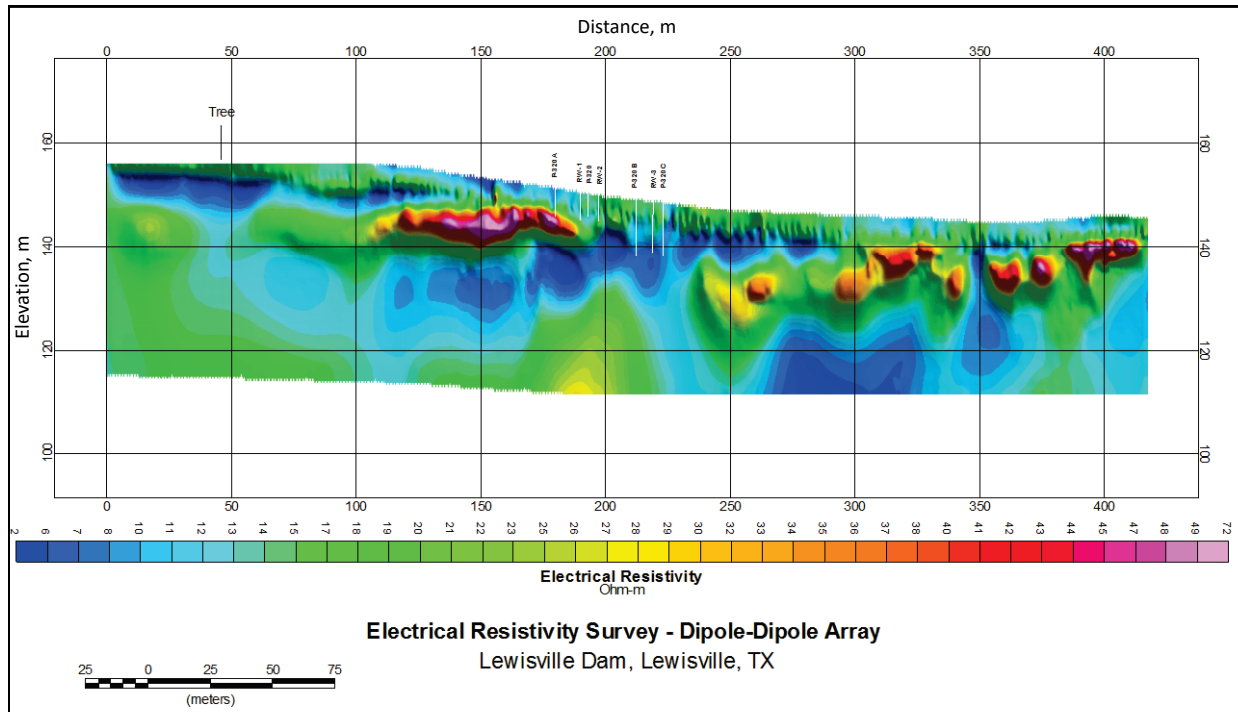
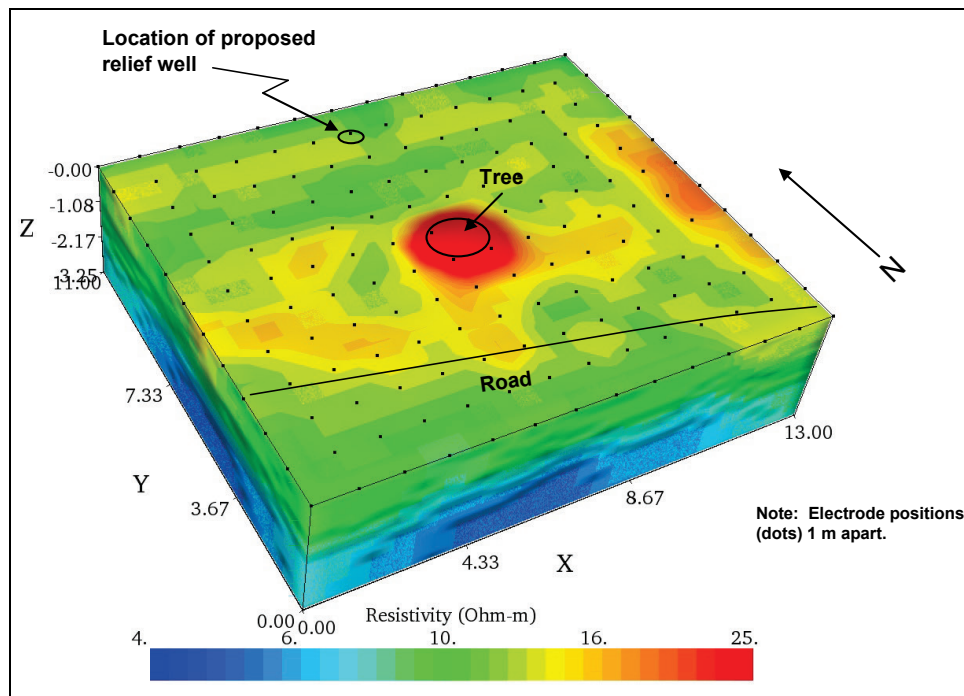


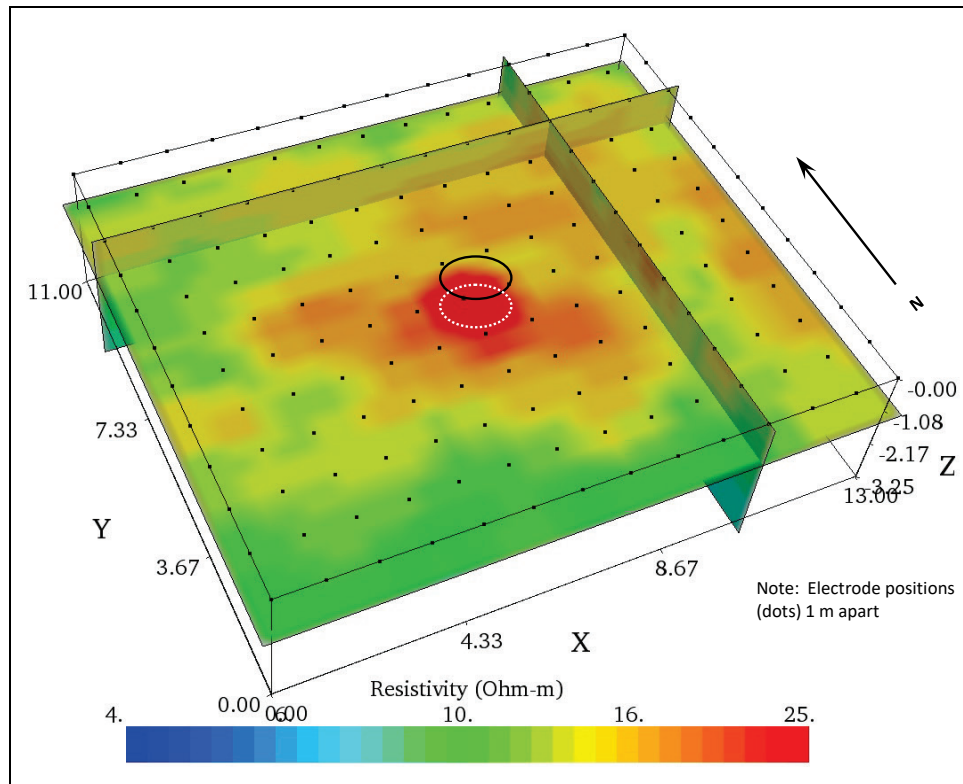
Figure 6-7. Example of results from a 3-D electrical resistivity survey.



In the surface-deployment method, the resolution is a function of practical electrode string length, numbers of electrodes, electrode separation, and position along the string. Data resolution decreases with depth of

penetration because of the greater volume of material being measured. More detailed near-surface information, as well as deeper penetration, is provided from the data collected near the center of the array. Figure 6-8 shows how the results can be examined with slices taken along the x-, y-, and z-planes.

Figure 6-8. Example of results from a 3-D electrical resistivity survey showing slices taken along the x,y,z planes.



6.8 Capacitively coupled resistivity (CCR)

An instrument using the CCR principle of operation is also used to collect soil conductivity information. The CCR principle of operation is similar to the DC resistivity method. Instead of using metal electrodes that have to be hammered into the ground as a means to inject current into the subsurface, as is the case in DC resistivity surveying, the CCR method capacitively injects the current into the ground. A transmitter electrifies two coaxial cables (transmitter dipole) with an AC signal with a frequency range between 1 to 25 kHz. The dipole electrodes consist of coaxial cables in which the coaxial cable shield acts as one plate of a capacitor, and the earth as the other plate. A matched receiver, automatically tuned to the transmitter frequency, measures the associated voltage on the receiver's dipole cables.

The receiver then transmits a voltage measurement, normalized to current, to the logging console. CCR systems are deployed by pulling a string of electrodes along the ground. This method allows the determination of a nearly continuous apparent resistivity profile with the horizontal resolution that is dependent on the sampling rate (approximately 1 to 2 samples per second). Figure 6-9 shows the Geometrics OhmMapper capacitively-coupled resistivity system being used to survey along the toe of a levee. The same inversion computer programs used for DC resistivity may be used for CCR.

Figure 6-9. Illustration of the Geometrics OhmMapper capacitively-coupled resistivity system being vehicle-towed along a levee toe.



As with the DC resistivity method, the resolution, or depth of investigation, is determined by the geometry of the array, not by the signal frequency or by the timing of the measurement. CCR has been shown to be sensitive to the configuration of the electrodes on the array, in addition to the array length. However, CCR is relatively insensitive to the elevation of the capacitive array above the ground surface. Highly conductive soils limit the depth of penetration of CCR systems. The primary advantages of the CCR system lie in the ability to collect data over large distances in a relatively short time without installation of permanent electrodes. However, the mobile electrode string is limited in length by practical considerations, and this in turn limits the vertical resolution.

6.9 Seismic methods

The seismic method involves creating a seismic disturbance, which propagates through the earth and recording the resultant seismic waves with geophones. Seismic energy is usually generated by an explosion or weight drop. The seismic energy travels in waves that spread out as hemispherical wavefronts (i.e., the 3-D version of the ring of ripples from a pebble dropped into a pond). The seismic energy is refracted (i.e., bent) and/or reflected at interfaces between materials with different seismic velocities (i.e., different densities). When seismic energy strikes a layer boundary having a density contrast, a portion of the energy is refracted into the underlying layer, some of it travels along the layer boundary (critically refracted), and the remainder is reflected back towards the ground surface at the angle of incidence. Geophones implanted into the ground surface and laid out in a linear array away from the seismic source respond to the arrival of the seismic waves and subsequent vibrations. The vibrations detected by the geophones are converted to electrical signals. Seismographs are used to measure the electrical signals (voltages) generated by each geophone as a function of time and synchronizes them with the seismic source. The seismograph digitally stores this information for later processing.

Two commonly recorded seismic waves used in seismic surveying are compressional (P) and shear (S) waves. The particle motion of P-waves is extension and compression along the propagating direction. Besides being able to travel through the earth, P-waves can also propagate through air and water. S-waves travel slightly slower than P-waves in solids. The particle motion of S-waves is perpendicular to the propagating direction, like the movement of a rope as a displacement travels along its length.

S-waves can only travel through a material that has shear strength, therefore, S-waves cannot propagate through liquids and gasses because these media have no shear strength.

Seismic surveys can provide P- and S-wave velocity values of subsurface materials, which can be related to certain engineering properties. The relation between S-wave velocity (V_s), the shear modulus (G) and density (ρ) is given as:

$$V_s = \left(\frac{G}{\rho} \right)^{1/2} \quad (3)$$

The relation between P-wave velocity (V_p) and the elastic constants Young's modulus (E), Poisson's ratio (ν), bulk modulus (K), shear modulus, λ (Lame's constant), and density are given as follows:

$$V_p = \left(\frac{(\lambda + 2G)}{\rho} \right)^{1/2} = \left(\frac{\left(K + \frac{4}{3}G \right)}{\rho} \right)^{1/2} \quad (4)$$

$$E = \frac{\rho V_p^2 (1 - 2\nu)(1 + \nu)}{(1 - \nu)} \quad (5)$$

The relation between the P-wave and S-wave velocities and Poisson's ratio is:

$$\nu = \frac{[v_p - v_s]^2 - 2}{2[(v_p - v_s)] - 1} \quad (6)$$

S-wave velocity data are also useful for estimating in situ Standard Penetration Test (SPT) N-values using empirical correlations between S-wave velocity and N-values.

6.10 Seismic refraction

The seismic refraction method allows general soil types and the approximate depth to layer boundaries, or to bedrock, to be determined. It is also

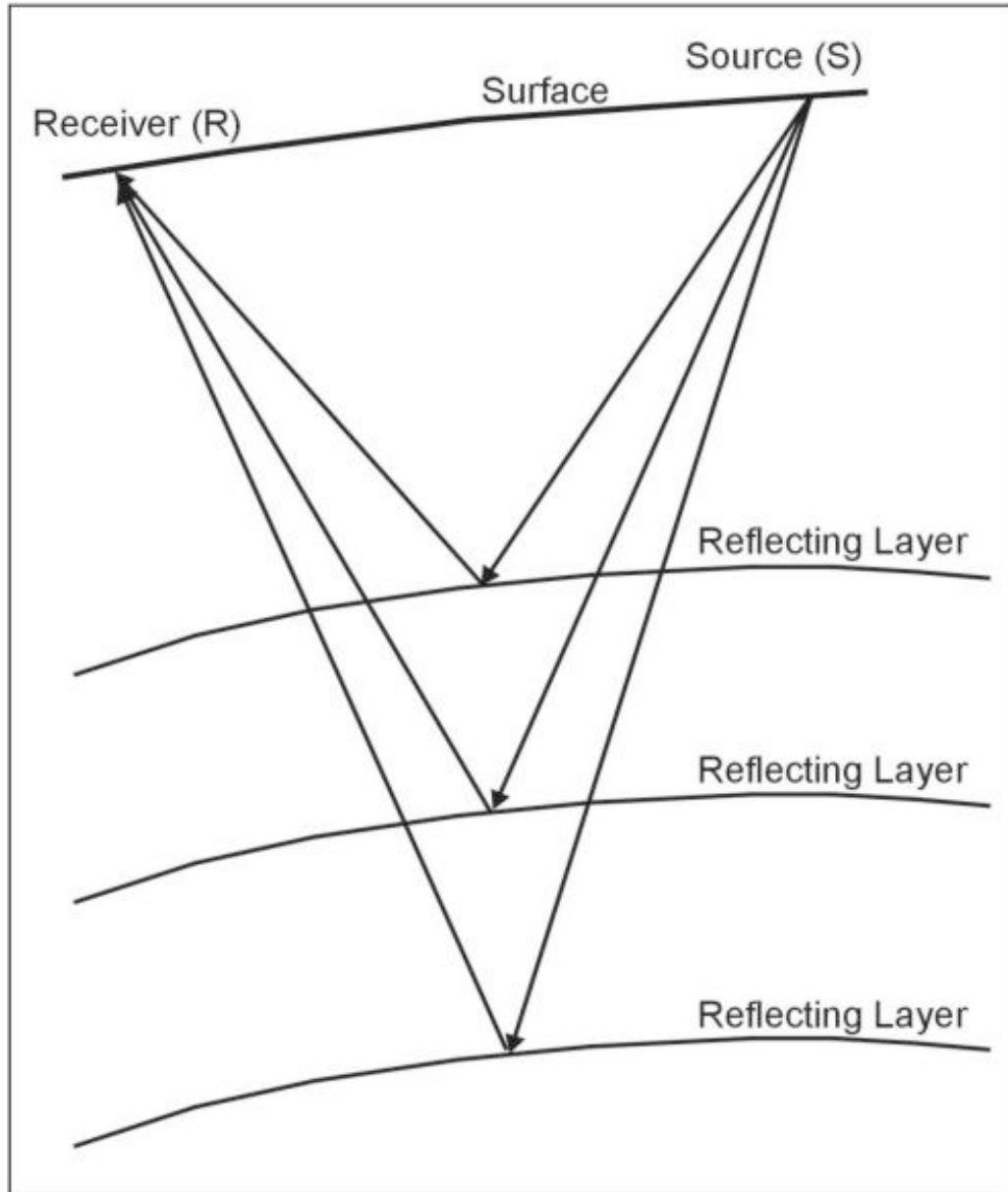
very useful in identifying the depth to the water table in unconsolidated material. The seismic refraction method measures the time seismic energy travels from the source down to a boundary with a distinct density contrast, is refracted along the top of rock (critical refraction), and returns to the surface as a head wave. The method requires that the subsurface materials be made up of layers of material that increase in seismic velocity with depth. The requirement for increasing velocity is a severe constraint for many shallow applications, where low-velocity layers are often encountered within a few meters or tens of meters below the earth's surface. Therefore, where higher velocity layers (e.g., clay) overlie lower velocity layers (e.g., sand or gravel), seismic refraction may yield incorrect results. The length of the geophone line is usually four to five times the depth of investigation. This line distance limits the depth of investigation to about 30 m when using a sledgehammer as a seismic source. In order to investigate to greater depths, longer geophone lines are required, necessitating the use of stronger seismic sources such as explosives.

The time of arrival of the first seismic energy at each geophone is plotted versus its respective distance from the source. These plots show cross sections of the depth of subsurface layers along with their respective seismic velocity.

6.11 Seismic reflection

The seismic reflection method measures the time it takes for a seismic wave, initiated at the ground surface, to propagate through the ground and reflect from subsurface structures back to the ground surface (Figure 6-10). It provides information about the geometry of underground structures and the physical properties of the materials present. Seismic energy traveling downward will reflect back to the surface wherever the velocity or density of subsurface materials increases or decreases abruptly (e.g., water table, alluvium/bedrock contact, limestone/shale contact). If these differences in density and/or velocity are not large enough, the seismic energy will pass through the boundary and not reflect back to the surface. As in the seismic refraction method, geophones laid out on the ground surface using a known geometry are used to measure the reflected seismic waves. Figure 6-10 illustrates the physical process of reflection where seismic energy is shown reflecting from several boundaries.

Figure 6-10. Illustration showing the seismic reflection concept where a seismic disturbance is initiated by a source (S) on the surface and seismic energy reflecting from different layers to receivers (R) located on the ground surface (HQUSACE 1995b).



Images of reflectors (velocity or density contrast) are used to interpret subsurface conditions and materials. Reflections returning from reflectors to seismic sensors will follow travel paths determined by the velocities of the materials through which they propagate. Reflection arrivals on seismic data recorded with multiple seismic sensors at different offsets (distance between source and seismic sensor) from the source can be collectively used to estimate the velocity (approximate average) of the material

between the reflection point and seismic sensor. Reflections can be used to characterize properties of the subsurface such as continuity, thickness, and depth of layers and changes in velocity and material type. The classic use of the seismic reflection method is to identify boundaries of layered geologic units. However, the technique can also be used to search for localized anomalies such as sand or clay lenses and faults.

The seismic energy may be a hammer striking the ground, an aluminum plate, or weighted plank, drop weights of varying sizes, rifle shot, a harmonic oscillator, waterborne mechanisms, or explosives. The type of survey dictates some source parameters. Smaller mass, higher frequency sources are preferable. Higher frequencies give shorter wavelengths and more precision in choosing arrivals and estimating depths. Yet, sufficient energy needs to be transmitted to obtain a strong return at the end of the survey line.

6.12 Multi-channel analysis of surface waves (MASW)

The MASW method is probably the most applicable of the seismic survey methods for evaluating levees and their foundations. It provides an estimate of the shear-wave velocity of layered earth materials and information needed to calculate shear modulus. The shear modulus is generally equated with material strength or rigidity, which is used for geotechnical engineering purposes. Rearranging equation 3 provides an equation for solving the shear modulus:

$$G = \rho V_s^2 \quad (7)$$

It can be seen from this equation that shear modulus, or material rigidity, increases with the square of the shear-wave velocity. From this relationship, a relative measure of material strength can be determined allowing areas of susceptible to failure to be identified along a levee.

In the MASW method, seismic surface waves (Rayleigh and Love) are generated using various types of seismic sources, such as mechanical thumpers, vibrators, or a sledgehammer striking the ground. A broadband low frequency source is ideal. The elastic constants of earth materials change with depth and material type. Rayleigh wave velocity is dependent on wavelength and consequently frequency, a phenomenon known as dispersion. In an ideal homogeneous material, Rayleigh waves show no

dispersion. However, when Rayleigh waves travel through the earth they show a dispersive behavior because the earth is made up of materials with different densities and velocities. The MASW method takes advantage of this phenomenon. The depth to which Rayleigh waves travel into the earth is dependent on wavelength; the longer the wavelength, the deeper the Rayleigh wave can penetrate. A 1-D inversion of the data providing shear wave velocity versus depth information is possible using the fact that waves with shorter wavelengths travel at different velocities and depths than those with longer wavelengths. Rayleigh waves have a speed slightly less than shear waves, by a factor of about 0.9 and are dependent on the elastic constants of the materials (Xia 1999). The 1-D shear wave velocity traces that result from each multi-channel record can be gathered to produce a 2-D cross section when data are acquired continuously with a consistent receiver spread and source offset.

An important advantage of the MASW method over body-wave seismic methods (such as refraction and reflection) is that the amplitude of surface-wave energy is normally several orders of magnitude greater than body-wave energy, which permits use of pressure contact geophone coupling to measure surface waves. Unlike body-wave methods, which generally require invasive planting of geophones for optimal recording, pressure coupling is highly suited for the use of towable land streamers for MASW surveys, thereby permitting near-continuous data acquisition and greatly increased field data acquisition efficiency compared to traditional seismic methods. MASW methods have been used successfully to determine changes in levee properties during a simulated flood event (Dunbar et al. 2006)

7 Conclusions and Recommendations

A broad range of technologies and methods were evaluated in this study for purposes of determining the state-of-practice in remote sensing, instrumentation, and monitoring. Further studies should be conducted using the following technologies:

- Ground-based and helicopter-borne FLIR technology for detection and monitoring of seepage areas during flooding to identify sand boil locations behind levees. Research should be conducted to assess technology and improve detection capabilities.
- Develop capabilities for portable UAV aircraft to monitor seepage areas and for use in acquiring flood imagery. Standard operating procedure should be developed and should be basic equipment at each District for use in monitoring problem seepage areas and for hazard assessment in the watershed. Research to develop effective techniques, tactics, and procedures (TTP) need to be developed for flood fight applications. Ideally, miniaturization of thermal capabilities would be incorporated into this capability.
- Study high-resolution LiDAR data and relationship of sand boils to elevation and landforms. Sand boil formation involves a complex relationship between the hydraulic head, the critical gradient, and the exit gradient, which is a function of the entry points for the seepage (river channel and/or nearby lakes and borrow pits), blanket thickness, aquifer properties, and the geology (landform types, orientation, and position of ridge and swales to levee system, permeability of soils, magnitude of seepage). Studies of sand boil locations during major flood should be performed to characterize basic properties of the boils, as well as obtain soil samples from the sand boil ejecta to determine the properties of the sands (i.e., grain-size distribution). Sand boil ejecta are derived from the underlying substratum sands and their provenance determined. These relationships need to be better quantified for the Mississippi River system and other river systems across the United States.
- Major investments in instrumentation and monitoring have been conducted at levee sites by groups outside USACE (IJKdijk and iLevee as examples). USACE should provide a meaningful research budget to support internal research efforts in terms of the state-of-practice,

installation by USACE personnel and personnel training. Research efforts into these activities will benefit USACE with important lessons learned, further the state-of-practice, and provide benefits in risk reduction measures at critical areas across the United States.

- InSAR remote sensing involving short-and long-term monitoring of subsidence in the Louisiana Deltaic Plain and California Central Valley Delta should be performed. These deltaic areas are experiencing significant subsidence rates because of their geology and man-made alterations to the environment and are critically important for both environmental and societal benefits. InSAR monitoring and study should be performed to assess the factors responsible and then devise effective solutions to mitigate these processes.
- Fiber-optic monitoring for seepage detection is a cost-effective solution for evaluating long levee reaches when considering the linear extent involved. Research needs to be performed to develop TTPs for this technique to improve and standardize capability. A variety of vendors offer the electronic boxes for performing this detection. Standards and procedures need to be developed for monitoring, geological application, and evaluation of results of this monitoring. Test areas should be developed in urban areas for purposes of gathering information for research and to develop early warning capabilities at these locations. Fiber-optic cable is relatively inexpensive in terms of its overall cost for a 30-km test reach. Installation as a function of the geology and seepage potential at each site needs to be quantified and better understood in terms of signatures and their characteristics related to poor performance.

References

- Aanstoos, J. V., K. Hasan, C. O'Hara, S. Prasad, L. Kabbiru, M. Mahrooghy, B. Gokaraju, M. Lee, and R. A. Nobrega. 2011. Earthen levee monitoring with synthetic aperture radar. In *Proc. IEEE Applied Imagery Pattern Recognition Workshop, Washington, DC*.
- Aanstoos, J., L. Dabbiru, B. Gokaraju, K. Hasan, M. Lee, M. Mahrooghy, R. Nobrega, C. O'Hara, S. Prasad, and A. Shanker. 2012a. *Levee assessment via remote sensing*, SERRI Project Report 80023-02. Starkville, MS: Mississippi State University.
- Aanstoos, J., L. Dabbiru, K. Hasan, M. Lee, M. Mahrooghy, R. Nobrega, C. O'Hara, S. Prasad, and A. Shanker. 2012b. *Screening of levees by synthetic aperture radar*. SERRI Project Report 90008-01. Starkville, MS: Mississippi State University.
- Abdoun, T., and V. Bennett. 2008. A new wireless MEMS-based system for real-time deformation monitoring. *Geotechnical Instrumentation News*. March.
- Abraham, J., J. C. Cannia, P. A. Bedrosian, M. R. Johnson, L. B. Ball, and S. Sibray. 2011. *Airborne electromagnetic mapping of the base of aquifer in areas of western Nebraska*. Scientific Investigations Report 2011-5219. U.S. Department of the Interior. Denver, CO: U.S. Geological Survey. <http://pubs.usgs.gov/sir/2011/5219/sir2011-5219.pdf>.
- Amos, C., R. Burgmann, G. Fisher, D. Rood, and A. Jayco, 2013. *New terrestrial LiDAR and cosmogenic radionuclide constraints on the Little Lake Fault, Eastern California shear zone*. Berkeley Seismological Laboratory Annual Reports. http://seismo.berkeley.edu/annual_report/ar09_10/node5.html.
- Asch, T. H, B. L. Burton, M. H. Powers, B. D. Rodriguez, P. Bedrosian, and L. E. Hunter. 2007. Electrical characterization of Success Dam in Porterville, California. In *Proceedings of SAGEEP 2007. Denver, CO*.
- Ball, L. B., W. H. Dress, G. V. Steele, J. C. Cannia, and M. J. Andersen. 2006. *Determination of canal leakage potential using continuous resistivity profiling techniques, Interstate and Tri-State Canals, western Nebraska and eastern Wyoming, 2004*. U.S. Geological Survey Scientific Investigations Report 2006-5032. Denver, CO. <http://pubs.usgs.gov/sir/2006/5032/pdf/sir2006-5032.pdf>.
- Bally, P. 2012. *Scientific and Technical Memorandum of the International Forum on Satellite EO and Geohazards, 21-23 May, Santorini, Greece*. Ed, P. Bally.
- Barendse, M. 2012. *Field evaluations of ShapeAccelArray in-place MEMS inclinometer strings for subsurface deformation monitoring*. Report No. SPR #C-06-02. Albany, NY: NYS Department of Transportation. <https://www.dot.ny.gov/divisions/engineering/technical-services/trans-r-and-d-repository/C-06-02%20final%20report.pdf>.
- Bassett, R. 2012. *A guide to field instrumentation in geotechnics: Principles, installation and reading*. New York, NY: Spon Press.

- Bates, R. L., and J. A. Jackson. 1980. *Glossary of geology*. Falls Church, VA: American Geological Institute.
- Bennett, P. 2008. Distributed optical fibre strain measurements in civil engineering. *Geotechnical Instrumentation News* 57:23-26. BiTech Publishers Ltd.
- Billington, D. P., D. C. Jackson, and M. V. Melosi. 2005. The history of large federal dams: Planning, design, and construction. U.S. Department of the Interior. Denver, CO: Bureau of Reclamation.
- Bond, J., and R. Nyren. 2012. Remote monitoring of deformations using Differential Global Positioning System (D-GPS). *Geotechnical Instrumentation News*, June 2012.
- Branch, A. 2007. Dallas Floodway, trip report for inspection on 3 and 5 July 2007. Memorandum for Record. Fort Worth, TX: U.S. Army Engineer District, Fort Worth.
- Brouillette, R. P. 2012. *Intelligent levee project, Greater New Orleans, status update to Southeast Louisiana Flood Protection Authority – East*. Baton Rouge, LA: Coastal Protection and Restoration Authority of Louisiana.
- Burland, J., T. Chapman, H. Skinner, and M. Brown. 2012. *ICE manual of geotechnical engineering, volume II*. Geotechnical design, construction and verification. ICE: London.
- Burton, B., and J. C. Cannia. 2011. *Capacitively coupled resistivity survey of the levee surrounding the Omaha Public Power District Nebraska City Power Plant, June 2011*. Open-File Report 2011-1211. U.S. Department of Interior. Denver, CO: U.S. Geological Survey, Denver, CO. <http://pubs.usgs.gov/of/2011/1211/report/OF11-1211.pdf>.
- Campbell, J. B. 1996. *Introduction to remote sensing*. New York: The Guilford Press.
- Campbell, J. H. 2012. Levees, invasives monitored from above. *The Corps Environment* 13(2):14-15.
- Casas, A., D. Riano, J. Greenberg, and S. Ustin. 2012. Assessing levee stability with geometric parameters derived from airborne LiDAR. *Remote Sensing of Environment* 117:281-288.
- Central Washington University. 2013. *Cascadia Hazards Institute, GPS monitoring of natural hazards, Tolt Reservoir*. Ellensburg, WA: Central Washington University. <http://www.geodesy.cwu.edu/>.
- Consentino, P. J., P. B. Lloyd, and F. Campero. 2002. *Developing geotechnical applications for the fiber optic pore water pressure sensor phase I*. Florida Institute of Technology, Civil Engineering Department. Melbourne, FL: Florida Institute of Technology.
- Contreras, I. A., A. T. Grosser, and R. H. Strate. 2012. Update of the fully-grouted method for piezometer installation. *Geotechnical Instrumentation News*, 20-25.

- Contreras, I. A., A. T. Grosser, and R. H. Ver Strate. 2007. The use of the fully-grouted method for piezometer installation. *Field Measurements in Geomechanics 2007: Seventh International Symposium on Field Measurements in Geomechanics*. ASCE.
- Cook, D. 2006. Robotic total stations and remote data capture: Challenges in construction. *Geotechnical Instrumentation News*, December 2006:42-45.
- _____. 2010. Fundamentals of instrumentation geotechnical database management—things to consider. *Geotechnical News*. *Geotechnical Instrumentation News Section*, 25-28.
- Cunny, R. W. 1987. *Inspection and control of levee underseepage during flood fights*. Technical Report REMR-GT-5. Vicksburg, MS: U.S. Army Engineer Waterways Experiment Station.
- De Vries, G., A. R. Koelewijn, and V. Hopman. 2010. IJkdijk full scale underseepage erosion (piping) test: Evaluation of innovative sensor technology. *Fifth International Conference on Scour and Erosion (ICSE-5), San Francisco, CA: 649-657*.
- Dixon, T. H., R. Amelung, A. Ferretti, F. Novali, F. Rocca, R. Dokka, G. Sella, S. Kim, S. Wdowinski, and D. Whittman. 2006. Subsidence and flooding in New Orleans. *Nature* 441:587-588.
- Doolittle, J. A., F. E. Minzenmayer, S. W. Waltman, and E. C. Benham. 2003. Ground penetrating radar soil suitability maps. Special Issue: Ground penetrating radar. *Journal of Environmental and Engineering Geophysics* 8(2):49-56.
- Doolittle, J. A., F. E. Minzenmayer, S. W. Waltman, E. C. Benham, J. W. Tuttle, and S. D. Peaslee. 2007. Ground-penetrating radar soil suitability map of the conterminous United States. ScienceDirect, *Geoderma* 141:416-421.
- Dunbar, J. B., and V. H. Torrey. 1991. *Geologic, geomorphological, and geotechnical aspects of the Marchand Levee failure, Marchand, Louisiana*. Miscellaneous Paper GL-91-17. Vicksburg, MS: U.S. Army Engineer Waterways Experiment Station.
- Dunbar, J. B., R. F. Ballard, W. L. Murphy, T. E. McGill, J. L. Llopis, L. D. Peyman-Dove, and M. J. Bishop. 2003. *Condition assessment of U.S. International Boundary and Water Commission, Lower Rio Grande Valley levees, South Texas, Volumes I and II*. ERDC TR-03-4. Vicksburg, MS: U.S. Army Engineer Waterways Experiment Station.
- Dunbar, J. B., W. L. Murphy, R. F. Ballard, T. E. McGill, L. D. Peyman-Dove, and M. J. Bishop. 2004. *Condition assessment of U.S. International Boundary and Water Commission, Texas and New Mexico levees, Volumes I and II*. ERDC TR-03-4. Report 2. Vicksburg, MS: U.S. Army Engineer Waterways Experiment Station.
- Dunbar, J. B., and J. L. Llopis. 2005. *Condition assessment of U.S. International Boundary and Water Commission Tijuana River Levees, San Diego, California*. ERDC/GSL TR-03-4 Report 4. Vicksburg, MS: U.S. Army Engineer Waterways Experiment Station.

- Dunbar, J. B., J. L. Llopis, G. Sills, and E. W. Smith. 2006. *Flood simulation study of retamal levee, Lower Rio Grande Valley, Texas, using seismic and electrical geophysical methods*. ERDC/GSL-TR-03-04, Report 5. Vicksburg, MS: U.S. Army Engineer Research and Development Center.
- Dunbar, P. K., and C. S. Weaver. 2008. U.S. States and Territories National Tsunami Hazard Assessment: Historical Record and Sources of Waves. National Tsunami Hazard Mitigation Program, National Oceanic and Atmospheric Administration and U.S. Geological Survey. <http://www.ngdc.noaa.gov/hazard/tsupub.shtml>
- Dunnicliff, J. 1993. *Geotechnical instrumentation for monitoring field performance*. New York: John Wiley & Sons, Inc.
- Dunnicliff, J. 2012. Chapter 95: Types of geotechnical instrumentation and their usage. In: *ICE manual of geotechnical engineering*, ed. J. Burland, T. Chapman, I. Skinner, and M. Brown, 1379-1403. British Geotechnical Association, ICE Publishing.
- Eakins, B. W., and L. A. Taylor. 2010. Seamlessly integrating bathymetric and topographic data to support tsunami modeling and forecasting efforts, Chapter 2. In *Ocean Globe*, ed. J. Breman. 37-56. ESRI Press, Redlands.
- Elachi, C. 1983. Seeing under the Sahara: Spaceborne imaging radar. *Engineering and Science* 4-8.
- Elliott, D. O. 1932. *The improvement of the Lower Mississippi River for flood control and navigation*. Three volumes. Vicksburg, MS: U.S. Army Engineer Waterways Experiment Station.
- Federal Emergency Regulatory Commission (FERC). 2010. Chapter IX: Instrumentation and monitoring. In *Engineering guidelines for the evaluation of hydropower projects*. Washington, DC: Federal Emergency Regulatory Commission.
- Federal Highway Administration. 1977. *An evaluation of expedient methodology for identification of potentially expansive soils*. Report No. FHWA-RD-77-94. Washington, DC: Federal Highway Administration.
- Ferguson, H. B. 1939. *History of improvement of the Lower Mississippi River for flood control and navigation*. War Department, U.S. Army Corps of Engineers. Vicksburg, MS: Mississippi River Commission.
- Fisk, H. N. 1941. *Application of geological studies to underseepage problems in the Lower Mississippi Valley*. Letter report to President, Mississippi River Commission, 12 December 1941. Vicksburg, MS: Mississippi River Commission.
- Fisk, H. N. 1944. *Geological investigation of the alluvial valley of the Lower Mississippi River*. Vicksburg, MS: Mississippi River Commission.
- Flood Control 2015. 2013a. Flood Control 2015: Solutions for smart flood control, real-time monitoring, accurate forecasting, effective decision-making, general brochure, ARCADIS, Deltares, Fugro, HKV, IBM, ITC, Ijkdijk Foundation, Royal Haskoning and TNO. <http://www.floodcontrol2015.com/downloads>.

- Flood Control 2015. 2013b. Flood Control 2015 – Five years of innovation in flood risk, report, ARCADIS, Deltares, Fugro, HKV, IBM, ITC, Ijkdijk Foundation, Royal Haskoning and TNO. <http://www.floodcontrol2015.com/downloads>.
- Flood Risk Management Research Consortium (FRMRC). 2012. *Initial review report for steering group*. FRMRC2 WP4.2. HR Wallingford, UK. <http://www.ambiental.co.uk/flood-risk-assessment/>
- Flowline. 2011. EchoSonic II Manual, Los Alamitos, CA. <http://www.automationdirect.com/static/manuals/echosonic/echosonic-lu23-lu27-lu28-lu29-cable-m.pdf>.
- Fortune. 2012. The future is now, look up in the sky. *Fortune Magazine*. 47
- Franken, P. A., and S. J. Flos. 2005. Using a helicopter based laser altimetry system (FLI-MAP) to carry out effective dike maintenance and construction policy. In *Floods from Defence to Management*, ed. Van Alphen, Van Beek, and Teal, 145-151. London: Taylor and Francis Group. ISBN 0415 38050 2.
- Freeman, L. A., M. C. Carpenter, D. O. Rosenberry, J. P. Rousseau, R. Unger, and J. S. McLean. 2004. Chapter A: Use of submersible pressure transducers in water-resources investigations. In *USGS, Book 8, Instrumentation, Section A, Instruments for measurement of water level*. Denver, CO: USGS. <http://pubs.usgs.gov/twri/twri8a3/pdf/twri8-a3.pdf>.
- Fugro Aerial and Mobile Mapping, Inc. (Fugro). 2005. Projects: New Orleans levees, Rio Grande levees. <http://www.flimap.com/site316.php>.
- Furlong, J. N., G. Ajemian, and T. McPherson. 2003. *History of the Dallas Floodway*. Fall 2003 ASCE Meeting.
- Gaffran, P., and M. Jefferies. 2005. *Investigation of geophysical methods for assessing seepage and internal erosion in embankment dams: A study of through-dam seismic testing at WAC Bennett Dam*. Montreal, Quebec: Canadian Electrical Association Technologies.
- Garn, H. S., D. M. Robertson, W. J. Rose, G. L. Goddard, and J. A. Horwath, 2006. *Water quality, hydrology, and response to changes in phosphorus loading of Nagawicka Lake, a calcareous lake in Waukesha County, Wisconsin*. Scientific Investigations Report 2006-5273. U.S. Department of the Interior. Reston, VA: U.S. Geological Survey. http://pubs.usgs.gov/sir/2006/5273/pdf/SIR_2006-5273.pdf.
- Geocomp Corporation. 2013. *Intelligent Levee (iLevee)*. Project Brief. http://www.geocomp.com/files/showcase/pd11037_iLevee.pdf.
- Geokon. 2012. Model 4435 Vibrating wire soil extensometer. Lebanon, NH: Geokon. http://www.geokon.com/content/datasheets/4435_Soil_Extensometer.pdf.
- Geonics Ltd. 2005. EM61-Mk2 and EM61-Mk2HP 4 channel high sensitivity metal detectors, Operating Manual. Mississauga, Ontario, Canada: Geonics Limited.
- Geotechnical Observations (Geo). 2013. Company. <http://www.geo-observations.com/Company/index.html>.
- Global Water. 2013. WL400 Water Level Sensor, Data Sheet. Gold River, CA.

- Guillou, D. F. 2003. Packaging MEMS: New manufacturing methodology substantially reduces smart MEMS costs. *Sensors*, December 2003.
- Gutshall, J. 2012. Personal communication, Red Hen airborne surveys for low water inspections of riverbanks on the Mississippi River, Lower Mississippi Valley Division. Vicksburg, MS: U.S. Army Corps of Engineers, Mississippi Valley Division.
- Headquarters, U.S. Army Corps of Engineers (USACE). 1981. *Engineering and design, strong motion instruments for recording earthquake motions on dams*. Engineer Manual (EM) 1110-2-103. Washington, DC: Headquarters, U.S. Army Corps of Engineers.
- Headquarters, U.S. Army Corps of Engineers (USACE). 1987. *Instrumentation for concrete structures*. Engineer Manual (EM) 1110-2-4300. Washington, DC: Headquarters, U.S. Army Corps of Engineers.
- Headquarters, U.S. Army Corps of Engineers (USACE). 1995a. *Earthquake design and evaluation for civil works projects*. Engineer Manual (EM) 1110-2-1806. Washington, DC: Headquarters, U.S. Army Corps of Engineers.
- Headquarters, U.S. Army Corps of Engineers (USACE). 1995b. *Geophysical exploration for engineering and environmental investigations*. Engineer Manual (EM) 1110-1-1802. Washington, DC: Headquarters, U.S. Army Corps of Engineers.
- Headquarters, U.S. Army Corps of Engineers (USACE). 1995c. *Gravity dam design*. Engineer Manual (EM) 1110-2-2200. Washington, DC: Headquarters, U.S. Army Corps of Engineers.
- Headquarters, U.S. Army Corps of Engineers (USACE). 1995d. *Instrumentation of embankment dams and levees*. Engineer Manual (EM) 1110-2-1908. Washington, DC: Headquarters, U.S. Army Corps of Engineers.
- Headquarters, U.S. Army Corps of Engineers (USACE). 2000. *Design and construction of levees*. Engineer Manual (EM) 1110-2-1913. Washington, DC: Headquarters, U.S. Army Corps of Engineers.
- Headquarters, U.S. Army Corps of Engineers (USACE). 2001. *Emergency employment of Army and other resources, Civil Emergency Management Program – Procedures*. RCS CECW-o-65. EP 500-1-1. Washington, DC: Headquarters, U.S. Army Corps of Engineers.
- Headquarters, U.S. Army Corps of Engineers (USACE). 2004. *Earth and rock-fill dams: General design and construction considerations for earth and rock-fill dams*. Engineer Manual (EM) 1110-2-2300. Washington, DC: Headquarters, U.S. Army Corps of Engineers.
- Headquarters, U.S. Army Corps of Engineers (USACE). 2009. Guidelines for landscape planting and vegetation management at levees, floodwalls, embankment dams, and appurtenant structures. Engineer Technical Letter (ETL) 1110-2-571. Washington, DC: Headquarters, U.S. Army Corps of Engineers.

- Headquarters, U.S. Army Corps of Engineers (USACE). 2010. USACE process for the National Flood Insurance Program (NFIP) levee system evaluation. EC 1110-2-6067. Washington, DC: Headquarters, U.S. Army Corps of Engineers.
- Headquarters, U.S. Army Corps of Engineers (USACE). 2011. *Safety of dams – Policy and procedures*. Engineer Manual (EM) 1110-2-1156. Washington, DC: Headquarters, U.S. Army Corps of Engineers.
- The Heinz Center. 2000. *Evaluation of erosion hazards*. Report prepared for the Federal Emergency Management Agency Contract EMW-97-CO-0375.
- Hodges, G. 2003. Helicopter electromagnetic manual. Version 1.0. Mississauga, Ontario, Canada: Fugro Airborne Surveys, Inc., 83 p.
- Hope, C. 2008. Manual total station monitoring. *Geotechnical Instrumentation News*, September, 28-30.
- Hossain, A. K., G. Easson, and K. Hasan. 2006. Detection of levee slides using Commercially available remotely sensed data. *Environmental and Engineering Geosciences* 12(3):235-246.
- Huang, H. 2005. Depth of investigation from small broadband electromagnetic sensors. *Geophysics* 70:135-142.
- Hunter, L., T. Asch, M. Powers, B. Burton, and S. Haines. 2007. Geophysical investigation of the Success Dam foundation: An overview. In *Proceedings of SAGEEP 2007*. Denver, CO.
- Inaudi, D., and B. Glisic. 2006. Distributed fiber optic strain and temperature sensing for structural health monitoring. In *IABMAS'06 The Third Int'l Conference on Bridge Maintenance, Safety and Management, Porto, Portugal*.
- Inaudi, D., and B. Glisic. 2007a. Overview of fiber optic sensing technologies for geotechnical instrumentation and monitoring. *Geotechnical Instrumentation News* 52:4-8. BiTech Publishers Ltd. (http://www.bitech.ca/instrumentation_news.php).
- Inaudi, D., and B. Glisic. 2007b. Distributed fiber optic sensors: Novel tools for the monitoring of large structures. *Geotechnical Instrumentation News* 52:8-12. BiTech Publishers Ltd http://www.bitech.ca/instrumentation_news.php.
- Inaudi, D., S. Vurpillot, G. Martinola, G. Steinman, and J. Mathier. 1999. *SOFO: Structural monitoring with fiber optic sensors*. FIB, Monitoring and Safety Evaluation of Existing Concrete Structures, Vienna, Austria. <http://www.roctest-group.com/sites/default/files/bibliography/pdf/c33.pdf>.
- Inaudi, D., S. Vurpillot, and E. Udd. 1998. *Long-gage structural monitoring for civil structures*. SPIE 3489:93-100.
- Institution of Civil Engineers (ICE). 2012. *ICE manual of geotechnical engineering, Volume II geotechnical design, construction, and verification*, ed. J. Burland, T. Chapman, H. Skinner, and M. Brown. The British Geotechnical Association. London: ICE Publishing.

- Itmsoil. 2012. J2 Vibrating wire crackmeter, datasheet J2, itmsoil, East Sussex, UK. <http://usa.itmsoil.com/pages/vibrating+wire+crackmeter>.
- Jensen, J. R. 2007. *Remote sensing of the environment; An earth resource perspective*. 2nd ed. Upper Saddle River, NJ: Pearson-Prentice Hall.
- Johansson, S., J. Friberg, J. Claesson, T. Dahlin, G. Hellstrom, and B. Zhou. 2005. *Investigation of geophysical methods for assessing seepage and internal erosion in embankment dams: A parameter study for internal erosion monitoring*. Report 1 of Series, CEATI Report No. T992700-0205A, Dam Safety Interest Group. Montreal, Quebec: CEA Technologies Inc.
- Johansson S., and P. Sjö Dahl. 2004. Downstream seepage detection using temperature measurements and visual inspection – Monitoring experience from Rosvatn Field Test Dam and large embankment dams in Sweden. *Sensornet*.
- Johansson S., and P. Sjö Dahl. 2009. *A guide for seepage monitoring of embankment dams using temperature measurements*. Canadian Electricity Association – Dam Safety Interest Group CEATI Report No T062700-0214.
- Johansson, S., and D. Watley. 2007. Experiences from distributed strain measurements in five embankment dams 2004 – 2007. Elforsk rapport 07:52, Stockholm, Sweden. http://www.hydroresearch.se/en/downloads/07_52_rapport_DTSS4.pdf.
- Joyce, K. E., S. E. Belliss, S. V. Samsonov, S. J. McNeill, and P. J. Glassey. 2009. A review of the status of satellite remote sensing and image processing techniques for mapping natural hazards and disasters. *Progress in Physical Geography* 33(2):183-207.
- Keller, G. V. and F. C. Frischknecht. 1966. *Electrical methods in geophysical prospecting*. New York: Pergamon Press.
- Koelewign, A. 2009. Deltares GeoAcademy course on Geotechnical Instrumentation for Field Monitoring – 21-23 April 2009, Session S. New Measurement Technology for Dike Monitoring. GIFM.
- Koelewign, A. 2012. Testing levees to failure: An overview of the Ijkdijk large-scale levee tests and associated research. Presentation to Colorado School of Mines Smart Geo Program, 4 December 2012, Deltares, Netherlands.
- Koester, J. P., D. K. Butler, S. S. Cooper, and J. L. Llopis. 1984. *Geophysical investigations in support of Clearwater Dam comprehensive seepage analysis*. Misc. paper GL-84-3. Vicksburg, MS: U.S. Army Engineer Waterways Experiment Station.
- Krinitzsky, E. L. 1965. *Geological influences on bank erosion along meanders of the Lower Mississippi River*. Potamology Investigations Report 12-15. Vicksburg, MS: U.S. Army Engineer Waterways Experiment Station.
- Lato, Matthew J. 2012. Remote monitoring of deformation using Terrestrial Laser Scanning (TLS of Terrestrial LiDAR). *Geotechnical Instrumentation News*, March, 27.

- Lee, B. H., Y. H. Kim, K. S. Park, J. B. Eom, M. J. Kim, B. S. Rho, and H. Y. Choi. 2012. Interferometric fiber optic sensors. *Sensors* 12:2467-2486. <http://www.mdpi.com/1424-8220/12/3/2467>.
- Lemke, J., M. Driller, and D. Wilson. 2011. Web-based real-time monitoring at Perris Dam using in-place inclinometers and piezometers with an automatic notification system. *31st Annual USSD Conference, San Diego, CA*: 1527-1540.
- Llopis, J., and K. Sjostrom. 1988. *Geophysical investigation in support of Beaver Dam comprehensive seepage investigation*. Technical Report GL-88-6. Vicksburg, MS: U.S. Army Engineer Waterways Experiment Station.
- Llopis, J. L., and J. E. Simms. 2007. *Geophysical surveys for assessing levee foundation conditions, Feather River levees*. ERDC/GSL TR-07-25. Vicksburg, MS: U.S. Army Engineer Research and Development Center.
- Llopis, J. L., E. W. Smith, and R. E. North. 2007. *Geophysical surveys for assessing levee foundation conditions, Sacramento River levees*. ERDC/GSL TR-07-21. Vicksburg, MS: U.S. Army Engineer Research and Development Center.
- Lum, K. Y., and M. R. Sheffer. 2010. Dam safety: Review of geophysical methods to detect seepage and internal erosion in embankment dams. *Hydroworld* 29(2).
- Mahoney, D. J. 1990. FERC's dam safety program: A new focus on monitoring. *Hydro Review* 9(3):38-45.
- Mansur, C. I., R. I. Kaufman, and W. M. Nichols. 1956a. *Investigation of underseepage Mississippi River levees, Alton to Gale, IL*. Technical Memorandum No. 3-430. Vicksburg, MS: U.S. Army Engineer Waterways Experiment Station.
- Mansur, C. I., R. I. Kaufman, and J. R. Schultz. 1956b. *Investigation of underseepage and its control, Lower Mississippi River levees*. Technical Memorandum No. 3-424. Vicksburg, MS: U.S. Army Engineer Waterways Experiment Station.
- Marr, A. W. 2008. Monitoring deformations with automated total stations. *Geotechnical Instrumentation News*, September, 30-33.
- Massanti, P. 2012. Remote monitoring of deformation using Terrestrial SAR Interferometry (TInSAR, GBInSAR). *Geotechnical Instrumentation News*, March.
- Massanti, P. 2013. TinSAR Monitoring – Monitoring by terrestrial SAR interferometry, natural hazards control and assessment, Rome Italy. http://download.esa.int/docs/business_incubation/NHAZCA-brochure.pdf.
- McKenna, J. R., J. B. Dunbar, L. D. Wakeley, and S. Smullen. 2006. Near surface geophysical methods to assess levee integrity and potential failure. In *Proceedings, Society for Application of Geophysics to Environmental and Engineering Problems*. 19:320-326. Denver, CO.
- McNeill, J. D. 1980. *Electromagnetic terrain conductivity measurement at low induction numbers*. Technical Note TN-6. Mississauga, Ontario: Geonics Limited.
- Miall, A. D. 1985. Architectural-element analysis: A new method of facies analysis applied to fluvial deposits. *Earth Science Review* 22:261-308.

- Miall, A. D. 1996. *The geology of fluvial deposits*. Berlin, Germany: Springer-Verlag.
- Mikkelsen, P., and G. Green. 2003. Piezometers in fully grouted boreholes. In *Field Measurements in Geomechanics 2003: Symposium on Field Measurements in Geomechanics*. Oslo, Norway: ASCE.
- Mikkelsen, P. E. 2003. Advances in inclinometer data analysis. In *Symposium on Field Measurements in Geomechanics, FMGM 2003*. Oslo, Norway.
- Miller, R. D., and J. Ivanov. 2005. *Seismic test on IBWC levees, Weslaco, Texas*. Open-file Report 2005-56. Lawrence, KS: Kansas Geological Survey.
- Milsom, J. 2003. Field geophysics. In *The geological field guide series*. Third Edition. New York: Wiley.
- Mitchell, T. 2012. Improved characterization of dams and reservoirs, levees, and other water-related infrastructure through detailed multi-sensor surveying. In U.S. Society of Dams, *Innovative Dam and Levee Design and Construction for Sustainable Water Management, 32nd Annual USSD Conference*, 459-470. New Orleans, LA.
- Moore, N. R. 1972. *Improvement of the lower Mississippi River and tributaries*. Vicksburg, MS: Mississippi River Commission.
- National Geospatial Intelligence Agency (NGIA). 2011. *Commercial imagery guide, resources for acquiring commercial electro-optical (EO), synthetic aperture radar (SAR) and airborne products and services*. Washington, DC: National Geospatial Intelligence Agency.
- National Incident Management Systems and Advanced Technologies (NIMSAT). 2011. *Intelligent flood protection monitoring warning and response systems (iLevees)*. Lafayette, LA: University of Louisiana, Lafayette.
<http://www.nimsat.org/research-development/current-projects/intelligent-flood-protection-monitoring-warning-response>
- Nazarian, S., and J. Diehl. 2000. *Use of geophysical methods in construction*. Geotechnical Special Publication No. 108. Reston, VA: Geo-Institute of the American Society of Civil Engineers.
- Nimrod, P. 2011. 2011 flood report: A success story. Greenville, MS: Mississippi Levee Board.
- Nyren, R., R. Drefus, and S. Johnson. 2012. Remote monitoring using Robotic Total Stations (RTS). *Geotechnical Instrumentation News*, 29. March.
- Olive, W. W., A. F. Chleborad, C. W. Frahme, J. Schlocker, R. R. Schneider, and R. L. Schuster. 1989. *Swelling clays of the conterminous United States*. Scale 1:7,500,000. Miscellaneous Investigations Series Map I-1940. Reston, VA: U.S. Geological Survey.
- Omnisens. 2009. DITEST STA-RTM, user manual, fibre optic distributed temperature and strain analyzer. <http://www.roctest-group.com/products>. 85 p.

- Ozkan, S. 2003. Analytical study of flood induced seepage under river levees. PhD diss., Louisiana State University, Baton Rouge, LA.
- Patrick, D. M., H. K. Woods, and F. L. Smith. 1977. *Expansive soils map of Arkansas, Louisiana, New Mexico, Oklahoma, and Texas*. Engineering Geology and Rock Mechanics Division. Vicksburg, MS: U.S. Army Engineer Waterways Experiment Station.
- Raber, B.R., and J. Cannistra. 2005. *LIDAR Guidebook: Concepts, project design, and practical applications*. The Urban and Regional Information Systems Association.
- Rawson, D. 2013. Personal communication. Flow slide monitoring on the Mississippi River in New Orleans District. New Orleans, LA: U.S. Army Engineer District, New Orleans.
- Red Hen Systems, Inc. 2013. Hardware and software solutions for geo-tagging multimedia. <http://www.redhensystems.com/>.
- Reif, M., L. Dunkin, J. Wozencraft, and C. Macon. 2011. Sensor fusion, New airborne imaging techniques benefit complex coastal mapping and charting tasks. www.ejournal.com, 32-35.
- Reisner, M. 1986. Cadillac Desert. In *The American West and its disappearing water*. New York: Penguin Books.
- Reynolds, J. M. 2011. *An introduction to applied and environmental geophysics*. 2nd ed. New York: Wiley-Blackwell.
- Reynolds, J. M. 2012. Geophysical exploration and remote sensing. In *ICE manual of geotechnical engineering*, ed. J. Burland, T. Chapman, I. Skinner, and M. Brown, 601-618. British Geotechnical Association. ICE Publishing.
- Rickly Hydrological Company. 2013a. US Type A-71 water level recorder. Columbus OH: Rickly Hydrological Company. <http://www.rickly.com/sm/Float-Type/WaterLevelRecorders.htm#US>.
- Rickly Hydrological Company. 2013b. USGS PS-2 pressure sensor system. Columbus, OH: Rickly Hydrological Company. <http://www.rickly.com/sm/Bubbler-Type/PS-2.htm>.
- Ridley, A. M. 2013. Recent experiences of monitoring clay slopes. In *Proceedings of the 15th European Conference on Soil Mechanics and Geotechnical Engineering. Geotechnics of of Hard Soils-Weak Rocks (Part 4)*. Ed: A. Anagnostopoulos et al. IOS Press.
- Royet, P., S. Palma-Lopes, C. Fauchard, P. Meriaux, and L. Auriiau. 2012. *Rapid and cost-effective dike condition assessment methods: Geophysics and remote sensing*. Grant Agreement No. 243401. Report No. WPe-01-12-09, WP 3: Reliability of Urban flood Defences, FloodProbe.
- RST Instruments Ltd. 2013. Push-in standpipe piezometer, product data sheet, Maple Ridge, BC. <http://www.rstinstruments.com/PDFs/Push-in%20Standpipe%20Piezometer%20WLB0007C.pdf>.

- Sabins, F. L. 1997. *Remote sensing principles and interpretation*. Third Edition. New York: W. H. Freeman and Company.
- Saucier, R. T. 1994. *Geomorphology and quaternary geologic history of the Lower Mississippi Valley*. Volumes I and II. Vicksburg, MS: Mississippi River Commission.
- Scientific Software Group. 2013. Water level and interface level meters. Salt Lake City, UT. http://www.scisoftware.com/environmental_software/contact.php.
- Sellars, J. B., and R. Taylor. 2008. MEMS basics. *Geotechnical Instrumentation News*. 32-33. March.
- Sensornet. 2012. *Seepage monitoring in embankment dams using distributed temperature sensing: The natural way*. <http://www.sensornet.co.uk/images/PDF/download95dd.pdf>.
- Sharma, P. V. 1986. *Geophysical methods in geology*. New York: Elsevier.
- Sills, G. L., and A. E. Templeton. 1983. Long-term strength reduction and slough slides in Mississippi River levees. Vicksburg, MS: U.S. Army Engineer District, Vicksburg.
- Sills, G. L., and N. D. Vroman. 2005. A Review of Corps of Engineers Levee Seepage Practices in the United States. In *Workshop on Internal Erosion and Piping of Dams and Foundations, 25-27 April 2005, Aussois, France*.
- Simm, J., D. Jordan, A. Topple, I. Mokhov, A. Pyayt, T. Abdoun, V. Bennett, J. Broekhuijsen, and R. Meijer. 2013. Interpreting sensor measurements in dikes—experiences from urban flood pilot sites, comprehensive flood risk management. ed. Kilijn and Schweckendiek, Taylor and Francis Group, 327-336. http://www.alertsolutions.nl/publicationdocs/Paper_Jonathan%20Simm_Interpreting%20sensor%20measurements%20in%20dikes_nov2012.pdf
- SISGEO. 2013. Piezometers. Serpero, Italy. <http://www.sisgeo.com/>
- Sjostrom, K. J., D. K. Butler, and R. F. Ballard. 1998. *Mapping emplaced articulated concrete mattress using geoelectrical and electromagnetic techniques*. Technical Report GL-98-17. Vicksburg, MS: U.S. Army Engineer Waterways Experiment Station.
- Spencer-Associates Inc. 1980. *Mississippi River levees, Study of slough slides*. Vicksburg, MS: U.S. Army Engineer District, Vicksburg.
- Sobczyk, D. 2013. Fabry-Perot piezometers installed in spillway at Gavins Point Dam. Personal communication. Omaha, NE: U.S. Army Engineer District, Omaha.
- Sylvester, C. 2012. *Next-generation coastal mapping to further the national ocean enterprise*. Mobile, AL: U.S. Army Corps of Engineers, Mobile District.
- Tamagnan, D., and M. Beth. 2012. Remote monitoring of surface deformations with Robotic Total Stations using reflectorless measurements. *Geotechnical News*, March 2012. http://www.bitech.ca/instrumentation_news.php.
- Taylor, L. 2012. UAVs in flood fight and levee inspections. Personal communication. Jacksonville, FL: U.S. Army Engineer District, Jacksonville.

- Telford, W. M., L. P. Geldart, and R. E. Sheriff. 1990. *Applied geophysics*. Cambridge University Press. p. 149. ISBN 978-0-521-33938-4. Retrieved 8 June 2011.
- Torrey, V. H. 1988. *Retrogressive failures in sand deposits of the Mississippi River, Report 2, Empirical evidence in support of the hypothesized failure mechanism and development of the levee safety flow slide monitoring system*. Technical Report GL-88-9. Vicksburg, MS: U.S. Army Engineer Waterways Experiment Station.
- Tralli, D. M., R. G. Blom, V. Zlotnicki, A. Donnellan, and D. L. Evans. 2005. Satellite remote sensing of earthquake, volcano, flood, landslide and coastal inundation hazards. *Photogrammetry and Remote Sensing* 185-198.
- URS. 2007. *Guidance document for geotechnical analyses, urban levee geotechnical evaluations program*. Department of Water Resources. Contract 4600007418. Sacramento, CA: URS.
- URS. 2009. *Helicopter-Borne Electromagnetic (HEM) survey report*. Urban Levee Geotechnical Evaluations Program. Contract 4600007418, Task Order 22. Sacramento, CA: URS.
- U.S. Army Corps of Engineers (USACE). 1947. *Code for utilization of soils data for levees*. War Department, U.S. Army Corps of Engineers. Vicksburg, MS: Mississippi River Commission.
- U.S. Army Corps of Engineers (USACE). 1968. *Review of levee design, Dallas Floodway*. Department of the Army. Fort Worth, TX: U.S. Army Engineer District, Fort Worth.
- U.S. Army Corps of Engineers (USACE). 2005. *Strong-motion instrumentation program*. ERDC Fact Sheet. Vicksburg, MS: U.S. Army Engineer Research and Development Center.
- U.S. Army Corps of Engineers (USACE). 2006a. *Levee owners' manual for non-Federal flood-control works*. The Rehabilitation and Inspection Program, Public Law 84-99. Washington, DC
- U.S. Army Corps of Engineers (USACE). 2006b. *Maintenance standards, procedures, and guidelines on modifications to projects*. District Regulation No. 1130-2-530. U.S. Army Corps of Engineers. Vicksburg, MS: Mississippi River Commission.
- U.S. Army Corps of Engineers (USACE). 2007. *User's manual, erosion toolbox: Levee risk assessment methodology*. Project 26815944. Oakland, CA: URS Corporation.
- U.S. Army Corps of Engineers (USACE). 2011a. *Levee screening tool, methodology and application*. Washington, DC: Risk Management Center, Levee Safety Program.
- U.S. Army Corps of Engineers (USACE). 2011b. *2011 MR&T flood report*. Vicksburg, MS: Mississippi River Commission.
- U.S. Army Corps of Engineers (USACE). 2011c. *Dam safety in the Corps of Engineers*. Grenada, MS: USACE Proponent Sponsored Engineer Corps Training (PROSPECT).

- U.S. Army Corps of Engineers (USACE). 2011d. *Mount Morris Dam, seismic instrumentation*. White Paper. Vicksburg, MS: U.S. Army Engineer Research and Development Center.
- U.S. Army Corps of Engineers (USACE). 2012a. FY2011 Annual Report. U.S. Army Corps of Engineers Dam and Levee Instrumentation Committee, 12 January 2012. Pittsburgh, PA: U.S. Army Engineer District, Pittsburgh.
- U.S. Army Corps of Engineers (USACE). 2012b. *URS WINIDP/WEBIDP Workshop*. Philadelphia, PA.
- U.S. Army Corps of Engineers (USACE). 2012c. Unmanned aerial vehicle. <http://www.saj.usace.army.mil/Missions/UnmannedAerialVehicle.aspx> Jacksonville, FL: U.S. Army Engineer District, Jacksonville.
- U.S. Bureau of Reclamation. 1992. Geophysical investigations at Tabor Dam. Report D-3611. Denver, CO: U.S. Bureau of Reclamation.
- U.S. Department of Transportation. 2013. Application of geophysical methods to highway related problems. Federal Lands Highway program. Lakewood, CO.
- U.S. Geological Survey. 2011. *A promising tool for subsurface permafrost mapping: An application of airborne geophysics from the Yukon River Basin, Alaska*. Fact Sheet 2011-3133. U.S. Geological Survey. Denver, CO: U.S. Department of the Interior.
- U.S. Geological Survey. 2013. USGS definition of streamgage. USGS National Streamflow Information Program. U.S. Department of the Interior. Reston, VA: U.S. Geological Survey. <http://water.usgs.gov/nsip/definition9.html>.
- Van Beek, V. M., H. T. J. de Bruijn, J. G. Knoeff, A. Bezuijen, and U. Förster. 2010. Levee failure due to piping: A full-scale experiment. *Fifth International Conference on Scour and Erosion (ICSE-5), San Francisco, CA, 283-292*.
- Van Beek, V. M., H. Knoeff, and M. Sellmeijer. 2011. Erosion in geomaterials. *European Journal of Environment and Civil Engineering* 15(8):1115-1137.
- Wagner, D. J. 2013. *Reading A for Class 05: Signal characteristics*. Rensselaer Polytechnic Institute. December 23, 2010. <http://www.rpi.edu/dept/phys/ScIT/InformationTransfer/sigtransfer/signalcharacteristics.html> (accessed August 30, 2012).
- Wahl, K. L., W. O. Thomas, Jr., and R. M. Hirsch. 1995. Stream gaging program of the U.S. Geological Survey, Data Collection Process. U.S. Geological Survey Circular 1123, U.S. Department of the Interior. Reston, VA: U.S. Geological Survey. <http://pubs.usgs.gov/circ/circ1123/collection.html>.
- Woerner, E. 2012. Using helicopter borne FLIR for targeting sand boils in flood fighting during 2011 Mississippi River flood. Personal communication. Vicksburg, MS: U.S. Army Engineer District, Vicksburg.
- Woldringh, R. F., M. O. O'Banion, C. Dean, M. T. van der Meer, and C. Spoorenberg. 2012. *High-tech advances in levee modeling and evaluation tools for flood risk management*. Boca Raton FL: CRC Press, Taylor & Francis Group, LLC.

- Won, I. J. 2003. Geometrical and frequency sounding principals. Geophex. Personal communication.
- Xia, J., R. D. Miller, and C. B. Park. 1999. Estimation of near-surface shear-wave velocity by inversion of Rayleigh waves. *Geophysics* 64(3):691-700.

Appendix A: Remote Sensing

11/21/2012

Alos-Palsar

- Goal: Collect global and high resolution land observation data
- Resolution: Panchromatic: 2.5m; Multispectral: 10m; SAR-L: 10m and 100m
- Sampling Rate: 2 days
- Band: L-Band, Blue, Green, Red, Near IR, PAN
- Launched: 2006

Source: <http://www.satimagingcorp.com/satellite-sensors/alos.html>

Aqua

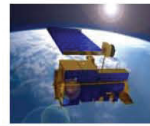
- Goal: Provide data about the Earth's water cycle
- Resolution: 250- 500 meters; 10 km
- Sampling Rate: 16 days
- Band: Visible, Infrared, Microwave
- Launched: 2002 (Part of the A-Train Constellation)

Source: http://www.nasa.gov/pdf/151986main_Aqua_brochure.pdf

11/21/2012

ASTER

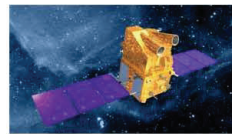
- Goal: Contribute to global change-related areas such as vegetation & ecosystem dynamics, hazard monitoring, geology & soils, land surface climatology, hydrology, land cover change, generation of digital elevation models
- Resolution: 15m, 30m, 90m
- Sampling Rate: 16 days
- Band: VNIR, SWIR, TIR
- Launched: 1999



Source: <http://www.satimagingcorp.com/satellite-sensors/aster.html>

CARTOSAT- 1

- Goal: Provide enhanced inputs for large scale mapping applications & stimulate newer applications in the urban & rural development, land & water resources management, disaster assessment, land cover change detection, relief planning & management, environmental impact assessment & various other GIS applications
- Resolution: 2.5 meters
- Sampling Rate: 116 days
- Band: X-Band
- Launched: 2005



Source and Image Credit: ISRO

Source: <http://www.satimagingcorp.com/satellite-sensors/cartosat-1.html>

11/21/2012

CBERS- 2

- Goal: (partnership between Brazil & China)
Images are used as deforestation and fire control in the Amazon Region, water resources monitoring, urban growth, soil occupation, education
- Resolution: 20 (at nadir)- 260 meters
- Sampling Rate: 26 days
- Band: Panchromatic, Blue, Green, Red, Near IR
- Launched: 2003



Source: <http://www.satimagingcorp.com/satellite-sensors/cbers-2.html>

Image Credit: China Brazil Earth Resources Satellite/INPE

CosmoSky- Med Constellation

- Goal: Provide data for environment, civil protection, oil and gas exploration, and surveillance
- Resolution: 15 meters
- Sampling Rate: 16 days
- Band: X-Band
- Launched: 2007- 2010

Source: <http://www.telespazio.it/cosmo.html>

11/21/2012

Deimos- 1

- Goal: Offer imagery for commercial applications, for government use, and for rapid-response following disasters
- Resolution: 22 meters
- Sampling Rate: Sun-synchronous near- circular
- Band: Multispectral
- Launched: 2009

Source: <https://earth.esa.int/web/guest/missions/3rd-party-missions/current-missions/deimos-1>

Envisat

- Goal: Provide continuous observation and monitoring of the Earth's land, atmosphere, oceans and ice caps; make contributions to environmental studies
- Resolution of 300m
- Sampling Rate: 35 days
- Bands: C-Band, Visible, Near IR
- Mission ended (lost contact): 2012

Source: <https://earth.esa.int/web/guest/missions/esa-operational-ee-missions/envisat/objectives>

11/21/2012

ERS1 (European Remote Sensing Satellite)

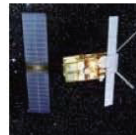
- Goal: Gather information about the Earth (land, water, atmosphere, ice)
- Resolution: 25x 25m
- Sampling Rate: 3 days, 35 days, 336 days
- Band: C-band
- Retired: March 2000



Source: <http://earth.esa.int/ers/satcon/>

ERS2

- Goal: Gather information about the Earth (land, water, atmosphere, ice)
- Resolution: 25x 25m
- Sampling Rate: 35 days
- Band: C-Band
- Retired: July 2011

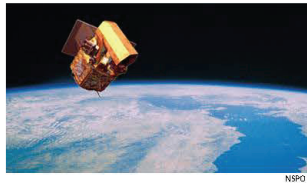


Source: <https://earth.esa.int/web/guest/missions/esa-operational-eo-missions/ers>

11/21/2012

FORMOSAT- 2

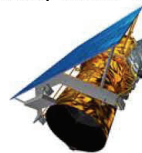
- Goal: Land distribution, natural resources research, forestry, environmental protection, disaster prevention, rescue work
- Resolution: panchromatic: 2m; multispectral: 8m
- Sampling Rate: Daily
- Bands: Panchromatic, Blue, Green, Red, Near IR
- Launched: 2004



Source: <http://www.satimagingcorp.com/satellite-sensors/formosat-2.html>

GeoEye- 1

- Goal: Has ability to locate an object within three meters of its physical location
- Resolution: Panchromatic: 0.41 m; Multispectral: 1.65 m
- Sampling Rate: 2.1- 3.8 days
- Band: Panchromatic, Blue, Green, Red, Near IR
- Launched: 2008



Source: <http://www.satimagingcorp.com/satellite-sensors/geoeye-1.html>

11/21/2012

GeoEye- 2

- Goal: Capable of discerning objects on the Earth's surface as small as 0.25 meters in size
- Resolution: 0.25 meters
- Sampling Rate: Daily?
- Band: Panchromatic, Blue, Green, Red, Near IR
- Launches: 2013

Source: <http://www.satimagingcorp.com/satellite-sensors/geoeye-2.html>

IKONOS- 2

- Goal: Provide high-resolution imagery on a commercial basis
- Resolution: Panchromatic: 0.82 meters;
Multispectral: 4 meters
- Sampling Rate: 3- 14 days
- Band: Panchromatic, Blue, Green, Red, Near IR
- Launched: 1999

Source: <https://earth.esa.int/web/guest/missions/3rd-party-missions/current-missions/ikonos-2>

11/21/2012

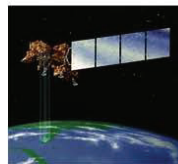
IRS- P6

- Goal: Provide continued remote sensing data services on an operational basis for integrated land and water resources management
- Resolution: Multispectral: 5.8 meters; Panchromatic: 23.5 meters
- Sampling Rate: 5 days
- Band: Panchromatic, Multispectral
- Launched: 2003

Source: <https://earth.esa.int/web/guest/missions/3rd-party-missions/current-missions/irs-p6>

LANDSAT 7

- Goal: Used to support agriculture, forestry, geography, geology, hydrology, mapping, oceanography, resource management
- Resolution: 15- 90 meters
- Sampling Rate: 16 days
- Band: Blue-green, green, red, NIR, Mid Infrared, Far Infrared
- Launched: 1999



Source: <http://www.satimagingcorp.com/satellite-sensors/landsat.html>

11/21/2012

OrbView 3

- Goal: designed to supply high-resolution imagery of the Earth
- Resolution: Panchromatic: 1 m;
Multispectral: 4 m
- Sampling Rate: < 3 days
- Band: Panchromatic, Multispectral
- Launched: 2003



Source: <http://www.orbital.com/SatellitesSpace/ImagingDefense/OV3/index.shtml>

Pleiades- 1

- Goal: Acquire high-resolution stereo imagery in just one pass
- Resolution: 0.5 meters
- Sampling Rate: Daily
- Band: Panchromatic, Blue, Green, Red, Near IR
- Launched: 2011



Source: <http://www.satimagingcorp.com/satellite-sensors/pleiades-1.html>

11/21/2012

Proba

- Goal: Provide high-resolution imaging up to five different viewing angles
- Resolution: 18 meters
- Sampling Rate: Sun-synchronous elliptical polar
- Band: Visible
- Launched: 2001

Source: <https://earth.esa.int/web/guest/missions/eo-sa-operational-eo-missions/proba>

QuickBird

- Goal: Provide environmental data useful for changes in land usage, agricultural, and forest climates
- Resolution: Panchromatic: 60 -70 cm; multispectral: 2.4- 2.8 meters
- Sampling Rate: 1- 3.5 days depending on latitude
- Band: Panchromatic, Blue, Green, Red, Near IR
- Launched: 2001



Source: <http://www.satimagingcorp.com/satellite-sensors/quickbird.html>

11/21/2012

Radarsat- 1

- Goal: Provide nearly complete global landmass coverage
- Resolution: 10- 100 meters
- Sampling Rate: Arctic: daily; Canada: every 72 hours; Earth: every 24 days
- Band: C-Band
- Launched: 1995

Source: <http://www.asc-csa.gc.ca/eng/satellites/radarsat1/components.asp>

Radarsat- 2

- Goal: Provide data that is valuable for major application areas in coastal and marine surveillance, and security and foreign policy
- Resolution: 3- 100 meters
- Sampling Rate: 24 days
- Band: C-Band
- Launched: 2007



Radarsat 2 (MDA)

Source: http://www.asc-csa.gc.ca/eng/satellites/radarsat2/inf_over.asp

11/21/2012

RapidEye

- Goal: Acquire high-resolution, large-area image data on a daily basis
- Resolution: 5 meters
- Sampling Rate: Daily (off nadir); 5.5 days (nadir)
- Band: Blue, Green, Red, Red Edge, Near IR
- Launched: 2008



Source: <http://www.satimagingcorp.com/satellite-sensors/rapideye.html>

RCM Constellation (RADARSAT Constellation Mission)

- Goal: Provide a large amount of data to government departments for operational monitoring over wide areas
- Resolution: < 1 m to 100 meters
- Sampling Rate: 12 days
- Band: C-Band
- Launches: 2016-2017

Source: <http://www.asc-csa.gc.ca/eng/satellites/radarsat/default.asp>

11/21/2012

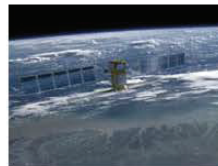
Saocom

- Goal: Provide polarimetric L band SAR information independently from the meteorological and day time conditions in different Earth zones
- Resolution: 10- 100 meters
- Sampling Rate: 16 days
- Band: L- Band
- Launches: 2012- 2013

<http://www.conae.gov.ar/eng/satellites/saocom.html>

SENTINEL 1

- Goal: Aid sea-ice monitoring
- Resolution: swath width of 250 km and a ground resolution of 5x20 m
- Sampling Rate: 1-3 days
- Band: C-Band
- Launches: 2013



Source: http://www.esa.int/esaLP/SEMBR54KXMF_LPgmes_0.html

11/21/2012

SENTINEL 2

- Goal: Provide data for land services
- Resolution: 4 bands at 10 m, 6 bands at 20 m and 3 bands at 60 m spatial resolution with a swath width of 290 km
- Sampling Rate: 5 days at equator; 2-3 days at mid-latitudes
- Band: C-Band
- Launches: 2013

Source: http://www.esa.int/esaLP/SEMM4T4KXMF_LPgmes_0.html

SENTINEL 3

- Goal: Provide services for marine environment
- Resolution: spatial resolution in the visible and shortwave infrared channels of 500 m and 1 km in the thermal infrared channels
- Sampling Rate: 27 day for topography package; 4 day sub-cycle
- Band: Ku, C-Band, Visible, Shortwave IR, Thermal IR
- Launches: 2013

Source: http://www.esa.int/esaLP/SEMTST4KXMF_LPgmes_0.html

11/21/2012

SENTINEL 4

- Planned to launch in 2019
- Goal: Beneficial to air monitoring services
- Resolution: 0.12 nm- 0.5 nm
- Sampling Rate: 1- 4 days over Europe and Africa
- Band: Ultraviolet, Visible, Near IR
- Launches: 2019

Source: http://www.esa.int/esaLP/SEM3ZT4KXMF_LPgmes_0.html

SENTINEL 5

- Goal: Beneficial to air monitoring services
- Resolution: 0.25- 1.0 nm
- Sampling Rate: 1- 4 days over Europe and Africa
- Band: Ultraviolet, Visible, Near IR, SWIR
- Launches: 2020

Source: http://www.esa.int/esaLP/SEM3ZT4KXMF_LPgmes_0.html

11/21/2012

SPOT-4

- Goal: Earth observation
- Resolution: 20 meters
- Sampling Rate: 26 days
- Band: Panchromatic, Visible, SWIR
- Launched: 1998



Source: <https://earth.esa.int/web/guest/missions/3rd-party-missions/current-missions/spot-4>

SPOT-5

- Goal: Used for medium scale mapping, urban and rural planning, oil and gas exploration, natural disaster management
- Resolution: Panchromatic: 5 m; Multispectral: 10 m; SWIR: 20 m
- Sampling Rate: 2- 3 days
- Band: Panchromatic, Green, Red, Near IR, SWIR
- Launched: 2002



Source: <http://www.satimagingcorp.com/satellite-sensors/spot-5.html>

11/21/2012

TanDEM- X

- Goal: Generate a global Digital Elevation Model (DEM) of unprecedented quality, accuracy, and coverage
- Resolution: 1- 16 meters
- Sampling Rate: 11 days
- Band: X- Band
- Launched: 2010



<http://www.astrium-geo.com/en/168-tandem-x-global-dem>

Terra

- Goal: Provide global observations and scientific understanding of land cover change and global productivity, climate variability and change, natural hazards, and atmospheric ozone
- Resolution: 250 m- 1 km
- Sampling Rate: 16 days
- Band: Visible, Near IR, Shortwave- IR, Thermal IR
- Launched: 1999

Source: http://www.nasa.gov/pdf/156294main_terra_sw_guide.pdf

11/21/2012

TerraSAR- X

- Goal: Provides high-resolution SAR imagery with a resolution of up to 1m independent of weather conditions and illumination
- Resolution: 1.8 x 3.4 meters
- Sampling Rate: every 11 days
- Band: X- Band
- Launched: 2007



Source: <http://www.astrium-geo.com/terrasar-x/>

UK- DMC- 2

- Goal: Provide data for rapid-response disaster monitoring and mitigation
- Resolution: 30- 40 meters
- Sampling Rate: 14 days
- Band: Multispectral
- Launched: 2009

Source: <https://earth.esa.int/web/guest/missions/3rd-party-missions/current-missions/uk-dmc>

11/21/2012

WorldView1

- Goal: Earth observation
- Resolution: 0.55 meters (nadir)
- Sampling Rate: 1.7- 5.9 days
- Band: Panchromatic
- Launched: 2007



Source: <http://www.satimagingcorp.com/satellite-sensors/worldview-1.html>

WorldView2

- Goal: Provide high resolution images for spectral analysis, mapping and monitoring applications, land-use planning, disaster relief, exploration, defense and intelligence, visualization and simulation environments
- Resolution: 1.8 meters (nadir); 2.4 (off-nadir)
- Sampling Rate: 1.1- 3.7 days
- Band: Panchromatic, Red, Blue, Green, Near IR, Red Edge, Coastal, Yellow, Near IR 2
- Launched: 2009



Source: <http://www.satimagingcorp.com/satellite-sensors/worldview-2.html>

Appendix B: EP 500-1-1 – Inspection Guide for Flood-Control Works

EP 500-1-1
30 Sep 01

APPENDIX B - INSPECTION GUIDE FOR FLOOD CONTROL WORKS

INSPECTION GUIDE FOR FLOOD CONTROL WORKS

Name of Project: _____ Date _____

Public Sponsor: _____

SUMMARY OF INSPECTION:
THE PROJECT CONDITION AS A RESULT OF THIS (INITIAL)(CONTINUING) *(circle one)*
ELIGIBILITY INSPECTION IS:

- ACCEPTABLE
- MINIMALLY ACCEPTABLE
- UNACCEPTABLE.

[NOTE: Refer to Page 10 of the Inspection Guide for Rating Codes for Individual Rated Items, and Project Condition Codes used in this inspection.]

CORPS OF ENGINEERS INSPECTORS:

PUBLIC SPONSOR REPRESENTATIVES

COMMENTS:

Check if additional comments are attached.

PAGE 1 OF 10

Figure B-1. Inspection Guide for Flood Control Works

B-1

EP 500-1-1
30 Sep 01

RATED ITEM	S	M	U	EVALUATION
SECTION I				FCW ENGINEERING - FOR USE DURING INITIAL ELIGIBILITY INSPECTION OF NONFEDERAL PROJECTS
1. Level of Protection				The designed section is for an exceedance frequency greater than 10% chance (10 yr.) with minimum freeboard of 2 feet/60 cm (urban levee) <i>or</i> the designed section is for an exceedance frequency between 20% to 10% chance (5-10 yr.) with minimum freeboard of 1 foot/30cm (agricultural levee).
2. Erosion Control			S	Erosion protection in active areas is capable of handling the designed flow velocity for the level of protection for the entire FCW.
			M	Erosion protection is capable of handling the designed flow velocity for the level of protection for 75% or more of the FCW.
			U	Erosion protection measures protect less than 75% of the FCW; or if erosion protection was not present and there is evidence indicating a need for erosion protection.
3. Embankment			S	Fill material for embankment is suitable to prevent slides and seepage for the existing side slopes. Fill material is uniform and adequately compacted through the entire FCW.
			M	Material is adequate and suitable to prevent major slides and capable of handling localized seepage for the existing side slopes. Fill material is uniform and adequately compacted in 75% or more of the FCW.
			U	Material is unsuitable and likely to cause numerous slides and allow excessive uncontrolled seepage. Fill material is not uniform, or there is no compaction and evidence indicates a need for compaction.
4. Foundation			S	Foundation materials will not cause piping, sand boils, seepage, or settlements that reduce the level of protection.
			M	Foundation materials may show signs of excessive seepage, minor sand boils, and localized settlements.
			U	Foundation materials are unsuitable and likely to cause excessive uncontrolled seepage, sand boils, and/or piping.
5. Structures			S	Structures are capable of performing their design functions and show no signs of failure.
			M	Structures are performing their design functions but show signs of overtopping and bypassing flows.
			U	Structures are not performing their design functions or show signs of structural failure.

PAGE 2 OF 10

EP 500-1-1
30 Sep 01

RATED ITEM	S	M	U	EVALUATION
SECTION II				FCW MAINTENANCE - FOR USE DURING ALL INSPECTIONS
6. Depressions				S Minimal depressions or potholes; proper drainage.
				M Some depressions that will not pond water.
				U Depressions 15 cm (6") vertical or greater which endangers the integrity of the levee.
7. Erosion				S No erosion observed.
				M LEVEE: Erosion of levee crown or slopes that will not interrupt inspection or maintenance access. OTHER FCW: Erosion gullies less than 15 cm (6 inches) deep or deviation of 30 cm (1 foot) from designed grade or section.
				U LEVEE: Erosion of levee crown or slopes that has interrupted inspection or maintenance access. OTHER FCW: Erosion gullies greater than 15 cm (6 inches) or deviation of 30 cm (1 foot) or more from designed grade or section.
8. Slope Stability				S No slides present. Erosion of slopes less than 10 cm (4") deep.
				M Minor superficial sliding that with deferred repair does not pose an immediate threat to FCW integrity. No displacement or bulges.
				U Evidence of deep seated sliding (60 cm (2 ft.) vertical or greater) requiring repairs to re-establish FCW integrity.
9. Cracking				S No cracks in transverse or longitudinal direction observed in the FCW.
				M Longitudinal cracks are no longer than the levee height. No displacement and bulging. No transverse cracks.
				U Longitudinal cracks are greater than levee height, with or without some bulging observed. Transverse cracks are evident
10. Animal Control				S Continuous animal burrow control program that eliminates any active burrowing in a short period of time. Program includes filling in of existing burrows.
				M Animal burrows present that will not result in seepage or slope stability problems.
				U Animal burrows present that would result in possible seepage or slope stability problems.

PAGE 3 OF 10

EP 500-1-1
30 Sep 01

RATED ITEM	S	M	U	EVALUATION
SECTION II - Continued				FCW MAINTENANCE - FOR USE DURING ALL INSPECTIONS
11. Unwanted Vegetation Growth			S	A- No large brush or trees exist in the FCW. Grass cover well maintained. CHANNELS: Channel capacity for designed flows is not affected.
			M	Minimal tree (5 cm (2") diameter or smaller) and brush cover present that will not threaten FCW integrity. (NOTE: Trees that have been cut and removed from levees should have their roots excavated and the cavity filled and compacted with impervious material). CHANNELS: Channel capacity for designed flows is not adversely affected.
			U	Tree, weed, and brush cover exists in the FCW requiring removal to re-establish or ascertain FCW integrity. (NOTE: If significant growth on levees exists, prohibiting rating of other levee inspection items, then the inspection should be ended until this item is corrected.) CHANNEL: Channel obstructions have impaired the floodway capacity and hydraulic effectiveness.
12. Encroachments			S	No trash, debris, excavations, structures, or other obstructions present.
			M	Trash, debris, excavations, structures, or other obstructions present, or inappropriate activities occurring that will not inhibit operations and maintenance performance.
			U	Trash, debris, excavations, structures or other obstructions present, or inappropriate activities that would inhibit operations and maintenance performance.
13. Riprap/Revetments/Banks			S	Existing protection works are being properly maintained and are undamaged.
			M	No scouring activity that could undercut banks/riprap, erode embankments, or restrict desired channel flow.
			U	Meandering and/or scour activity that is undercutting banks, eroding embankments, or impairing channel flows by causing turbulence, meandering, or shoaling.
14. Stability of Concrete Structures			S	Any tilting, sliding, or settling of structures, if present, has been secured, preserving the integrity or performance.
			M	Uncorrected sliding or settlement of structures of a magnitude that does not affect performance.
			U	Tilting or settlement of structures that has resulted with a threat to the structure's integrity and performance.

EP 500-1-1
30 Sep 01

RATED ITEM	S	M	U	EVALUATION
SECTION II - Continued				FCW MAINTENANCE - FOR USE DURING ALL INSPECTIONS
15. Concrete Surfaces			S	Negligible spalling or scaling. No cracks present that are not controlled by reinforcing steel or that cause integrity deterioration or result in inadequate structure performance.
			M	Spalling, scaling and cracking present but immediate integrity or performance of structure not threatened.
			U	Surface deterioration or deep, controlled cracks present that result in an unreliable structure.
16. Structural Foundations			S	No scouring or undermining near the structures.
			M	Scouring near the footing of the structure but not close enough to affect structure stability during the next flood event.
			U	Scouring or undermining at the foundation that has affected structure integrity.
17. Culverts			S	[a] No breaks, holes, cracks in the culvert that would result in any significant water leakage. No surface distress that could result in permanent damage. [b] Negligible debris or silt blocking culvert section. No or minimal debris or sediment present which has negligible effect on operations of the culvert.
			M	[a] Integrity not threatened by spalls, scales, or surface rusting. Cracks present but resulting leakage not affecting the structure. [b] Debris or sediment present, which is proposed to be removed prior to the next flood event, that minimally affects the operations of the culvert.
			U	[a] Culvert has deterioration such as surface distress and/or has significant leakage in quantity or degree to threaten integrity. [b] Accumulated debris or settlement which has not been annually removed and severely affects the operations of the culvert.
18. Gates			S	Gates open easily and close to a tight seal. Materials do not have permanent corrosion damage and appear to have historically been maintained adequately.
			M	Gates operate but leak when closed; however, leakage quantity is not a threat to performance. All appurtenances of the facility are in working condition.
			U	Gates leak significantly when closed or do not operate. Gates and appurtenances have damages that threaten integrity and/or appear not to have been maintained adequately.
19. Closure Structures			S	Closure structure in good repair. Placing equipment readily available at all times.
			U	Closure structure in poor condition. Parts missing. Placing equipment may not be available within normal warning time.

PAGE 5 OF 10

EP 500-1-1
30 Sep 01

RATED ITEM	S	M	U	EVALUATION
SECTION II - Continued				<i>FCW MAINTENANCE - FOR USE DURING ALL INSPECTIONS</i>
20. Motors			S	All motors, if present, are operational. Preventive maintenance is occurring and system is performance tested periodically.
			M	All motors are operational and minor discrepancies are such that motors could be expected to perform through the next projected period of usage.
			U	Motors are not operational, or noted discrepancies have not been corrected.
21. Power			S	Adequate, reliable, and enough capacity to meet demands.
			U	Power source not considered reliable to sustain operations during flood condition.
22. Metallic items			S	All metal parts in a plant/building protected from permanent damage from corrosion. Gates operable.
			M	Corrosion on metal parts appears maintainable. Gates operable.
			U	Metal parts need replacement, may fail, or will not function.
<p>REMARKS FOR SECTIONS I AND II.</p>				
				PAGE 6 OF 10

EP 500-1-1
30 Sep 01

RATED ITEM	S	M	U	EVALUATION
SECTION III				FOR USE DURING ALL INITIAL and CONTINUING ELIGIBILITY INSPECTIONS
23. Pump Station Size				Pump station has adequate capacity (considering pumping capacity, ponding areas, etc.) to handle expected inflow volumes.
SECTION IV				FOR USE DURING ALL INITIAL and CONTINUING ELIGIBILITY INSPECTIONS
24. Operations and Maintenance Manual				Operations and Maintenance (O&M) Manual is present and adequately covers all pertinent areas. All necessary updates to the Manual have been done.
25. Operating Log				Pump Station Operating Log is present and being used. Operators are trained on proper usage.
26. Annual Inspection				Annual inspection is being performed by the public sponsor.
27. Plant Building			S	Plant building is in good structural condition. No apparent major cracks in concrete, no subsidence, roof is not leaking, etc. Intake louvers clean, clear of debris. Exhaust fans operational and maintained. Safe working environment.
			M	Spalling and cracking are present, or minimal subsidence is evident, or the roof leaks, or other conditions are present that need repair but do not threaten the structural integrity or stability of the building.
			U	Any condition that does not meet Minimally Acceptable standard.
28. Pumps			S	All pumps are operational. Preventive maintenance and lubrication are being performed. System is periodically subjected to performance testing. No evidence of unusual sounds, cavitation, or vibration.
			M	All pumps are operational and deficiencies/minor discrepancies are such that pumps could be expected to perform through the next expected period of usage.
			U	One or more primary pumps are not operational, or noted discrepancies have not been corrected.
29. Motors, Engines, and Gear Reducers			S	All items are operational. Preventive maintenance and lubrication being performed. System is periodically subjected to performance testing. Instrumentation, alarms, and auto shutdowns are operational.
			M	All systems are operational and deficiencies/minor discrepancies are such that pumps could be expected to perform through the next expected period of usage.
			U	One or more primary motors are not operational, or noted deficiencies/discrepancies have not been corrected.

PAGE 7 OF 10

EP 500-1-1
30 Sep 01

RATED ITEM	S	M	U	EVALUATION
SECTION IV Continued				FOR USE DURING ALL PUMP STATION INSPECTIONS
30. Trash Rakes				S Drive chain, bearings, gear reducers, and other components are in good operating condition and properly maintained.
				M Drive chain, bearings, gear reducers, and other components are capable of performing as designed through the next flood event.
				U Proper operation would be inhibited during the next flood event.
31. Other Metallic Items				S All metal parts in plant/building are protected from permanent damage by corrosion. Equipment anchors show no rust or deterioration.
				M Corrosion on metallic parts (except equipment anchors) appears maintainable.
				U Any condition that does not meet at least Minimum Acceptable standards.
32. Insulation Megger Testing				S Results of megger test show that insulation meets manufacturer's or industry standard. Test not more than 24 months old.
				M Results of megger test show that insulation resistance is lower than manufacturer's or industry standard, but can be corrected with proper application of heat.
				U Insulation resistance is low enough to cause the equipment to not be able to meet its design standard of operation.
33. Power				S Adequate, reliable, and enough capacity to meet demands. Backup generators are on hand and deemed reliable, or feasible plan exists to obtain backup power. Backup units are properly sized, operational, periodically exercised, and properly maintained.
				U Power source not considered reliable to sustain operations during flood condition.
34. Pump Control System				S Operational and maintained free of damage, corrosion, or other debris.
				M Operational with minor discrepancies. Will function adequately in the next flood event.
				U Not operational; uncorrected discrepancies noted from previous inspections; capability to adequately function in the next flood event is suspect.
35. Sumps				S Clear of debris and obstructions. Mechanisms are in place to maintain this condition during operations.
				M Clear of large debris, minor obstructions present. Mechanisms are in place to deter any further accumulation during operation. Sump will function as intended.
				U Large debris or major obstructions present, or no mechanism exists to prevent debris accumulation during operation.

EP 500-1-1
30 Sep 01

RATED ITEM	S	M	U	EVALUATION
SECTION IV - Continued				<i>FOR USE DURING ALL PUMP STATION INSPECTIONS</i>
36. Intake/Discharge Gates.				Functional. Electric operators maintained. (S or U only.)
37. Cranes				Operational. Inspected and load tested in accordance with OSHA requirements. (S or U only.)
38. Telephone Communications				Telephone communication is available in the pump station. Alternatively, two-way radio, cellular telephone, or similar device is available, or, access to a telephone is within a reasonable driving distance. (S or U only.)
39. Safety				No exhaust leaks in building. Fuel storage/distribution meets state/local requirement. Fire extinguishers on hand, of sufficient quantity, and properly charged. Safety hardware installed. Required safety items (e.g., aural protectors) used. (S or U only.)
Remarks for Pump Station - Sections III and IV of Inspection Guide.				
				PAGE 9 OF 10

EP 500-1-1
30 Sep 01

Instructions and Information for the Inspection Guide

RATINGS: The following terms and definitions are used in the conduct of this inspection for rating items and components of this project:

S - Satisfactory: The rated item is in satisfactory condition, and will function as designed and intended during the next flood event.

M - Marginally Satisfactory: The rated item has a minor deficiency that needs to be corrected. The minor deficiency will not seriously impair the functioning of the item during the next flood event. The overall reliability of the project will be lowered because of the minor deficiency.

U - Unsatisfactory: The rated item is unsatisfactory. The deficiency is so serious that the item will not adequately function in the next flood event, compromising the project's ability to provide reliable flood protection.

DETERMINATION OF PROJECT CONDITION CODE: The lowest single rating given for a rated item will determine the overall condition of the project. If all rated items are rated as Satisfactory, the project condition will be Acceptable. If one or more rated items are evaluated as Marginally Satisfactory, with no rated items evaluated as Unsatisfactory, then the project condition will be Minimally Acceptable. One or more rated items with a rating of Unsatisfactory will result in a project condition of Unacceptable.

STATUS: Acceptable and Minimally Acceptable projects are in Active status. Unacceptable projects are in Inactive status. Projects in Inactive status are not eligible for consideration for Rehabilitation Assistance from the US Army Corps of Engineers in the event of damage from a flood or coastal storm.

GENERAL INSTRUCTIONS.

1. Section I will be used on all IEI's.
2. Section II will be used on all CEI's.
3. All rated items in Sections I and II must have a rating given.
4. Additional areas for inspection will be incorporated by the inspector into this guide if the layout or physical characteristics of the project warrant this. Appropriate entries will be made in the REMARKS block.

FOR PROJECTS WITH PUMP STATIONS:

5. Section III and IV will be used on all IEI's and CEI's for projects with pump stations. A pump station must have the primary purpose of flood control, not interior drainage. The district will determine, based on appropriate study, if adequate capacity exists. Lack of adequate capacity mandates a rating of Unsatisfactory and a condition of Unacceptable.
6. The lowest rating for a rated item on either the levee inspection (Sections I and II) or the pump station (Sections III and IV) determines the overall project condition.
7. A non-Federal pump station located behind a Federal levee will be treated as a separate FCW, will not be incorporated into the Federal levee project, and will be inspected as a separate entity. The lowest rated item on the pump station inspection determines the project condition code for the pump station. This is independent of the Federal project inspection.
8. Additional areas for inspection will be incorporated by the inspector into this guide if the layout or physical characteristics of the pump station warrant this. Appropriate entries will be made in the REMARKS block.

PAGE 10 OF 10

Basic Eligibility
 For use only during Initial Eligibility Inspections of Non-Federally Constructed Flood Control Works

RATED ITEM	A			M			U			N/A			EVALUATION	LOCATIONS/REMARKS/RECOMMENDATIONS
1. Public Sponsor (A or U only)													A The Public Sponsor is a legally constituted public body with full authority and capability to perform the terms of its agreement as the non-Federal partner of the Corps for a project, able to pay damages, if necessary, in the event of its failure to perform. The public sponsor may be a State, County, City, Town, Federally recognized Indian Tribe or tribal organization, Alaska Native Corporation, or any political subpart of a State or group of states that has the legal and financial authority and capability to provide the necessary cash contributions and the lands, easements, rights-of-way, relocations, and borrow and dredged or excavated materials disposal areas (LERRD's) necessary for the project, and who could legally hold and save the Federal government free from damages that could potentially arise during post-flood rehabilitations or other work on the FCW.	
2. Flood Protection (A or U only)													U The project does not have a public sponsor as defined above. A The principal function of the project is to protect people or property from floods. U The project was built or is primarily used for channel alignment, recreation, fish and wildlife, land reclamation, drainage, to protect against land erosion or tidal inflows, or for some other non-flood related purpose.	
3. Project Completion (A or U only)													A Project construction has been completed. U The project is still under construction.	
4. Construction Compliance (A or U only)													A Appropriate local, State, tribal, and/or Federal permits (right-of-way, easements, regulatory permits, etc.), or waivers thereof, have been obtained for FCW construction and subsequent modifications. The project was constructed in accordance with all applicable Federal, state and local codes, ordinances, and applicable laws. U The appropriate permits (or waivers thereof) have not been obtained for the project, or the project was not constructed in accordance with applicable codes, ordinances, and laws.	

Key: A = Acceptable, M = Minimally Acceptable, Maintenance is required, U = Unacceptable, N/A = Not Applicable, RODI = Requires Operation During Inspection

FCW Engineering
 For use only during Initial Eligibility Inspections of Non-Federally Constructed Flood Control Works

RATED ITEM	A			M			U			N/A			EVALUATION	LOCATIONS, REMARKS, RECOMMENDATIONS
1. Minimum Elevation (A or U only) (See instructions)													A • Urban Levees and Floodwalls - Minimum elevation corresponding to a flood level with 10% probability of occurring in a given year (10-year flood). • Agricultural Levees and Floodwalls - Minimum elevation corresponding to a flood level with 20% probability of occurring in a given year (5-year flood). • Flood Control Channels - Minimum capacity is for a flood with a 10% probability of occurring in a given year (10-year flood). Improved channels must additionally provide drainage for at least 1.5 square miles of land and have a capacity of at least 800 cfs. (NOTE: Interior drainage channels within the protected area of a levee system are not flood control channels.) U The FCW does not meet requirements for minimum elevation, capacity, or drainage area.	
2. Physical Location and Cross Section (A or U only)													A The physical location, cross section, and other design elements of the FCW are sufficient to provide reliable flood protection. The FCW is (or is an element of) a closed system, tied into high ground. U The FCW was not constructed in an appropriate location, does not have an appropriate cross section; is not properly tied into high ground, or has other shortcomings with design elements necessary for providing reliable flood protection. A Embankment material is suitable to prevent slides and seepage problems. U Embankment material is unsuitable and is likely to contribute to the development of slides or seepage problems.	
3. Embankment Fill													A Fill material is uniform and adequately compacted throughout the entire FCW. M Fill material is not uniform, or there is no compaction and evidence indicates a need for compaction.	
4. Embankment Material Uniformity/Compactness													A Foundation material will not cause piping, sand boils, seepage, or settlements that will reduce the level of protection. M Foundation material may show signs of excessive seepage, minor sand boils, and localized settlement. U Foundation materials are unsuitable and likely to cause excessive uncontrolled seepage, sand boils, and / or piping.	
5. Foundations													N/A The foundation problems described above do not apply to this type of FCW. A In the case of a levee project, the levee is a primary levee or is a secondary levee which is designed to protect human life or was designed as a major component of the primary levee system, necessary to assure the flood control protection of the total system. U The levee is a secondary levee, and was not designed to protect human life or as a major component of the primary levee system. N/A The FCW is not a levee system.	
6. Primary Levee														

Key: A = Acceptable M = Minimally Acceptable; Maintenance is required U = Unacceptable N/A = Not Applicable RODI = Requires Operation During Inspection

FCW Engineering (continued)
 For use only during Initial Eligibility Inspections of Non-Federally Constructed Flood Control Works

RATED ITEM	A			M			U			N/A			EVALUATION	LOCATIONS, REMARKS, RECOMMENDATIONS	
7. Interior Drainage System (including culverts, gates, pump stations)													A	Given the level of protection provided by the FCW, interior drainage structures are appropriately sized, situated, and constructed to move anticipated runoff and seepage out of the protected area. Pump stations will not become inundated during regular operation and their power system is adequately designed and reliable.	
													U	Interior drainage structures are undersized, poorly constructed, poorly situated, or unreliably designed.	
													N/A	The issue of interior drainage does not apply to this type of FCW.	
8. Structures													A	Structures are capable of performing their designed functions and show no signs of failure.	
													M	Structures are performing their design functions but show signs of overtopping and bypassing flows.	
													U	Structures are not performing their designed functions or show signs of potential structural failure.	
9. Erosion Control													A	Erosion protection is capable of handling the designed flow velocity for the level of protection for the entire FCW. The FCW is protected against bank caving and slides in all necessary areas, and has adequate drainage to protect FCW slopes from runoff erosion.	
													M	Erosion protection is capable of handling the designed flow velocity for the level of protection for 75% or more of the FCW.	
													U	Erosion protection measures protect less than 75% of the FCW. Erosion protection is not present and there is evidence indicating a need for erosion protection.	

Key: A = Acceptable, M = Minimally Acceptable, Maintenance is required, U = Unacceptable, N/A = Not Applicable, RODI = Requires Operation During Inspection

General Items for All Flood Control Works
 For use during Initial and Continuing Eligibility Inspections of all Flood Control Works

RATED ITEM	A			M			U			N/A			EVALUATION	LOCATIONS, REMARKS, RECOMMENDATIONS
1. Project Operations and Maintenance Manual (A or U only)													A Levee Owner's Manual, ICW O&M Manuals, and/or manufacturer's operating instructions are present.	
													U These manuals are lost or missing.	
2. Emergency Supplies and Equipment													A The sponsor maintains a stockpile of sandbags, shovels, and other flood fight supplies which will adequately supply all needs for the initial days of a flood fight.	
													M The sponsor does not maintain an adequate supply of flood fighting materials as part of their preparedness activities.	
3. Flood Preparedness and Training (A or M only)													A Sponsor has a solid understanding of how to operate, maintain, and staff the FCW during a flood, and has written plans that include information such as low spots or sand boils. The sponsor also has plans that cover short term situations. (For instance, if a culvert through the levee is being replaced, then the sponsor knows how to respond to a flood while the levee integrity is lacking due to the construction.)	
													M The sponsor maintains a good working knowledge of flood response activities, but there are insufficient plans to address project specific features or short term situations, or the knowledge of flood response activities is maintained by a very small number of individuals within the community. Additional planning or training is required to ensure the success of the FCW during a flood event.	

Key: A = Acceptable, M = Minimally Acceptable, Maintenance is required, U = Unacceptable, NA = Not Applicable, RODI = Requires Operation During Inspection

Levees
 For use during all Initial and Continuing Eligibility Inspections of levees

RATED ITEM	A			M			U			N/A	EVALUATION	LOCATIONS/REMARKS/RECOMMENDATIONS
1. Sod Cover											<p>A There is good coverage of sod cover over the levee.</p> <p>M Approximately 25% of the sod cover is missing or damaged over a significant portion or over significant portions of the levee embankment. This may be the result of over-grazing or feeding on the levee, unauthorized vehicular traffic, chemical or insect problems, or burning during inappropriate seasons.</p> <p>U Over 50% of the sod cover is missing or damaged over a significant portion or over significant portions of the levee embankment. This may be the result of over-grazing or feeding on the levee, unauthorized vehicular traffic, chemical or insect problems, or burning during inappropriate seasons.</p>	
2. Unwanted Vegetation Growth											<p>A The levee has a good grass cover with little or no unwanted vegetation (trees, bushes, or undesirable weeds) and has been recently mowed. Except in those cases where a vegetation variance has been granted by the Corps, a 5 meter (15') zone, free from all woody vegetation, is maintained adjacent to the landward/ riverside toe of the FCW for maintenance and flood-fighting activities. Additionally, a 1 meter (3') root free zone is maintained to protect the external limits of the levee cross section. Reference EM 1110-2-301 and/or local Corps policy.</p> <p>M Minimal number of trees (5 cm (2") diameter or smaller) and/or brush present on the levee or within the 5 meter (15') zone, that will not threaten the integrity of the project but which need to be removed.</p> <p>U Tree, weed, and brush cover exists in the FCW requiring removal to reestablish or ascertain FCW integrity. (NOTE: If significant growth on levees exists, prohibiting the inspection of animal burrows or other inspection items, then the levee inspection should be ended until this item is corrected.)</p>	
3. Depressions/ Rutting											<p>A There are no ruts, pot holes, or other depressions on the levee, except for minor depressions caused by levee settlement. The levee crown, embankments, and access road crowns are well established and drain properly without any ponded water.</p> <p>M Some minor depressions in the levee crown, embankment, or access roads that will not pond water and do not threaten the integrity of the levee.</p> <p>U There are depressions greater than 15 cm (6 inches) deep that will pond water, endangering the integrity of the levee.</p>	
4. Erosion/ Bank Caving											<p>A No active erosion or bank caving observed on the landward or on the riverward side of the levee.</p> <p>M There are areas where active erosion is occurring or has occurred on or near the levee embankment, but levee integrity is not threatened.</p> <p>U Erosion or caving is occurring or has occurred that threatens the stability and integrity of the levee. The erosion or caving has progressed into the levee section or into the extended footprint of the levee foundation and has compromised the levee foundation stability.</p>	

Key: A = Acceptable, M = Minimally Acceptable, Maintenance is required, U = Unacceptable, N/A = Not Applicable, RODI = Requires Operation During Inspection

Levees (continued)
 For use during all Initial and Continuing Eligibility Inspections of levees

RATED ITEM	A			M			U			N/A			EVALUATION	LOCATIONS, REMARKS, RECOMMENDATIONS
5. Slope Stability												A No slides present.		
												M Minor superficial sliding that with deferred repairs will not pose an immediate threat to FCW integrity.		
												U Evidence of deep seated sliding that threatens FCW integrity. Repairs are required to reestablish FCW integrity.		
6. Cracking												A No cracking observed on the levee greater than 15 cm (6 inches) deep.		
												M Longitudinal and/or transverse cracking greater than 15 cm (6 inches) deep. No evidence of vertical movement along the crack.		
												U Longitudinal and/or transverse cracking present and exhibits signs of vertical movement.		
7. Animal Control												A Continuous animal burrow control program in place that includes the elimination of active burrowing and the filling in of existing burrows.		
												M The existing animal burrow control program needs to be improved. Several animal burrows present which may lead to seepage or slope stability problems, and they require immediate attention.		
												U Animal burrow control program is not effective or is nonexistent. Significant maintenance is required to fill existing burrows, and the levee will not provide reliable flood protection until this maintenance is complete.		
8. Encroachments												A No trash, debris, excavations, structures, or other obstructions present within the project easement area. Encroachments which do not diminish proper functioning of the project have been previously approved by the Corps.		
												M Trash, debris, excavations, structures, or other obstructions present, or inappropriate activities that will not inhibit project operations and maintenance or emergency operations. Encroachments have not been approved by the Corps.		
												U Trash, debris, excavation, structures, or other obstructions present, or inappropriate activities that will inhibit project operations and maintenance or emergency operations.		
9. Riprap Revetments & Banks												A Existing riprap protection is properly maintained and is undamaged. Riprap clearly visible.		
												M No riprap displacement or scouring activity that could undercut banks, erode embankments, or restrict desired flow. Unwanted vegetation must be cleared and sprayed with an appropriate herbicide.		
												U Dense brush, trees, or grasses hide the rock protection, or meandering and/or scour activity is undercutting banks, eroding embankments, or impairing channel flows by causing turbulence or shoaling.		
												N/A There is no riprap protecting the levee.		

Key: A = Acceptable, M = Minimally Acceptable, Maintenance is required, U = Unacceptable, N/A = Not Applicable, RODI = Requires Operation During Inspection

Levees - Continued on Next Page

Levees (continued)
 For use during all Initial and Continuing Eligibility Inspections of levees

RATED ITEM	A			M			U			N/A			EVALUATION	LOCATIONS/REMARKS/RECOMMENDATIONS
10. Closure Structures (Stop Log, Earthen Closures, or Gates) (A or U only)													A Closure structure in good repair. Placing equipment, stoplogs, and other materials are readily available at all times. Components of closure clearly marked and installation instructions / procedures readily available.	
													U Closure structure in poor condition. Parts missing or corroded. Placing equipment may not be available within normal warning time.	
													N/A There are no closure structures along the levee.	
11. Underseepage Relief Wells/Toe Drainage Systems													A Toe drainage systems and pressure relief wells necessary for maintaining FCW stability during flood events functioned properly during the last flood event and no sediment is observed in horizontal system (if applicable). Nothing is observed which would indicate that the system won't function properly during the next flood.	
													M Toe drainage systems or pressure relief wells are damaged and may become clogged if they are not repaired.	
													U Toe drainage systems or pressure relief wells necessary for maintaining FCW stability during flood events have fallen into disrepair or have become clogged.	
													N/A There are no relief wells/ toe drainage systems along the levee.	

Key: A = Acceptable, M = Minimally Acceptable, Maintenance is required, U = Unacceptable, N/A = Not Applicable, RODI = Requires Operation During Inspection

Additional issues noted during the inspection:

Concrete Floodwalls
 For use during all Initial and Continuing Eligibility Inspections of concrete floodwalls

RATED ITEM	EVALUATION			LOCATIONS, REMARKS, RECOMMENDATIONS
	A	M	U	
1. Concrete Surfaces				<p>A Negligible spalling, scaling or cracking. If the concrete surface is weathered, rough to the touch, or holds moisture, it is still satisfactory but should be seal coated to prevent freeze/thaw damage.</p> <p>M Spalling, scaling, and open cracking present, but the immediate integrity or performance of the structure is not threatened. Reinforcing steel may be exposed. Repairs/ sealing is necessary to prevent additional damage during periods of thawing and freezing.</p> <p>U Surface deterioration or deep, controlled cracks present that result in an unreliable structure.</p>
2. Tilting, Sliding or Settlement of Concrete and Sheet Pile Structures				<p>A There are no significant areas of tilting, sliding, or settlement that would endanger the integrity of the project.</p> <p>M There are areas of tilting, sliding, or settlement (either active or inactive) that need to be repaired. The integrity of the structure is not in danger.</p> <p>U There are areas of tilting, sliding, or settlement (either active or inactive) that threaten the structure's integrity and performance.</p>
3. Foundation of Concrete and Sheet Pile Structures				<p>A No scouring / erosion, or undermining near the structure.</p> <p>M Scouring / erosion near the footing of the structure but not close enough to affect structure stability during the next flood.</p> <p>U Scouring or undermining at the foundation that has affected structural integrity.</p>
4. Monolith Joints				<p>A The monolith joint material is in good condition.</p> <p>M The monolith joint material is deteriorating and needs to be repaired or replaced to prevent spalling and cracking during freeze/thaw cycles.</p> <p>U The monolith joint material is severely deteriorated and the concrete has spalled and cracked, damaging the waterstop to the point where it will not provide the intended level of protection during a flood.</p> <p>N/A There are no monolith joints in the floodwall.</p>
5. Erosion/ Bank Caving				<p>A No active erosion or bank caving on the riverward side of the floodwall which might endanger its stability.</p> <p>M There are areas where the ground is eroding towards the base of the floodwall and efforts need to be taken to slow and repair this erosion, but the erosion has not yet progressed to the point that the floodwall will lose stability during a flood event.</p> <p>U Erosion or bank caving is occurring or has occurred riverward of the levee which threatens the stability of the floodwall.</p>

Key: **A** = Acceptable **M** = Minimally Acceptable, Maintenance is required **U** = Unacceptable **N/A** = Not Applicable **RODI** = Requires Operation During Inspection

Concrete Floodwalls- Continued on the next page

Concrete Floodwalls (continued)
 For use during all Initial and Continuing Eligibility Inspections of concrete floodwalls

RATED ITEM	EVALUATION			LOCATIONS, REMARKS, RECOMMENDATIONS
	A	M	U	
6. Unwanted Vegetation Growth				A A grass-only zone is maintained on both sides of the floodwall. All trees, brush, and unwanted vegetation have been removed from this zone for maintenance, flood-fighting activities, and to protect the floodwall. The grass-only zone extends from the concrete wall to a point 2.5 meters (8') beyond the underground toe and heel of the floodwall. Reference EM 1110-2-30 and/or local Corps policy.
				M There are some areas where unwanted vegetation is growing near the floodwall. This vegetation must be removed, but does not currently threaten the integrity of the project.
7. Encroachments				U There is a significant amount of tree, weed, or brush growth near the floodwall, which may limit access during flood fight operations or the roots of which may offer accelerated seepage paths under the structure.
				A No trash, debris, excavations, structures, or other obstructions present within the project easement area. Encroachments which do not diminish proper functioning of the project have been previously approved by the Corps.
				M Trash, debris, excavations, structures, or other obstructions present, or inappropriate activities that will not inhibit project operations and maintenance or emergency operations. Encroachments have not been approved by the Corps.
8. Closure Structures (Stop Log Closures and Gates) (A or U only)				U Trash, debris, excavation, structures, or other obstructions present, or inappropriate activities that will inhibit project operations and maintenance or emergency operations.
				A Closure structure in good repair. Placing equipment, stoplogs, and other materials are readily available at all times. Components of closure clearly marked and installation instructions / procedures readily available.
				U Closure structure in poor condition. Parts missing or corroded. Placing equipment may not be available within normal warning time.
9. Underseepage Relief Wells/ Toe Drainage Systems				N/A There are no closure structures along the floodwall.
				A Toe drainage systems and pressure relief wells necessary for maintaining FCW stability during flood events functioned properly during the last flood event and no sediment is observed in horizontal system (if applicable). Nothing is observed which would indicate that the system won't function properly during the next flood.
				M Toe drainage systems or pressure relief wells are damaged and may become clogged if they are not repaired.
				U Toe drainage systems or pressure relief wells necessary for maintaining FCW stability during flood events have fallen into disrepair or have become clogged.
				N/A There are no relief wells/ toe drainage systems along the floodwall.

Key: A = Acceptable; M = Minimally Acceptable; Maintenance is required; U = Unacceptable; NA = Not Applicable; RODI = Requires Operation During Inspection

Additional issues noted during the inspection:

Interior Drainage System
 For use during all Initial and Continuing Eligibility Inspections of systems carrying interior drainage through the FCW

RATED ITEM	A			M			U			N/A			EVALUATION	LOCATIONS, REMARKS, RECOMMENDATIONS
1. Vegetation and Obstructions												A Minimal, scattered obstructions or vegetation. The flow is not impeded.		
												M Log jams, snags, vegetation growth (such as cat tails, bull rushes, bushes, or saplings), or other obstructions block approximately 25% of the FCW.		
												U Log jams, snags, vegetation growth (such as cat tails, bull rushes, bushes, or saplings), or other obstructions block approximately 50% of the FCW.		
2. Encroachments												A No trash, debris, excavations, structures, or other obstructions present within the project easement area. Encroachments which do not diminish proper functioning of the project have been previously approved by the Corps.		
												M Trash, debris, excavations, structures, or other obstructions present, or inappropriate activities that will not inhibit project operations and maintenance or emergency operations. Encroachments have not been approved by the Corps.		
												U Trash, debris, excavation, structures, or other obstructions present, or inappropriate activities that will inhibit project operations and maintenance or emergency operations.		
3. Riprap Revetments of Inlet/ Discharge Areas												A Existing riprap protection is properly maintained and is undamaged. Riprap clearly visible.		
												M No riprap displacement or scouring activity that could undercut banks, erode embankments, or restrict desired flow. Unwanted vegetation must be cleared and sprayed with an appropriate herbicide.		
												U Dense brush, trees, or grasses hide the rock protection, or meandering and/or scour activity is undercutting banks, eroding embankments, or impairing channel flows by causing turbulence or shoaling.		
4. Erosion of Inlet/ Discharge Areas												N/A There is no riprap protecting the interior drainage system, or the riprap is discussed in another section.		
												A No active erosion or bank caving observed on the landward or on the riverward side of the levee.		
												M There are areas where active erosion is occurring or has occurred on or near the levee embankment, but levee integrity is not threatened.		
												U Erosion or caving is occurring or has occurred that threatens the stability and integrity of the levee. The erosion or caving has progressed into the levee section or into the extended footprint of the levee foundation and has compromised the levee foundation stability.		
												N/A There are no inlet/discharge areas.		

Key: A = Acceptable, M = Minimally Acceptable, Maintenance is required, U = Unacceptable, N/A = Not Applicable, RODI = Requires Operation During Inspection

Interior Drainage - Continued on Next Page

Interior Drainage System (continued)
 For use during all Initial and Continuing Eligibility Inspections of systems carrying interior drainage through the FCW

RATED ITEM	A			M			U			N/A			EVALUATION	LOCATIONS, REMARKS, RECOMMENDATIONS	
5. Blockage of Culverts (Inlets, Sump, and Discharge Areas)													A	There is little or no debris, sediment, or vegetation blocking the culverts, inlets, sump, or discharge areas. The channel capacity for designed flow is not affected.	
													M	Debris, sediment, or vegetation blocks less than 10 percent of the culvert opening, but must be removed.	
													U	Accumulated debris, sediment, or vegetation blocks more than 10 percent of the culvert opening, impairing the culvert's capacity and hydraulic effectiveness.	
6. Culverts													N/A	There are no culverts.	
													A	There are no breaks, holes, cracks in the culvert that would result in significant water leakage. Corrugated metal pipes, if present, are in good condition or have been relined with appropriate material, which is still in good condition.	
													M	There are breaks, holes, cracks in the culvert that would result in water leakage and need to be repaired, but do not threaten the integrity of the project. Corrugated metal pipes, if present, are showing deterioration but the entire length of pipe is still structurally sound and is not in danger of collapsing.	
8. Trash Racks (non-mechanical)													U	Culvert has deterioration and/or has significant leakage such that it threatens the integrity of the FCW. Corrugated metal pipes are in danger of collapsing or have already begun to collapse.	
													N/A	There are no culverts.	
													A	Trash racks are fastened in place and properly maintained.	
9. Flap Gates/Flap Valves/Pinch Valves RODI													M	Trash racks are in place but are unfastened or have bent bars that allow debris to enter into the pipe or pump station. Repair or replacement is required.	
													U	Trash rack is missing or damaged to the extent that it is no longer functional and must be replaced.	
													N/A	There are no trash racks.	
													A	Flap gates open and close easily with minimal leakage.	
													M	Gates show no corrosion damage and have been maintained.	
													U	Gate will not fully open or close because of obstructions that can be easily removed, or has corrosion damage that requires maintenance.	
													U	Gate is missing, has been damaged, or has deteriorated and needs repair.	
													N/A	There are no flap gates.	

Key: A = Acceptable, M = Minimally Acceptable, Maintenance is required, U = Unacceptable, N/A = Not Applicable, RODI = Requires Operation During Inspection

Interior Drainage System (continued)
 For use during all Initial and Continuing Eligibility Inspections of systems carrying interior drainage through the FCW

RATED ITEM	A	M	U	N/A	EVALUATION	LOCATIONS, REMARKS, RECOMMENDATIONS
10. Sluice / Slide Gates RODI					<p>A Gates open and close freely with minor leakage. Still is free of sediment and other obstructions. Gates and lifters have been maintained.</p> <p>M Gates have been damaged or have deteriorated, and open and close with resistance or binding. Leakage quantity is controllable and is not a threat to project performance. Maintenance is required.</p> <p>U Gates do not open or close. Gate, stem, lifter and/or guides may be damaged or corroded.</p> <p>N/A There are no sluice/ slide gates.</p>	
11. Electric Gate Operators for Sluice / Slide Gates RODI					<p>A All electric gate operators are in good working condition and are adequately powered, and are capable of opening and closing the gate properly. Preventative maintenance is being performed and the system is tested periodically.</p> <p>M All electric gate operators are operational with minor deficiencies, but should perform through the next period of usage.</p> <p>U The electric gate operators are not operational, or the power source is not considered reliable to sustain operations during flood conditions.</p> <p>N/A There are no electric gate operators.</p>	
12. Manual Operators (Backups) for Sluice / Slide Gates RODI					<p>A All manual gate operators are in good working condition and are capable of opening and closing the gate properly. Preventative maintenance is being performed and the system is tested periodically.</p> <p>M Manual gate operators are operational with minor deficiencies, but should perform through the next period of usage.</p> <p>U Manual gate operators are not operational.</p> <p>N/A If there are sluice or slide gates, there needs to be means of operating them manually. If there are no sluice/ slide gates, this item is N/A.</p>	
13. Concrete Surfaces (Such as gate wells, outfalls, intakes, or culverts)					<p>A Negligible spalling, scaling or cracking. If the concrete surface is weathered, rough to the touch, or holds moisture, it is still satisfactory but should be seal coated to prevent freeze/ thaw damage.</p> <p>M Spalling, scaling, and open cracking present, but the immediate integrity or performance of the structure is not threatened. Reinforcing steel may be exposed. Repairs/ sealing is necessary to prevent additional damage during periods of thawing and freezing.</p> <p>U Surface deterioration or deep, controlled cracks present that result in an unreliable structure.</p> <p>N/A There are no concrete surfaces.</p>	

Key: A = Acceptable, M = Minimally Acceptable, Maintenance is required, U = Unacceptable, N/A = Not Applicable, RODI = Requires Operation During Inspection

Interior Drainage System (continued)
 For use during all Initial and Continuing Eligibility Inspections of systems carrying interior drainage through the FCW

RATED ITEM	A			M			U			N/A			EVALUATION	LOCATIONS, REMARKS, RECOMMENDATIONS
14. Tilting, Sliding or Settlement of Concrete and Sheet Pile Structures (Such as gate wells, outfalls, intakes, or culverts)													A There are no significant areas of tilting, sliding, or settlement that would endanger the integrity of the project.	
													M There are areas of tilting, sliding, or settlement (either active or inactive) that need to be repaired. The integrity of the structure is not in danger.	
													U There are areas of tilting, sliding, or settlement (either active or inactive) that threaten the structure's integrity and performance.	
15. Foundation of Concrete Structures (Such as gate wells, outfalls, or culverts)													N/A There are no concrete structures.	
													A No scouring / erosion, or undermining near the structure.	
													M Scouring / erosion near the footing of the structure but not close enough to affect structure stability during the next flood.	
16. Safety Fencing RODI													U Scouring or undermining at the foundation that has affected structural integrity.	
													N/A There are no concrete structures.	
													A Safety/ security fencing is in good condition and provides protection against falling or unauthorized access. Gates open and close freely, locks are in place, and there is little corrosion on metal parts.	
17. Other Metallic Items													M Safety/ security fencing or gates are damaged or corroded but appear to be maintainable. Locks may be missing or damaged.	
													U Safety/ security fencing and gates are damaged or corroded to the point that replacement is required, or potentially dangerous project features are not secured.	
													N/A There are no features of the internal drainage system that require safety fencing.	
													A All metal parts are protected from corrosion damage, and show no rust, damage, or deterioration that would cause a safety concern.	
													M Corrosion seen on metallic parts appear to be maintainable.	
													U Metallic parts are severely corroded and require replacement to prevent failure, equipment damage, or safety issues.	
													N/A There are no other significant metallic items associated with the interior drainage system.	

Key: A = Acceptable, M = Minimally Acceptable, Maintenance is required, U = Unacceptable, N/A = Not Applicable, RODI = Requires Operation During Inspection

Additional issues noted during the inspection:

Pump Stations
For use during all Initial and Continuing Eligibility Inspections of pump stations

RATED ITEM	A			M			U			N/A			EVALUATION	LOCATIONS, REMARKS, RECOMMENDATIONS
1. Pump Station Operating Log (A or U only)												A	Operation and maintenance log is present at the pump station and is being used and updated, and personnel have been trained in pump station operations. Names and last training date shown in the log book.	
												U	No operating log present, or refresher training for personnel has not been conducted.	
2. Pump Station Operations and Maintenance Manual (A or U only)												A	Operation and Maintenance Manual and/or posted operating instructions are present and adequately cover all pertinent pump station features.	
												U	Operation and Maintenance Manual missing or sponsor is unsure of location.	
3. Plant Building												A	The building is in good structural condition, with no major cracks in concrete or brick. The roof is not leaking, exhaust fans are operational, there are no exposed electrical components, and the working environment is safe.	
												M	There is significant cracking in the building structure, or the building is damaged in other ways such that it needs repair but does not threaten pumping operations.	
												U	The structural integrity or stability of the building is threatened, or there is other damage to the building such that pumping operations can not be performed as intended.	
4. Communications (A or U only)												A	A telephone, cellular phone, two-way radio, or similar device is available to pump station operator and maintenance personnel.	
												U	A telephone, cellular phone, two-way radio, or similar device is not available to pump station operator and maintenance personnel.	
5. Safety (A or U only)												A	Exhaust fans, vents/louvers are working properly. Fuel storage / distribution meets state / local requirements. Fire extinguishers of sufficient quality, quantity, and type are on hand and are properly charged. Safety hardware (hand rails, grates for wells, etc) is installed. Required safety items used (hearing, eyes, etc).	
												U	Safety issues exist that could cause injury or loss of life.	
												A	Safety/ security fencing is in good condition and provides protection against falling or unauthorized access. Gates open and close freely, locks are in place, and there is little corrosion on metal parts.	
6. Safety Fencing RODI												M	Safety/ security fencing or gates are damaged or corroded but appear to be maintainable. Locks may be missing or damaged.	
												U	Safety/ security fencing and gates are damaged or corroded to the point that replacement is required, or potentially dangerous project features are not secured.	
												N/A	There are no features in or around the pump stations that require safety fencing.	

Key: A = Acceptable, M = Minimally Acceptable, Maintenance is required, U = Unacceptable, N/A = Not Applicable, RODI = Requires Operation During Inspection

Pump Stations (continued)
 For use during all Initial and Continuing Eligibility Inspections of pump stations

RATED ITEM	A			M			U			N/A			EVALUATION	LOCATIONS, REMARKS, RECOMMENDATIONS
7. Cranes RODI													A Crane operational, and have been inspected and load tested in accordance with OSHA requirements.	
													M Crane has not been inspected or operationally tested with the past year, or there are visible signs of corrosion, oil leakage, etc, requiring maintenance.	
													U Crane not operational, or tagged out of service.	
8. Pumps													N/A There are no cranes.	
													A All pumps are properly maintained and lubricated. Systems are periodically tested, and there is no evidence of cavitation, vibrations, or unusual sounds.	
													M Minor deficiencies exist which need to be closely monitored or repaired, such as the presence of minor vibrations or the corrosion of the pump shaft housing. However, the pumps are operational and are expected to perform through the next period of usage.	
9. Power (A or U only)													U One or more of the pumps are not operational, or the pump capacity has degraded to the point where project performance is in question.	
													A The power source is adequate, safe, and reliable. Backup generators are on hand or there is a reliable backup power plan in place. Backup units are properly sized, operational, periodically exercised, and properly maintained.	
													U Power source not considered safe or reliable to sustain operations during flood conditions.	
10. Insulation Megger Testing													A Results of megger tests show that the insulation meets manufacturer's or industry standards. Tested within the last 2 years.	
													M Results of megger test show that insulation resistance is lower than manufacturer's or industry standard, but can be corrected with proper application of heat, or megger testing not conducted with the last 2 years.	
													U Megger tests not conducted within past three years or indicate that insulation resistance is low enough that the equipment will not be able to meet design standards of operation, or evidence of arcing or shorting is detected visually.	
11. Motors, Engines, Fans and Gear Reducers													A All items are operational. Preventative maintenance and lubrication is being performed and the system is periodically subjected to performance testing. Instrumentation, alarms, and auto shutdowns are operational.	
													M Systems have minor deficiencies, but are operational and will function adequately through the next flood.	
													U One or more of the primary motors or systems is not operational.	

Key: A = Acceptable, M = Minimally Acceptable, Maintenance is required, U = Unacceptable, N/A = Not Applicable, RODI = Requires Operation During Inspection

Pump Stations (continued)
 For use during all Initial and Continuing Eligibility Inspections of pump stations

Page 3 of 4

RATED ITEM	A			M			U			N/A			EVALUATION	LOCATIONS, REMARKS, RECOMMENDATIONS
12. Pump Control Systems													A Operational and maintained free of damage, corrosion, or other debris.	
													M Operational with minor discrepancies. Will function adequately during the next flood event.	
													U Pump controls not operational.	
13. Sumps / Wet well													A Clear of excessive debris, sediment, or other obstructions. Procedures are in place to remove debris accumulation during operation.	
													M Debris, sediment, or other obstructions are present and must be removed, but the sump/wet well will function as intended during the next flood. Procedures are in place to remove debris accumulation during operation.	
													U Large debris or excessive silt present which will hinder or damage pumps during operation, or no procedures have been established to remove debris accumulation during operation.	
14. Trash Rakes (Mechanical Operations) RODI													A Drive chain, bearings, gear reducers, and other components are in good operating condition and are being properly maintained.	
													M The trash rake is in need of maintenance, but is still operational.	
													U Trash rake not operational or deficiencies will inhibit operations during the next flood event.	
15. Trash Racks (non-mechanical)													N/A There are no mechanical trash rakes.	
													A Trash racks are fastened in place and properly maintained.	
													M Trash racks are in place but are unfastened or have bent bars that allow debris to enter into the pipe or pump station. Repair or replacement is required.	
16. Sluice / Slide Gates RODI													U Trash rack is missing or damaged to the extent that it is no longer functional and must be replaced.	
													N/A There are no non-mechanical trash rakes.	
													A Gates open and close freely with minor leakage. Sill is free of sediment and other obstructions. Gates and lifters have been maintained.	
													M Gates have been damaged or have deteriorated, and open and close with resistance or binding. Leakage quantity is controllable and is not a threat to project performance. Maintenance is required.	
													U Gates do not open or close. Gate, stem, lifter and/or guides may be damaged or corroded.	
													N/A There are no sluice/slide gates.	

Key: A = Acceptable, M = Minimally Acceptable, Maintenance is required, U = Unacceptable, N/A = Not Applicable, RODI = Requires Operation During Inspection

Pump Stations - Continued on Next Page

Pump Stations (continued)

For use during all Initial and Continuing Eligibility Inspections of pump stations

RATED ITEM	A			M			U			N/A			EVALUATION	LOCATIONS, REMARKS, RECOMMENDATIONS
17. Electric Gate Operators for Sluice / Slide Gates (Intake/ Discharge) RODI												A. All electric gate operators are in good working condition and are adequately powered, and are capable of opening and closing the gate properly. Preventative maintenance is being performed and the system is tested periodically.		
												M. All electric gate operators are operational with minor deficiencies, but should perform through the next period of usage.		
												U. The electric gate operators are not operational, or the power source is not considered reliable to sustain operations during flood conditions.		
18. Manual Operators (Backups) for Sluice / Slide Gates RODI												N/A. There are no electric gate operators.		
												A. All manual gate operators are in good working condition and are capable of opening and closing the gate properly. Preventative maintenance is being performed and the system is tested periodically.		
												M. Manual gate operators are operational with minor deficiencies, but should perform through the next period of usage.		
19. Other Metallic Items (Equipment, Ladders, Platform Anchors, etc)												U. Manual gate operators are not operational.		
												N/A. If there are no sluice/slide gates, this item is N/A.		
												A. All metal parts are protected from corrosion damage, and show no rust, damage, or deterioration that would cause a safety concern.		
												M. Corrosion seen on metallic parts appear to be maintainable.		
												U. Metallic parts are severely corroded and require replacement to prevent failure, equipment damage, or safety issues.		
												N/A. There are no other significant metallic items associated with the pump stations.		

Key: A = Acceptable, M = Minimally Acceptable, Maintenance is required, U = Unacceptable, N/A = Not Applicable, RODI = Requires Operation During Inspection

Additional issues noted during the inspection:

Earthen (Excavated) Flood Control Channels
 For use during all Initial and Continuing Eligibility Inspections of excavated flood control channels

RATED ITEM	A			M			U			N/A			EVALUATION	LOCATIONS, REMARKS, RECOMMENDATIONS
1. Vegetation and Obstructions												A. There are minimal obstructions or vegetation blocking the FCW.		
												M. The channel is obstructed by minor log jams, snags, or vegetation. Less than 20% of the channel is obstructed.		
												U. Obstructions or vegetation growth have obstructed over 20% of the river or channel.		
2. Shoaling												A. No shoaling present.		
												M. Non-aquatic grasses present on shoal. No trees or brush is present on shoal, and channel flow is not impeded.		
3. Encroachments												U. Shoaling is well established, stabilized by trees, brush, or other vegetation. Shoals are diverting flow to channel bank causing bank erosion and undercutting.		
												A. No trash, debris, excavations, structures, or other obstructions present within the project easement area. Encroachments which do not diminish proper functioning of the project have been previously approved by the Corps.		
												M. Trash, debris, excavations, structures, or other obstructions present, or inappropriate activities that will not inhibit project operations and maintenance or emergency operations. Encroachments have not been approved by the Corps.		
												U. Trash, debris, excavation, structures, or other obstructions present, or inappropriate activities that will inhibit project operations and maintenance or emergency operations.		
												A. Existing riprap protection is properly maintained and is undamaged. Riprap clearly visible.		
4. Riprap Revetments & Banks												M. No riprap displacement or scouring activity that could undercut banks, erode embankments, or restrict desired flow. Unwanted vegetation must be cleared and sprayed with an appropriate herbicide.		
												U. Dense brush, trees, or grasses hide the rock protection, or meandering and/or scour activity is undercutting banks, eroding embankments, or impairing channel flows by causing turbulence or shoaling.		
												N/A. There is no riprap protecting the channel.		
5. Erosion												A. No head cutting or horizontal deviation observed.		
												M. Head cutting and horizontal deviation evident, but is less than 30 cm (1 foot) from the designed grade or cross section.		
												U. Apparent head cutting and horizontal deviation of more than 30 cm (1 foot) from the designed grade or cross section. Corrective actions required to stop or slow erosion.		

Key: A = Acceptable; M = Minimally Acceptable, Maintenance is required; U = Unacceptable; N/A = Not Applicable; RODI = Requires Operation During Inspection

Earthen (Excavated) Flood Control Channels (continued)

For use during all Initial and Continuing Eligibility Inspections of excavated flood control channels

RATED ITEM	A			M			U			N/A			EVALUATION	LOCATIONS/REMARKS/RECOMMENDATIONS
6. Concrete Surfaces													A Negligible spalling, scaling or cracking. If the concrete surface is weathered, rough to the touch, or holds moisture, it is still satisfactory but should be seal coated to prevent freeze/thaw damage.	
													M Spalling, scaling, and open cracking present, but the immediate integrity or performance of the structure is not threatened. Reinforcing steel may be exposed. Repairs/ sealing is necessary to prevent additional damage during periods of thawing and freezing.	
													U Surface deterioration or deep, controlled cracks present that result in an unreliable structure.	
7. Tilting, Sliding or Settlement of Concrete Structures													N/A There are no concrete structures associated with the flood control channel.	
													A There are no significant areas of tilting, sliding, or settlement that would endanger the integrity of the project.	
													M There are areas of tilting, sliding, or settlement (either active or inactive) that need to be repaired. The integrity of the structure is not in danger.	
8. Foundation of Concrete Structures													U There are areas of tilting, sliding, or settlement (either active or inactive) that threaten the structure's integrity and performance.	
													N/A There are no concrete structures associated with the flood control channel.	
													A No scouring / erosion, or undermining near the structure.	
9. Flap Gates/Flap Valves/ Pinch Valves RODI													M Scouring / erosion near the footing of the structure but not close enough to affect structure stability during the next flood.	
													U Scouring or undermining at the foundation that has affected structural integrity.	
													N/A There are no concrete structures associated with the flood control channel.	
													A Flap gates open and close easily with minimal leakage.	
													Gates show no corrosion damage and have been maintained.	
													M Gate will not fully open or close because of obstructions that can be easily removed, or has corrosion damage that requires maintenance.	
												U Gate is missing, has been damaged, or has deteriorated and needs repair.		
													N/A There are no flap gates.	

Key: A = Acceptable; M = Minimally Acceptable; Maintenance is required; U = Unacceptable; N/A = Not Applicable; RODI = Requires Operation During Inspection

Additional issues noted during the inspection:

Concrete Lined Flood Control Channels
 For use during all Initial and Continuing Eligibility Inspections of concrete lined flood control channels

RATED ITEM	A			M			U			N/A			EVALUATION	LOCATIONS, REMARKS, RECOMMENDATIONS
1. Vegetation and Obstructions												A	No obstructions, vegetation, debris, or sediment accumulation within the channel. Channel joints and weep holes are also free of grass and weeds.	
												M	Sediment and debris present, but not to the degree that it supports vegetation. Obstructions/ debris have not impaired the channel flow capacity. Sediment and debris removal recommended.	
												U	Sediment shoals are well established and support vegetation, or there are obstructions or accumulated debris that have impaired the channel flow capacity. Sediment and debris removal required to re-establish flow capacity.	
2. Shoaling												A	No shoaling present.	
												M	Non-aquatic grasses present on shoal. No trees or brush is present on shoal, and channel flow is not impeded.	
												U	Shoaling is well established, stabilized by saplings, brush, or other vegetation. Shoals are diverting flow to channel walls. Channel flow capacity is reduced and maintenance is required.	
3. Concrete Surfaces												A	Negligible spalling, scaling or cracking. If the concrete surface is weathered, rough to the touch, or holds moisture, it is still satisfactory but should be seal coated to prevent freeze/thaw damage.	
												M	Spalling, scaling, and open cracking present, but the immediate integrity or performance of the structure is not threatened. Reinforcing steel may be exposed. Repairs/ sealing is necessary to prevent additional damage during periods of thawing and freezing.	
												U	Surface deterioration or deep, controlled cracks present that result in an unreliable structure.	
4. Tilting, Sliding or Settlement of Concrete Structures												A	There are no significant areas of tilting, sliding, or settlement that would endanger the integrity of the project.	
												M	There are areas of tilting, sliding, or settlement (either active or inactive) that need to be repaired. The integrity of the structure is not in danger.	
												U	There are areas of tilting, sliding, or settlement (either active or inactive) that threaten the structure's integrity and performance.	
5. Foundation of Concrete Structures												A	No scouring / erosion, or undermining near the structure.	
												M	Scouring / erosion near the footing of the structure but not close enough to affect structure stability during the next flood.	
												U	Scouring or undermining at the foundation that has affected structural integrity.	

Key: A = Acceptable, M = Minimally Acceptable, Maintenance is required, U = Unacceptable, N/A = Not Applicable, RODI = Requires Operation During Inspection

Concrete Lined Channels - Continued on Next Page

Concrete Lined Flood Control Channels
 For use during all Initial and Continuing Eligibility Inspections of concrete lined flood control channels

RATED ITEM	A			M			U			N/A			EVALUATION	LOCATIONS/REMARKS/RECOMMENDATIONS
6. Monolith Joints													A. The monolith joint material is in good condition. M. The monolith joint material is deteriorating and needs to be repaired or replaced to prevent spalling and cracking during freeze/thaw cycles. U. The monolith joint material is severely deteriorated and the concrete has spalled and cracked, damaging the waterstop to the point where it will not provide the intended level of protection during a flood. N/A. There are no monolith joints.	
7. Flap Gates/Flap Valves/ Pinch Valves RODI													A. Flap gates open and close easily with minimal leakage. Gates show no corrosion damage and have been maintained. M. Gate will not fully open or close because of obstructions that can be easily removed, or has corrosion damage that requires maintenance. U. Gate is missing, has been damaged, or has deteriorated and needs repair. N/A. There are no flap gates.	

Key: A = Acceptable, M = Minimally Acceptable, Maintenance is required, U = Unacceptable, N/A = Not Applicable, RODI = Requires Operation During Inspection

Additional issues noted during the inspection:

Instructions for the Inspection Guide

GENERAL INSTRUCTIONS.

1. The sections of this report labeled "Basic Eligibility" and "FCW Engineering" only need to be completed during Initial Eligibility Inspections.
2. Determination of Minimum Elevation for Levees and Floodwalls (#1 under FCW Engineering): Depending on available data and local Corps policy, the minimum elevation required may be calculated using traditional methods, with the addition of 1 foot of freeboard in agricultural areas and 2 feet of freeboard in urban areas, or using annual exceedance probability, which numerically accounts for the natural variation and uncertainty when estimating discharge-probability and stage-discharge functions so that additional requirements for elevation are based on the level of risk in the data.
3. All other sections of this guide that correspond to project features in the Flood Control Work must be fully completed during every Continuing and Initial Eligibility Inspection.
4. RODI stands for "Requires Operation During Inspection". Items marked "RODI" will be rated based on the way they work during the inspection.
5. Additional areas for inspection will be incorporated by the inspector into this guide if the layout or physical characteristics of the project warrant this. Appropriate entries will be made in the REMARKS block.

RATINGS OF INDIVIDUAL ITEMS:

The following terms and definitions are used when determining the rating for each item and/or component in the flood control work.

A - Acceptable: The rated item is in satisfactory condition, with no deficiencies, and will function as designed and intended during the next flood event.

M - Minimally Acceptable: This rated item has minor deficiencies that need to be corrected. The minor deficiencies will not seriously impair the functioning of the item during the next flood event. The overall reliability of the project will be lowered because of the minor deficiency.

U - Unacceptable: The deficiencies are serious enough that the rated item will not adequately function during the next flood event, compromising the project's ability to provide reliable flood protection.

DETERMINATION OF OVERALL PROJECT CONDITION CODE:

The lowest single rating given for a rated item will determine the overall condition of the project:

1. If all items are rated as Acceptable, the overall project condition will be rated as Acceptable.
2. If one or more items are rated as Minimally Acceptable, the overall project condition will be rated Minimally Acceptable.
3. If one or more items is rated as Unacceptable, the overall project condition will be rated as Unacceptable.

PROJECT CONDITION AND ELIGIBILITY FOR PL84-99 ASSISTANCE:

1. Projects rated as Acceptable are considered "Active" and eligible for PL84-99 post flood or storm damage rehabilitation assistance from the U.S. Army Corps of Engineers.
2. Projects rated Minimally Acceptable are considered "Active" and eligible for PL84-99 rehabilitation assistance during the time that it takes to make needed corrections. This timeframe will be agreed upon between the project sponsor and Corps inspector at the time of the inspection (or shortly thereafter). If the project sponsor does not present the Corps with proof of completion of the repairs/maintenance by the end of this timeframe, then the project will be "Inactive" and will be ineligible for PL84-99 rehabilitation assistance.
3. Projects rated as Unacceptable are immediately put in an "Inactive" status and are not eligible for PL84-99 post flood or storm damage rehabilitation assistance from the Corps of Engineers. The project will remain in an inactive status until the project sponsor presents the Corps with proof that all of the required repairs/maintenance has been completed. (This includes any repairs/ maintenance required for project features rated minimally Acceptable, as well as those rated Unacceptable.)

REPORT DOCUMENTATION PAGE

Form Approved
OMB No. 0704-0188

Public reporting burden for this collection of information is estimated to average 1 hour per response, including the time for reviewing instructions, searching existing data sources, gathering and maintaining the data needed, and completing and reviewing this collection of information. Send comments regarding this burden estimate or any other aspect of this collection of information, including suggestions for reducing this burden to Department of Defense, Washington Headquarters Services, Directorate for Information Operations and Reports (0704-0188), 1215 Jefferson Davis Highway, Suite 1204, Arlington, VA 22202-4302. Respondents should be aware that notwithstanding any other provision of law, no person shall be subject to any penalty for failing to comply with a collection of information if it does not display a currently valid OMB control number. **PLEASE DO NOT RETURN YOUR FORM TO THE ABOVE ADDRESS.**

1. REPORT DATE (DD-MM-YYYY) July 2017	2. REPORT TYPE Final report	3. DATES COVERED (From - To) 12/2014 – 3/2017		
4. REPORT TITLE Remote Sensing and Monitoring of Earthen Flood-Control Structures		5a. CONTRACT NUMBER		
		5b. GRANT NUMBER		
		5c. PROGRAM ELEMENT NUMBER		
6. AUTHORS Joseph B. Dunbar, Gustavo Galan-Comas, Lucas A. Walshire, Ronald E. Wahl, Donald E. Yule, Maureen K. Corcoran, Amber L. Bufkin, and Jose L. Llopis		5d. PROJECT NUMBER		
		5e. TASK NUMBER		
		5f. WORK UNIT NUMBER J8D2HJ		
7. PERFORMING ORGANIZATION NAME(S) AND ADDRESS(ES) U.S. Army Engineer Research and Development Center Geotechnical and Structures Laboratory 3909 Halls Ferry Road Vicksburg, MS 39180-6199		8. PERFORMING ORGANIZATION REPORT NUMBER ERDC/GSL TR-17-21		
9. SPONSORING / MONITORING AGENCY NAME(S) AND ADDRESS(ES) Headquarters, U.S. Army Corps of Engineers Washington, DC 20314-1000		10. SPONSOR/MONITOR'S ACRONYM(S) HQUSACE		
		11. SPONSOR/MONITOR'S REPORT NUMBER(S)		
12. DISTRIBUTION / AVAILABILITY STATEMENT Approved for public release; distribution is unlimited.				
13. SUPPLEMENTARY NOTES				
14. ABSTRACT The purpose of this study was to identify and review technologies that are applicable in locating weaknesses and poor performance within flood-control structures from extreme loading events. The focus of this study was to assess current technologies and state-of-practice techniques involving remote sensing, testing, and real-time monitoring of earthen structures. Advancements in satellite and sensor technology combined with high-speed internet and telecommunication capabilities and smart decision-making software permits real-time monitoring of earthen flood-control structures such as dams and levees. Technologies evaluated included both active and passive sensing methods. These technologies included satellite, airborne, and ground-based sensor systems to identify surface and subsurface characteristics of the watershed, as well as point sensors typically embedded in hydraulic structures to monitor the health of the structure. Point sensors typically record water loading, soil pore pressures, soil movements, and other important properties to evaluate global stability of the water control structure. Geophysical-based methods are typically used in mapping, monitoring, and detection of subsurface stratigraphy, seepage, and any changes in subsurface conditions through time within flood-control structures and their foundations.				
15. SUBJECT TERMS Levee performance, Levees, Remote monitoring, Earthen structures, Earth dams, Flood-control structures, Flood control, Hydraulic structures, Remote sensing, Geophysical surveys				
16. SECURITY CLASSIFICATION OF:			17. LIMITATION OF ABSTRACT	18. NUMBER OF PAGES
a. REPORT UNCLASSIFIED	b. ABSTRACT UNCLASSIFIED	c. THIS PAGE UNCLASSIFIED	SAR	320
			19a. NAME OF RESPONSIBLE PERSON	
			19b. TELEPHONE NUMBER (include area code)	