



Greaseless Bushings for Hydropower Applications: Program, Testing, and Results

John A. Jones, Rick A. Palylyk, Paul Willis, and Robert A. Weber

The U.S. Army Corps of Engineers (USACE) has been assessing the potential environmental and economic benefits of replacing greased or oiled bushings with greaseless (self-lubricated) bushings at its hydropower and navigation facilities. Products of this type currently on the market, however, were not specifically developed for the high-load, low-speed oscillating operating conditions typical for power-generation machinery. In-place testing of these materials on real-world hydroelectric equipment would pose too much risk of failure for critical facilities, and require many years to obtain meaningful performance comparisons. No standard specifications or laboratory tests for such applications have yet been developed and widely accepted.

The U.S. Army Construction Engineering Research Laboratory (CERL) cooperated in a joint effort between the USACE Hydroelectric Design Center (HDC; Portland, Oregon) and Powertech Laboratories Inc. (Surrey, BC, Canada) to use Powertech's equipment and the combined hydroelectric expertise of HDC and Powertech Laboratories to develop standardized test procedures and a rating system for greaseless bushing materials intended for oscillating operation in high-load, low-speed conditions. An objective of this work was to evaluate a series of greaseless bushing materials using the new testing regimen.

This report documents the development of the testing regimen, discusses the bearing rating procedure, and summarizes the results of the materials testing program.

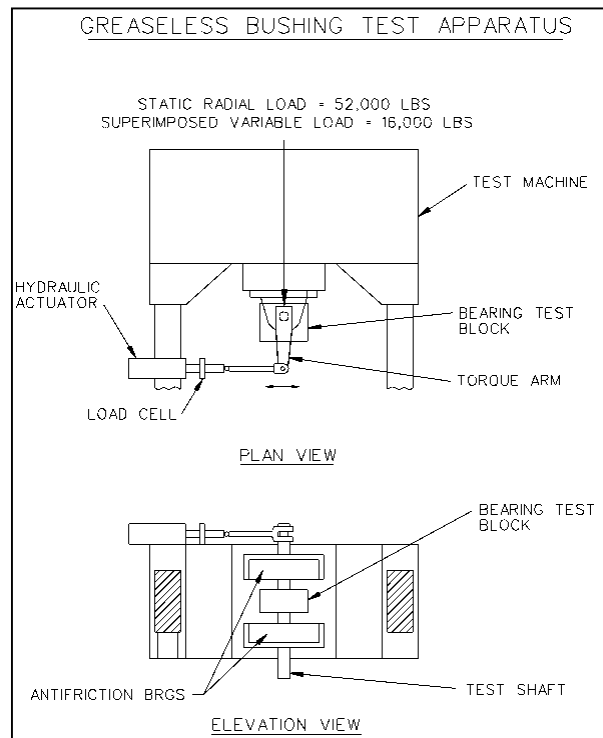

Foreword

This study was conducted for Headquarters, U.S. Army Corps of Engineers under Civil Works Investigations and Studies (CWIS) Work Unit 32820, "Self-Lubricating (Greaseless) Bushings for use at Corps Facilities"; 315 – Electrical/Mechanical Program. The technical monitor was Andy Wu (CECW-ET).

The work was performed at the Corps of Engineers Hydroelectric Design Center (HDC) for the Materials and Structures Branch (CF-M) of the Facilities Division (CF), Construction Engineering Research Laboratory (CERL). John A. Jones was the Principal Investigator at HDC, and Paul Willis was the HDC Coordinator. Rick A. Palylyk, Powertech Laboratories Inc., is a consultant for HDC. Robert A. Weber was the Principal Investigator at CERL. Dr. Ilker Adiguzel is Chief, CF-M, and L. Michael Golish is Chief, CF. The technical editor was Gordon L. Cohen, Information Technology Laboratory.

The Director of CERL is Dr. Michael J. O'Connor.

Contents

Foreword	2
List of Figures	5
1 Introduction	7
Background	7
Objectives.....	8
Approach.....	8
Scope	9
Mode of Technology Transfer	9
Units of Weight and Measure.....	10
2 Development of the Standardized Tests	11
The Need for Standardized Bearing Performance Tests.....	11
Summary of User Survey.....	12
Summary of Test Development and Procedures.....	13
3 Summary of Materials Testing Program Using the New Test Procedures	15
Friction and Wear Testing.....	15
<i>Friction Coefficients</i>	15
<i>Standard Wear Results</i>	15
<i>Extended Wear Results</i>	15
<i>Correlation of Test Results to Service Life</i>	16
Swell Test Results	16
Rating System and Rating Charts	16
Discussion and Interpretation of Test Results.....	16
<i>Shaft Material</i>	17
<i>Shaft Hardness</i>	17
<i>Shaft Finish</i>	17
<i>Bearing Length-to-Diameter (L/D) Ratio</i>	17
<i>Bearing Operating Clearance</i>	18
<i>Bearing Material Relaxation of Press Fits</i>	19
<i>Bearing Design Pressure</i>	19
<i>Bearing Susceptibility to Damage from Edge Pressure</i>	20
<i>Bearing Creep or Extrusion Under Load</i>	20
<i>Separation of Creep from Wear</i>	21

<i>Bearing and Bearing Bond Resistance to Vibration</i>	21
<i>Use of Seals to Exclude All Foreign Matter</i>	21
<i>"Stiction" of the Bearing System</i>	21
<i>Abrasion Resistance and the Use of Seals</i>	22
4 Conclusions and Recommendations	23
Conclusions	23
<i>Applicability of Test Results</i>	23
<i>General Comments — Load Capacity Versus Bearing Thickness</i>	23
Recommendation: Need for Long-Term Material Creep Tests	24
Appendix A: Description of Friction and Wear Testing Program	25
Appendix B: Friction and Wear Test Results	34
Appendix C: Correlation of Wear Test Results to Service Life	52
Appendix D: Description of Swell Testing Program	55
Appendix E: Swell Test Results	61
Appendix F: The Bearing Rating System	103
Appendix G: Rating the Bearings	111
Distribution	121
Report Documentation Page	122

List of Figures

Figures

A1	Greaseless bushing test apparatus	30
A2	Apparatus detail showing water-cooled test sleeve.....	31
A3	Detail showing tapered test sleeve	32
B1	Greaseless bushing tests — benchmark bronze.....	40
B2	Greaseless bushing tests — Delrin AF100 and Devatex I	41
B3	Greaseless bushing tests — Lubron TF and Fiberglide	42
B4	Greaseless bushing tests — Orkot TXM-M and Karon V	43
B5	Greaseless bushing tests — Karon V and F@8,000 psi	44
B6	Greaseless bushing tests — Tenmat T12 and T814.....	45
B7	Greaseless bushing tests — Thordon TRAXL SXL and HPSXL	46
B8	Greaseless bushing tests — Thordon TRAXL SXL and Deva Metal.....	47
B9	Greaseless bushing tests — Devatex II.....	48
E1	Diametrical allowance for swell in water	64
E2	Diametrical allowance for swell in oil	65
E3	Average change in water swell length vs time using Devatex	66
E4	Average change in water swell thickness vs time using Devatex	67
E5	Average change in oil swell length vs time using Devatex.....	68
E6	Average change in oil swell thickness vs time using Devatex	69
E7	Average change in water swell length vs time using a Devatex composite backing.....	70
E8	Average change in water swell thickness vs time using a Devatex composite backing.....	71
E9	Average change in oil swell length vs time using a Devatex composite backing.....	72
E10	Average change in oil swell thickness vs time using a Devatex composite backing.....	73
E11	Average change in water swell length vs time using Karon V	74
E12	Average change in water swell thickness vs time using Karon V	75
E13	Average change in oil swell length vs time using Karon V	76
E14	Average change in oil swell thickness vs time using Karon V	77
E15	Average change in water swell length vs time using a Kamatics composite backing.....	78

E16	Average change in water swell thickness vs time using a Kamatics composite backing	79
E17	Average change in oil swell length vs time using a Kamatics composite backing.....	80
E18	Average change in oil swell thickness vs time using a Kamatics composite backing.....	81
E19	Average change in water swell length vs time using Orkot TXM-M.....	82
E20	Average change in water swell thickness vs time using Orkot TXM-M.....	83
E21	Average change in oil swell length vs time using Orkot TXM-M.....	84
E22	Average change in oil swell thickness vs time using Orkot TXM-M.....	85
E23	Average change in water swell length vs time using Tenmat T814.....	86
E24	Average change in water swell thickness vs time using Tenmat T814	87
E25	Average change in oil swell length vs time using Tenmat T814.....	88
E26	Average change in oil swell thickness vs time using Tenmat T814.....	89
E27	Average change in water swell length vs time using Thordon TRAXL HPSXL.....	90
E28	Average change in water swell thickness vs time using Thordon TRAXL HPSXL	91
E29	Average change in oil swell length vs time using Thordon TRAXL HPSXL.....	92
E30	Average change in oil swell thickness vs time using Thordon TRAXL HPSXL.....	93
E31	Average change in water swell length vs time using Delrin AF100	94
E32	Average change in water swell thickness vs time using Delrin AF100.....	95
E33	Average change in oil swell length vs time using Delrin AF100	96
E34	Average change in oil swell thickness vs time using Delrin AF100	97
E35	Change in material length per unit length in water	98
E36	Change in material thickness per unit thickness in water.....	99
E37	Change in material length per unit length in oil	100
E38	Change in material thickness per unit thickness in oil.....	101
G1	COE greaseless bushing tests, Delrin AF100 and Devatex I.....	114
G2	COE greaseless bushing tests, Tenmat T12 and T814.	115
G3	Greaseless bushing rating for use as upper stem bushings (dry).	116
G4	Greaseless bushing rating for use as lower stem bushings (wet).	116
G5	Greaseless bushing rating for use as wicket gate linkages (dry).	117
G6	Greaseless bushing rating for use as operating ring bearings (dry).	117
G7	Greaseless bushing rating for use as intermediate stem bushings (wet).....	118
G8	Greaseless bushing rating for use as turbine hub linkages (dry).	118
G9	Greaseless bushing rating for use as blade trunnion bushings (dry).	119
G10	Greaseless bushing rating for use as turbine hub linkages (wet).....	119
G11	Greaseless bushing rating for use as blade trunnion bushings (wet).....	120

1 Introduction

Background

The U.S. Army Corps of Engineers (USACE) has traditionally used grease-lubricated bearings and bushings* between moving parts on Civil Works machinery. The use of greased bronze bushings in hydropower applications has a long history of success worldwide, many installations having been in continuous service for 30 to 50 years without replacement. The greases used on bronze bushings pose operational and environmental problems. Special precautions are needed to handle and dispose of these greases, and the unavoidable leakage of small quantities into the waterways degrades the water environment.

Many types of self-lubricated or *greaseless* bushings have been developed in recent years, and they offer some obvious advantages over conventional bushings. Historically, the selection of greaseless bushings has been based on the manufacturer's published literature, without performing any in-house testing. Many bushing applications are submerged in water, usually with abrasive contaminants present, and most of these applications are not equipped with seals. The USACE has studied the potential benefits of replacing greased or oiled bushings with greaseless (self-lubricated) bushings at its hydropower and navigation facilities. The Corps is considering greaseless bushings for use in every application where it would be practicable and economical to use them, but making that determination has not been straightforward for several reasons.

A large variety of greaseless bushing materials are available, and anecdotal reports from the field suggest that there are significant differences in material performance as well as discrepancies between manufacturers' performance claims and in-service performance. No standard specifications or evaluation techniques have yet been developed and widely accepted for highly loaded bushings

* Most greased and oiled bearings used at Corps hydropower plants are in the form of bushings — removable sleeves or liners that protect a shaft from friction-related wear. In this report, the terms *bearing* and *bushing* are used interchangeably.

subjected to oscillating motion, such as those used on power generation machinery. Furthermore, in-place testing of new types of bushings on real-world Civil Works project machinery is risky because of the potential for failures that could take a critical facility out of operation. Therefore, standardized laboratory tests and evaluation methods for self-lubricated bushing materials would be highly useful to engineers and designers who are interested in reducing the use of greases and oils on exposed moving parts.

Powertech Laboratories Inc. (Surrey, BC), a wholly owned subsidiary of the Canadian utility company B.C. Hydro, performed some research and testing of greaseless bushing materials for applications identical to those being considered by the Corps. The U.S. Army Construction Engineering Research Laboratory (CERL) cooperated in a joint effort between the USACE Hydroelectric Design Center, (HDC; Portland, Oregon) and Powertech Laboratories Inc. to use Powertech's equipment and the combined hydroelectric expertise of HDC and Powertech Laboratories to develop standardized test procedures and a rating system for greaseless bushing materials intended for oscillating operation in high-load, low-speed conditions.

Objectives

The objectives of this work were to (1) develop laboratory testing, evaluation, and rating techniques for greaseless bushing systems that will yield accurate predictions of their long-term performance in Civil Works projects, and (2) use these new tests to collect performance data on various greaseless bushing materials, rate them, and publish the results for prospective end users and suppliers.

Approach

The specific bushing applications investigated were for oscillating motion, high-load operation at low speeds in machinery such as tainter gates, miter gates, turbine wicket gate operating machinery, and other grease-lubricated bushing systems both above and below water.

Before the testing and rating protocols were developed, a survey questionnaire was developed and distributed to the field. The purposes of the survey were to help focus the standards-development effort on user requirements and to benefit

from the collective experience of real-world users. The following issues were studied and addressed:

- commercial availability of self-lubricating bushing materials
- published properties and characteristics of these materials
- current greaseless bushing applications in hydropower projects
- specific service conditions under which these bushings have been used
- overall field performance of the bushing materials
- tests or studies conducted by the user before selection and installation
- tests performed by the bushing manufacturers on their own products.

The findings from the initial phase of the research were used in the definition and development of standardized tests and a rating system capable of reliably qualifying or disqualifying greaseless bushings for use in hydropower and navigation facilities. The testing and rating protocols were then demonstrated on a series of greaseless bushing materials, and consensus on the validity of tests was sought from the leading bushing manufacturers.

Scope

This testing program focused on machinery and service conditions that the Corps and the hydropower industry considers most immediately applicable to hydropower projects. In order of environmental benefits and labor reduction for maintenance and repair, the applications of interest were turbine wicket gate stem bushings, wicket gate operating rings and linkages, turbine blade operating linkages, and turbine blade trunnion bushings.

The tests developed in this research do not include any procedures for abrasion-resistance testing because no method that produced consistent, reproducible results could be found.

Mode of Technology Transfer

The testing technology, methods, and rating procedures developed in this work have been adopted into daily practice by HDC, and have been accepted by the U.S. Navy as the standards for testing bearings for Navy use. These have also been accepted by informal consensus of leading bushing manufacturers. The testing and rating methodology will be submitted to the American Society for Testing and Materials (ASTM) for incorporation into an ASTM standard test specification.

Units of Weight and Measure

U.S. standard units of measure are used throughout this report. A table of conversion factors for Standard International (SI) units is provided below.

SI conversion factors		
1 in.	=	2.54 cm
1 ft	=	0.305 m
1 yd	=	0.9144 m
1 sq in.	=	6.452 cm ²
1 sq ft	=	0.093 m ²
1 sq yd	=	0.836 m ²
1 cu in.	=	16.39 cm ³
1 cu ft	=	0.028 m ³
1 cu yd	=	0.764 m ³
1 gal	=	3.78 L
1 lb	=	0.453 kg
1 psi	=	6.89 kPa
°F	=	(°C x 1.8) + 32

2 Development of the Standardized Tests

The Need for Standardized Bearing Performance Tests

A goal of the Corps of Engineers is to reduce pollution caused by the leaking of grease and oil from Civil Works machinery into waterways. A related goal is to reduce the frequency and cost of maintaining bushings used in and around waterways. Based primarily on environmental considerations, use of greaseless bushings is at least being considered for most of the power generating equipment in the U.S. that will soon be due for rehabilitation.

Corps experience with greaseless bushings has been limited. None have been in service for any great length of time except for some used on spillway gate trunnions, and these move very infrequently. Most early Corps experience with greaseless bushings has been negative, but use of the technology in appropriate applications is desirable nevertheless. Corps experience has shown that most bearings using lubricant plugs perform poorly in small-movement applications — and this is almost the only kind of motion that occurs in the targeted hydropower applications.

A standardized testing program for greaseless bushings would allow engineers to make more technically informed decisions when specifying such materials, but no such tests have been available. The application of any bearing material requires accurate knowledge of the physical, chemical, absorptive, frictional, and wear characteristics of that material. In particular, it is essential to engineer bushings for the *specific service conditions* of the individual application. To accurately compare the performance of different bearing materials, all bearings must be tested under exactly the same conditions, and those conditions should, as nearly as practicable, replicate in-service conditions.

No industry-accepted standardized tests have been available to rate greaseless bushings and no reliable knowledge base related to selection and application of these materials has existed. Preliminary independent laboratory testing (Ref. 1) shows that some of the available greaseless bushing systems have higher coefficients of friction and/or higher wear rates than the manufacturers' published values. These preliminary tests also indicate that the service life of these bushings would be shorter than that of greased bushings in many applications. These

findings indicate that the manufacturers' literature may not be reliable enough for engineering Corps hydropower applications. The discrepancies found in this preliminary testing may have resulted from the use of different test methods by different manufacturers.

Summary of User Survey

As noted in Chapter 1 under "Approach," a survey was developed to address key areas of concern related to the use of greaseless bushing materials:

- commercial availability of self-lubricating bushing materials
- published properties and characteristics of the available materials
- current greaseless bushing applications in hydropower projects
- specific service conditions in such applications
- overall field performance
- research by the user before selection and installation of greaseless bushings
- tests performed by the bushing manufacturers on their own products.

Questionnaires were developed asking what types of greaseless bushing materials were being used, where they were being used, and how well they had performed. The survey was distributed to Corps of Engineers and private-sector hydropower and navigation projects in the United States, Canada, and overseas.

Survey responses indicated that greaseless bushings are used with some frequency in Europe and other parts of the world, but so far they have been little used in the United States. Where greaseless bushings have been installed to replace greased bronze bushings in U.S. and Canadian hydropower projects, the results have been mixed. Most of the U.S. responses — principally from Corps of Engineers projects — indicate that up to the time of the survey, greaseless bushings had not performed as well as the conventional bushings they replaced. Some greaseless bushings have shown excessive wear for the time they have been in service, some have seized to the respective shafts. Seizure has sometimes been attributed to corrosion of the shaft and sometimes to swelling of the bearing material due to water absorption. Similar initial problems have been reported by Canadian users.

Several of the greaseless bushing systems exhibit high stick-slip characteristics, causing noise and mechanical chatter during operation. This problem was found in tainter gate trunnion bushings, for example. Some U.S. installations have in fact retrofitted grease-delivery systems on problem greaseless bushings in an attempt to eliminate the noise.

Responses received from outside North America were generally positive. Many hydropower installations outside North America use greaseless bushings extensively. Many of the greaseless bushings were installed as original equipment; others were retrofits.

The principal types of greaseless bushings currently used overseas are Teflon®-containing types such as Fiberglide and sintered bronze alloys such as Deva Metal bearings, which contain graphite or other lubricants dispersed throughout the metal matrix. Less commonly used are bronze alloy bearings with lubricant plugs, and plastic or elastomer bearings. In many applications reported by overseas users, a bushing design life of 15 to 25 years appears to be accepted practice.

Some bushing manufacturers surveyed have in-house testing facilities for their products. Others rely on outside testing laboratories to develop their product performance data and information.

Few of the bushing users (projects and equipment manufacturers) have performed any testing of the bushing systems they use, relying instead on the bushing manufacturer's published information. Several U.S. and Canadian government agencies have, or have initiated, bushing testing programs, and several of the bushing and turbine manufacturers worldwide have done likewise.

Summary of Test Development and Procedures

Details of test development, test procedures, and results may be found in the appendices of this report.

Standardized testing procedures for self-lubricating bushing materials were developed for the following parameters:

- coefficients of friction, both wet and dry
- wear rates, both wet and dry
- swell in water and oil.

This program employed testing equipment developed at Powertech Laboratories Inc., as previously indicated. A monitoring system that correlates turbine component movements in the field to time on the test stand has also been developed and is in use. Long-term creep test procedures have been developed, but have not yet been implemented.

Before the main performance testing cycle a preliminary series of tests (including chemical testing) is run as required to identify the material being tested, the structure of the bushing, and any lubricants it may contain.

The test apparatus consists of a water-cooled stainless steel sleeve with an inside diameter of 5 in. The major portion of the test procedure consists of statically loading the test bushing to 3300 psi, superimposing a plus-and-minus load of 1000 psi (giving a load range of 2300 psi through 4300 psi), and oscillating the loaded sleeve through plus and minus 1 degree at 2 cycles per second. This produces a rotation of 8 degrees per second. In addition, every 15 minutes the test sleeve is rotated through plus and minus 15 degrees, producing 60 degrees of rotation in 10 seconds. All loads, shaft displacement relative to the bushing, and temperatures of the cooling water and bushing are constantly monitored and automatically recorded on a chart recorder. The entire test is computer-controlled from start to finish. The nominal time required to run the test sequence is 144 hours. The first 24 hours involve minimal rotations while creep and set measurements are being made. The following 120 hours employ all of the cycled loading described above.

3 Summary of Materials Testing Program Using the New Test Procedures

Friction and Wear Testing

A detailed description of the friction and wear testing program may be found in Appendix A and the test results may be found in Appendix B. The bar charts in Appendix B show the coefficients of friction and wear rates for most of the materials that have been tested under the present procedure, including benchmark testing of standard bronze bushings using oil, grease, and water as lubricants.

Friction Coefficients

The friction coefficients shown on the bar charts for the various materials are the average of the peak values measured during the 80th through 120th hours of the accelerated wear tests. Previous testing had shown that, for most materials, the coefficients of friction stabilized long before the 80th hour of testing.

Maximum coefficient of static friction will be somewhat higher than shown by the graphs if the mechanism is loaded and stationary for an extended period. It is possible that static coefficients may be as much as 30 percent higher than shown in the bar charts if the mechanism is left loaded and stationary for months.

Standard Wear Results

The wear rates shown are the slope of the least squares curve fit of the test data during the same 80 through 120 hour test period. As above, it was found that most materials had reached a steady wear rate before the 80th test hour. Wear rates are expressed in mils per 100 test hours in order to estimate bearing life.

Extended Wear Results

The standard test time is 144 hours. The six materials that performed best in the standard tests were then subjected to extended testing for an additional 156

hours (300 hours total). In general, both coefficients of friction and wear rates *decreased* during the extended testing.

Correlation of Test Results to Service Life

As described in Appendix C, generating units at four Corps power plants (six turbines total) were instrumented to determine actual number and magnitude of blade and gate motions per year. Various difficulties prevented full execution of this plan. However, some reliable movement data were collected. When coupled with the applicable bearing diameter information, a correlation could be drawn between test stand hours and service life. Data from instrumented units indicates that the prescribed test stand time represents approximately 13 years of actual service in an operating unit. As a point of interest, 100 hours on the test stand amounts to almost 4 mi of bearing travel.

Swell Test Results

Swell tests were developed and implemented. Test description and results are found in Appendices D and E, respectively.

Rating System and Rating Charts

A rating system was necessary to make direct selection of bearings based on the test results. The rating system is included as Appendix F and the rating charts produced for the test series are included as Appendix G. The rating system and charts have been adopted by the USACE HDC for the selection of bearings.

It should be noted that long-term creep characteristics and ultimate swell of the materials in water and oil are not included in the rating system documented in Appendix F. Tests for long-term creep have been defined, but the program has not yet been initiated.

Discussion and Interpretation of Test Results

The following comments and conclusions are intended for application to turbine wicket gate stem bushings and to wicket gate and turbine blade operating mechanisms and any other bushings in that size range, operating under similar conditions, used by the Corps.

Shaft Material

For use underwater, and for most other applications, virtually all of the greaseless bushing manufacturers recommend the use of corrosion resistant shafts or sleeves in contact with the bushing. Most often mentioned is 17-4 PH, heat-treated, or medium- to high-strength steel, hard chrome plated. Heat-treated 17-4 PH or equal is recommended.

Shaft Hardness

Shaft hardness recommended by the bushing manufacturers varies widely, ranging from approximately R_c 16 (BHN 220) through R_c 60, which is beyond the BHN scale. In general, for higher loads and higher speeds, harder material is recommended. A better surface finish is recommended for the harder materials. Since available information indicates that all of the bushings can be operated satisfactorily against the harder shafts, it is recommended that the shaft (or sleeve) have hardness of R_c 28-32 (BHN 271-301).

Shaft Finish

Shaft finish recommended by the bushing manufacturers also varies widely, varying from R_a 0.1 micrometers (4 microinches) to R_a 6.35 micrometers (250 microinches). The finer finishes being recommended for the plastic, elastomer, or TFE containing bearings, and the coarser finishes being recommended for some of the bronze bearings using plug-type lubricant. A surface finish of R_a 0.4 micrometers (16 microinches) or better is recommended for all applications except the bronze bearings using plug-type lubricant. This surface finish falls within the recommended range for most of the available greaseless bushings.

Bearing Length-to-Diameter (L/D) Ratio

Thick-Walled Bushings

For thick-walled bushings the commonly recommended L/D ratio is from 1.0 to 2.0, with 1.25 often stated as preferred.

Thin-Walled Bushings

For thin-walled bushings the commonly recommended L/D ratio is from 0.35 to 1.0. Larger diameter bushings normally have lower L/D ratios, one manufacturer recommending L/D of 0.75 to 0.8 for bushing diameters up to 10 in., and

L/D of 0.35 to 0.40 for diameters larger than 10 in. The manufacturer should be consulted before finalizing a design.

Bearing Operating Clearance

Oscillatory Motion

For oscillatory motion, in other than hydropower applications, manufacturer-recommended operating clearance for most thin-walled bushings, ranges from a slight interference fit to a clearance of 0.001 in./in. of shaft diameter, depending on the bushing composition and diameter. Smaller diameter bushings have relatively larger operating clearance. Thick-walled bushings generally have recommended clearances of 0.001 in./in. to 0.002 in./in. of shaft diameter, with 0.0015 in./in. frequently recommended. Because of the relatively slow and infrequent motions of linkages and wicket gate shafts, and because of the large thermal masses involved, such large clearances on shafts or pins larger than 5 in. in diameter are not justified.

Swell

Because of swell due to absorption of water or other fluids, some bushing materials may require greater operating clearance. Some of the solid-lube bearings, and some of the elastomers, have manufacturer-recommended clearances of 0.003 in./in. to 0.005 in./in. of shaft diameter for continuous rotation in water. Because of the results of the swell tests, it is believed that such large clearances are not justified.

Bore Closure Due to Swell of Bearing from Fluids

Bearings consisting of various plastics, elastomers, filled resins, etc., and those bearing materials bonded to a metal substrate, absorb water or other liquids to varying degrees and swell in service. This swelling decreases the operating clearance designed into the bearing and has in several instances caused bearing failure by binding the mechanism. Moisture absorption in particular, for hydropower applications, must be addressed when a bushing of this type is selected. The results of the swell tests for several of the materials in water and oil can be found in Appendix E.

Bore Closure Due to Thermal Swell of Bearing

Thermal changes are usually not a problem in hydropower applications due to the relatively slow and infrequent motion and the fact that most of the

applications are submerged in water and/or imbedded in a large heat sink. Heat may be a problem in wear-testing some materials, however, since all of the non-metallic bearing materials conduct heat poorly. The high load, in combination with the high rate of oscillation present in the accelerated wear tests, may cause localized overheating of the bushing surface. Forced liquid cooling of the test sleeve may be required, and it has been provided in the test equipment to better represent bearing service conditions.

Recommended Installed Clearance

It is recommended that a 0.005 in. to 0.006 in. diametrical clearance be used for the bearings that have been tested.

Bearing Material Relaxation of Press Fits

Reports of some nonmetallic press-fitted bushings loosening, after being in service for only 2 to 3 years, indicates the need for some testing to be done in this area. The major questions are:

- Do the bushings relax spontaneously in the submerged environment? That is, do the bearing materials *soften* in water?
- Does the relaxation occur from deformation over time from a constantly applied load (creep)?
- Does the repetition of load application cause the relaxation?
- What part does vibration play?

Addressing these questions was outside the scope of the current work unit.

Bearing Design Pressure

Information received to date shows that typical design pressure for turbine bushings is in the range of 2500 psi to 3000 psi. Many of the available greaseless bushing materials have rated capacity equal to or greater than the above, some have rated capacity of ten or more times that. Close review of the published literature indicates 3000 psi to be near the practical limit for turbine design.

In-service wear track areas indicate that, in some turbine hubs, actual bearing pressures may be nearer 8000 psi. For equipment where misalignment or large operating clearance is likely to exist, such as blade trunnion bushings, it is recommended that bushing material be selected that has been tested for three times the equipment design load, using a well-fitted bearing. That is, if the design load of a bushing is 3000 psi, based on projected area, that the selected material be

tested and rated for operation at 9000 psi, based on projected area. This test is to help assure that localized crushing or other failure of the bushing, or bond, does not occur during the "bedding in" of the shaft that occurs during the development of sufficient contact area to support the load. This test is similar to, but less severe than the test for damage from edge pressure listed below.

Bearing Susceptibility to Damage from Edge Pressure

Equipment that is misaligned because of machining errors, faulty assembly, or because of deflection or large bearing clearances, can cause edge loading of bushings that may be several times the design load. Bushings that fracture under such loading, or bushing bond to substrate that fails, may lead to complete failure of the bushing. The standardized tests used here included testing for susceptibility to such damage; the test sleeve was machined with a small taper toward the middle from each end, beginning just beyond each end of the test bushing. This provides a balanced load on the bushing (no net moment) while simulating a misaligned shaft. Two overloaded ends from each tested bushing thus are available for examination. A taper on the test sleeve of 0.004 in./in. of bearing length appears to provide a realistic simulation of a misaligned shaft and provides the required edge loading. This test method is utilized with the standardized bushing load.

Bearing Creep or Extrusion Under Load

Some bushings have extruded while under test, and some have extruded while in service. Extrusion while under test may be partially the result of heat buildup at the bushing-to-shaft interface. Forced cooling of the replaceable sleeve is included in the standard test to eliminate that variable.

Creep that would otherwise be exhibited may be restrained by most current short-term creep tests due to the "clamping" effect caused by both surfaces being stationary. Periodic movement of the "shaft" surface during the creep test should relieve any clamping effect.

In some cases the units have been fully watered up, with the wicket gates closed, for months at a time. Because of this, it is essential that the bushing testing program include long-term exposure to maximum design load to test for creep or extrusion.

Separation of Creep from Wear

Initial accelerated wear tests were recording the sum of initial set, creep, and wear as total wear. The accelerated wear test setup has been modified, and procedures to separate initial set and creep from indicated wear were introduced. The method is to instrument and statically load the bearing exactly as for a wear test, and hold that load for 24 hours. The shaft is rotated through 5 degrees periodically during the test. For the first 4 hours, the rotation occurs every 5 minutes. For the remaining 20 hours, the rotation occurs every 10 minutes. The testing indicates that most, but not all, initial set and creep will have occurred within the 24 hour test period if the bearing is not loaded beyond its service capability.

This procedure increases by at least 1 day the time required to do complete testing of a bushing sample. However, it is believed that the results more closely represent the in-service wear rate that the bushing will exhibit. The wear tests are started immediately after the recording of creep is completed, and *recorded wear* will be *only wear*.

Bearing and Bearing Bond Resistance to Vibration

Some field projects, and one bushing manufacturer, have reported that under vibration there have been some bonding or bearing deterioration that rendered the bushing unserviceable. Testing for resistance to vibration is included in the Standardized Test procedure. Decisions had to be made regarding frequency and magnitude of vibration to be used, and whether it should be superimposed on the steady load during wear tests or performed as a separate test. It was decided that the vibratory load should be superimposed, and momentarily stopped during the periods when friction loads and shaft motion are being recorded.

Use of Seals to Exclude All Foreign Matter

Several bushing manufacturers do not state a need for seals to exclude water or other foreign matter from their bushings; others state that seals are required. The use of seals is recommended for all installations where water or other contaminants may be present.

“Stiction” of the Bearing System

Stick-slip, or “stiction,” is caused by the difference between static and dynamic coefficients of friction when a system is moved from rest. If these coefficients are noticeably different there will be stick-slip, causing vibration, noise, and possibly

damage to the equipment. The more nearly equal the coefficients are, the smoother the system will operate, even if actual friction is high. An analysis of the stick-slip phenomenon has been formulated based on the change in strain energy of the system between the statically loaded and dynamically loaded states, and it is used in the rating system. Of the several greaseless bushing materials that by test may prove satisfactory for a given application, selection of the one(s) having the least change in strain energy is recommended.

Abrasion Resistance and the Use of Seals

The testing program does not include any testing for abrasion resistance because no testing method has been found that yields consistent, reproducible results. Testing results show there are several greaseless bushing materials that outperform greased bronze by a factor of 2 to 5, when kept clean. In the absence of specific test information, and with the knowledge that a greased bronze bushing is able to partially exclude and purge dirt through frequent greasing, the use of seals is strongly recommended on every greaseless bushing used in the water.

4 Conclusions and Recommendations

Conclusions

Applicability of Test Results

The intention at HDC is to begin using the materials that have tested well to the widest extent possible. This includes fully greaseless/oilless hubs for turbines, as soon as the right “guinea pig” project is selected. Headquarters USACE has accepted the *concept* of equipping turbine hubs entirely with greaseless bushings, but HDC has not actually installed any yet. There is strong resistance at the projects to being the first to use greaseless bushings. This reluctance is because everyone knows that the *bronze* bushings work, and there have been problems with specific greaseless bushings they have tried. HDC test results show that many of the greaseless bushings will outperform bronze bushings by at least 2:1.

Note that, for most uses, several materials rate highly. Price then becomes a factor, and prices differ substantially. This report deliberately did not include either price or level of engineering support in rating the bushings because those items are variable and under the control of the individual companies, while bushing performance is not.

General Comments — Load Capacity Versus Bearing Thickness

With the exception of Thordon SXL and HPSXL, bushing load capacity seems little affected by bushing surface thickness within the range that these bushings are normally supplied. Thordon has found through its tests that its materials perform better when they are thinner — on the order of 0.030 in. thick — rather than the greater thickness they would normally provide.

The bushing surface material thickness as supplied by most manufacturers ranges from about 0.020 in. to 0.060 in., with 0.040 in. being about average. Fiberglide bushings are approximately 0.020 in. *total* thickness, Karon V, Devatex, and Lubron have standard surface thicknesses of about 0.040 in., and Tenmat and Orkot are the same material all the way through.

The reason for the award/subtraction of points for bearing thickness is primarily placatory. Project people and *some* of the bushing manufacturers strongly feel that thicker is better, equaling longer service life. The small deduction applied to Fiberglide type bushings and the small addition applied to the Tenmat (full thickness) type seem to be in general “satisfactory” to our maintenance staffs and to the bushing manufacturers. “Thicker is better” would make sense if the wear rates for all materials were equal. But, in fact, the wear rate of most of these materials is so low that a service life of 30 to 50 years is expected from even the thinnest of the bushings tested, if dirt is kept out of them.

Recommendation: Need for Long-Term Material Creep Tests

Because loads on the bearings for wicket gates or turbines rarely go to zero, any material that has a significant creep rate at the load it is subjected to will eventually cause alignment problems. A long-term creep testing program is needed to determine that property of the greaseless (self-lubricating) bearings intended for use in hydropower applications.

Such a creep test program has been outlined between the USACE HDC and Powertech Laboratories. The program is predicated on the assumption that it will be largely paid for by the bearing manufacturers, who have the most to gain (or lose) as a result of such testing.

Appendix A: Description of Friction and Wear Testing Program

Objectives of the Program

The objectives of this program were to:

1. Develop a reliable database for the informed selection of greaseless (self-lubricating) bushings for use in hydropower and navigation applications. Data will include, as a minimum: coefficients of static and dynamic friction under both wet (with water) and dry conditions, bushing initial set and creep, wear rate, bearing and bearing bond resistance to vibration, and resistance to edge damage.
2. Better define appropriate standard test procedures and parameters that will assure the development of that database.

Testing Apparatus and Procedure

Apparatus

The test setup shall consist of a shaft supported by two anti-friction, self-aligning, double roller bearings capable of sustaining the test radial load of 52,000 lb plus the superimposed load of 15,760 lb. The block containing the self-lubricating bushing under test shall be mounted between the two support bearings and rigidly prevented from rotating. The radial load shall be applied using a hydraulic cylinder. A hydraulic cylinder and load cell shall be attached to a radius arm on the shaft in order to provide for the shaft oscillation. An additional hydraulic cylinder, with appropriate controls, shall be attached to the test block to provide the superimposed variable load. Water cooling shall be provided for the test sleeves. Test bushings shall be fitted to the test block by means of appropriate adapter sleeves as required. The adapter sleeves shall provide the proper press-fit, or other, as designated by the bushing manufacturer.

Computer Program

The testing machine computer shall be programmed to maintain a constant radial load via the main hydraulic cylinder, generate the small and large oscillations, and control the superimposed variable load. The test cycle shall consist of the minor oscillations being continuous except for a major oscillation which will occur every 15 minutes. Two seconds before the end of the 15 minute minor oscillation cycle, the computer shall stop the application of the variable load and activate a strip chart recorder to record the conditions. The recorder shall revert to standby 2 seconds after the major swing is completed. Four minor oscillations, the major oscillation, and four more minor oscillations shall be recorded as an individual event. Midway through each 15 minute cycle, the chart recorder shall be activated for 5 seconds to record the effect of the superimposed variable load.

Description of the Tests

Types of Tests To Be Performed

1. materials composition
2. initial set and creep (both wet and dry)
3. friction and accelerated wear (both wet and dry)
4. edge damage.

Materials Composition

These will include all tests necessary to define the chemical composition of the basic bushing matrix and any lubricants contained therein or thereon.

Mechanical Tests

Standards

For all tests, bushing size, applied static load, type of oscillatory motion, number of test cycles, type and magnitude of superimposed vibratory load, and working fluid present will be as stated below. Bushing test sleeve size, material, hardness, and surface finish will also be identical. The bushing test sleeves will be water-cooled to maintain the bushing/sleeve interface temperature below 35 °C. Bearing temperature, inlet and outlet cooling water temperatures, and cooling water flow rate may be recorded by any appropriate means. Intervals for

temperature recording shall be short enough to define when steady-state conditions were reached, and also whether unusual heat buildup is occurring.

Initial Set and Creep Tests

Initial set, and wear, shall be monitored through a direct measurement of displacement between the test block and high pressure side of the shaft using an eddy current proximity probe.

These tests are to be performed on the same bushings and test sleeves as are used in the wear tests, and just prior to the beginning of the wear tests. Instrument and statically load the bushing exactly as for a wear test, and hold that load for 24 hours.

No superimposed vibratory load will be used during the set and creep tests. The shaft is to be rotated or oscillated through 5 degrees periodically during the 24 hour test. For the first 4 hours, the rotation/oscillation shall occur every 5 minutes. For the remaining 20 hours, the rotation shall occur every 10 minutes.

The wear tests can be started immediately after the recording of creep is completed. Record the indicated set and creep, then zero the measuring instrument prior to starting the wear tests. These tests must be performed for both the wet and dry conditions, and only using the straight test sleeves. It is not required to perform the set and creep tests using the tapered sleeves used for Edge Damage Testing.

3. FRICTION AND ACCELERATED WEAR:

a. STANDARD TESTS:

(1) SLEEVE: Straight sleeves will be used for standard tests.

(a) Outside diameter: 5.000/4.999 in., length to suit.

(b) Material: Heat treated S.S, 17-4 PH or equal.

(c) Hardness: R_c 28-32 (BHN 271-301).

(d) Surface finish: R_a 0.4 micrometers (16 microinches) minimum.

(e) Sleeve replacement: A new test sleeve shall be used for each new bushing.

(2) BUSHING SIZE: Bushing to be nominally 5.00 in. I.D. x 3.00 in. L.

- (3) APPLIED STATIC LOAD: Will be sufficient to provide 3300 psi to the test bushing, based on the projected area of the bushing.
- (4) SUPERIMPOSED VARIABLE LOAD: Superimpose a variable load on the bushing of +/- 1000 psi on the 3300 psi test load. For bearing and bearing bond resistance to vibration the vibratory load should be continuously superimposed, except for momentarily stopping during the periods when friction loads and shaft motion are being recorded.
- (5) TEST BUSHING OSCILLATION:
 - (a) MINOR OSCILLATIONS: +/- 1 degree continuously at 2 Hz, except during the major swings.
 - (b) MAJOR SWINGS: +/- 15 degrees once every 15 minutes.
- (6) FLUID MEDIUMS FOR TEST: Air for dry tests, distilled water for the wet tests.
- (7) NUMBER OF TESTS: A full test with each type of bushing running dry, and a full test with each type of bushing running wet is required using the straight test sleeves.
- (8) DURATION OF EACH TEST: 144 hours. This duration is comprised of 24 hours for the set and creep test plus 120 hours for the friction/accelerated wear test.

4. EDGE PRESSURE TEST:

a. **All parameters**, including bushing diameter and test sleeve diameter, material, hardness, and surface finish shall be the same as for the Standard Test except that a DOUBLE TAPER of 0.004 in./in. will be ground on the center of the sleeve to simulate a misaligned shaft. Each taper shall begin at full test sleeve diameter 0.25 in. outside the edge of the test bushing, and shall reach its minimum diameter at the center of the test bushing. For a test bushing having a nominal diameter of 5.000 in. and a length of 3.000 in., each taper on the test sleeve would be 1.750 in. long and have a maximum diameter of 5.000/4.999 in. and a minimum diameter of 4.993/4.992 in.

b. **Loads**, oscillations, and test duration shall be the same as for a Standard Test.

c. **Number of tests:** A full test of each type of bushing running dry only is required.

D. CHART RECORDED TEST PARAMETERS:

The following test parameters shall be recorded on appropriate chart recorder(s):

- a. Radial load
- b. Vibratory load
- c. Oscillation load
- d. Oscillation stroke
- e. Initial set and creep
- f. Wear

Initial set and creep shall be recorded separately from wear.

E. TEMPERATURE MEASUREMENTS: Bushing temperature shall be measured by inserting a thermocouple in a small hole drilled in the bushing (pressure side) as close to the bearing surface as possible and down approximately 1 in. (25 mm) from the bushing end. The hole for the thermocouple shall be filled with heat-conducting grease. Bearing temperature, inlet and outlet cooling water temperatures, and cooling water flow rate may be recorded by any appropriate means. Intervals for temperature recording shall be sufficiently short to define when steady-state conditions are reached, and also whether unusual heat buildup is occurring.

F. COOLING WATER FLOW RATE: Flow may be measured and controlled by any practicable means. Cooling water flow has been calculated to be nominally 53 U.S. gal per hour under maximum conditions, with water inlet temperature at 50 °F, and water outlet temperature at 60 °F. Since this will vary with bushing size, the temperature should be carefully monitored, and the flow controlled (increased) such that outlet water temperature does not exceed 60 °F.

G. LOADS AND STROKES: Loads shall be measured by means of strain gauge load transducers mounted on the cylinder rods, and cylinder strokes measured by means of linear variable displacement transducers integral with the actuating cylinders. Other means of measuring may be used provided such means result in measurements of comparable accuracy.

Number of Samples to be Tested

A. STANDARD FRICTION AND WEAR TEST: (Includes set and creep)

1. DRY RUNNING: One
2. WET RUNNING: One

B. EDGE DAMAGE TEST: One (dry only)

TOTAL: Three

Sketches of Test Equipment

Sketches showing a method for mounting and cooling the test sleeves, test sleeve configuration, and overall test stand layout are shown in Figures A1 – A3.

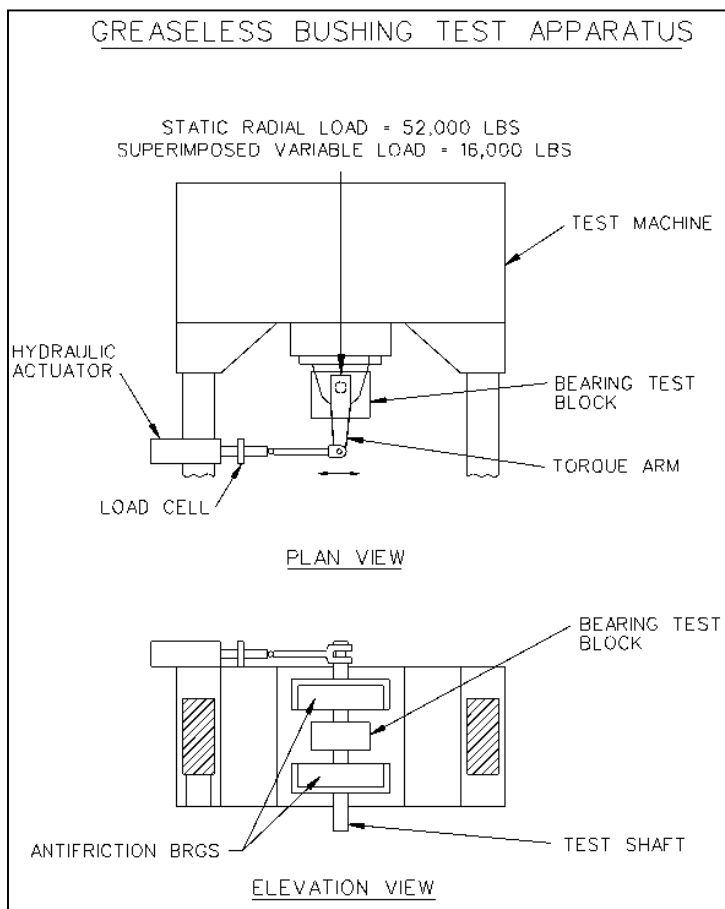

Figure A1. Greaseless bushing test apparatus.

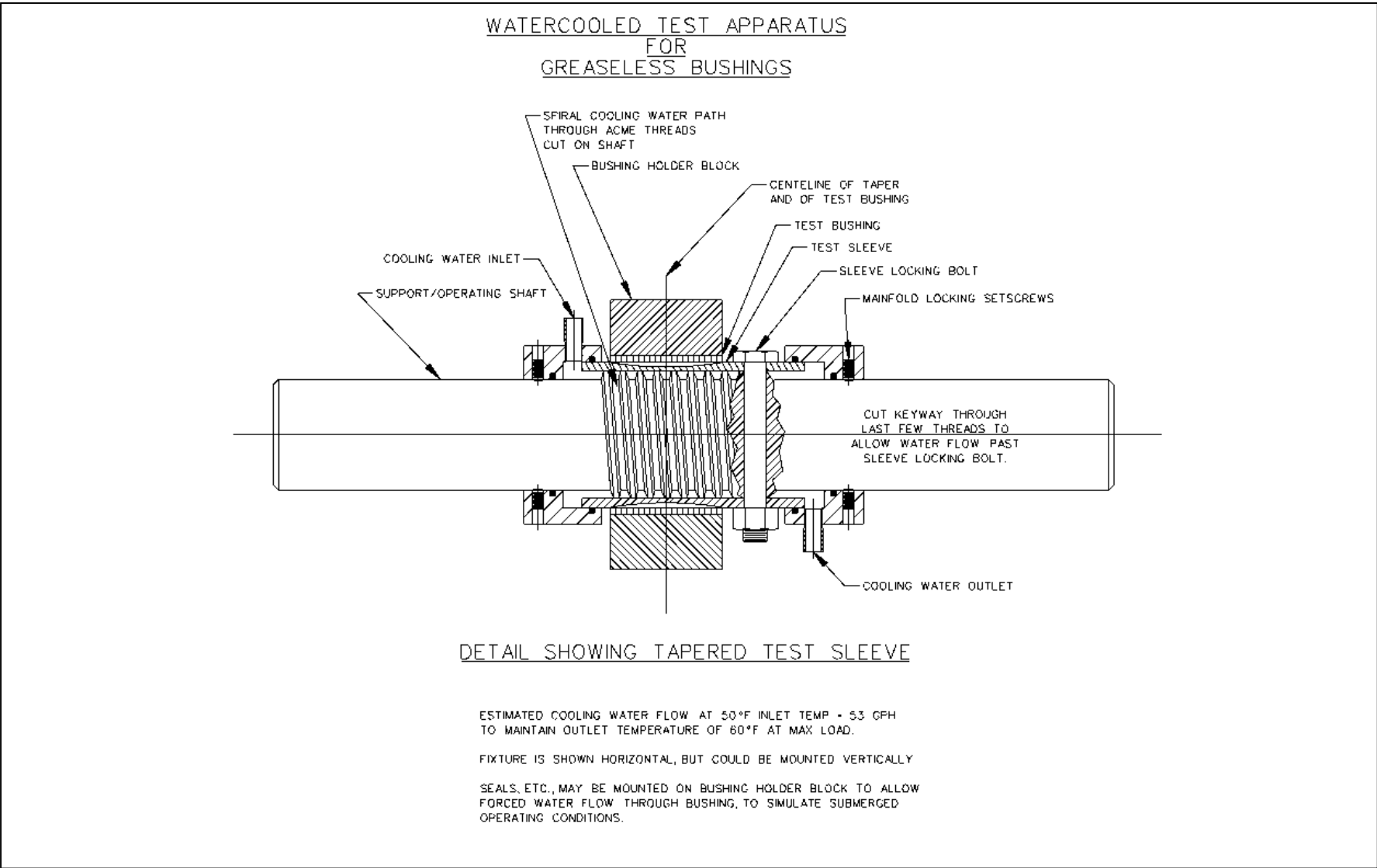

Figure A2. Apparatus detail showing water-cooled test sleeve.

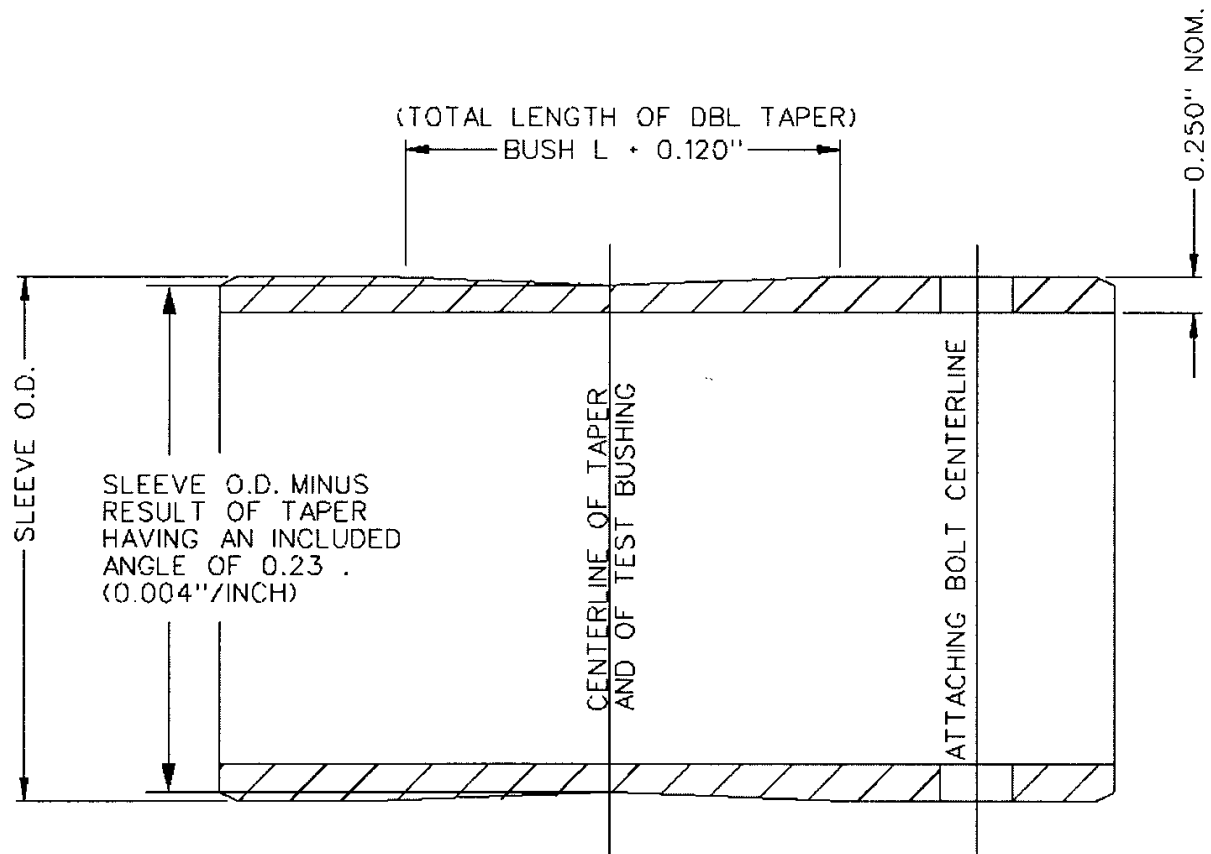

Figure A3. Detail showing tapered test sleeve.

Required Report

The written report shall include as a minimum:

- A. Test description
- B. Photos of samples before and after testing
- C. Results of the tests for material composition
- D. Curves of the test results for each sample, which shall include:
 1. Dry coefficients of friction (static and dynamic)
 2. Wet coefficients of friction, if applicable (static and dynamic)
 3. Set and Creep (Edge damage tests do not require the Set and Creep tests.)
 4. Wear

Scales for the curves shall be in English (U.S.) units.

E. Records and/or comments regarding bearing and cooling water temperatures and water flow rates. This may be in very abbreviated form unless a particular bushing exhibits unusually high or low tendency to heat up. Provide adequate records and comments to fully describe such occurrences.

F. Pertinent comments concerning anything unusual about the test bushings, such as noise or unusual silence, or any breakdown of the bushing from the vibration or the edge pressure test.

Appendix B: Friction and Wear Test Results

Benchmark Testing Performed

Benchmark comparison of the testing of self-lubricating bearings was performed by testing greased and oiled bronze bearings using the exact same test equipment and procedures used to test the greaseless bushings. Bronze alloys and lubricants used were the standard products used at Corps and other hydropower plants.

For the Benchmark Bronze tests, the bronze bushings were alloy UNS93200. The grease used for the greased bronze tests was Esso Argon EP0. This bronze alloy and grease are those used by B.C. Hydro for all their powerplants in British Columbia.

The oil used for the oiled bronze tests was Texaco Regal R&O 320, which came from the Dalles Dam on the Columbia River. Tests were also performed using R&O 68 oil from the Dalles Dam, and they produced essentially the same results as with the heavier oil. The only difference was a slightly higher static coefficient of friction with the lighter oil.

In testing of water-lubricated bronze bushings, common distilled water was used.

Factors Considered in Defining the Tests

Bearing Design Pressure

Information received to date shows that current typical design pressure for turbine bushings is in the range of 2500 to 3000 psi. Several greaseless bushing materials have rated capacity of ten or more times that. In-service wear track areas indicate that, in some cases, actual bearing pressures may be nearer 8000 psi where misalignment or large operating clearance exists, such as blade trunnion bushings.

Review of the literature indicates 3000 psi *on the bearing projected area* to be near the practical limit for turbine design.

Bearing Creep or Extrusion Under Load

Extrusion while under test could be partially the result of heat buildup at the bushing/shaft interface. Forced cooling of the replaceable test sleeve is provided to eliminate that variable. To assure that the test bushing is free to creep or extrude, the sleeve is periodically oscillated during the creep test to relieve any clamping effect. The accelerated wear test procedures separate initial set and creep from indicated wear. Preliminary testing indicates that most initial set and creep occurs within the first 48 hours of the test period if the bearing is not loaded beyond its service capability.

Bearing and Bearing Bond Resistance to Vibration

A superimposed vibratory load of 1000 psi is included to simulate the vibration experienced by wicket gate stem bushings, and it is momentarily stopped when friction loads and shaft motion are being recorded.

Coefficients of Friction

Coefficients of friction are measured, static and dynamic, both wet and dry, to determine the friction torque and stick-slip characteristics of the bearing system. Stick-slip or "stiction" is caused by the difference between static and dynamic coefficients of friction when a system is moved from rest. The more nearly equal the coefficients are, the smoother the system will operate, usually even if actual friction is high.

Wear Rates

Wear rates were measured when operating both wet and dry since operations will be conducted in both environments.

Shaft Material

Virtually all of the greaseless bushing manufacturers recommend the use of corrosion resistant shafts or sleeves in contact with the bushing.

Shaft Hardness

Shaft hardness recommended by the bushing manufacturers varies widely, ranging from approximately R_c 16 (BHN 220) through R_c 60. R_c 40 was selected.

Shaft Finish

Shaft finish recommended by the bushing manufacturers also varies widely, ranging from R_a 0.1 micrometers (4 microinches) to R_a 6.35 micrometers (250 microinches). R_a 0.4 micrometers (16 microinches) was selected.

Bearing Operating Clearance

Manufacturer's recommended clearances were used for the tests.

It is desirable to approach "zero operating clearance" for the tests in order to simulate a well-seated bearing. If this proves successful, users can install the bushings for operation at such reduced clearances. The concept of using essentially zero operating clearance involves providing:

Normal Allowances For:

Bore Close-in from fitting the bushing.

Swell of Material from absorbing either water or oil.

Manufacturing Tolerances.

Special Allowances For:

Temperature:

Only allow for 20 °F temperature difference between the shaft and bushing.

Assembly clearance:

Allow 0.002 in. on the diameter.

Bearing Susceptibility to Damage from Edge Pressure

Equipment that is misaligned for any reason can cause edge loading of bushings to be several times the design load. Bushings that fracture under such loading, or bushing bond to substrate that fails, may lead to complete failure of the bushing.

The standardized test includes testing for susceptibility to such damage by machining those test sleeves with a small double taper toward the middle, beginning just beyond each end of the test bushing, to simulate a misaligned shaft. Two overloaded ends from each tested bushing are then available for examination. A taper of 0.004 in. on the diameter per inch of bearing length is applied on the test sleeve to provide the required edge loading.

Test Medium for the Wet Tests

Distilled water is used for the wet tests because it provides test reproducibility. Friction and wear are slightly affected by dissolved minerals and also by minute abrasive particles found in tap water.

Testing for Abrasion Resistance

The bushings are not tested for abrasion resistance because other researchers have found that no known test method yields reproducible results.

Heat Buildup in the Bearing

Forced water cooling of the test sleeve is used to assure that the temperature of the test sleeve surface on the pressure side of the bushing does not exceed 35 °C. This temperature is the highest operating environment temperature recorded at any Corps hydropower installation.

Bearing Size

Test bearings are 5 in. in diameter by 3 in. long. The size was chosen to be large enough to reasonably extrapolate information up to the size of a wicket gate stem bushing, and small enough to only require a reasonable test load.

Motion Of the Test Shaft

Type

Oscillatory to duplicate the type motion most of the mechanisms undergo.

Angles of Oscillation

Many small motions coupled with infrequent large motions, similar to wicket gate and blade motions.

Frequency of Oscillation

Highest practicable frequency to obtain wear information within a reasonable test time. For these tests the frequency is 2 Hz.

Duration of the Test

Twenty-four hours for the initial creep test, followed by 120 hours of wear test. The wear test involves more than 860,000 cycles, which is equivalent to 4 degrees of rotation every 73 seconds for 2 years. One hundred hours on the test stand represents wear equal to approximately 14 years of wicket gate service, based on these field tests.

Description of Test Apparatus

1. The test procedure is described in Appendix A. The test apparatus shown in Figures A1 and A2 consists of a vertical shaft supported by two self-aligning, double-row, antifriction bearings capable of sustaining a radial load of 52,000 lb, plus a superimposed load of 15,760 lb. The 52,000 lb load produces 3300 psi load on the test bearing. The superimposed load of 15,760 lb produces 1000 psi variable radial load.
2. A replaceable water-cooled test sleeve is fitted to the vertical shaft.
3. A block containing the self-lubricating bushing under test is mounted between the two support bearings and rigidly prevented from rotating.
4. Test bushings are fitted to the test block by means of appropriate adapter sleeves as required. The adapter sleeves provide the proper bushing fit as specified by the bushing manufacturer.

5. All loads and shaft oscillation motions are applied using computer controlled hydraulic cylinders equipped with load cells.
6. All measurements are computer monitored and recorded.

Test Results

Test result charts are shown in Figures B1 through B9.

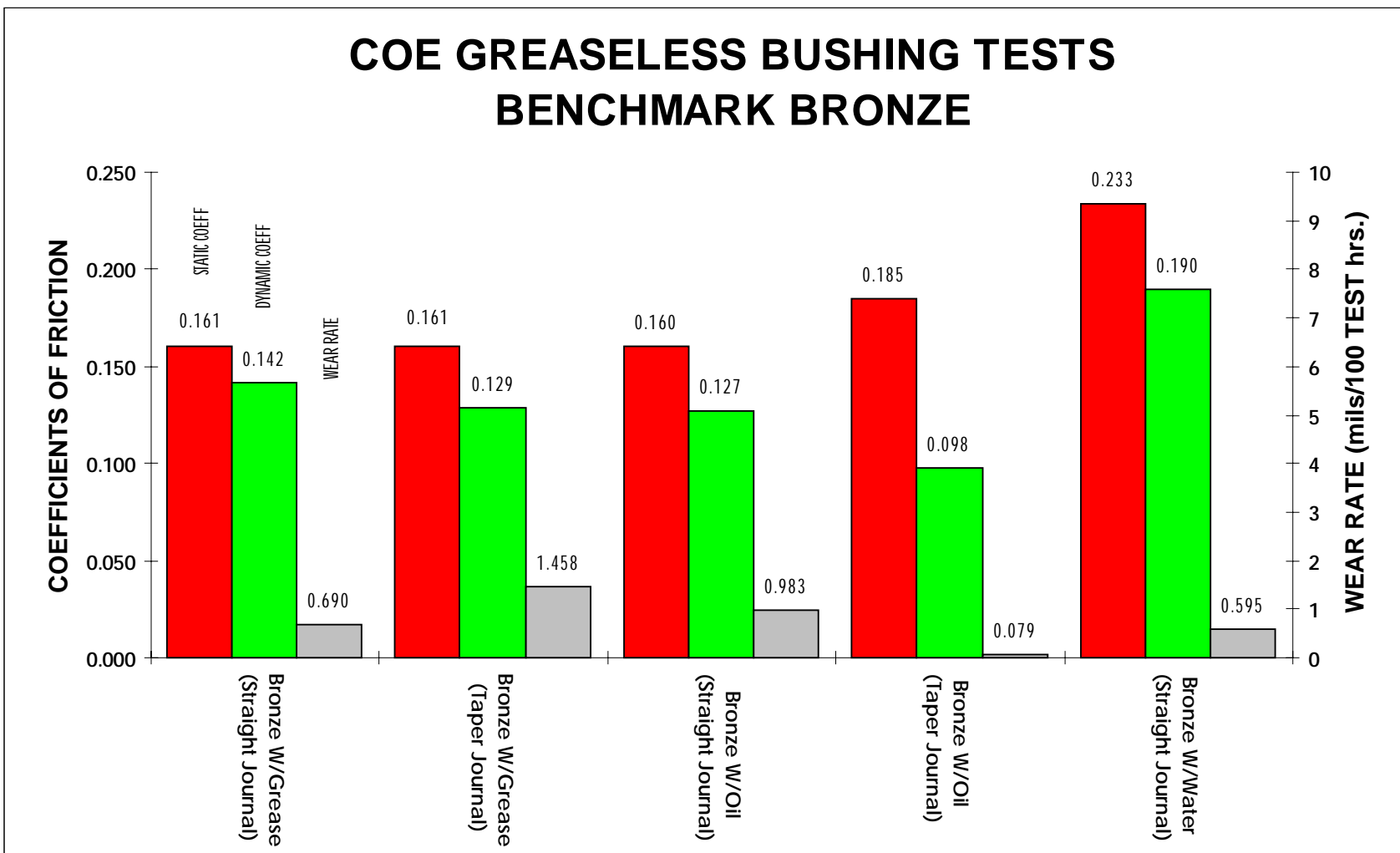

Figure B1. Greaseless bushing tests — benchmark bronze.

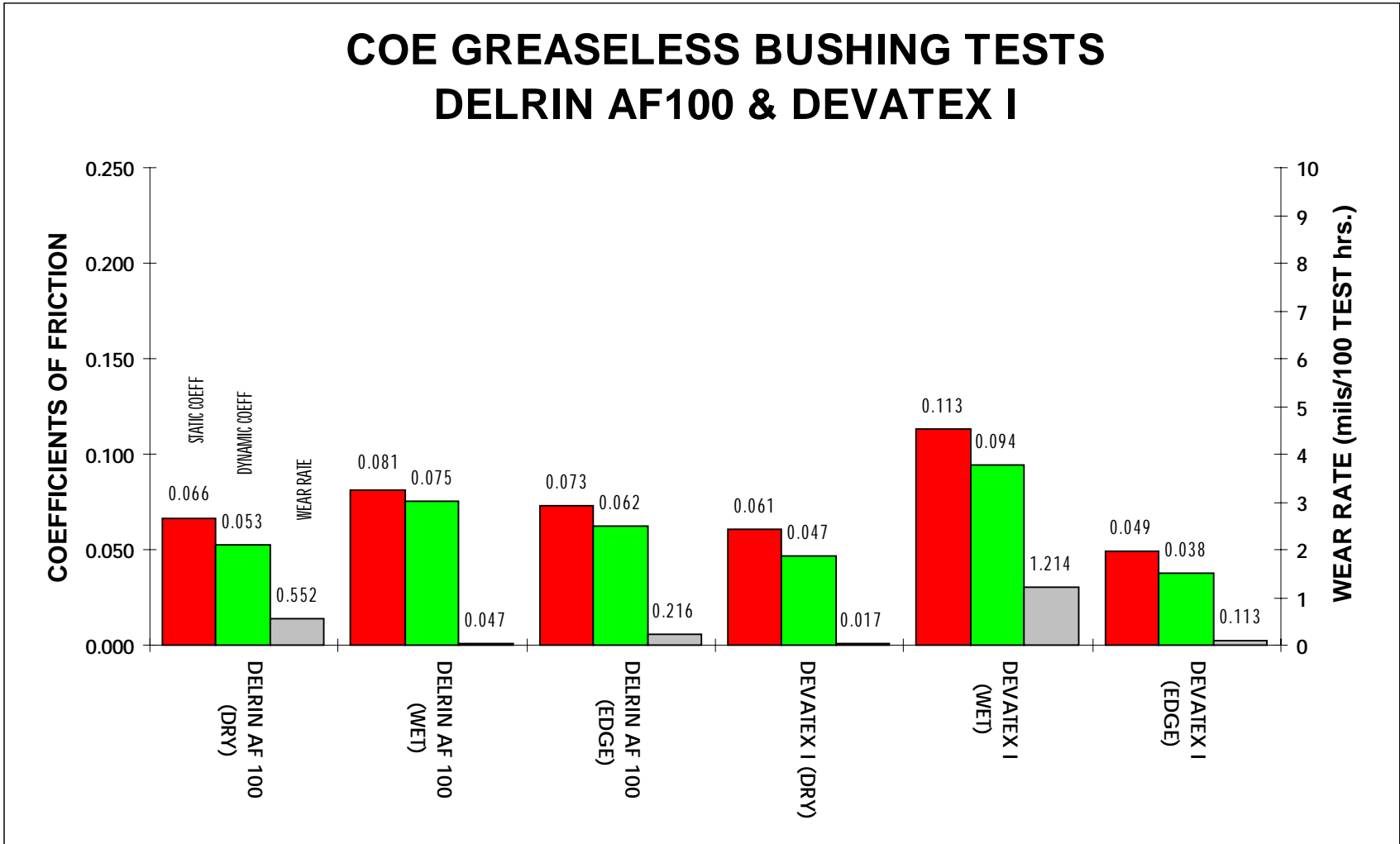

Figure B2. Greaseless bushing tests — Delrin AF100 and Devatex I.

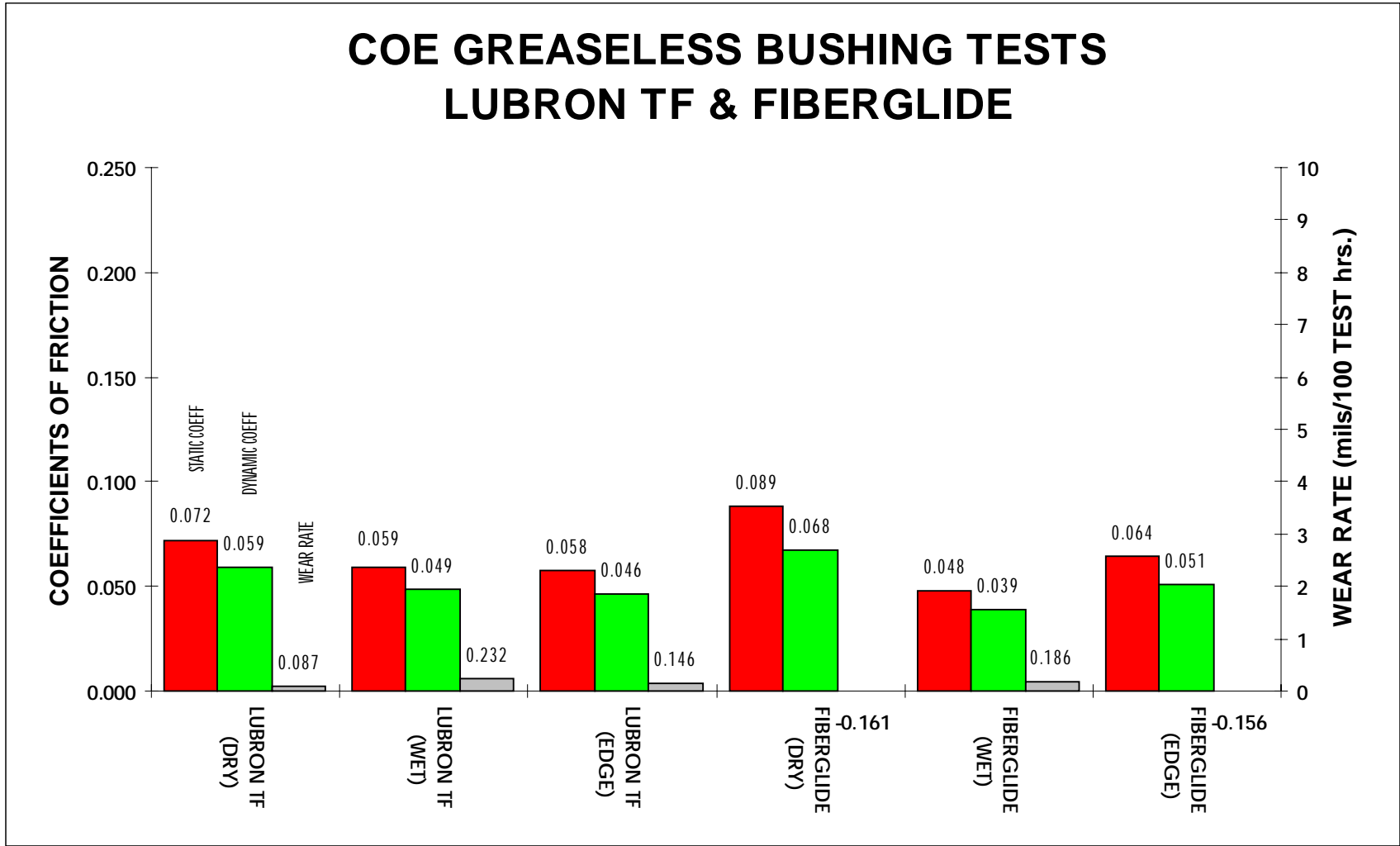

Figure B3. Greaseless bushing tests — Lubron TF and Fiberglide.

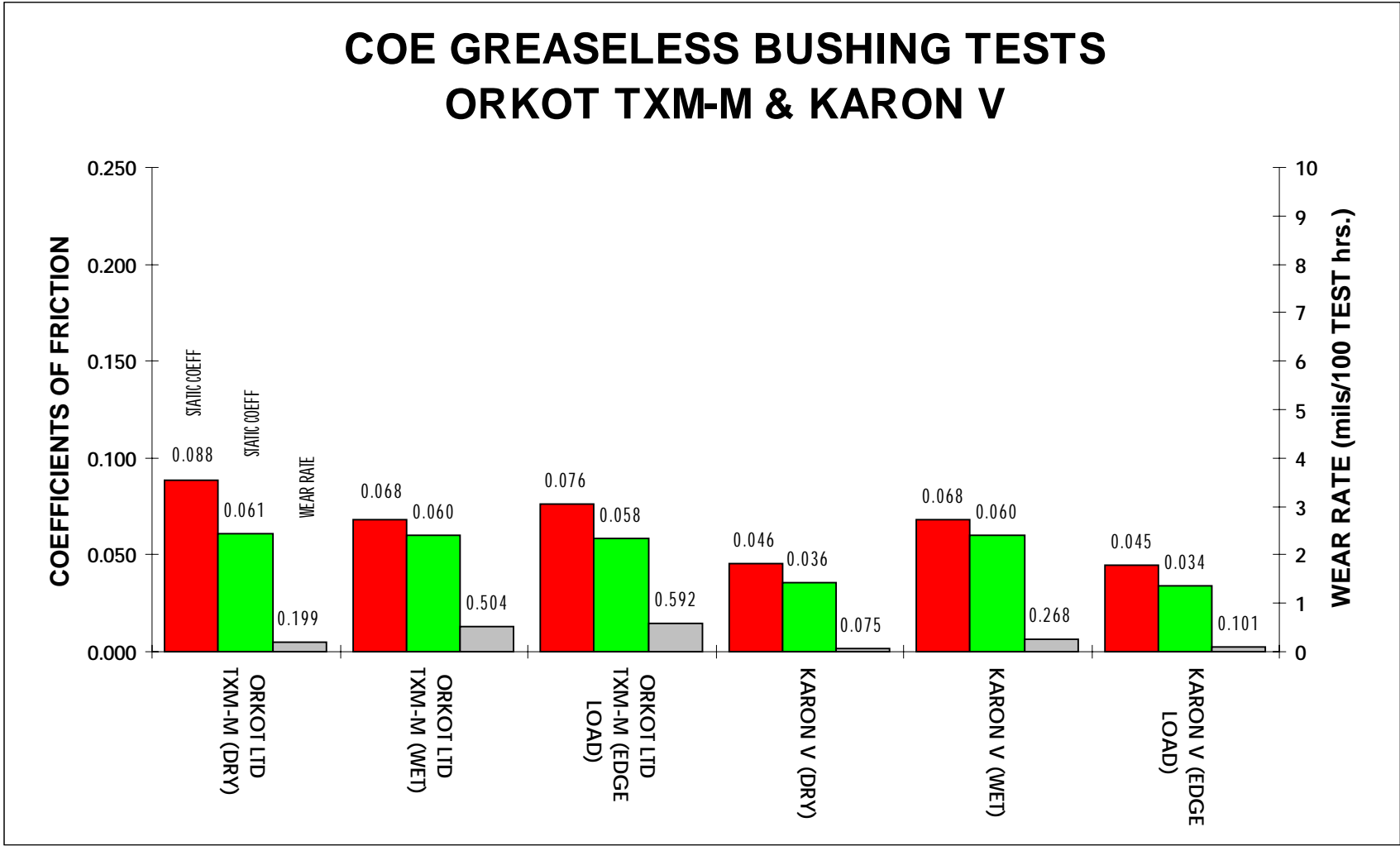

Figure B4. Greaseless bushing tests — Orkot TXM-M and Karon V.

COE GREASELESS BUSHING TESTS

KARON V & F @ 8,000 PSI

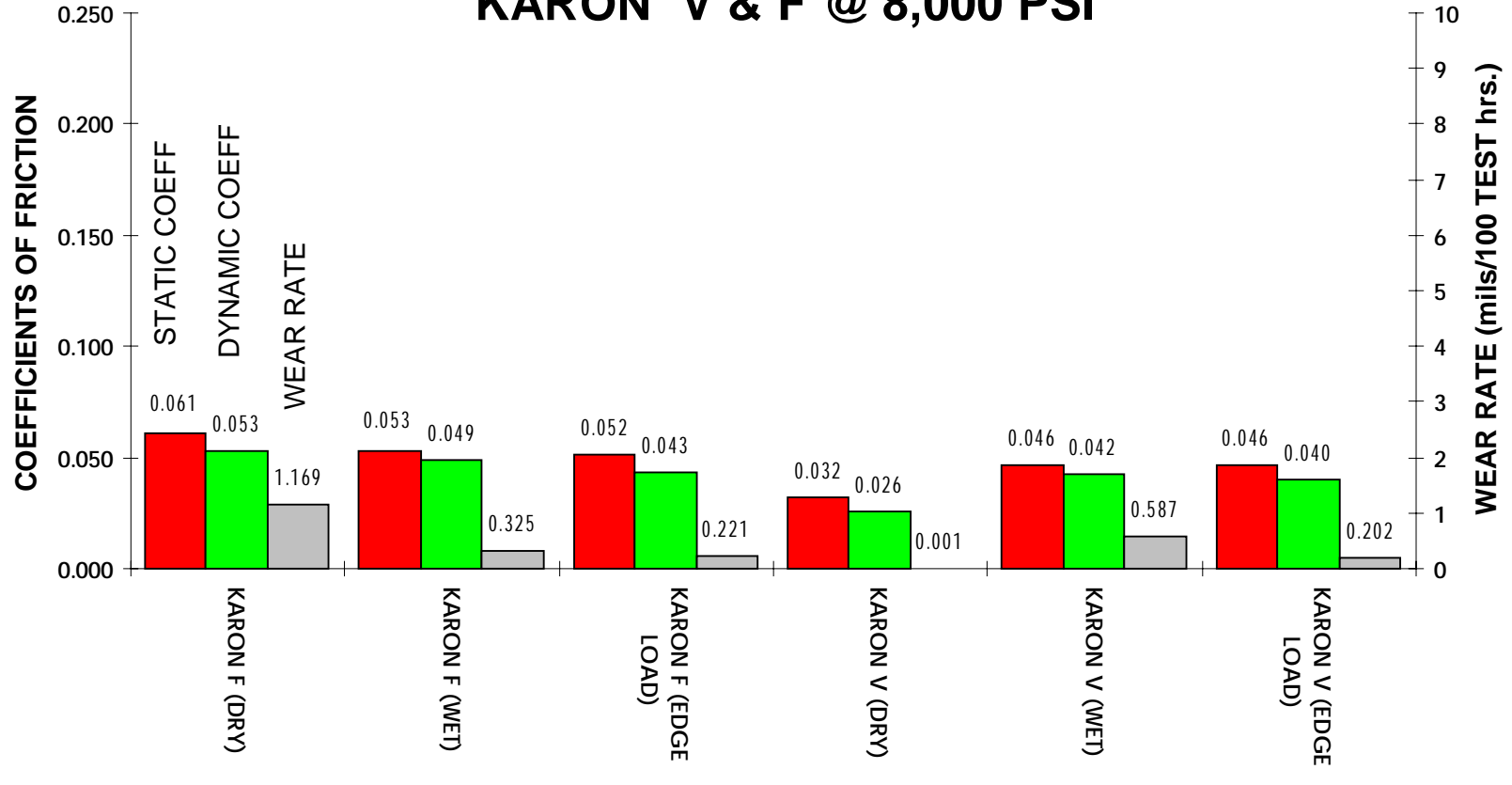

Figure B5. Greaseless bushing tests — Karon V and F@8,000 psi.

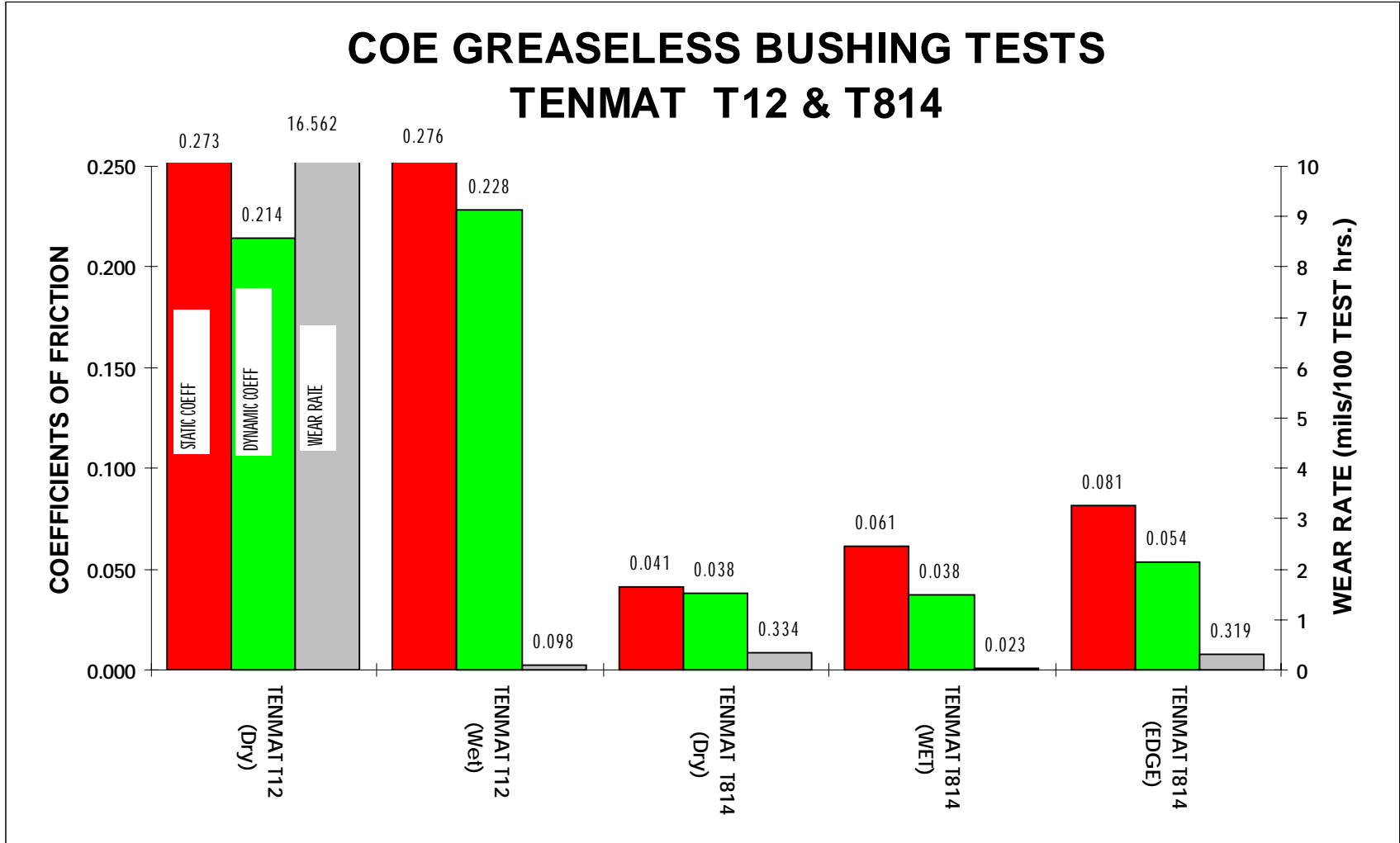

Figure B6. Greaseless bushing tests — Tenmat T12 and T814.

COE GREASELESS BUSHING TESTS THORDON TRAXL SXL & HPSXL

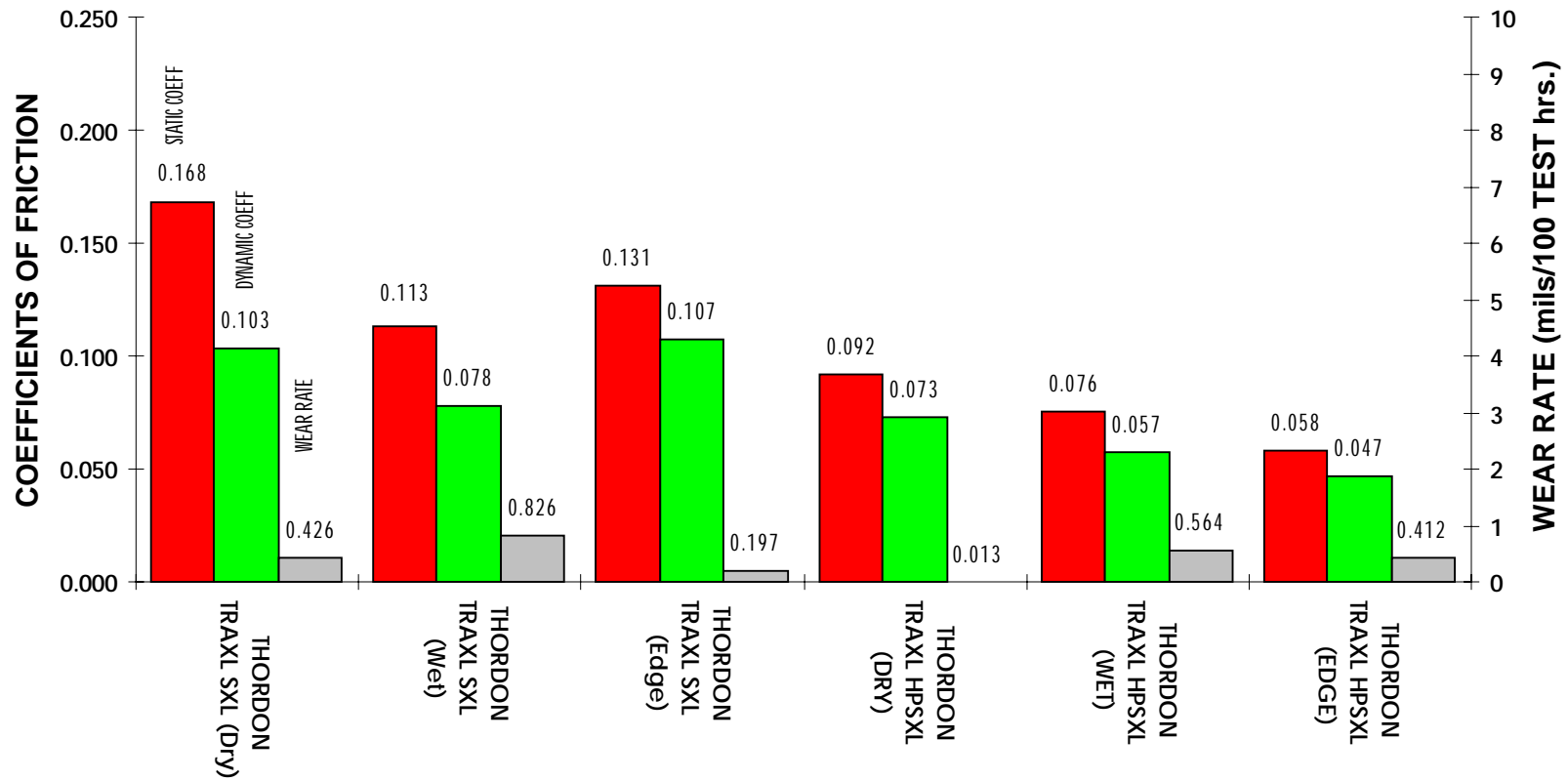

Figure B7. Greaseless bushing tests — Thordon TRAXL SXL and HPSXL.

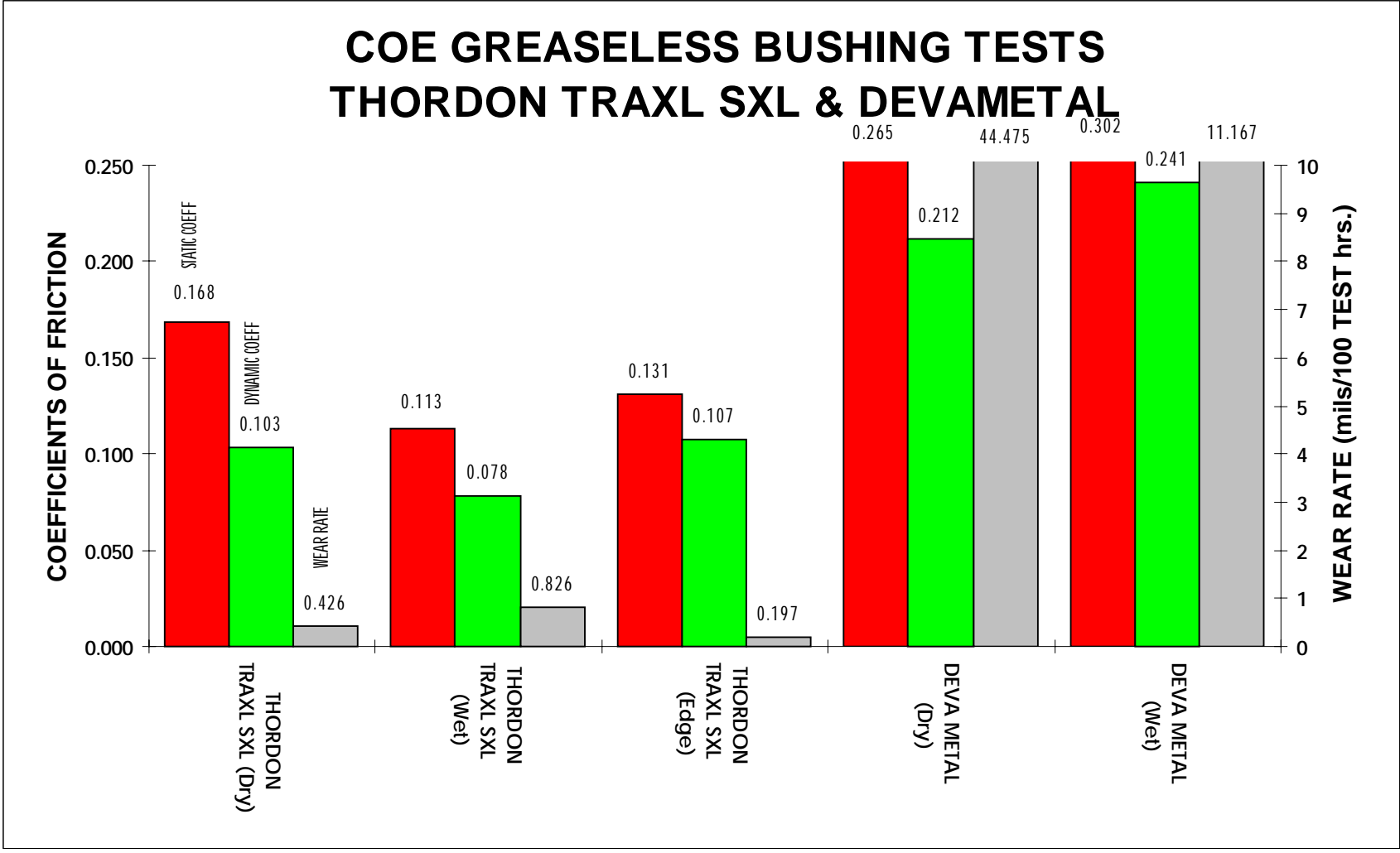

Figure B8. Greaseless bushing tests — Thordon TRAXL SXL and Deva Metal.

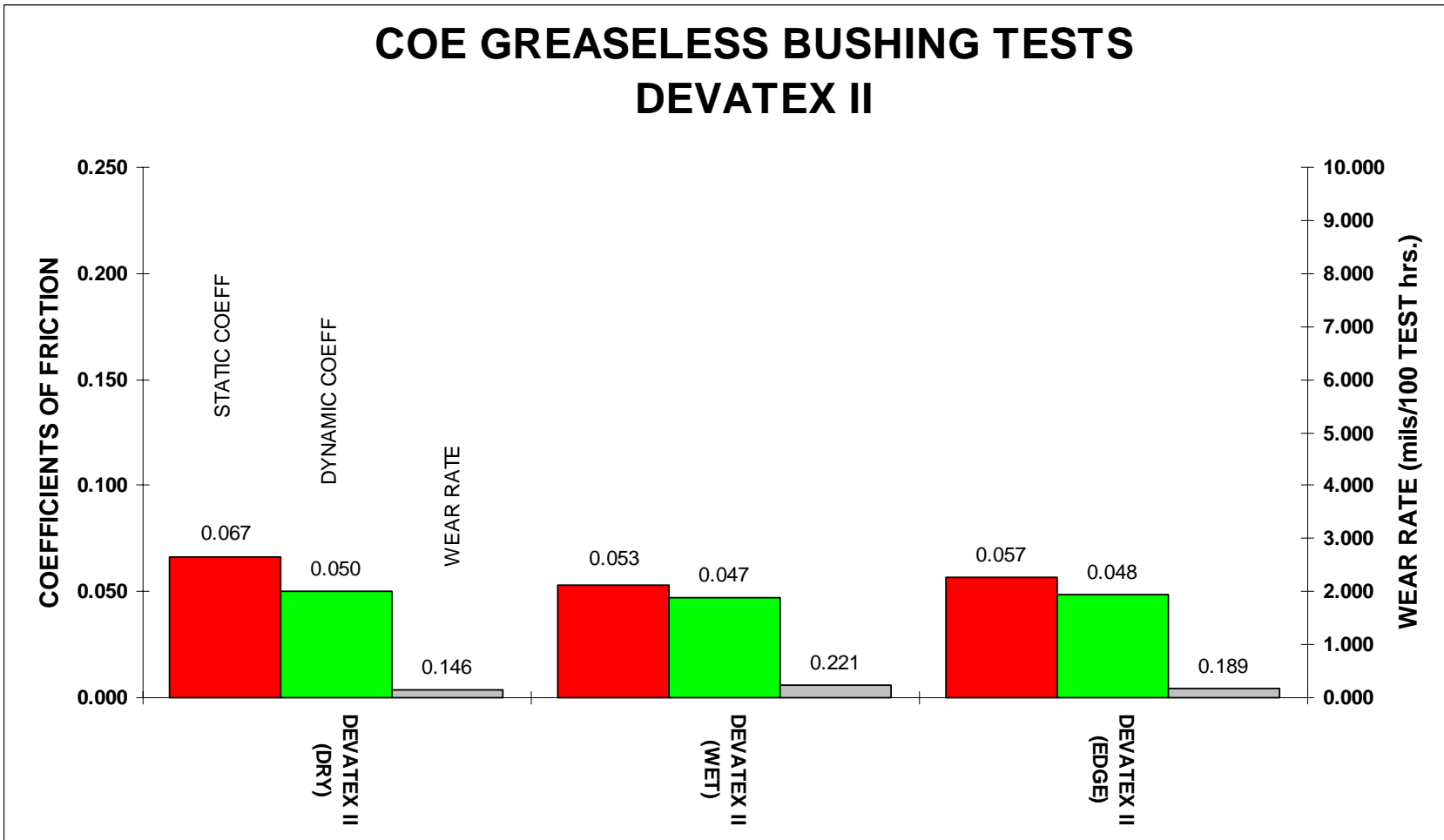

Figure B9. Greaseless bushing tests — Devatex II.

Recommendations

The following comments are intended for application to turbine wicket gate stem bushings, wicket gate and turbine blade operating mechanisms, and any other bushings in that size range used by the Corps. For other applications, such as turbine blade trunnion bushings, these comments and recommendations may not be applicable without further testing.

Pressure

Test the bushing material at 3300 psi nominal. Design for operation at 3000 psi or less.

Test Sleeves and Service Shafts or Sleeves

Use heat-treated 17-4 PH or equivalent with a hardness of R_c 28-32 (BHN 271-301). Use surface finish R_a 0.4 micrometers (16 microinches) or better for all applications.

Operating Clearance

Use minimum operating clearance after accounting for all factors which contribute to bearing close-in.

Stiction

Of the several greaseless bushing materials that by test may prove satisfactory for a given hydropower application, the material(s) having the least "stiction" strain energy are recommended.

Seals

Use wipers and seals on all underwater installations, and all others as required, to exclude foreign matter.

Developments in Progress

Industry Participation in Bushing Testing

Some bushing manufacturers have already paid for testing of their materials, using the test procedure and test apparatus, and have allowed the test results to be

included in the project database. In return for their participation in the program, they have received the results of all previous testing, and will receive updates as testing of each new material is completed. This sharing of costs and information is resulting in a usable database much earlier than could be developed by the Corps alone. The testing program and information sharing have prompted several manufacturers to produce new and better products and others to undertake new product development programs.

Modification of the Bushing Tests

If future test results indicate it is necessary, the tests themselves will be modified to obtain the most reliable bushing performance information.

Lessons Learned from This Testing Program

Coefficients of Friction

- Are often significantly higher than manufacturers' published values.
- Differ widely between materials, sometimes by as much as 5:1.
- Are sometimes higher when the material is wet, but most materials have lower friction coefficients when wet.

Wear Rates

- Wear rates of some better known materials have more than 10 times the wear rate of some of the less well known materials.
- Wet wear rates of many materials are higher than dry wear rates.

Use of Seals

In the absence of specific test information, and with the knowledge that a greased bronze bushing is able to partially exclude and purge dirt through frequent greasing, **the use of seals on every greaseless bushing exposed to water or the outside atmosphere is strongly recommended. If the bushings are submerged, they will be operating wet very soon, even with seals. Seals are to exclude sand, silt, wind-blown dirt, etc.**

Use of Stainless Steel Shafts

It is essential that the greaseless bushings be used with either a stainless steel shaft or stainless steel sleeve as the journal material, even

when the application is a “dry” one. Without grease to exclude moisture, corrosion of any non-stainless shaft will eventually cause failure of the bearing either by seizure or excessive friction and wear.

Shaft Finish and Hardness

A surface finish of 16 microinches, and a hardness of R_c 28-32 (BHN 271-301) are specified for the sleeve material. These values have been found to perform well in tests, are readily attainable, and are consistent with recommendations of virtually every bushing manufacturer contacted.

Test Result Confidence

Tests show that there are several greaseless bushing materials that outperform greased bronze by a factor of 2 to 5 when kept clean. **At this time there is no reason to assume that the bushing performance relative to bronze will differ from that found in these tests;** but a greased bronze bushing has the advantage of partially purging the accumulated dirt each time it is lubricated.

Present Database

Through this test program, with the participation of the bearing manufacturers, a sizeable database on self-lubricating bearings has been accumulated. Charts of the test results are included in this appendix, and the researchers believe the test results accurately depict the performance characteristics of the tested bearings for use in hydropower applications.

Reference

R.A. Palylyk and M.J. Colwell, *Self-Lubricating Bushing Project, Project 2200-30* (Surrey, BC, Canada: Powertech Laboratories Inc., 1991).

Appendix C: Correlation of Wear Test Results to Service Life

Overview

To determine the length of real-world service life represented by 100 hours on the test stand, six surplus computers were modified to monitor movements of the wicket gates and turbine blades. A computer program was developed to convert the signals from the governor transducers into data usable to determine turbine component rotation.

The most active units at each project were selected for monitoring. This information was to be gathered from four projects, which included both Francis type units and Kaplan (adjustable propeller) type units, over a period of 1 year. The data that were collected should have provided both annual and seasonal component motion information. However, problems with weather, software debugging, and other factors prevented the program from being fully implemented. Only one of the projects reported usable data, but only for a duration of 4 months. The only turbines monitored at that site were Francis-type turbines.

Under the conditions noted above, the monitoring program showed conclusively that between 75 and 90 percent of all wicket gate motions are less than 0.2 percent of full gate motion. This percentage amounts to approximately 0.11 degrees of rotation per motion on these units.

This finding verified that the small motions used on the test stand closely resemble actual turbine component motions, and that a duration of 100 hours on the test stand represents approximately 14 years of actual turbine operation.

Description of the Monitoring Program

Blade and wicket gate position information is gathered by Linear Variable Displacement Transducers (LVDTs) connected to the servo mechanisms of each turbine. The voltage signal from the LVDTs is split, the signal going both to the

turbine governor and to the monitoring computer. The monitoring program first is calibrated to "Zero Gate" or "Zero Blade angle" when the gates are fully closed or the blades are fully flat, respectively. The gates are then calibrated to "100 percent Gate" or "100 percent Blade Angle" when the gates are fully open or the blades are at full steep angle respectively. The program remembers the voltage *range* found during the calibration procedure as "100 percent."

The program continuously monitors the voltage signals from the LVDTs *watching for change in voltage*. When the voltage signal is steady, the program watches the signal and updates it more than 20 times a second. When the signal begins to change, the program remembers the voltage at the start of motion, and also records the voltage when motion (*voltage change*) ceases. The program then computes the *change of voltage* between start and stop of motion and converts that information into "Percent of Gate" or "Percent of Blade" motion, respectively. The motion information is then stored in "counters."

Motion changes are recorded in 0.2 percent increments from no motion through 15 percent motion. Any motion greater than 15 percent of full gate is lumped with, and counted as, "15 percent" because such motions are representative only of start-up or shut-down of a unit and are very infrequent compared to all other motions. A signal voltage *change* equivalent to "1.6 percent" is counted as *one motion* and is summed in the "1.6 percent" counter. This is typical for all motions, and the data printout shows only as: "0.2% = 7040", "1.6% = 21", and "15.0% = 1", etc.

Every motion is measured and counted, regardless of *direction*. If some motion increments do not occur, as when all motions were either smaller or larger than the specific increment, there is no entry for that increment in the printout.

Summary of Turbine Data

Number of Gate Motions per Week

The number of gate motions of each incremental size per week was averaged over a 17-week period. A sampling of the averaged results follows:

0.2 percent gate moves =	7100
0.4 percent gate moves =	<500
0.6 percent gate moves =	<200
3.0 percent gate moves =	<5
10.0 percent gate moves =	1.3
15.0 percent or greater =	1.4

Typical Size of Motions

The program showed conclusively that between 75 and 90 percent of all wicket gate motions **on these units** are less than 0.2 percent of full gate, which is approximately 0.11 degree of rotation.

Motions Greater Than 3.0 Percent

Motions greater than 3.0 percent averaged one per week or did not occur at all.

Operation on Automatic Gate Control (AGC)

It is possible for a unit to be operating only on "load control" mode and have substantially more of the larger gate motions and (relatively) fewer of the small motions than are represented above. Previous testing has shown that, for the distance traveled, the small movements cause much more damage and wear than the larger movements.

Conclusions

1. The bearing test stand procedure closely resembles actual component motions in the "real world."
2. Accounting for wicket bearing diameters being 10 in. (twice the size of our test bearings), and that the test stand was only oscillating at +/- 1 degree, instead of +/- 2 degrees as intended, 100 hours on the test stand represents approximately 14 years of actual turbine operation.

The information that this program could provide would be extremely useful in predicting actual service life of a turbine, regardless of what type bearings it was equipped with. It is not just the hours that a turbine is on-line that is important, but the type of service it is providing as well.

Recommendation

This program should have the technical problems resolved, and be funded through completion.

Appendix D: Description of Swell Testing Program

Sample Dimensions

Samples may be either cylindrical or rectangular as described below.

a. Cylindrical:

1. I.D.: 1.968 in. \pm 0.004 in.
2. Wall thickness: 0.0787 in. + 0.005 in., -0.000 in.
3. Length: 1.968 in. \pm 0.005 in.

b. Rectangular:

1. 1.968 in. x 1.968 in. x 0.0787 in.
2. Size: \pm 0.005 in., Thickness: +0.005 in., -0.000 in.

Number of Samples of Each Material

- a. For water test - 2
- b. For oil test - 2

Sample Cleaning and Handling:

a. **CLEANING:** Before starting on any of the test procedures, including marking, soaking, and measuring, the samples must be washed thoroughly using a commercial dishwasher-grade detergent such as "ALL" to remove all oily residue from the surfaces of the material samples. The intent is to lightly brush-scrub the samples in warm water, using the dishwasher detergent, to remove all non-bearing materials from the surface insofar as is practicable. This washing should remove any break-in lubricants if possible, since the idea is to see how the bearing material, or substrate material, swells during prolonged soaking. After washing and rinsing the samples thoroughly, wipe them dry, then place them on

suitable racks and let them air dry for 24 hours before proceeding to mark and measure them.

b. **HANDLING:** Wear latex surgical gloves, or equal, throughout the entire test when handling the samples. This includes during washing, marking, and measuring each sample.

Sample Marking

(See drawing at right.)

a. **IDENTIFICATION:**
Each sample is to be identified by marking "A1", "A2", "A3", "A4"; "B1", "B2", "B3", "B4"; "C1"...etc.; where the letter is used to denote the sample material, and the numeral identifies which sample of that material is in hand.

b. **MARKING MEDIUM:**
Use a permanent marker that will be durable and visible, even through an oil film, for the entire test period. This marker may be any suitable commercial marker, including paint, that is deemed appropriate.

c. **CYLINDRICAL SAMPLES:**

1. **AXIAL MARKING FOR LENGTH MEASUREMENTS:** Each sample is to be marked on the cylindrical surface, near each end, on each of two axial lines spaced approximately 90 degrees apart. Label one axial line (1), and the other axial line (2). Markings are to assure that all length measurements are made at the same locations and correlated with all prior measurements of that sample. Marks should be small, and not extend to the end of the sample so that material size change will not be affected by the presence of the marking medium.

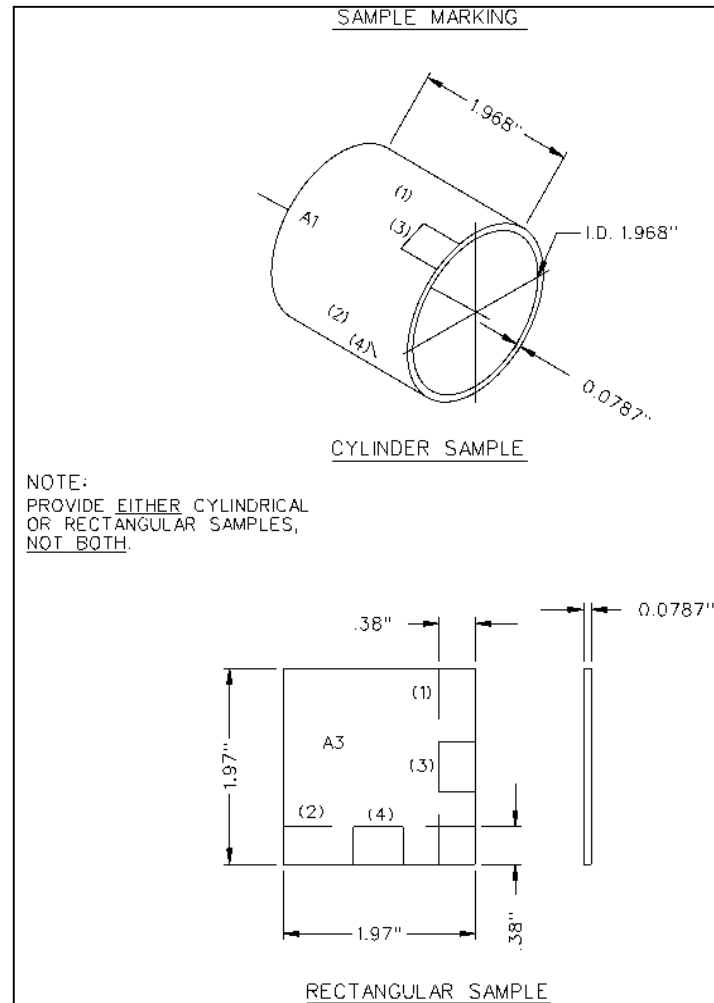

2. SPOT MARKING FOR THICKNESS MEASUREMENTS: Each sample is to have two spots marked on the cylindrical surface on one end, approximately 3/8 in. from the end and approximately 90 degrees apart. Label one spot (3) and the other spot (4). Markings are to assure that all thickness measurements are made at the same locations and correlated with all prior measurements of that sample. Marks should be small, and not extend over the intended measuring point so that material size change will not be affected by the presence of the marking medium. DO NOT MEASURE ON THE MARKING MEDIUM.

d. RECTANGULAR SAMPLES:

1. LENGTH MARKING FOR MEASUREMENTS: Each sample is to be marked in two places, on one side only, parallel to two adjacent edges, approximately 3/8 in. from the edges. Mark one line (1) and the other line (2). Markings are to assure that all length measurements are made at the same locations and correlated with all prior measurements of that sample. Marks should be small, and not extend to the edge of the sample so that material size change will not be affected by the presence of the marking medium.

2. SPOT MARKING FOR THICKNESS MEASUREMENTS: Each sample is to have two spots marked on the flat surface, approximately 3/8 in. from the edge(s). Label one spot (3) and the other spot (4). Markings are to assure that all thickness measurements are made at the same locations and correlated with all prior measurements of that sample. Marks should be small, and not extend over the intended measuring point so that material size change will not be affected by the presence of the marking medium. DO NOT MEASURE ON THE MARKING MEDIUM.

Sample Support Method in Fluids

a. SUPPORTING MATERIALS:

1. CONTAINERS: Any non-conducting and non-reactive material suitable for holding the oil will be satisfactory.

2. BOTTOM STAND-OFF MATERIAL: Stainless steel wire cloth, approximately 2 x 2 mesh, or suitable High Density Polyethylene hardware cloth having a nominal opening of 0.45 in. Material is to be spaced approximately 1/2 in. off the bottom of the test containers. Both materials are available from McMaster-Carr, and others.

b. SAMPLE POSITION:

1. CYLINDRICAL SAMPLES should be stood on end, and submerged so they are covered by approximately 1/2 in. of the test medium.

2. RECTANGULAR SAMPLES would preferably be suspended on edge, but may be laid flat on the bottom stand-off material. The samples should not overlap or touch in any way. Samples should be submerged to a depth of approximately 1/2 in. in the test medium.

Fluids for Test

a. WATER: Use DISTILLED water. *Water should be changed once per month, and material samples flushed off under running tap water each time the water is changed.*

b. OIL: R&O 68 TURBINE OIL

Fluid Temperature

68 °F to 72 °F

Sample Support Method for Taking Measurements

a. CYLINDRICAL SAMPLES: It is recommended that cylindrical samples be supported in, and lightly secured to, a "VEE" block to facilitate the required measurements.

b. RECTANGULAR SAMPLES: It is recommended that rectangular samples be supported on, and lightly secured to, a flat block having stops in two directions to facilitate the required measurements.

Measuring Instruments

a. TYPE: Micrometer, electronic, friction thimble equipped. Thickness measurements of cylindrical samples will require a micrometer that has a spherical anvil.

b. ACCURACY: ± 0.0001 in.

c. RESOLUTION: 0.00005 in.

d. CLEANING: After completion of each set of measurements required for the oil swell tests, the micrometers must be carefully cleaned, particularly the anvil and spindle faces, before using them for measurements of the water swell test samples. This cleaning is to eliminate contamination of the water swell test samples with oil and possibly affecting the water absorption.

Measurement Locations

All measurements will be made at the locations specified in **Sample Marking** (page 58) and shown on the accompanying sketch.

Measurement Recording

Use the Excel data sheet format enclosed as Exhibit A. At each measurement interval, record in the appropriate boxes the date and the measured value for each location on each sample. Excel will automatically take the average of four measurements, from two samples, and plot that average value as a point on the scatter charts.

Measurement Intervals

- a. Initial set of measurements taken at start of test.
- b. First series of measurements taken once each week for the first 12 weeks.
- c. Final series of measurements taken once every 4 weeks until the end of testing.

Report

- a. TABULATED RESULTS. Include computer processed copies of the raw data in the EXCEL format shown on Exhibit A.

b. GRAPHICAL RESULTS:

1. Provide, for each material, for water swell and for oil swell, a separate “smoothed line” X-Y scatter chart showing:

a. The average change in length of the sample as a function of time.

b. The average change in thickness of the sample as a function of time.

(This will produce four charts for each material.)

2. Provide, for water swell and for oil swell, a bar chart showing the average change in length per unit length as found during the last weeks of the test. Show all materials on one chart.

(This will produce two charts.)

3. Provide, for water swell and for oil swell, a bar chart showing the average change in thickness per unit thickness as found during the last weeks of the test. Show all materials on one chart.

(This will produce two charts.)

c. DISKETTE: Provide the above information, including the charts, on high density diskette(s).

Appendix E: Swell Test Results

Overview

Development of Test Procedure

A test procedure was developed to determine the “swell,” or change in thickness and length and width of standardized samples of bearing materials when soaked in either water or oil. The purpose of the test procedure was to determine, as closely as possible, the maximum VOLUME change of the bearings that could be expected when subjected to indefinite immersion in either water or oil. Thin samples (2 millimeter thick) were specified to assure that the material would reach maximum swell in some reasonable time (e.g., 1 year).

Test Instructions

Explicit instructions for sample size and number of samples, for cleaning, handling, marking, soaking, and measuring of the samples, and for recording of the data. Specific type and accuracy of the measuring instruments were specified as well as specific time intervals between measurements. Test room temperature was to be maintained between 68 and 72 °F.

Results of Testing

Results of testing for 8 months are included in this report, and the results indicate that:

1. Between 90 and 95 percent of full swell has occurred by the end of 8 months. Full swell of most material samples would apparently occur in less than 14 months.
2. Swell of most of the tested materials is small. Even the materials having the largest degree of swell should present no problem when normal bearing thicknesses and clearances are used. A Kamatics Karon V bearing having a 0.460 in. thick composite backing and 0.040 in. thick bearing layer would

require only slightly over three thousandths of an inch diametrical clearance allowance for swell in water.

3. Some materials exhibited a *decrease* in volume during testing. Two materials decreased in volume while soaking in water, and all except one decreased in volume while soaking in oil. Every point on the swell charts is the average of four measurements of two samples taken within minutes of each other. Some of the “laid up” materials decreased in dimension in all directions, while others increased in one or more directions while decreasing in the third direction.
4. Some of the materials apparently soften on the surface in water, and some are softened by oil — probably all the way through. More investigation of this phenomenon is required.

Recognition of the Need for Material Swell Data

Reports were received over the years of various greaseless bearing materials swelling in service and causing seizure when used as wicket gate bearings (e.g., the Aswan Dam in Egypt). This problem prompted the requirement for answers to the questions of swell before starting to widely install greaseless bushings in Corps hydropower projects. Regardless of other performance characteristics, proper (but not excessive) installed clearances must be assured.

Development of a Material Swell Test

To develop a material swell test it was necessary to specify as a minimum the following parameters:

1. Sample shapes and dimensions.
2. Number of samples for each test.
3. Description of sample cleaning, handling, and marking of measurement locations.
4. Sample support materials and sample position during soaking.
5. Fluids for test and maintained test temperature.
6. Type and accuracy of measuring instruments to be used.
7. Cleaning of measuring instruments during measurement activities.
8. Measurement recording.
9. Measurement intervals.

10. Materials to be tested.
11. Form of report.

For uniformity of reporting, the spreadsheet and the required chart types were developed in-house and provided to the testing laboratories. As data was entered into the spreadsheet, all charts were produced automatically. The swell test description is documented in Appendix D.

Results of the Material Swell Tests

Figures E1 and E2 show the diametrical clearance required for swell, based on a “standard” bearing. Figures E3 through E34 are the developed scatter charts, some of which include trend lines, and Figures E35 through E38 are the developed bar charts for swell.

The “standard” bearing used in the calculations for required diametrical clearance due to swell is as follows:

- Shaft diameter (and inside bearing diameter): 9.00 in. (Same as the Bonneville I wicket gate shafts.)
- Total bearing wall thickness: 0.500 in. (Same wall as Dardanelles and later.)
- Lubricant liner layer thickness (when used): 0.040 in.
- Backing layer thickness (when used): 0.460 in.

The volume change for the liner and the backing are computed separately then added together. The entire volume change of the bearing is assumed to occur in an inwards radial direction, then the resulting bearing inside diameter is calculated. The difference between the original inside diameter and the new one resulting from bearing swell is charted as the required diametrical allowance for swell.

The amount of volume change of a bearing is, of course, determined by the wall thickness of the bearing layer(s). It is recognized that the bearing will not exhibit all swell in an inwards radial direction, and that because of restraints caused by press-fitting, etc., the swell will not be quite as much as determined here. The following charts showing the diametrical clearance required for swell are believed to represent a conservative determination of required allowance for swell.

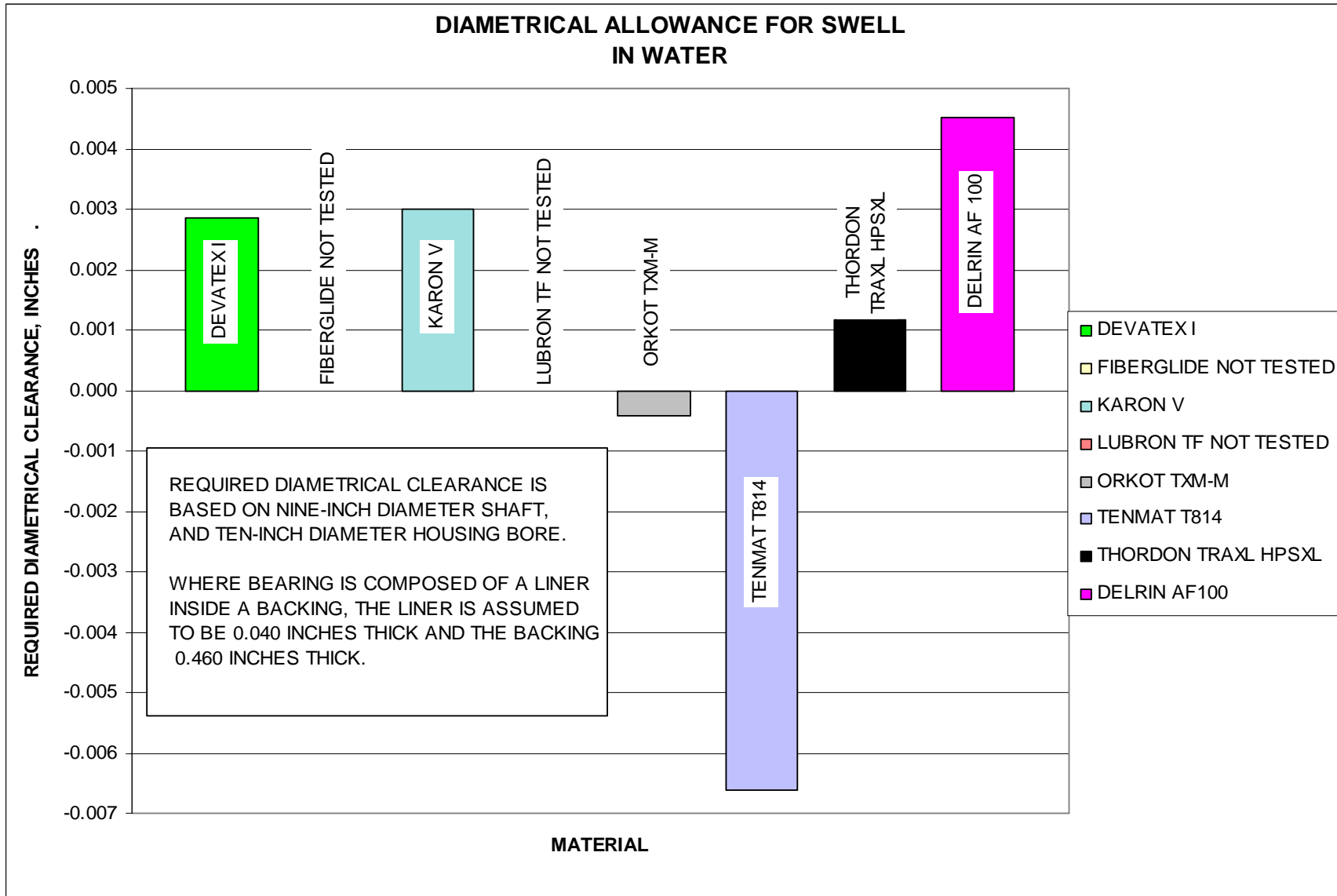

Figure E1. Diametrical allowance for swell in water.

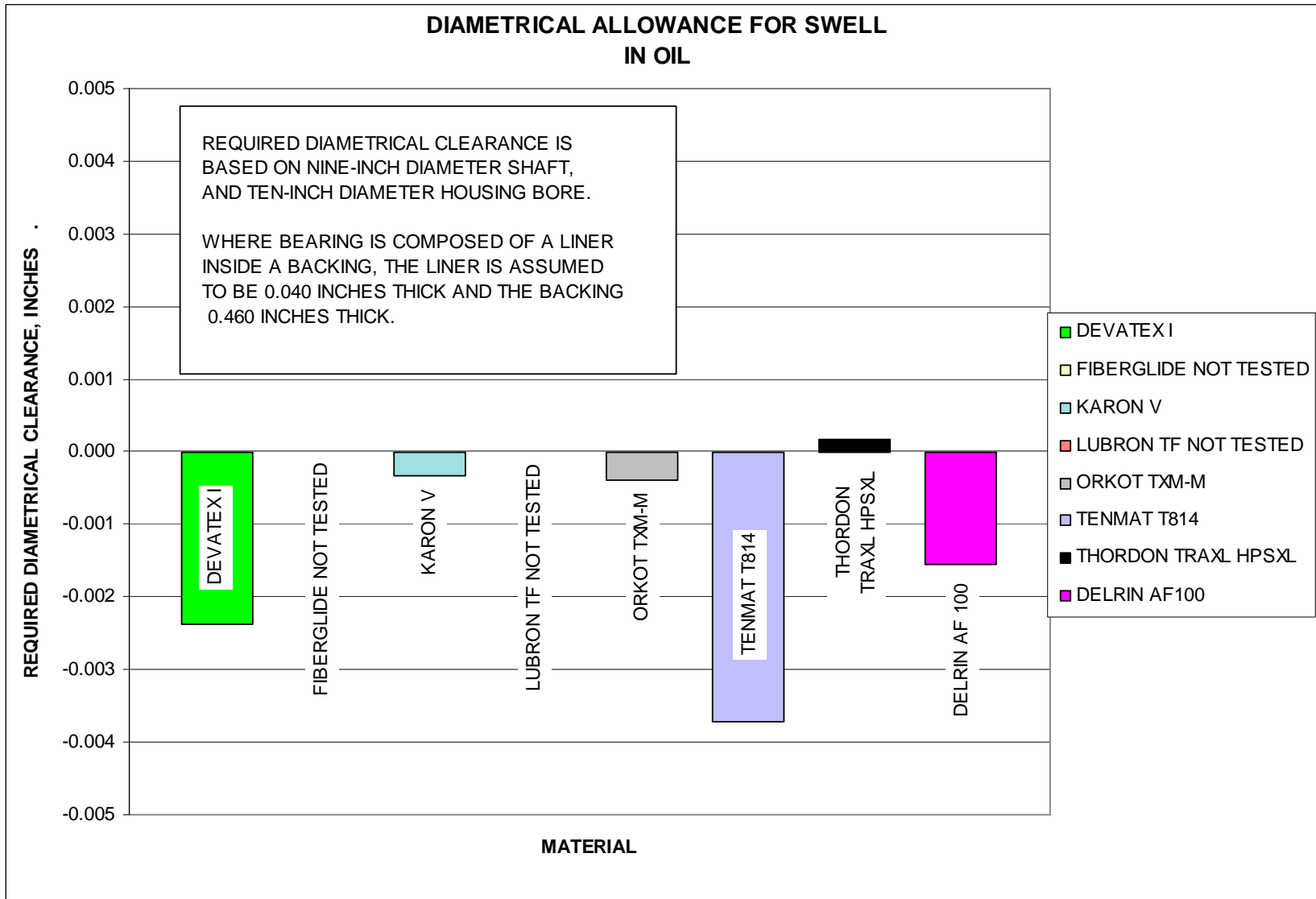

Figure E2. Diametrical allowance for swell in oil.

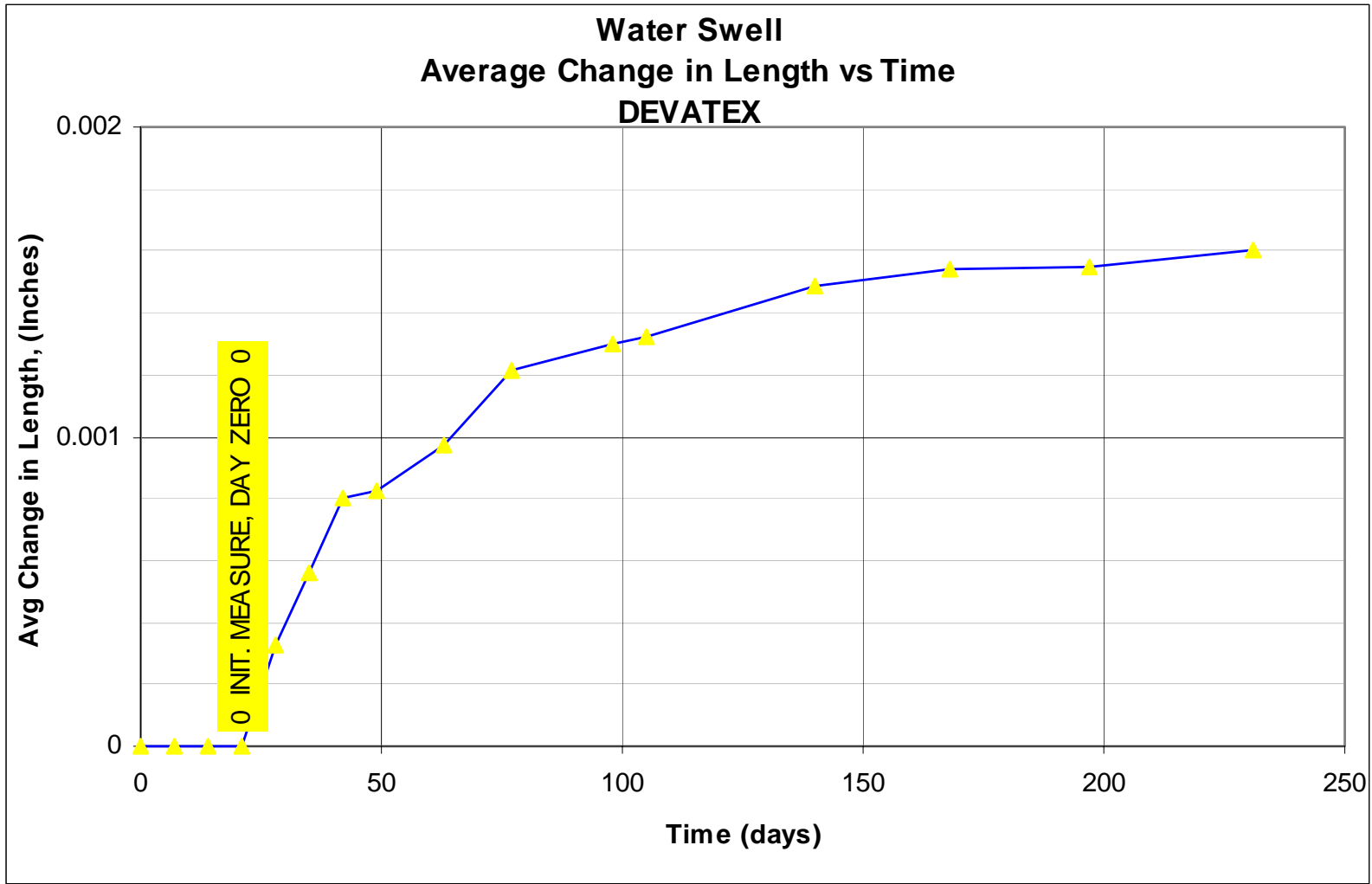

Figure E3. Average change in water swell length vs time using Devatex.

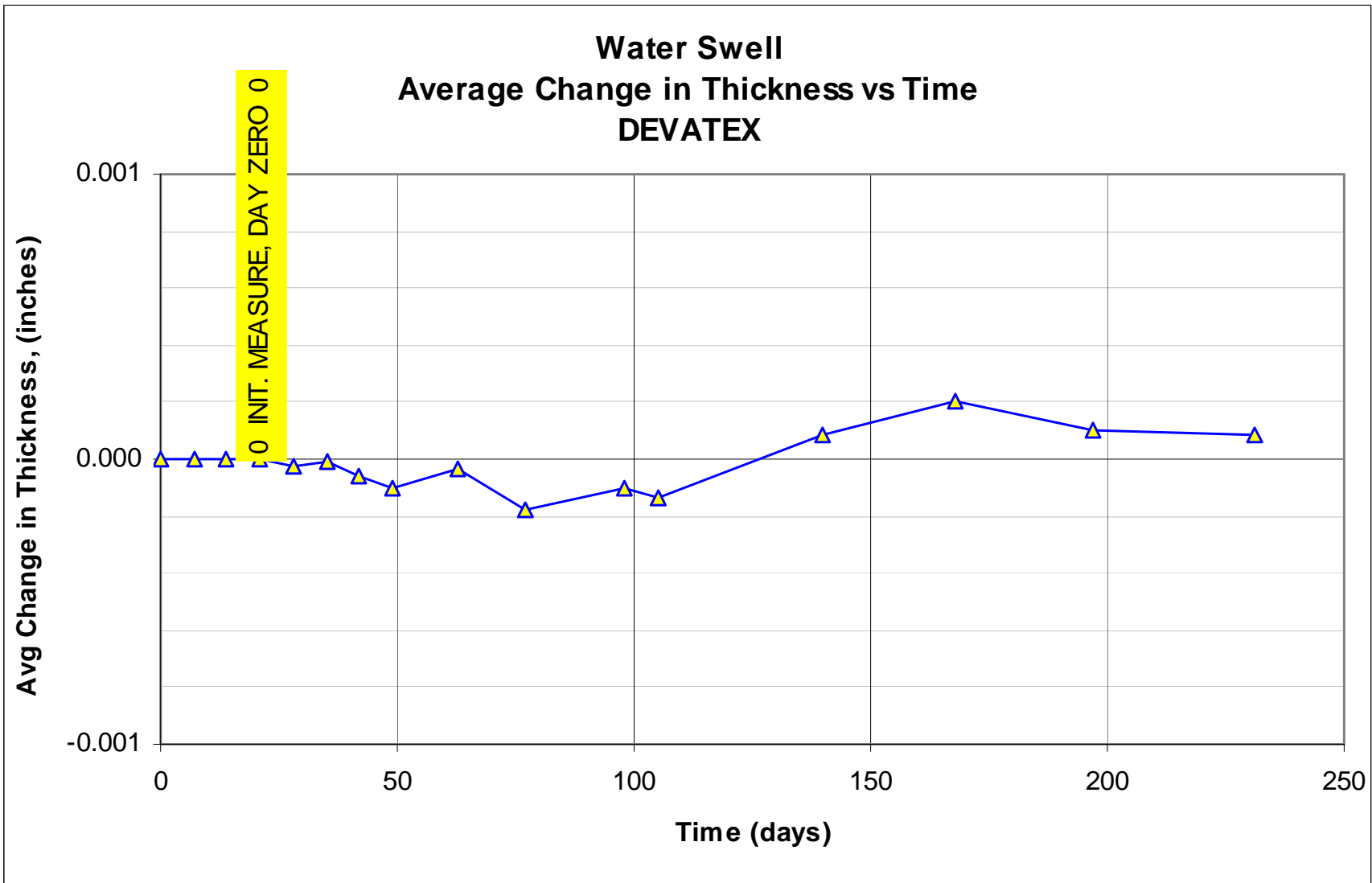

Figure E4. Average change in water swell thickness vs time using Devatex.

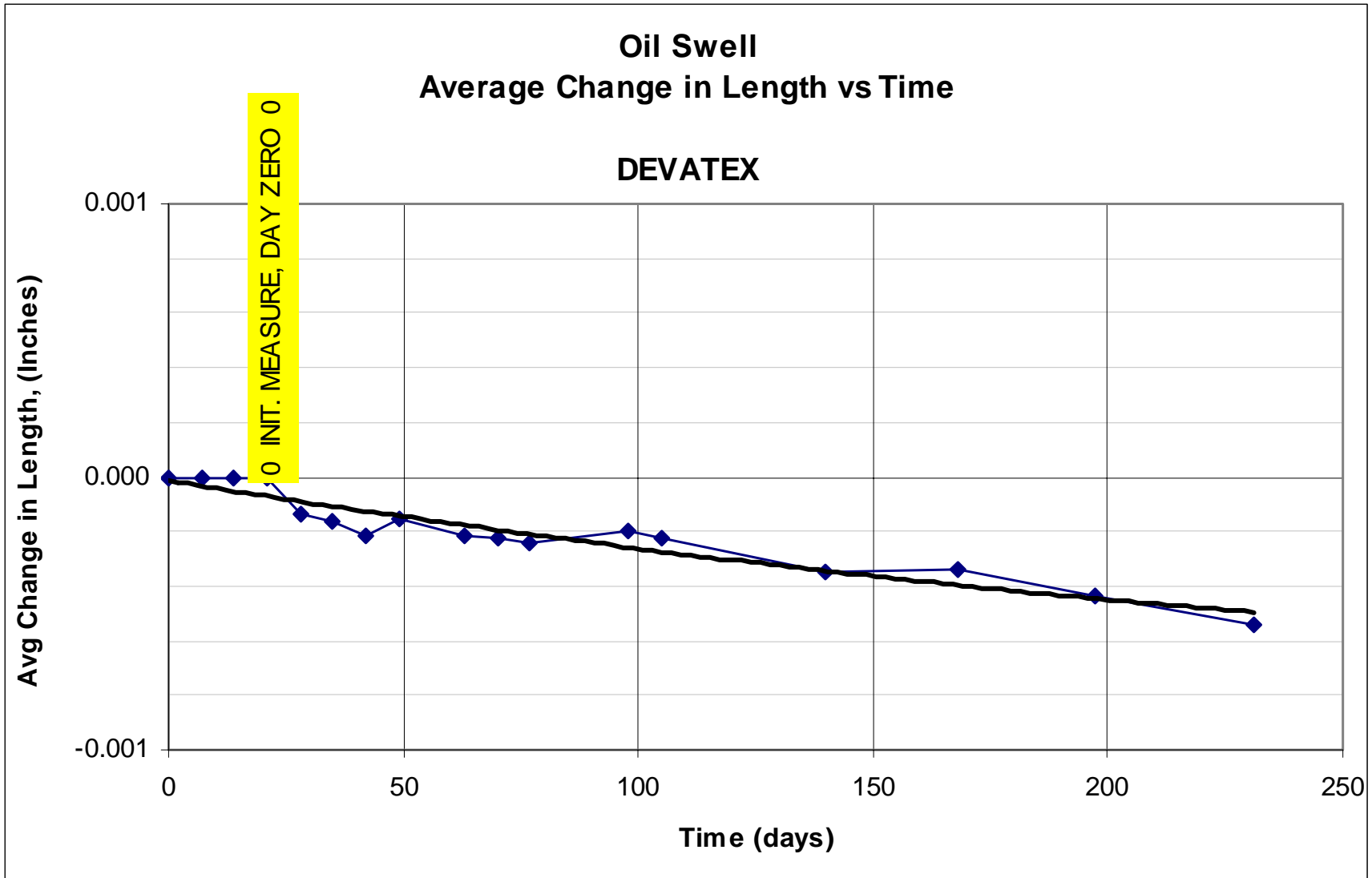

Figure E5. Average change in oil swell length vs time using Devatex.

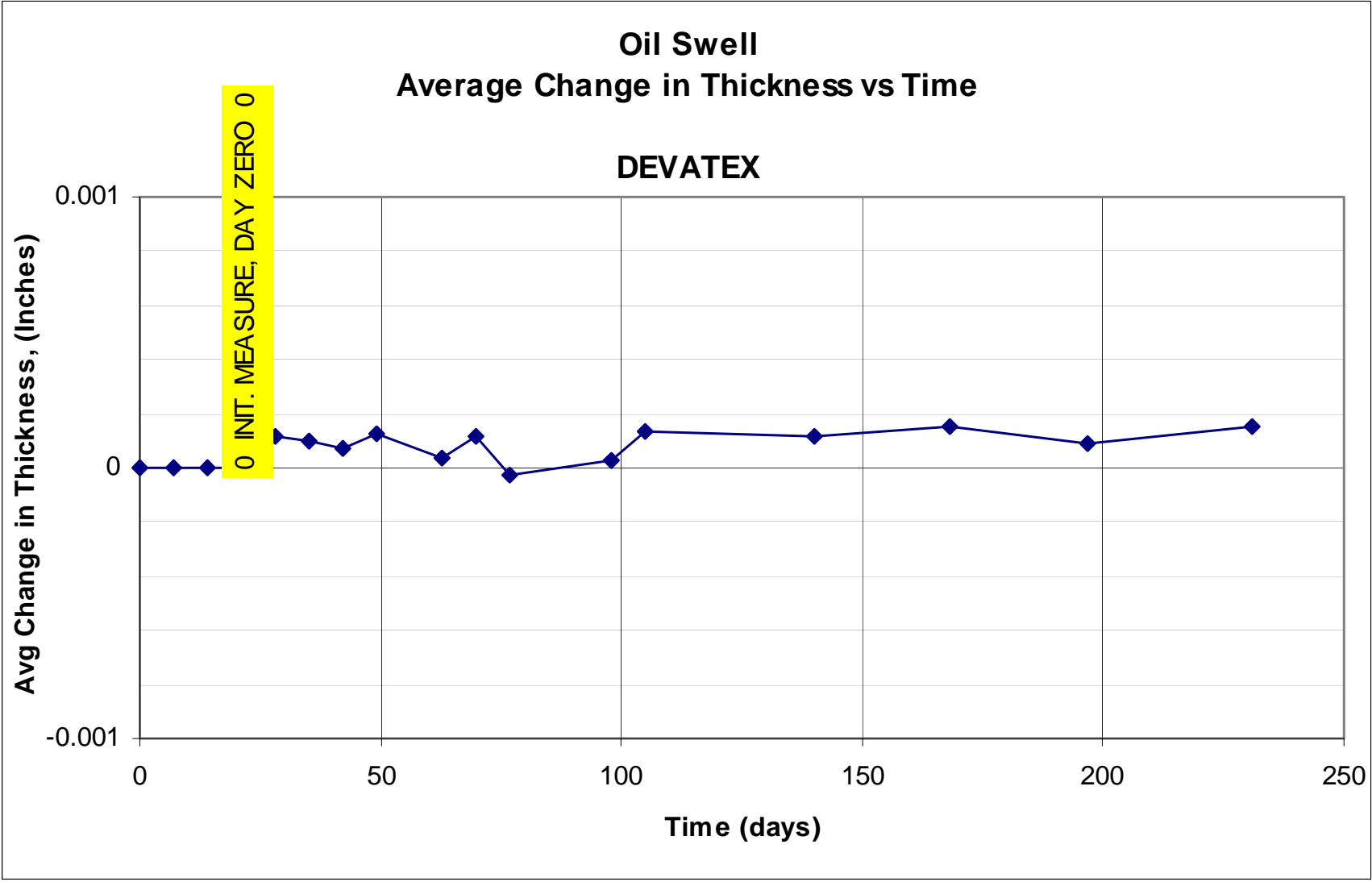

Figure E6. Average change in oil swell thickness vs time using Devatex.

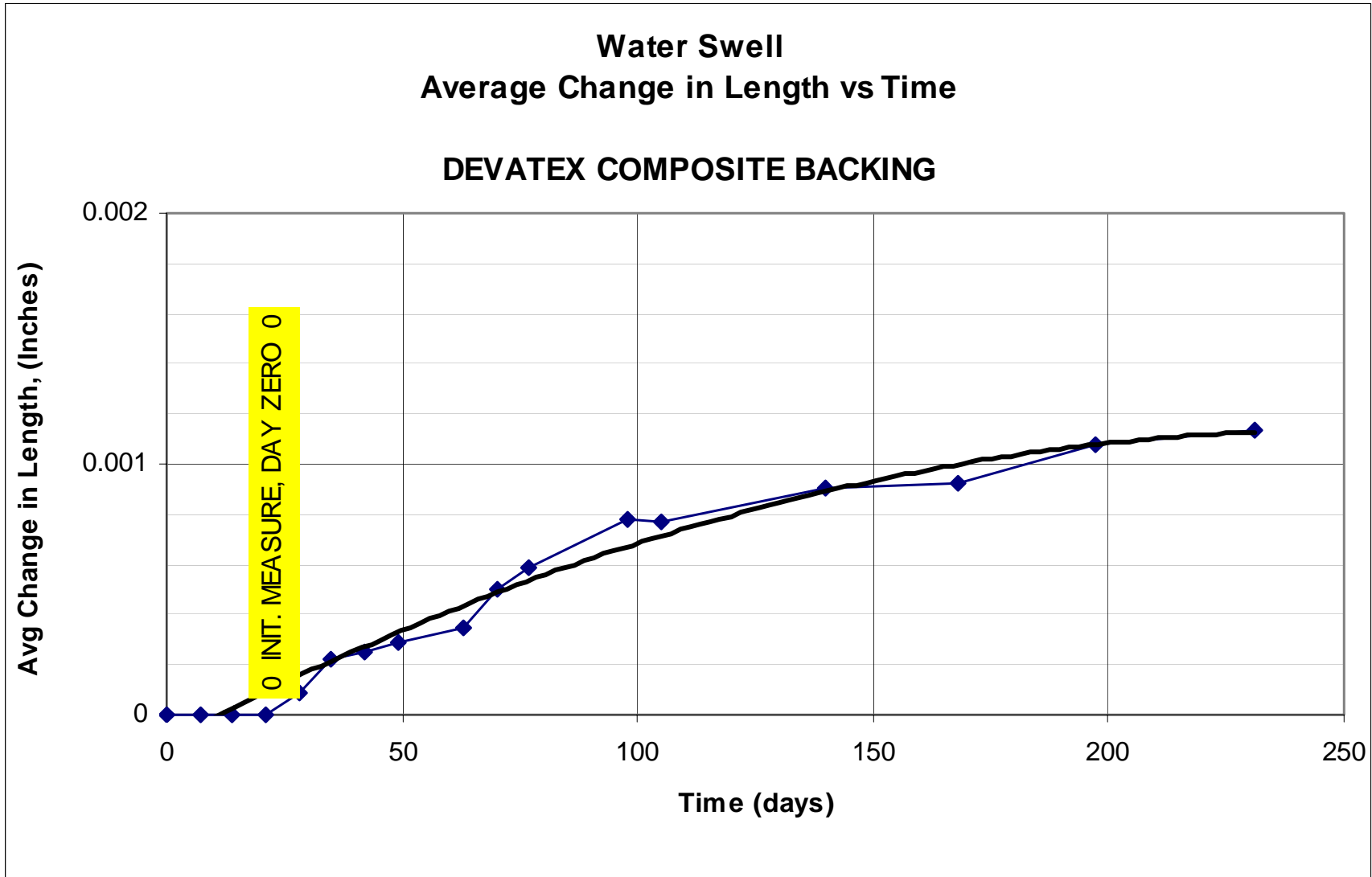

Figure E7. Average change in water swell length vs time using a Devatex composite backing.

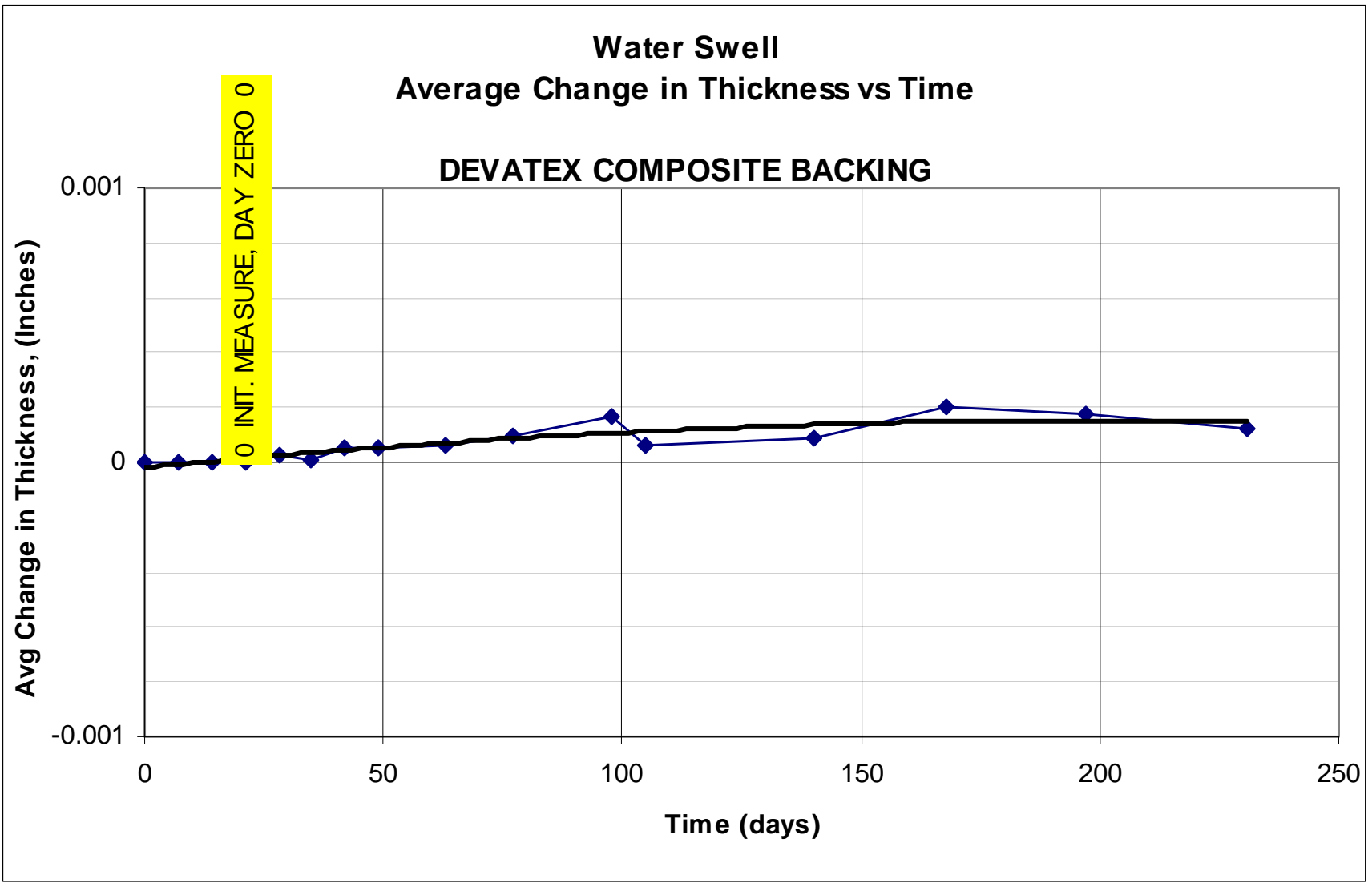

Figure E8. Average change in water swell thickness vs time using a Devatex composite backing.

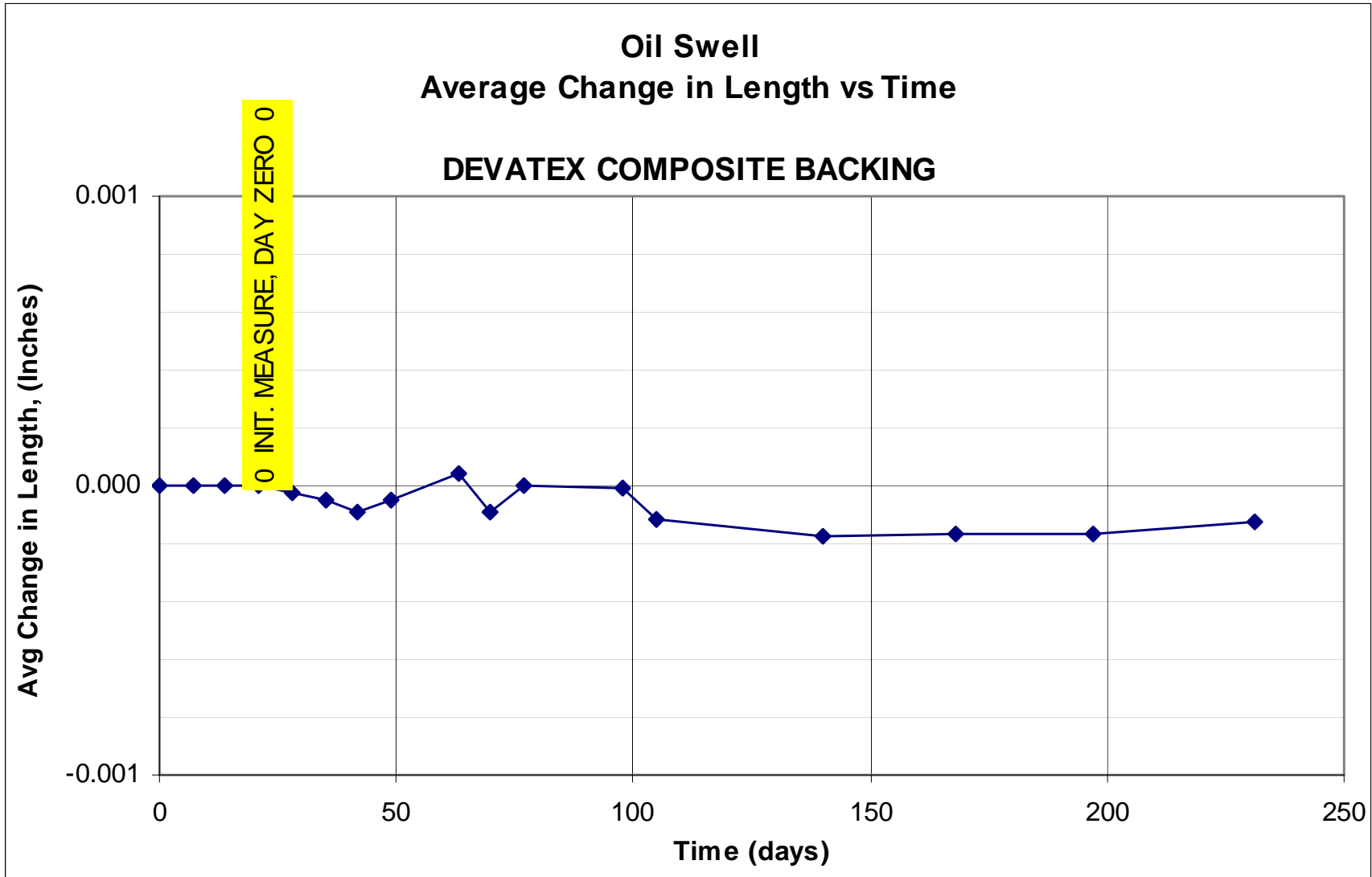

Figure E9. Average change in oil swell length vs time using a Devatex composite backing.

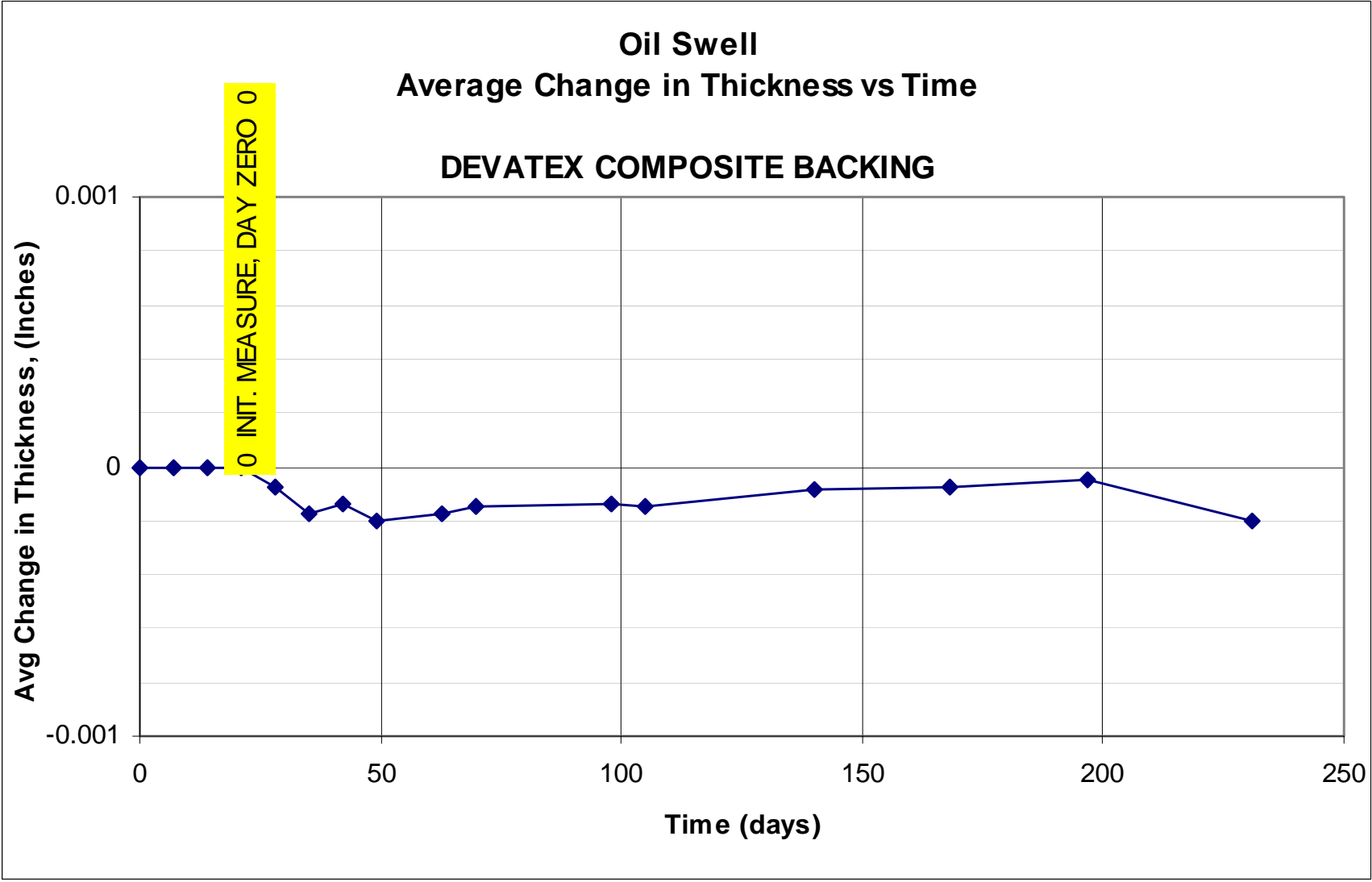

Figure E10. Average change in oil swell thickness vs time using a Devatex composite backing.

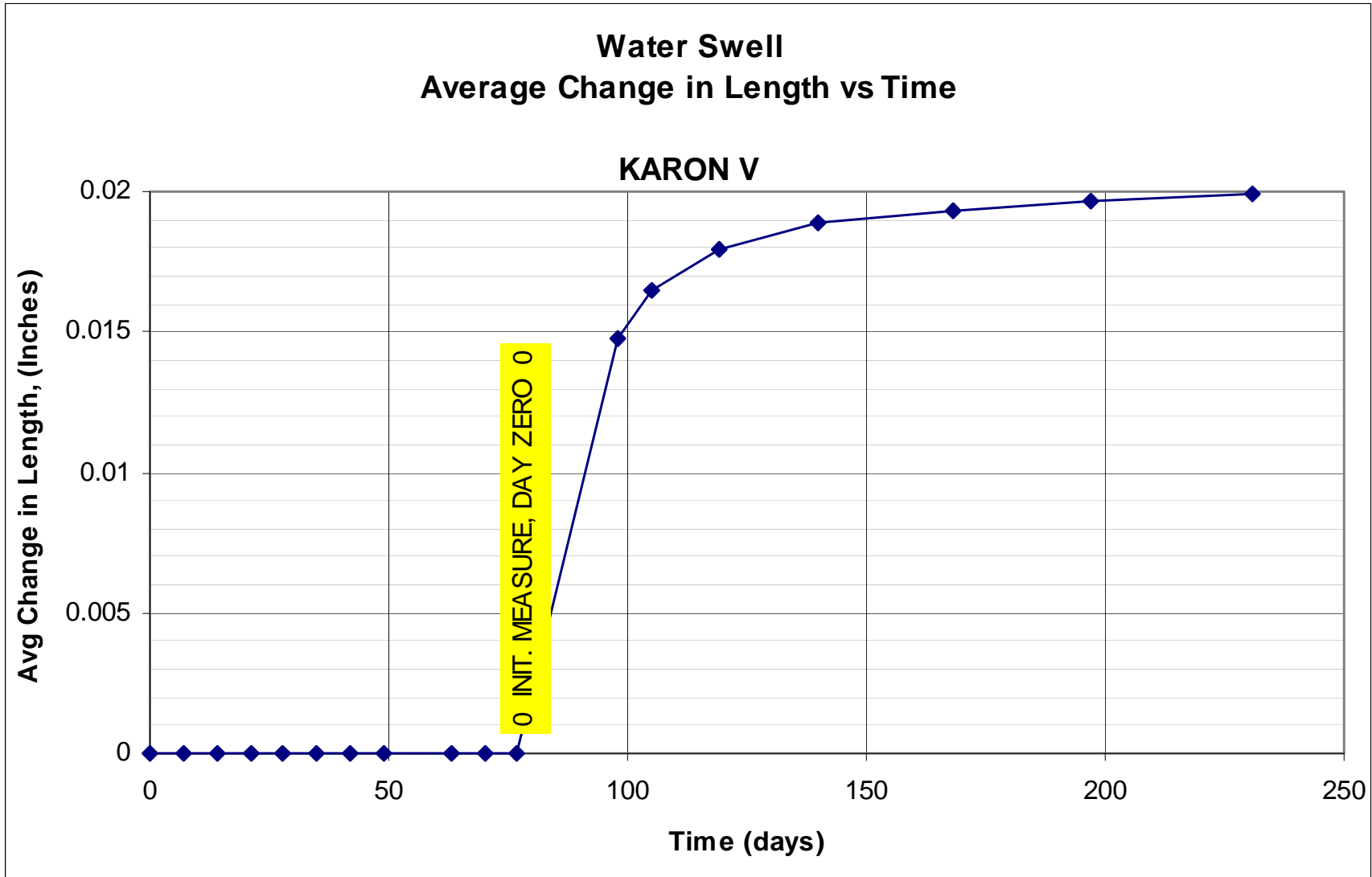

Figure E11. Average change in water swell length vs time using Karon V.

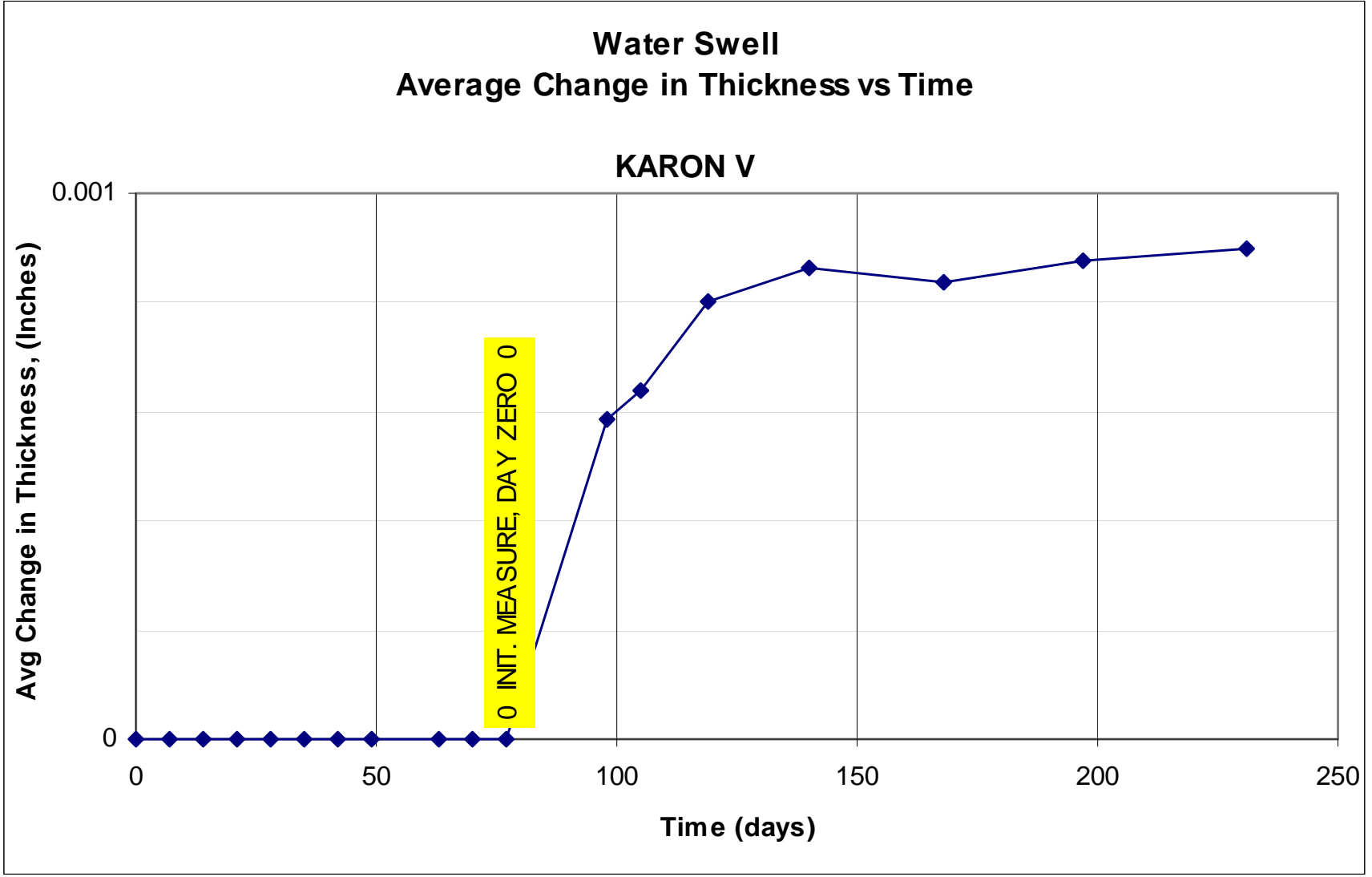

Figure E12. Average change in water swell thickness vs time using Karon V.

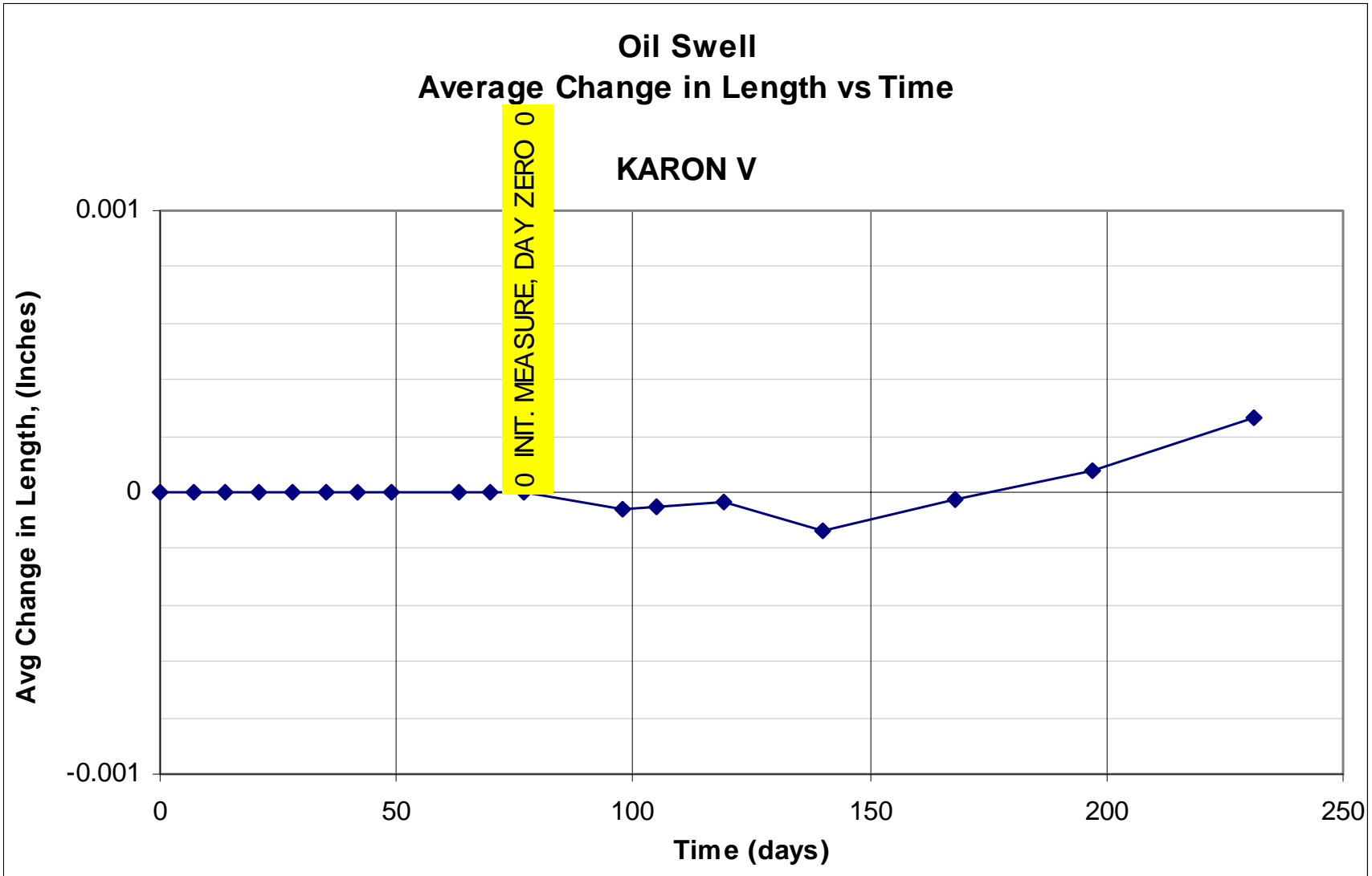

Figure E13. Average change in oil swell length vs time using Karon V.

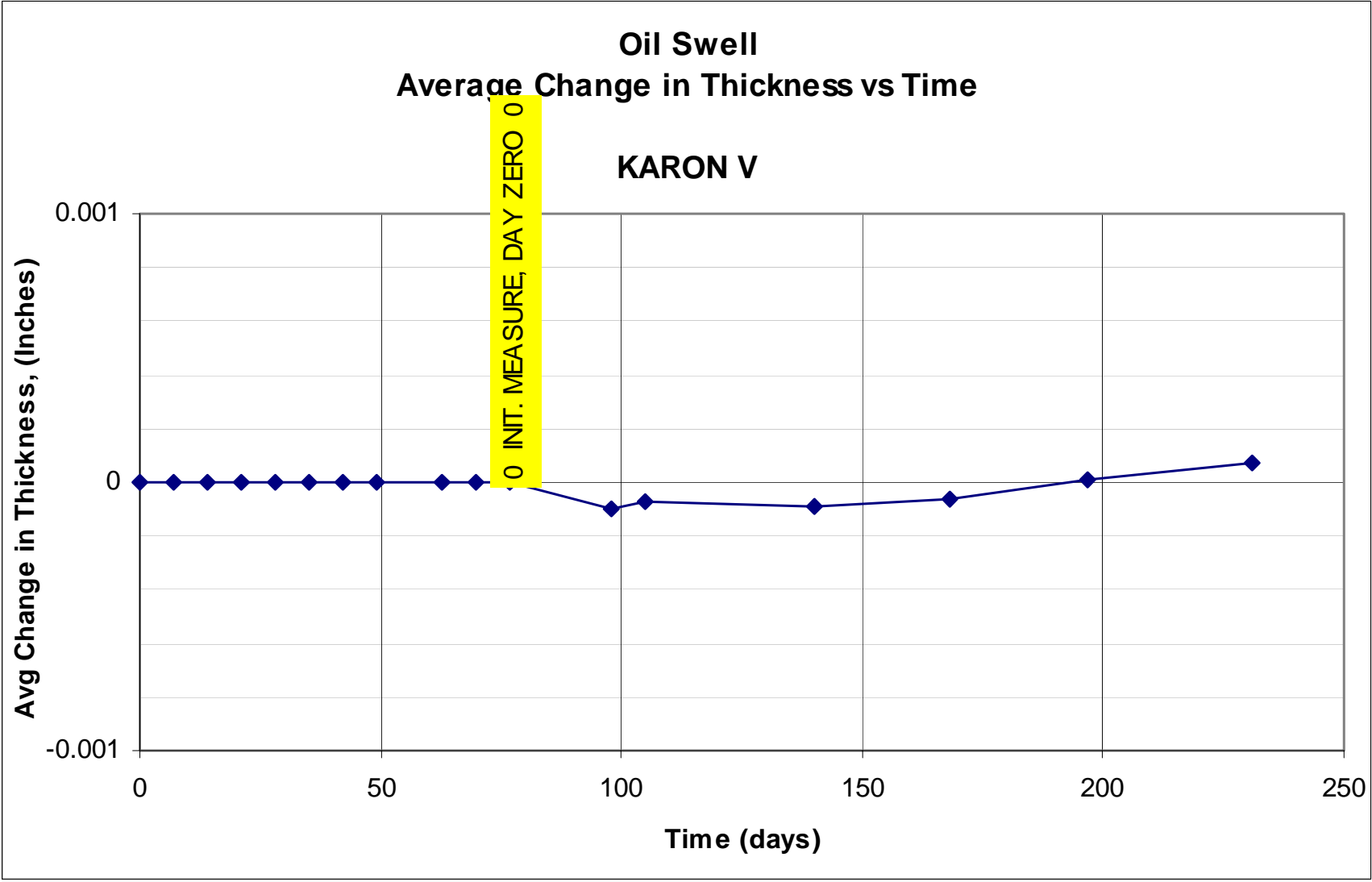

Figure E14. Average change in oil swell thickness vs time using Karon V.

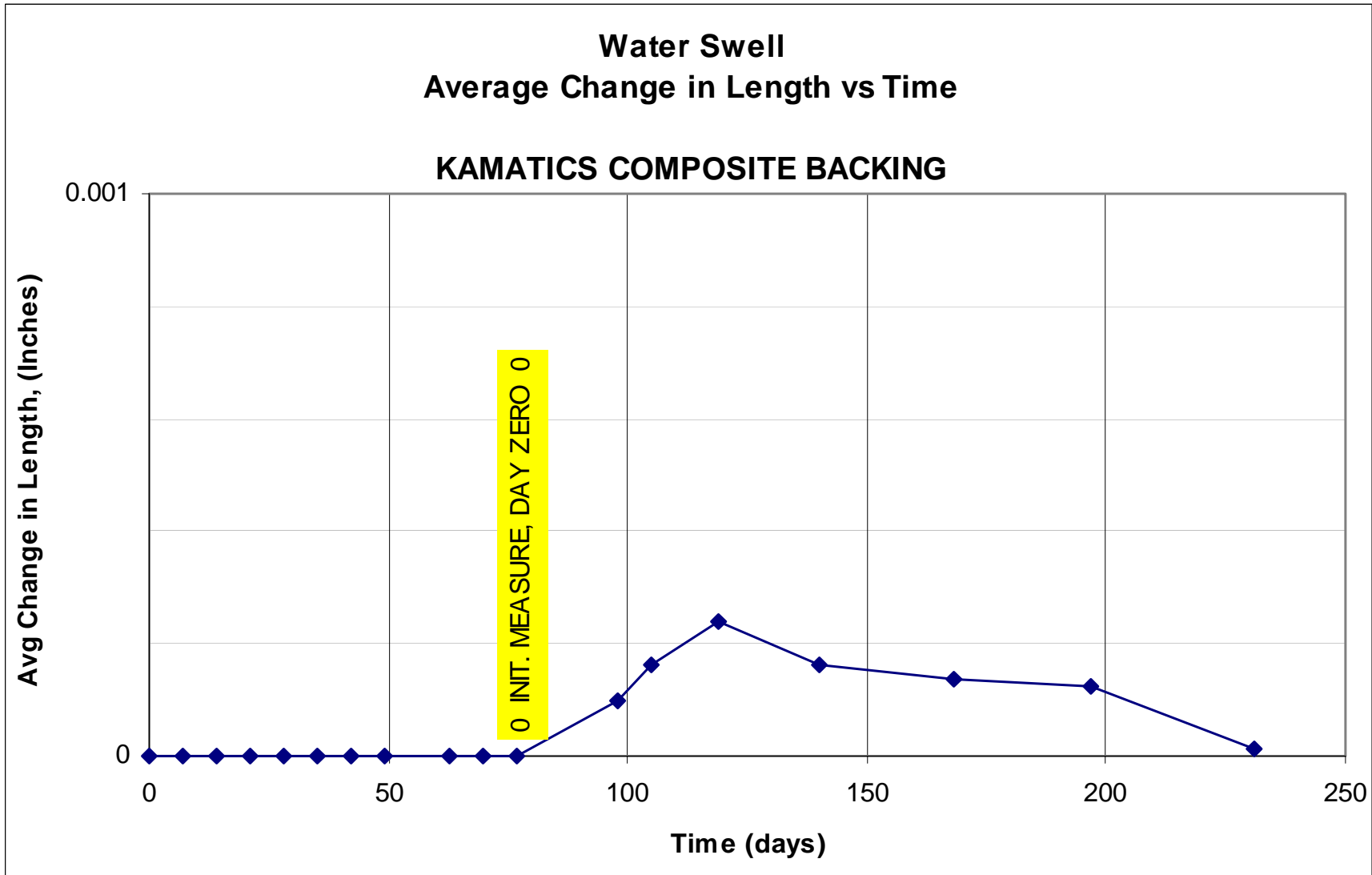

Figure E15. Average change in water swell length vs time using a Kamatics composite backing.

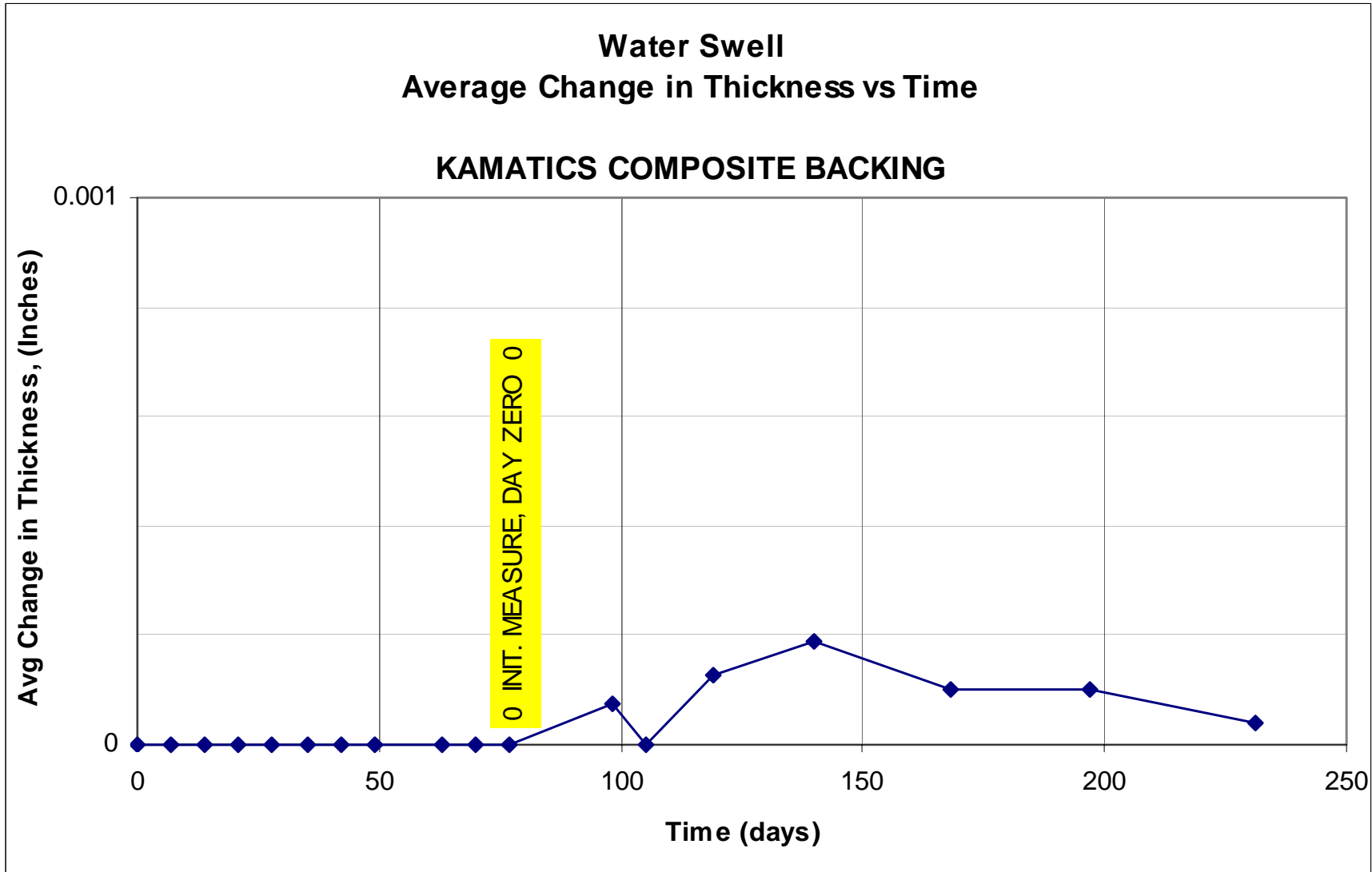

Figure E16. Average change in water swell thickness vs time using a Kamatics composite backing.

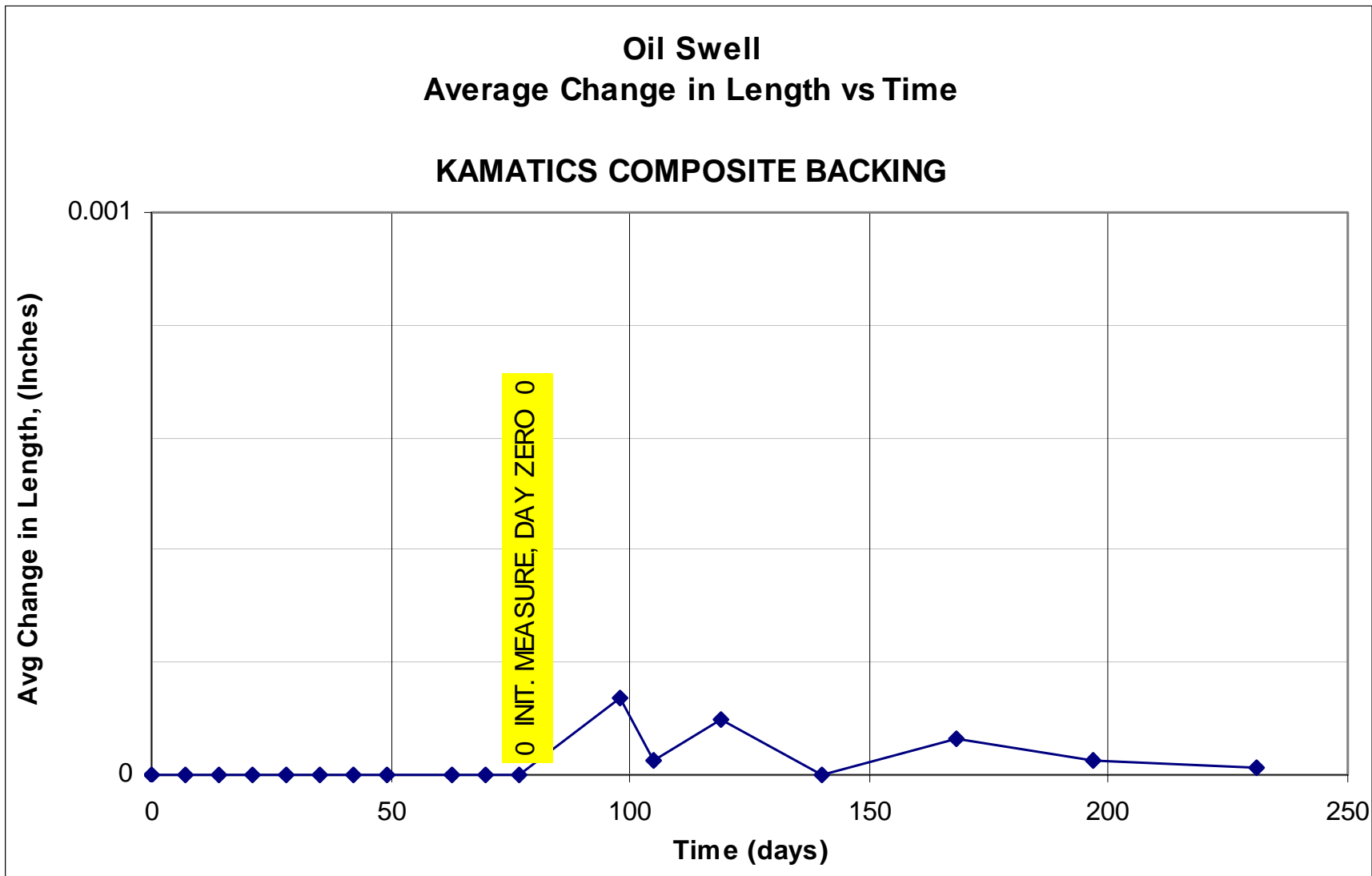

Figure E17. Average change in oil swell length vs time using a Kamatics composite backing.

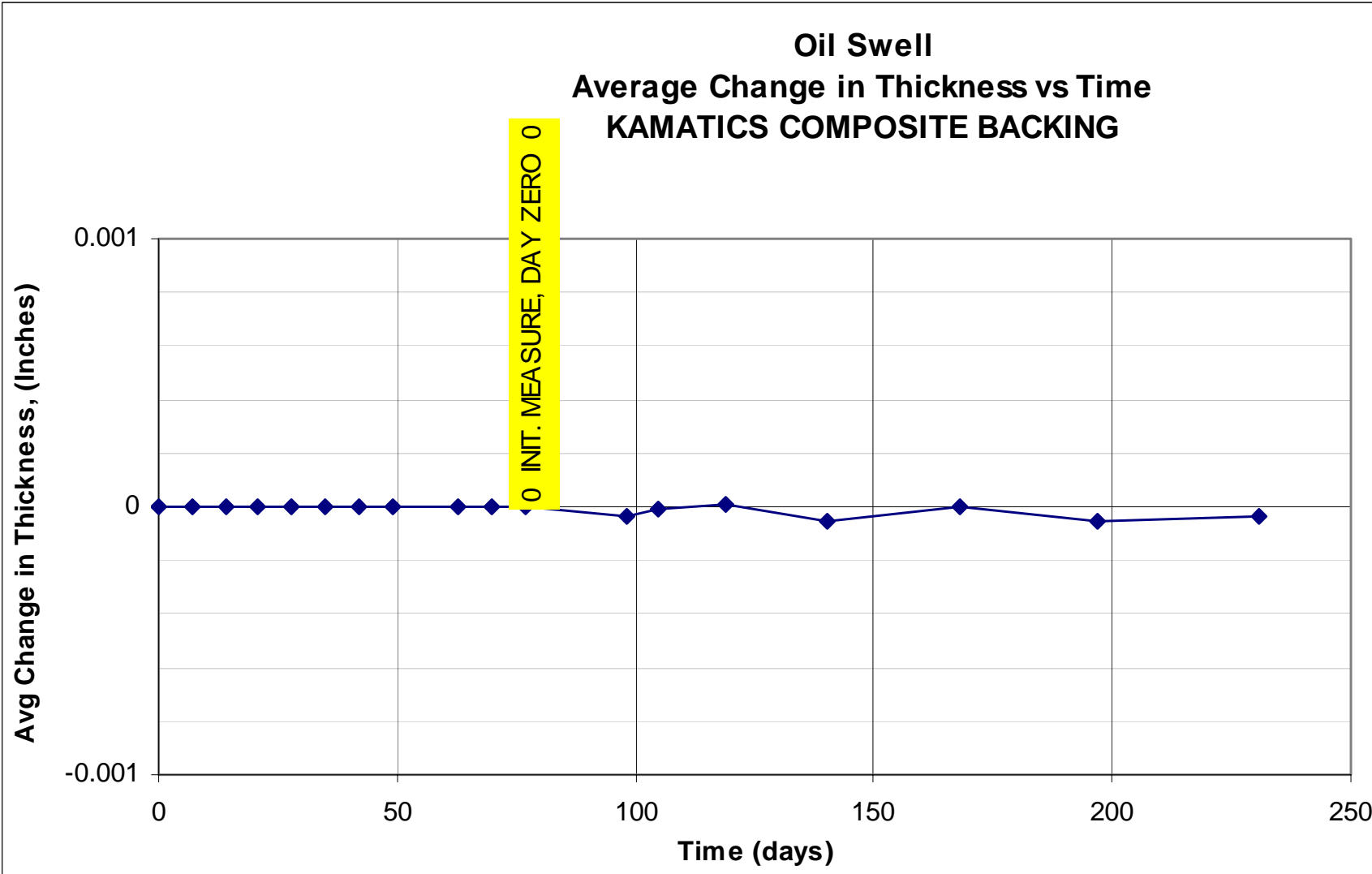

Figure E18. Average change in oil swell thickness vs time using a Kamatics composite backing.

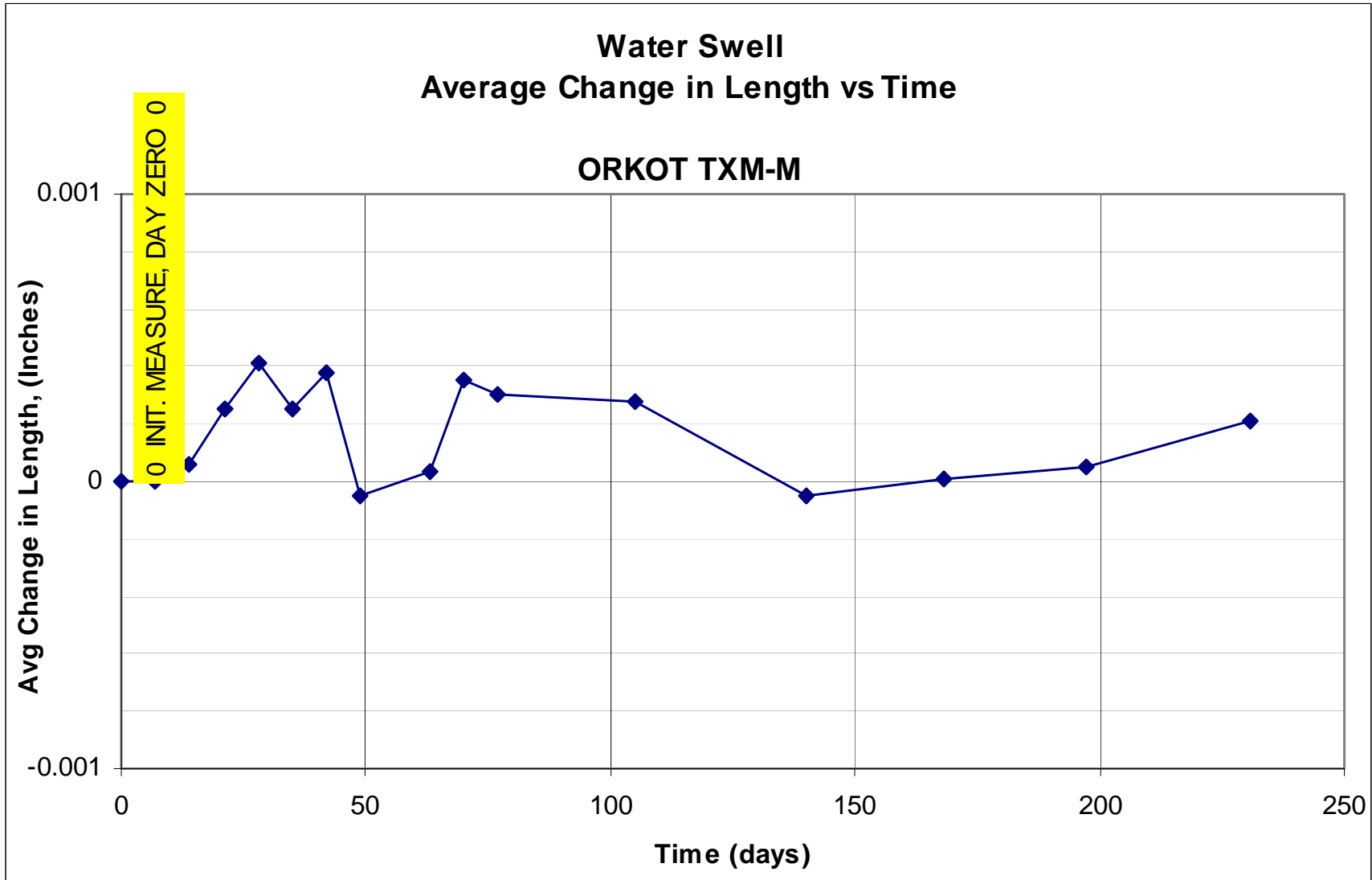

Figure E19. Average change in water swell length vs time using Orkot TXM-M.

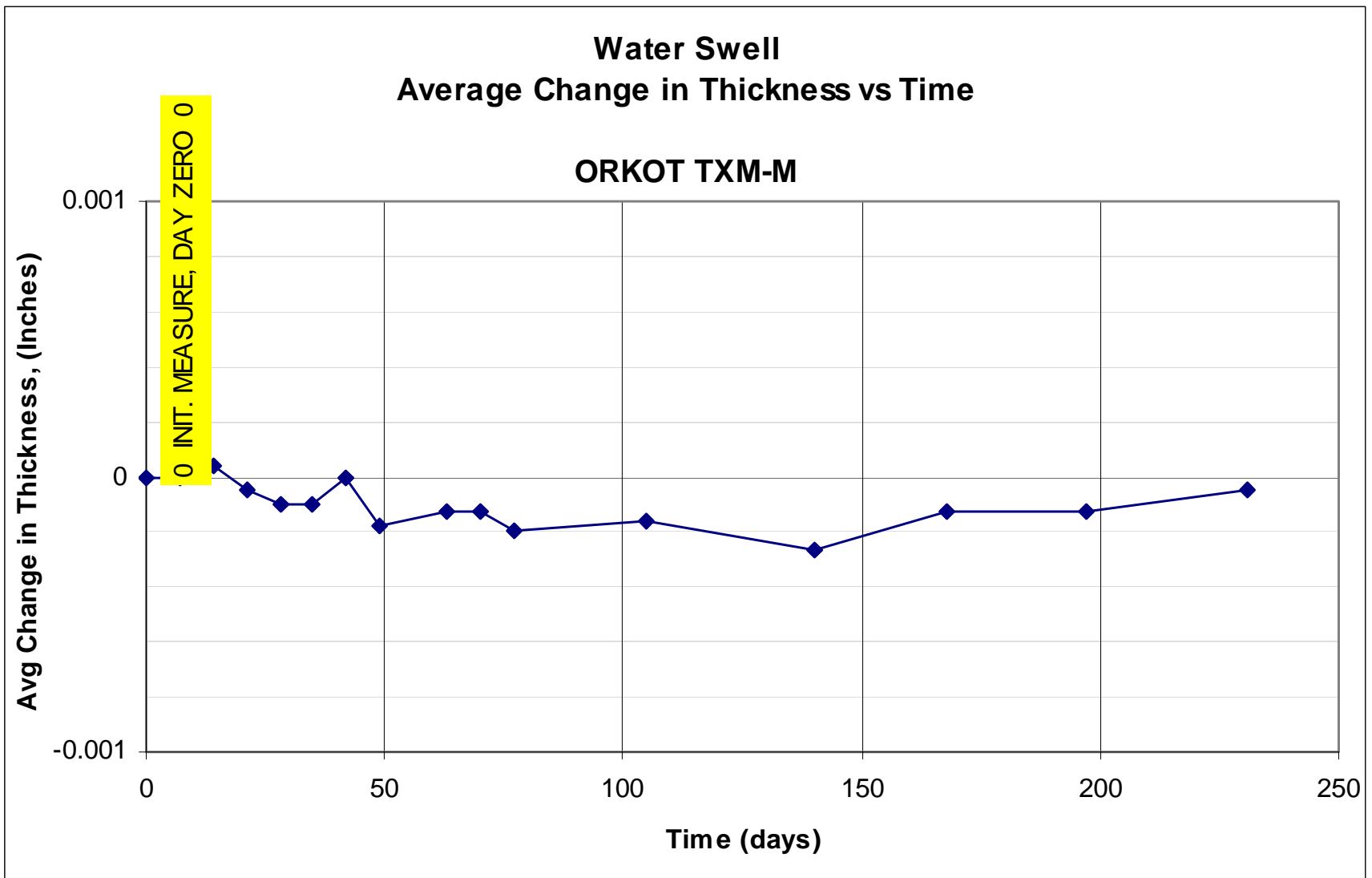

Figure E20. Average change in water swell thickness vs time using Orkot TXM-M.

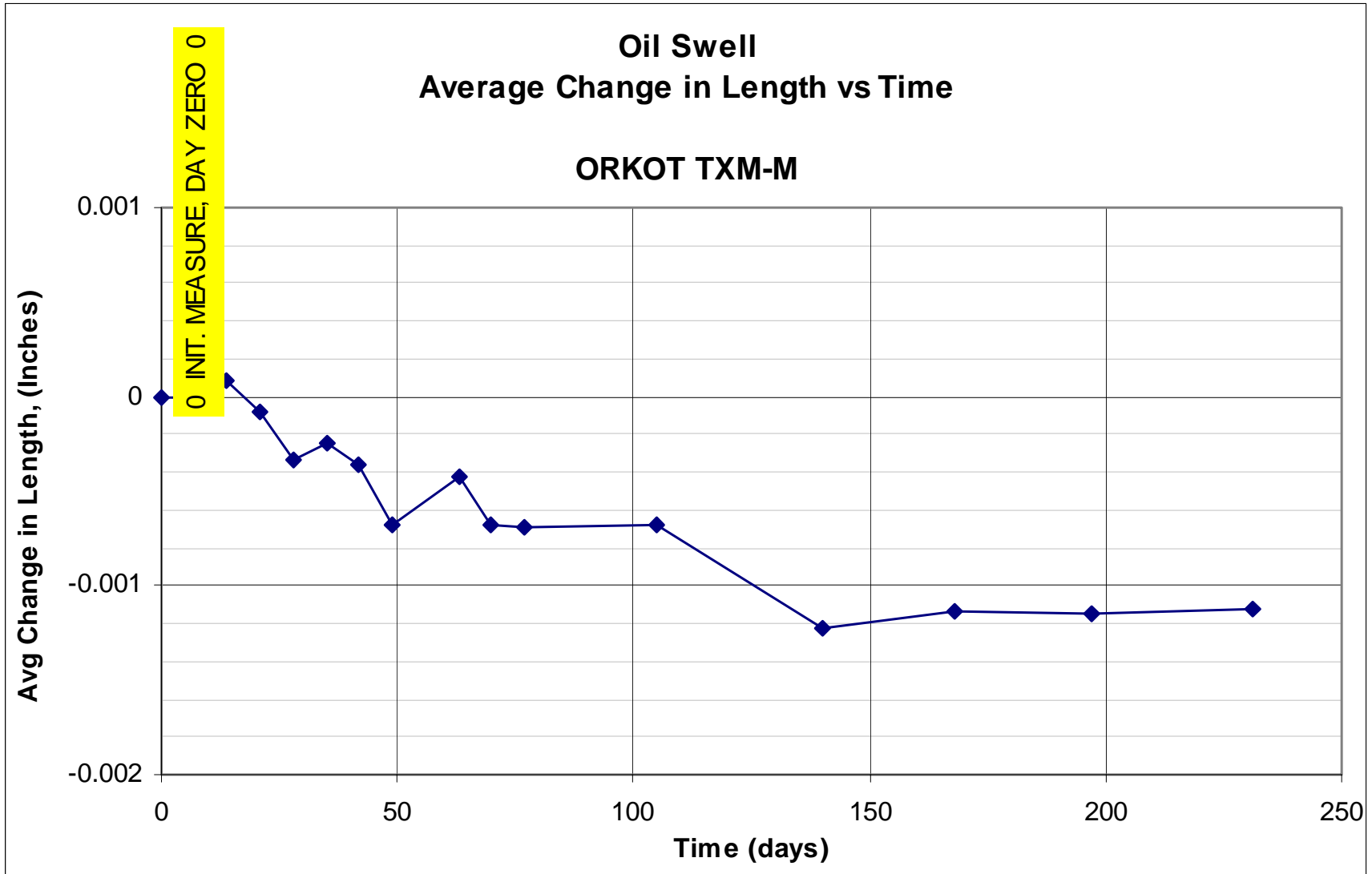

Figure E21. Average change in oil swell length vs time using Orkot TXM-M.

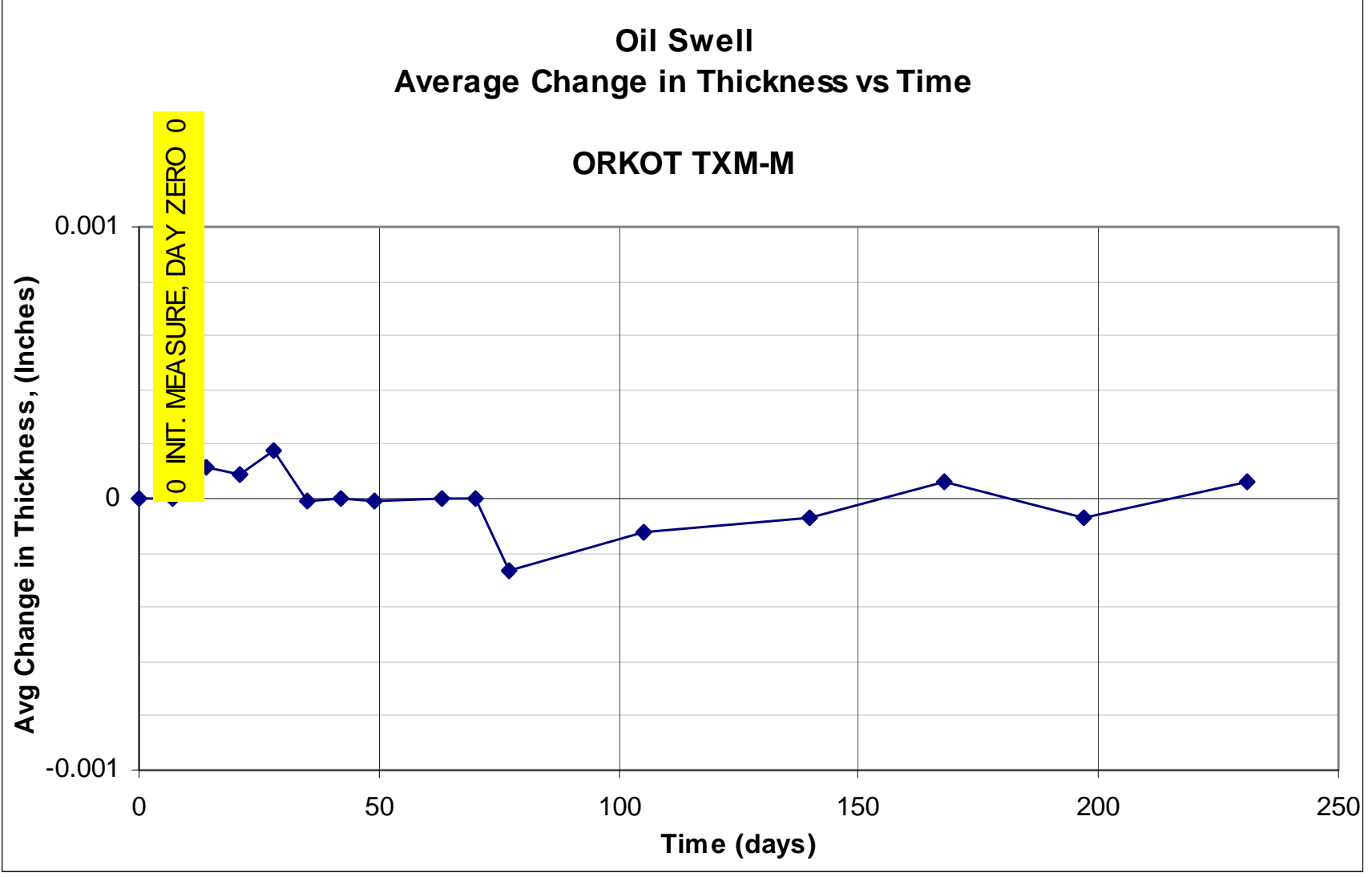

Figure E22. Average change in oil swell thickness vs time using OrkotTXM-M.

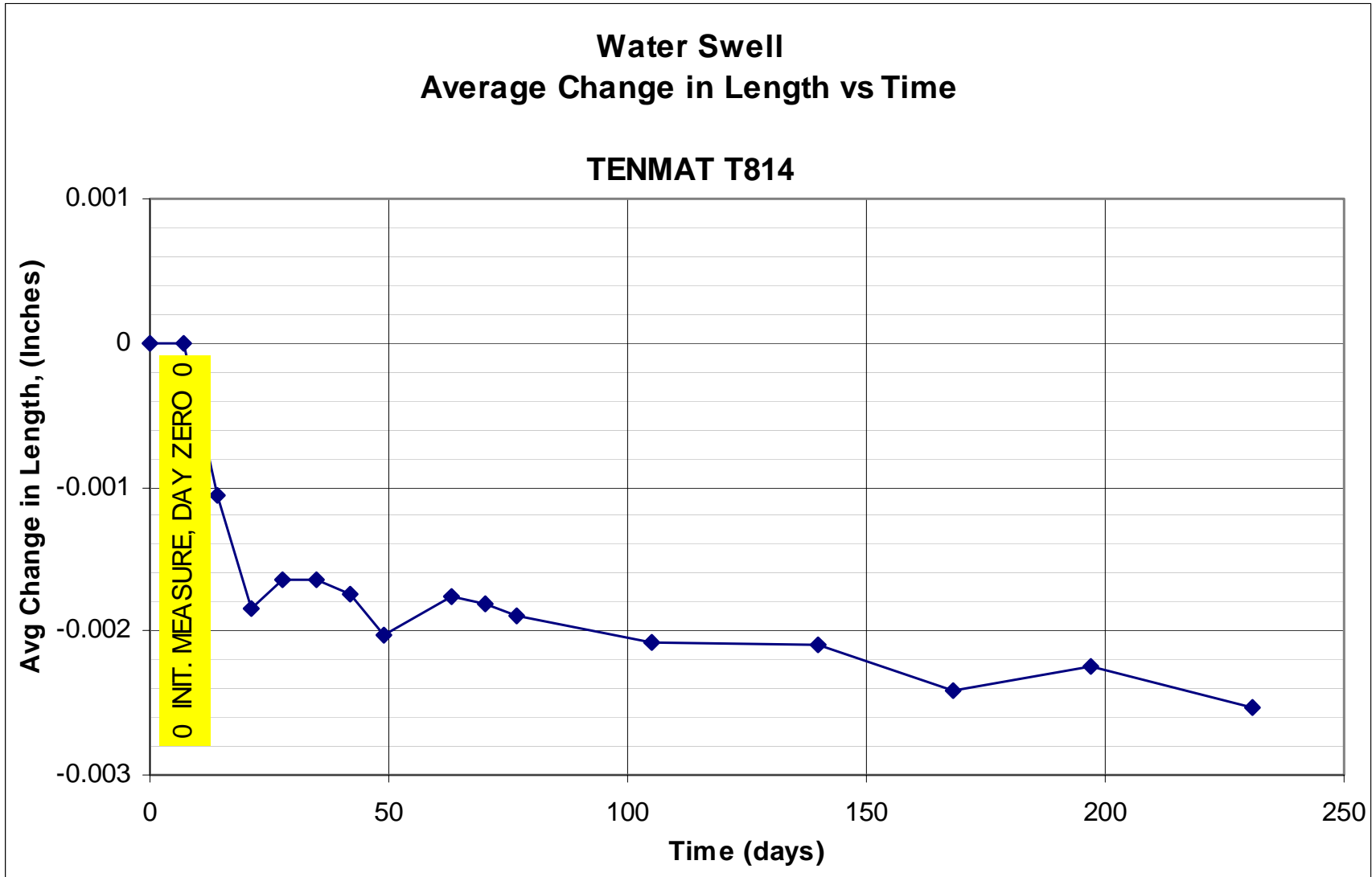

Figure E23. Average change in water swell length vs time using Tenmat T814.

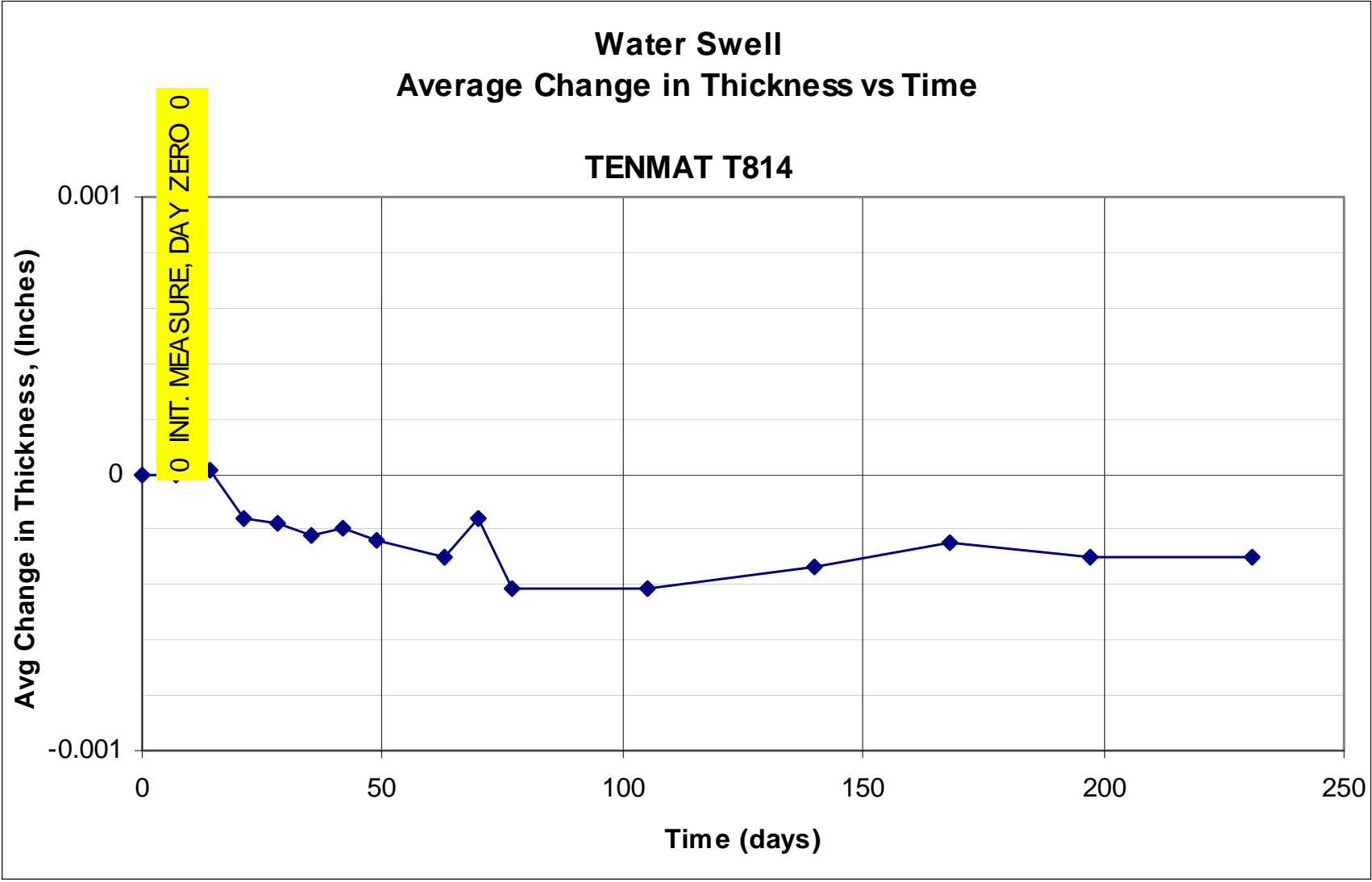

Figure E24. Average change in water swell thickness vs time using Tenmat T814.

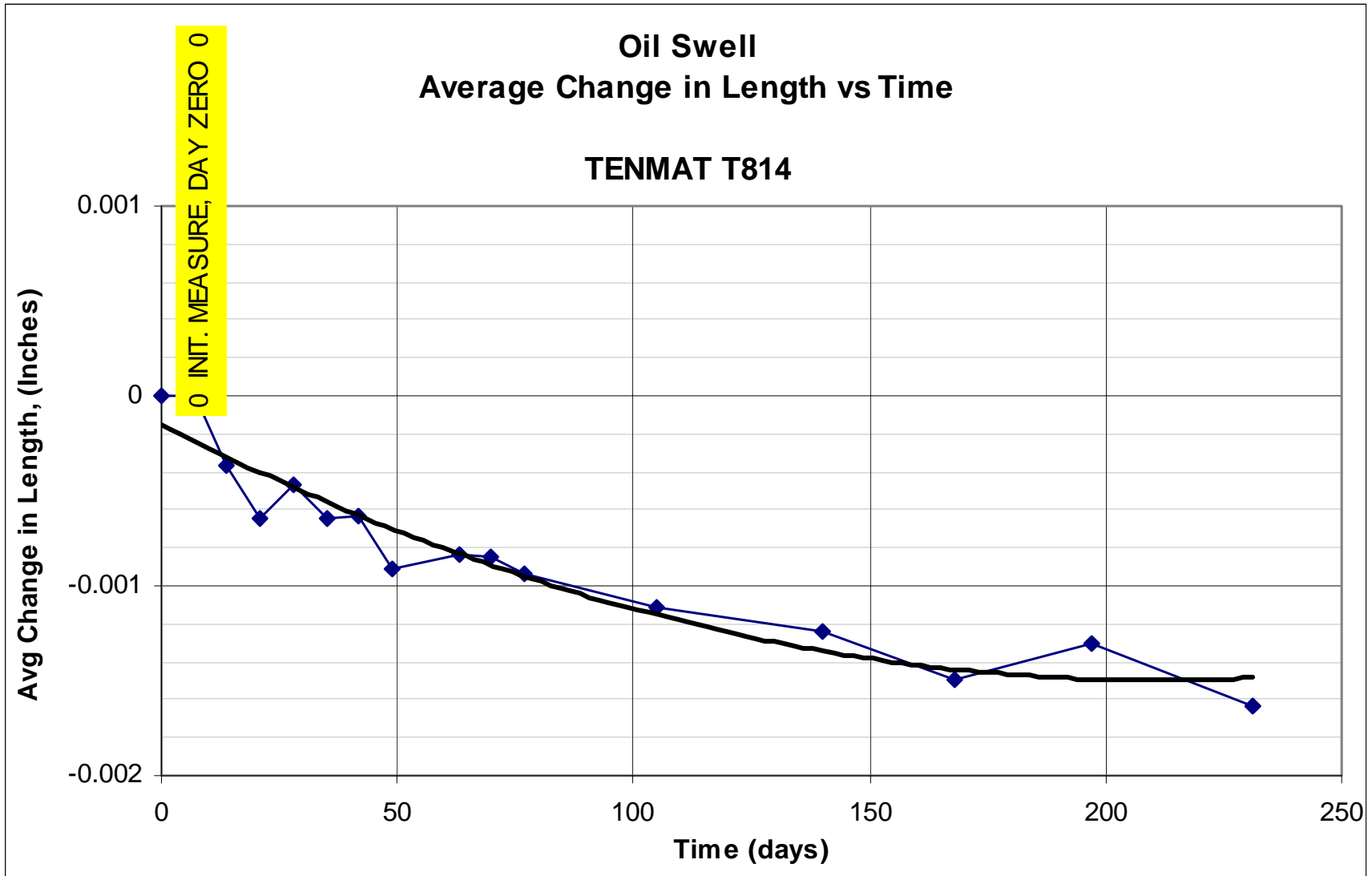

Figure E25. Average change in oil swell length vs time using Tenmat T814.

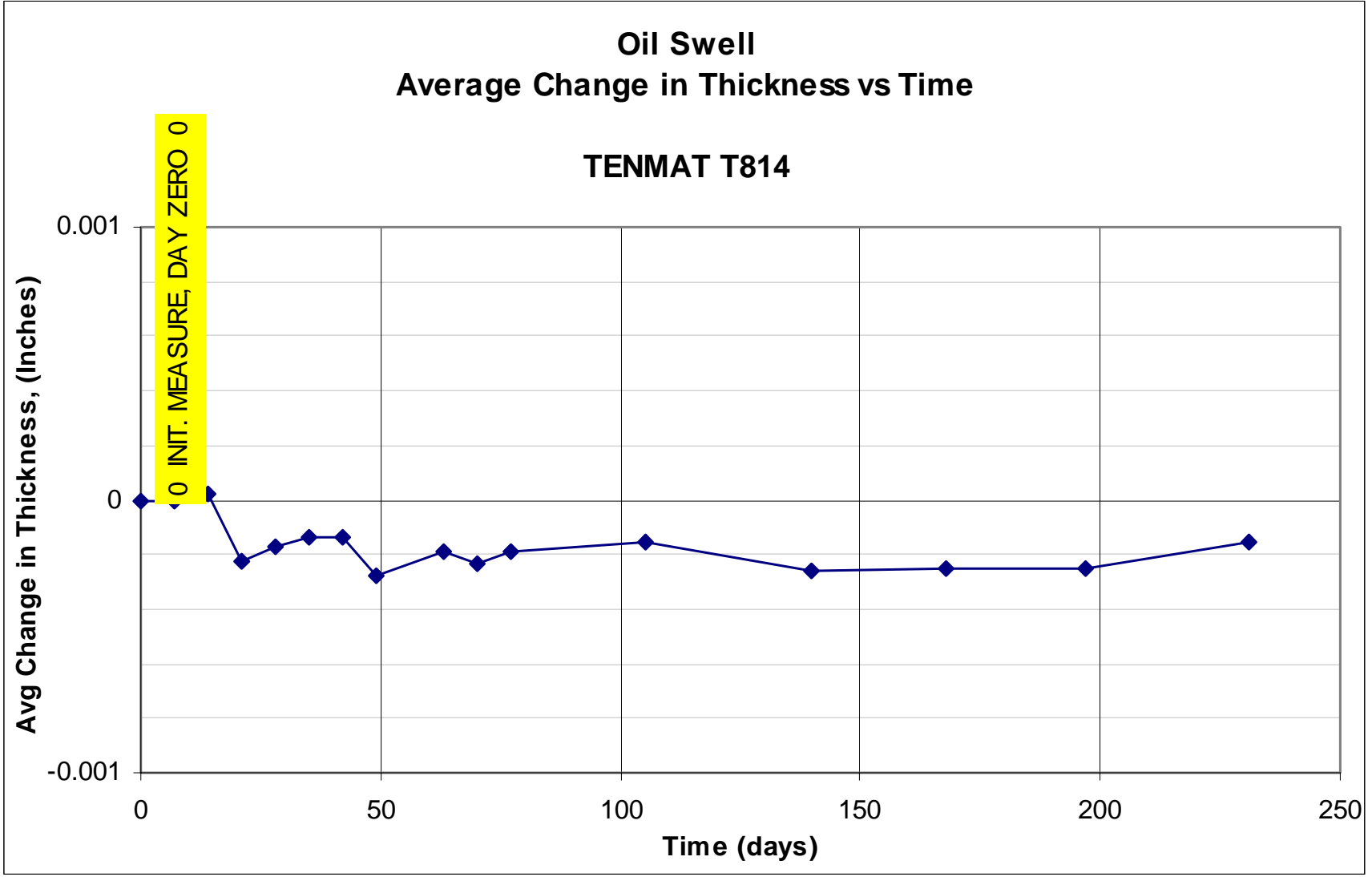

Figure E26. Average change in oil swell thickness vs time using Tenmat T814.

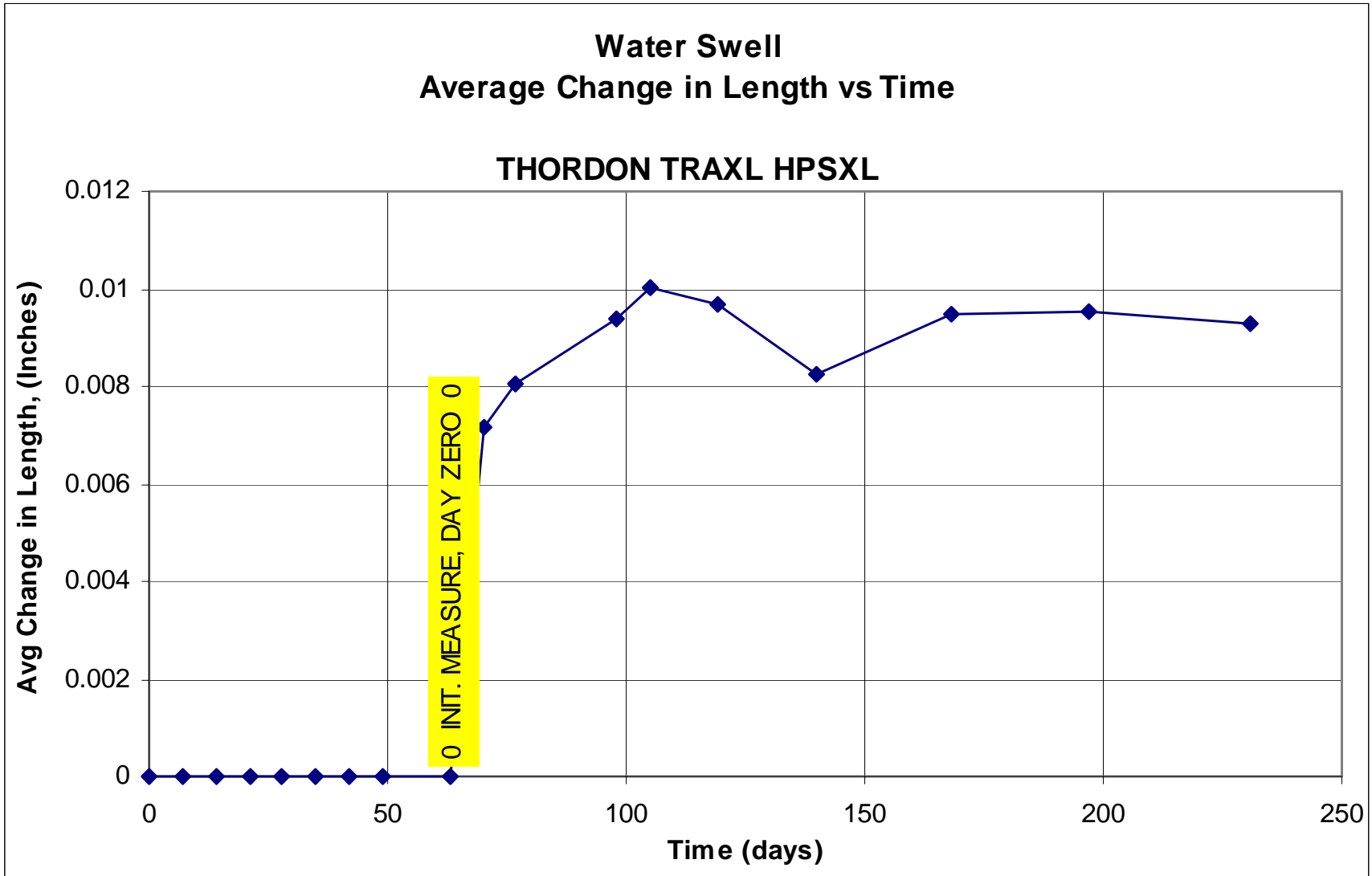

Figure E27. Average change in water swell length vs time using Thordon TRAXL HPSXL.

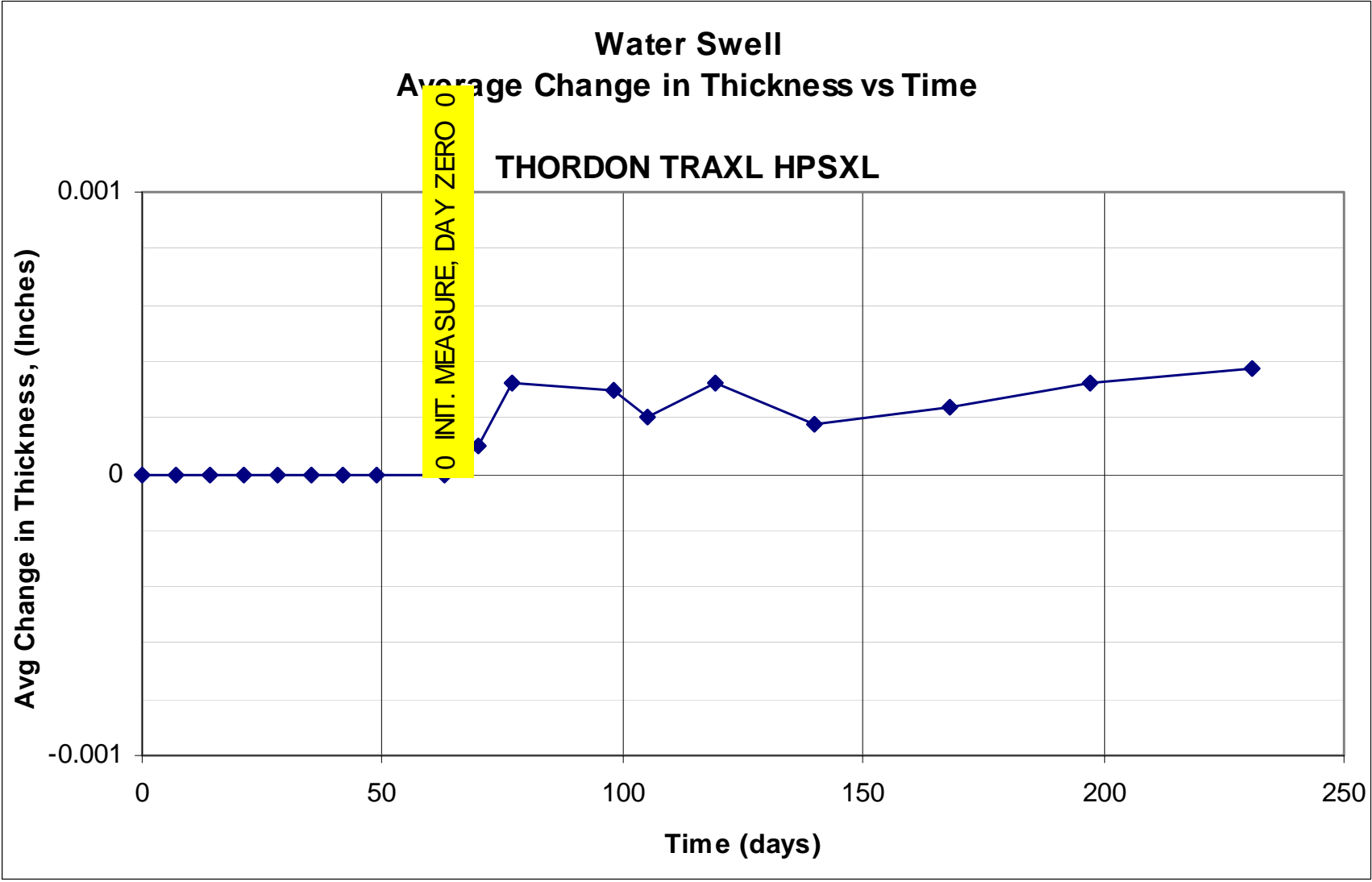

Figure E28. Average change in water swell thickness vs time using Thordon TRAXL HPSXL.

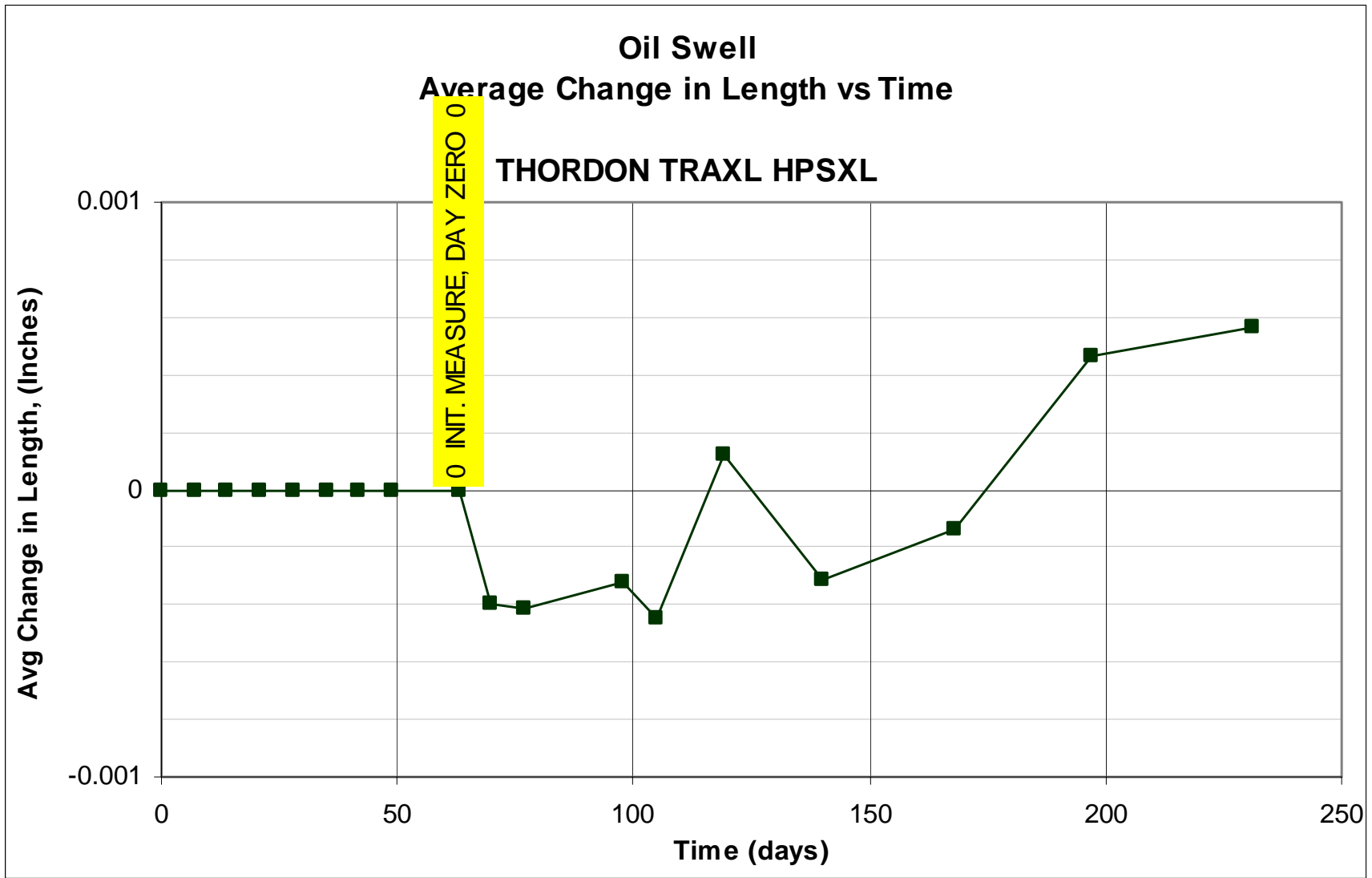

Figure E29. Average change in oil swell length vs time using Thordon TRAXL HPSXL.

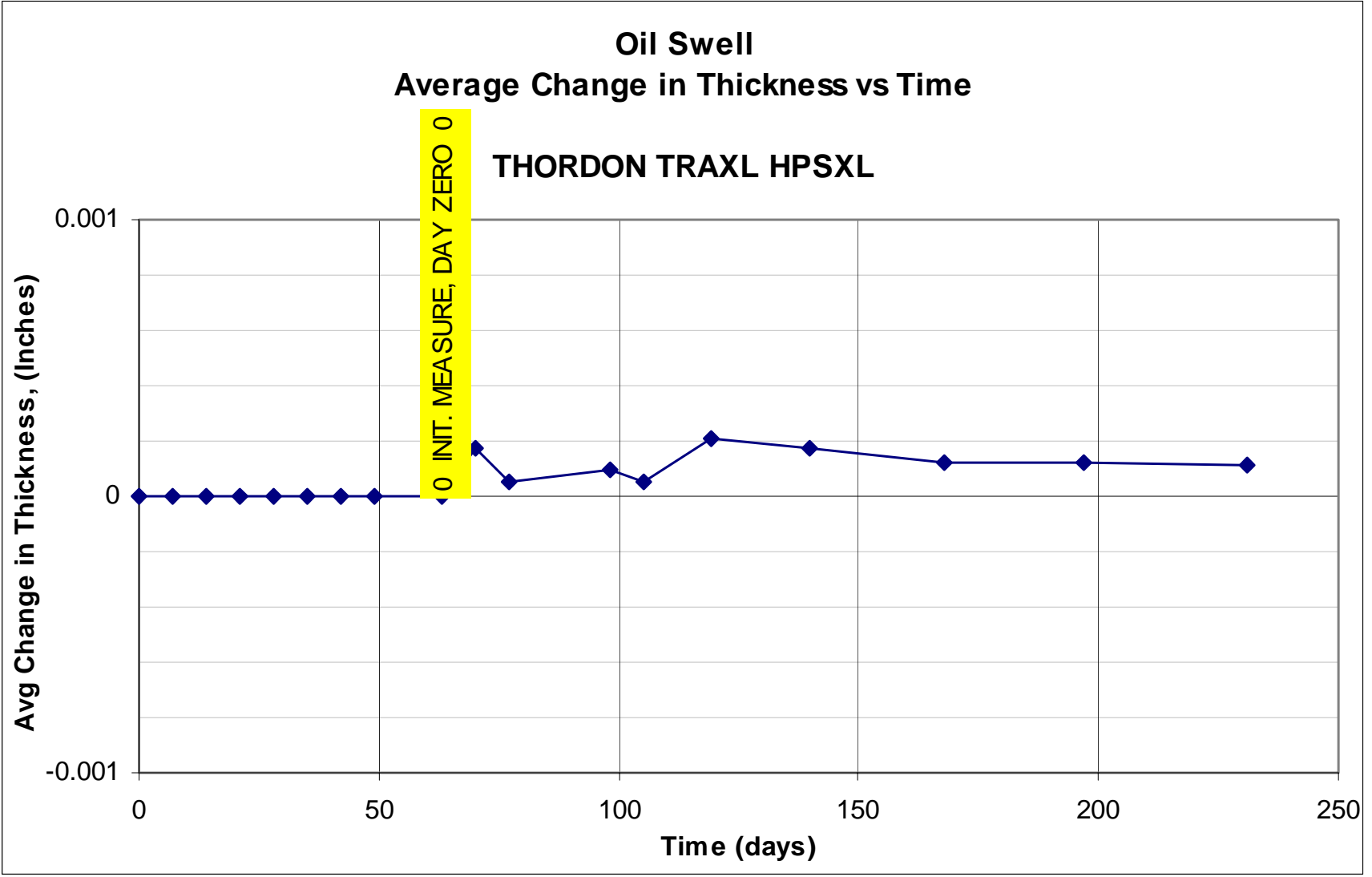

Figure E30. Average change in oil swell thickness vs time using Thordon TRAXL HPSXL.

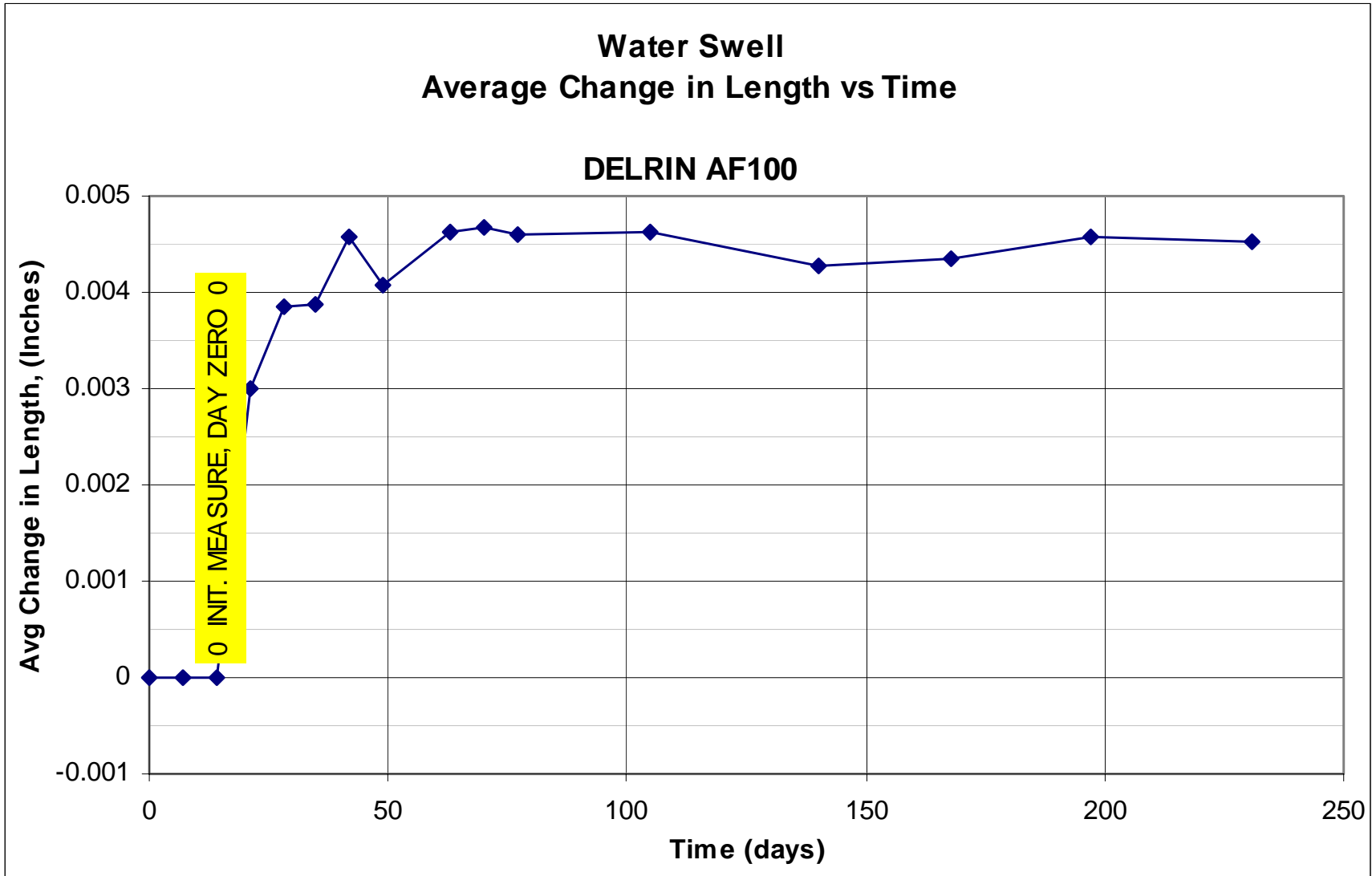

Figure E31. Average change in water swell length vs time using Delrin AF100.

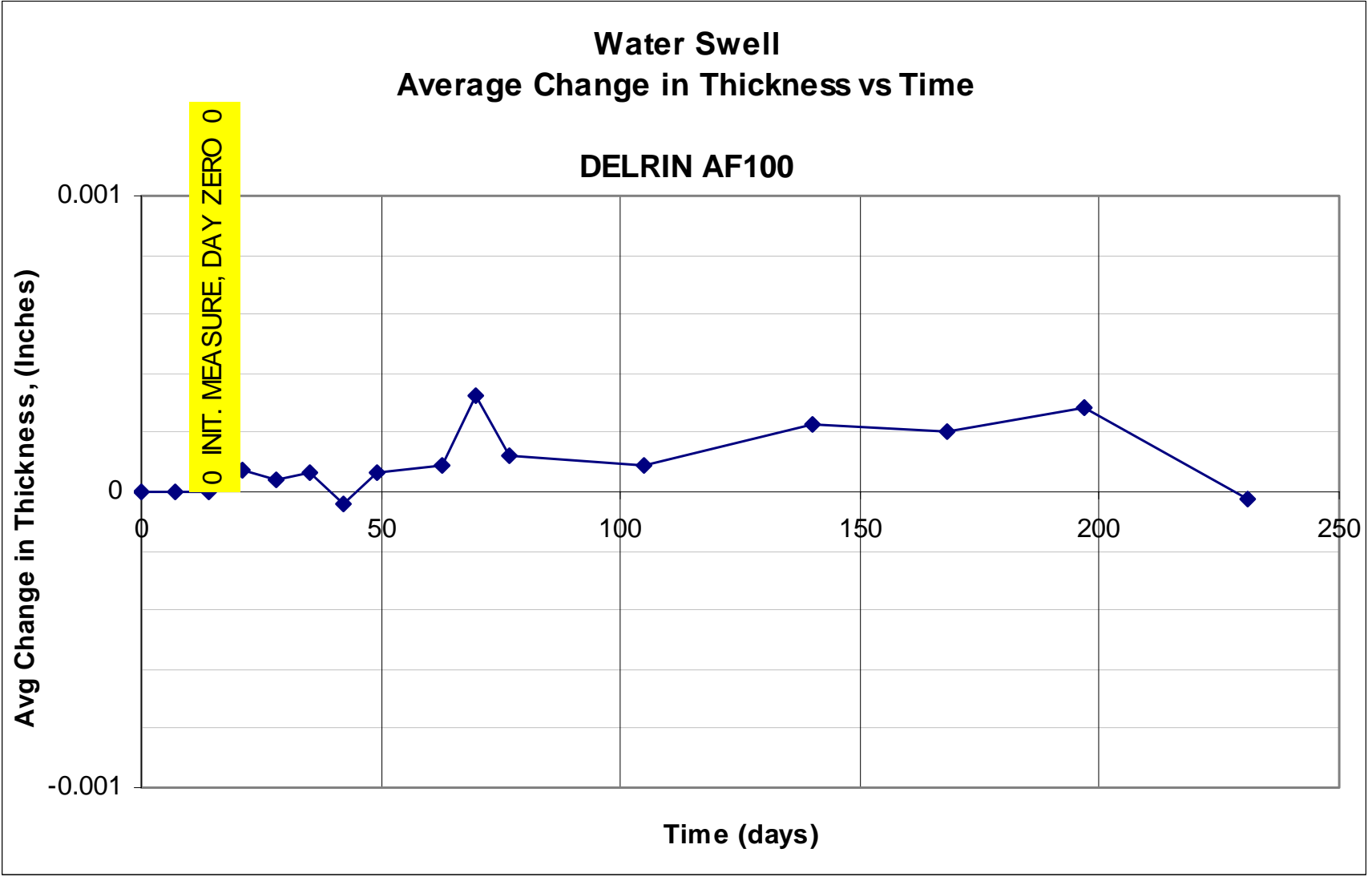

Figure E32. Average change in water swell thickness vs time using Delrin AF100.

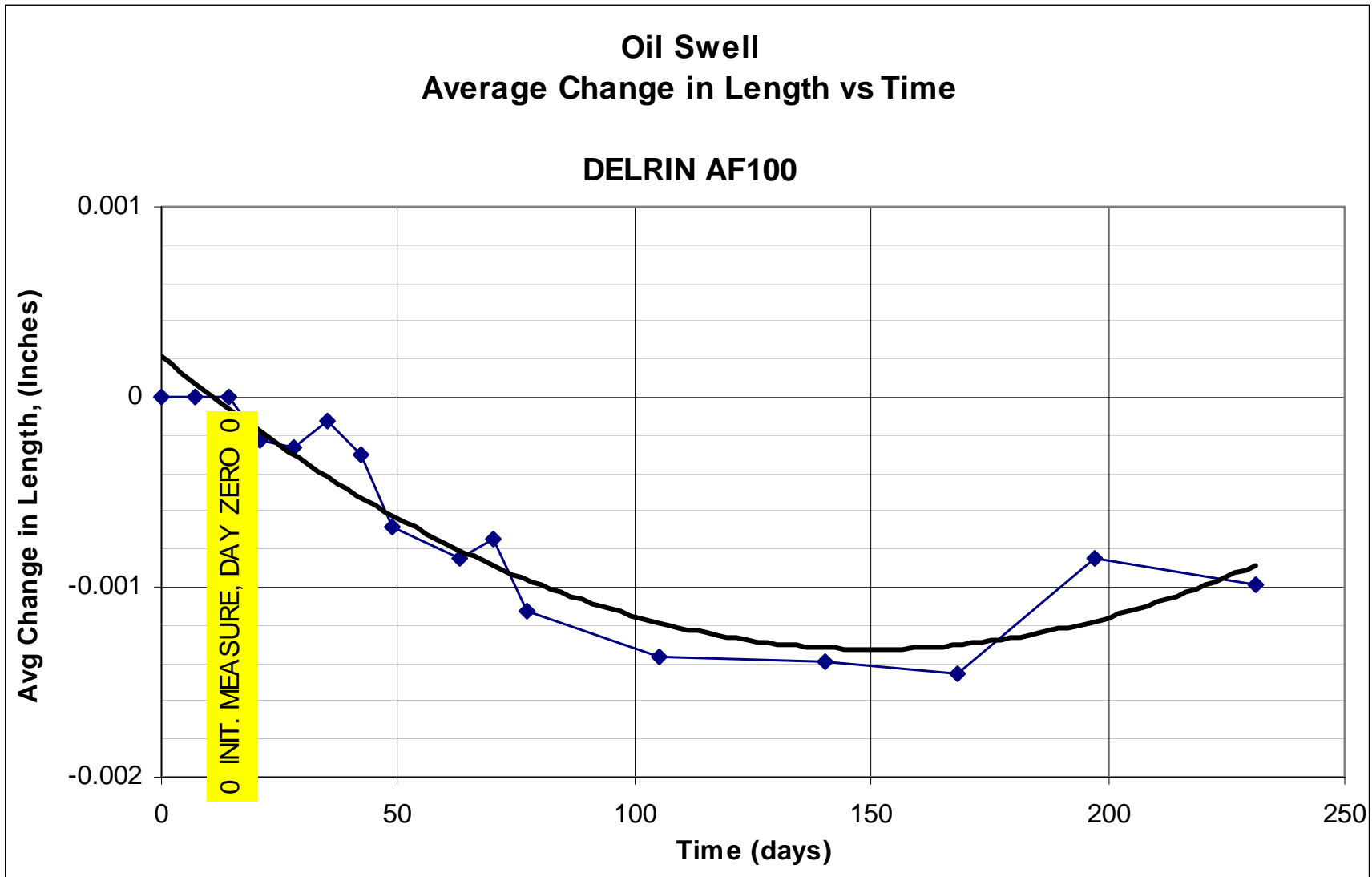

Figure E33. Average change in oil swell length vs time using Delrin AF100.

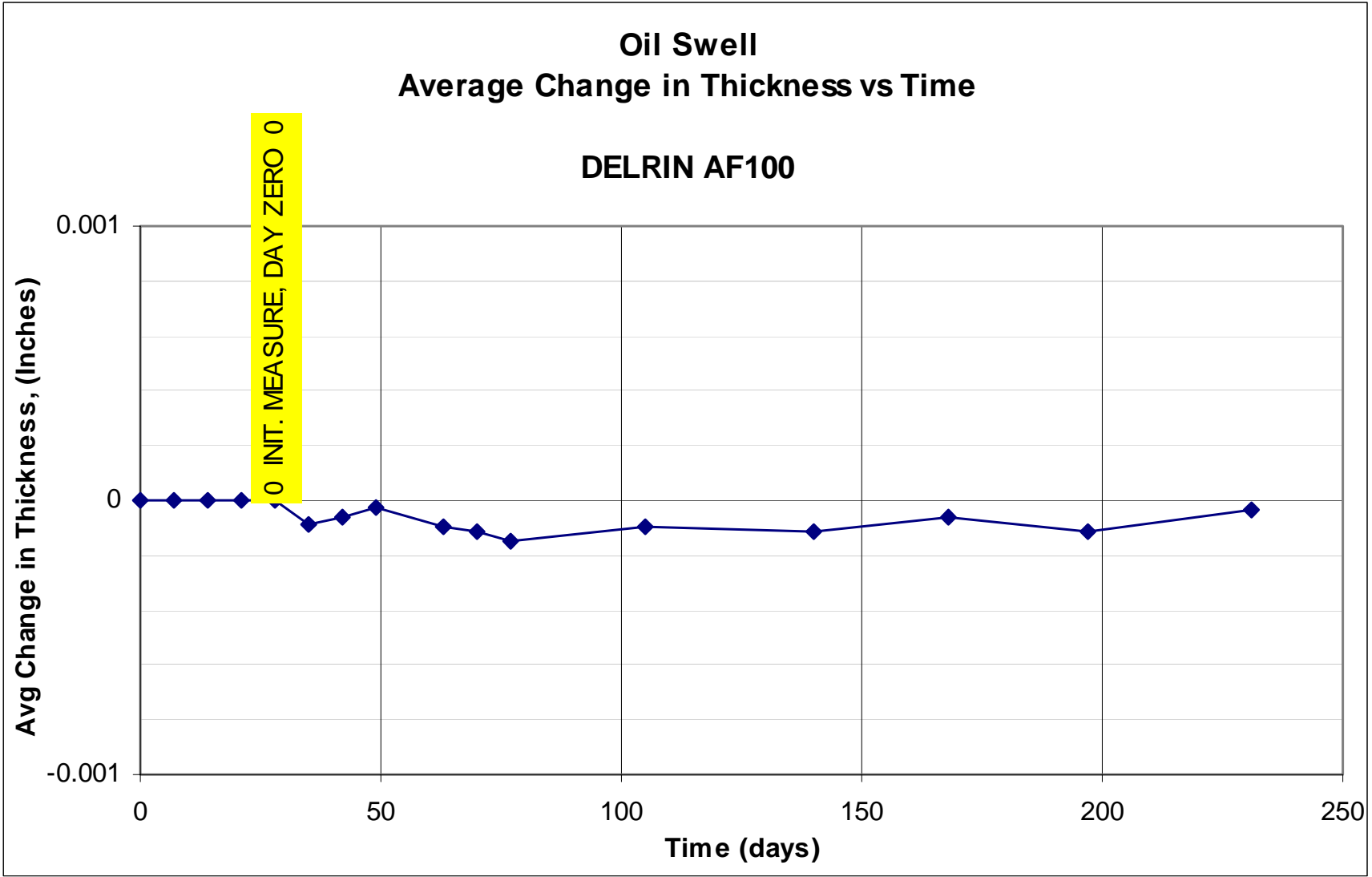

Figure E34. Average change in oil swell thickness vs time using Delrin AF100.

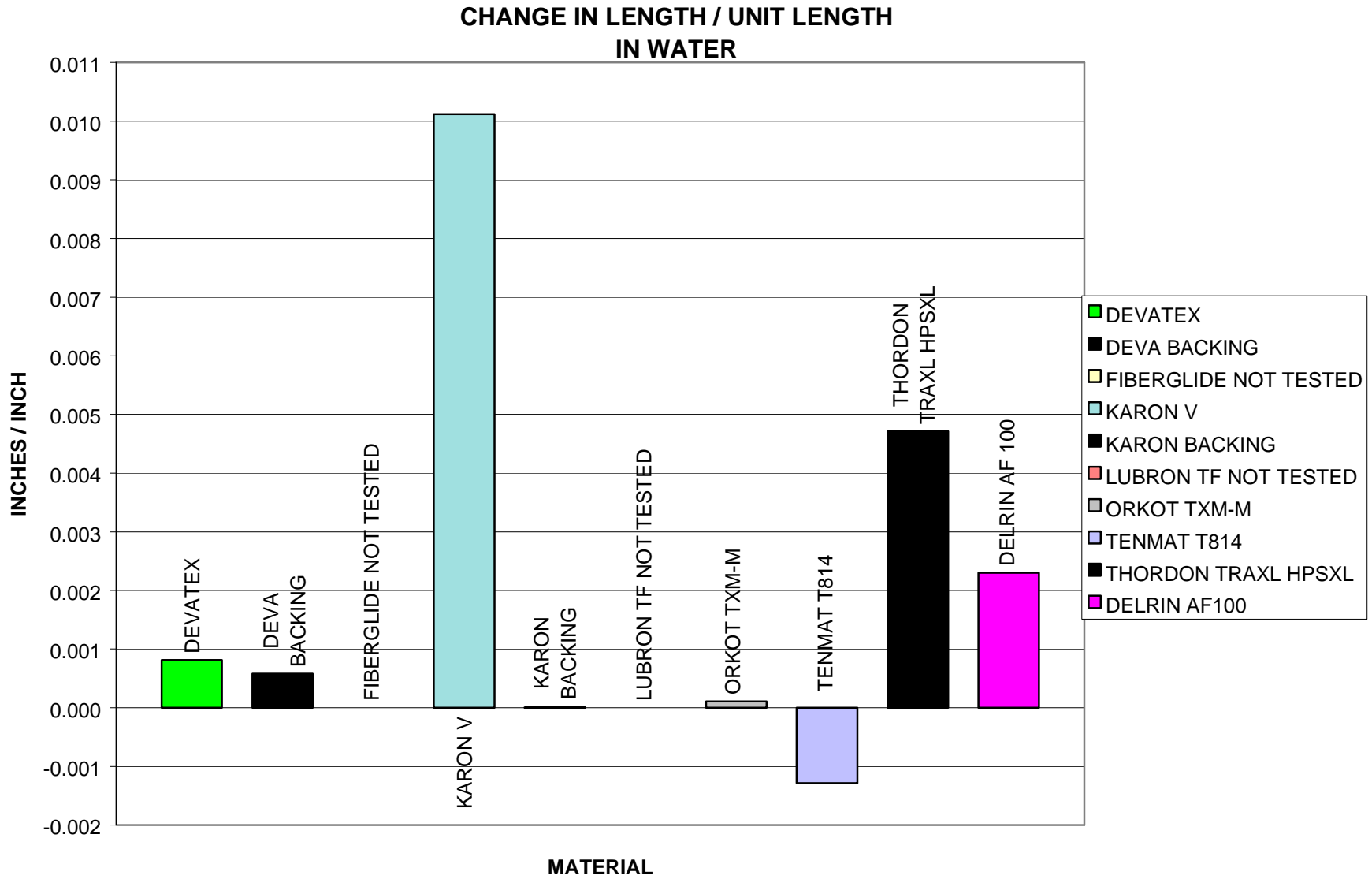

Figure E35. Change in material length per unit length in water.

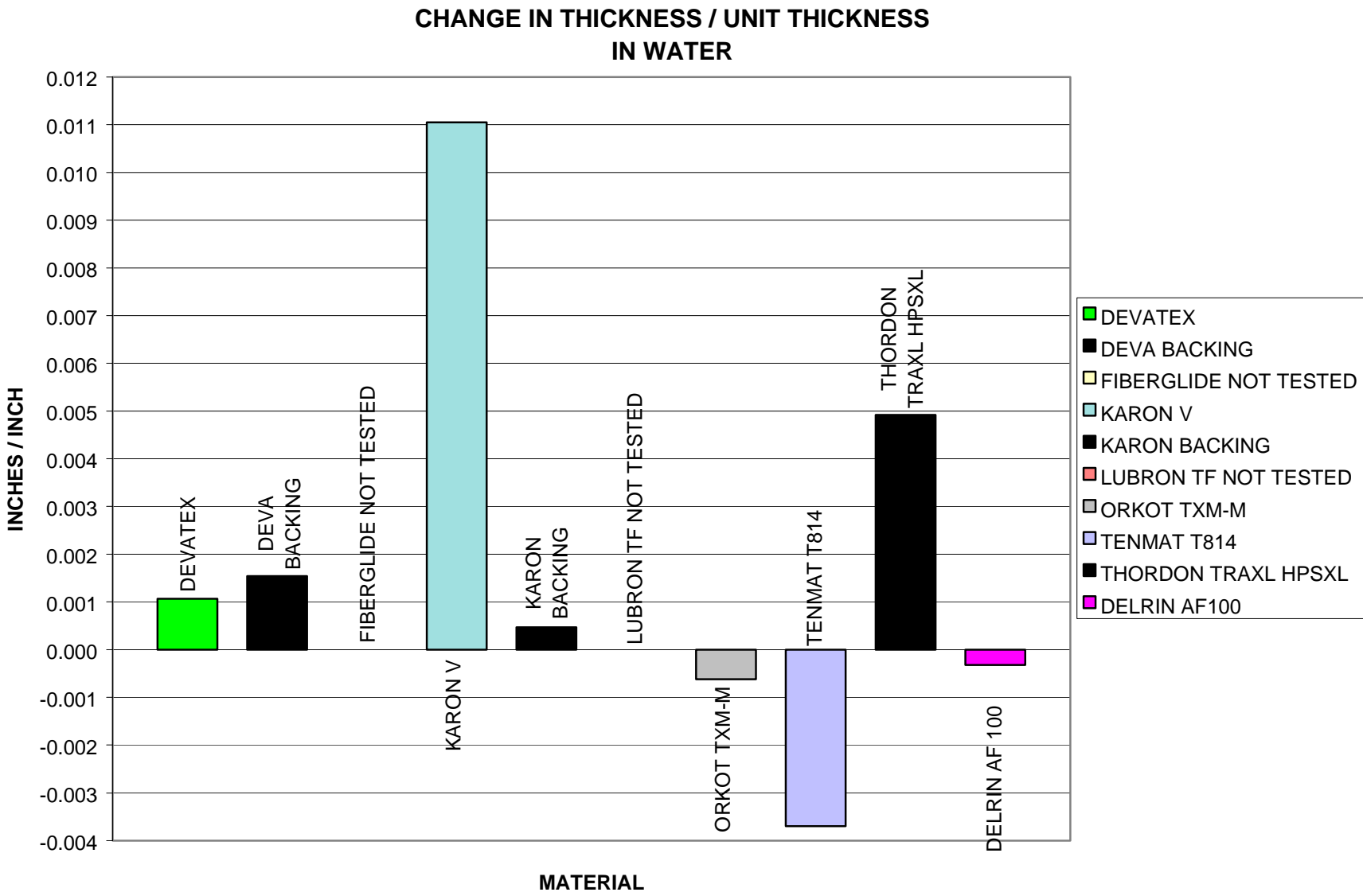

Figure E36. Change in material thickness per unit thickness in water.

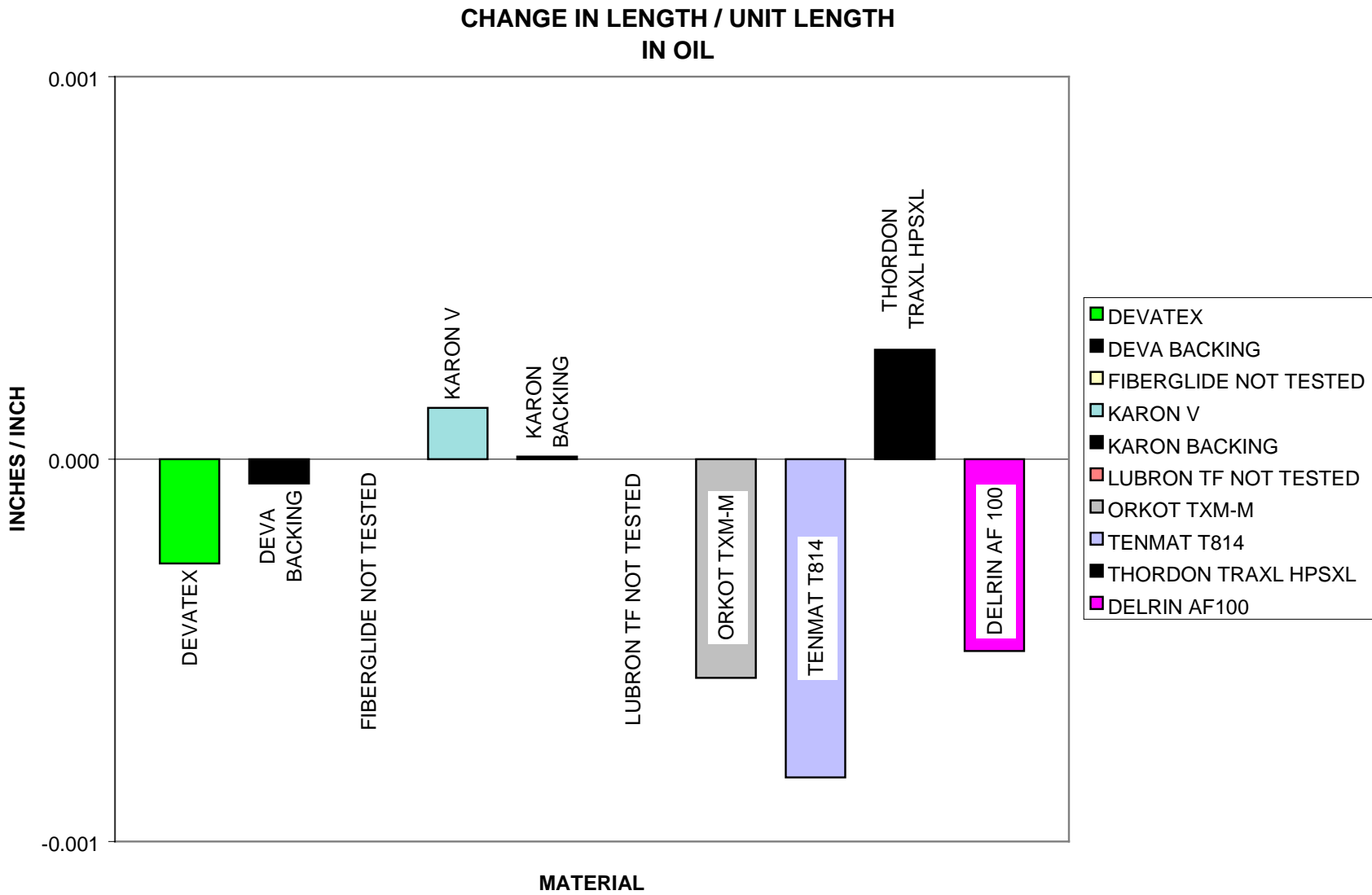

Figure E37. Change in material length per unit length in oil.

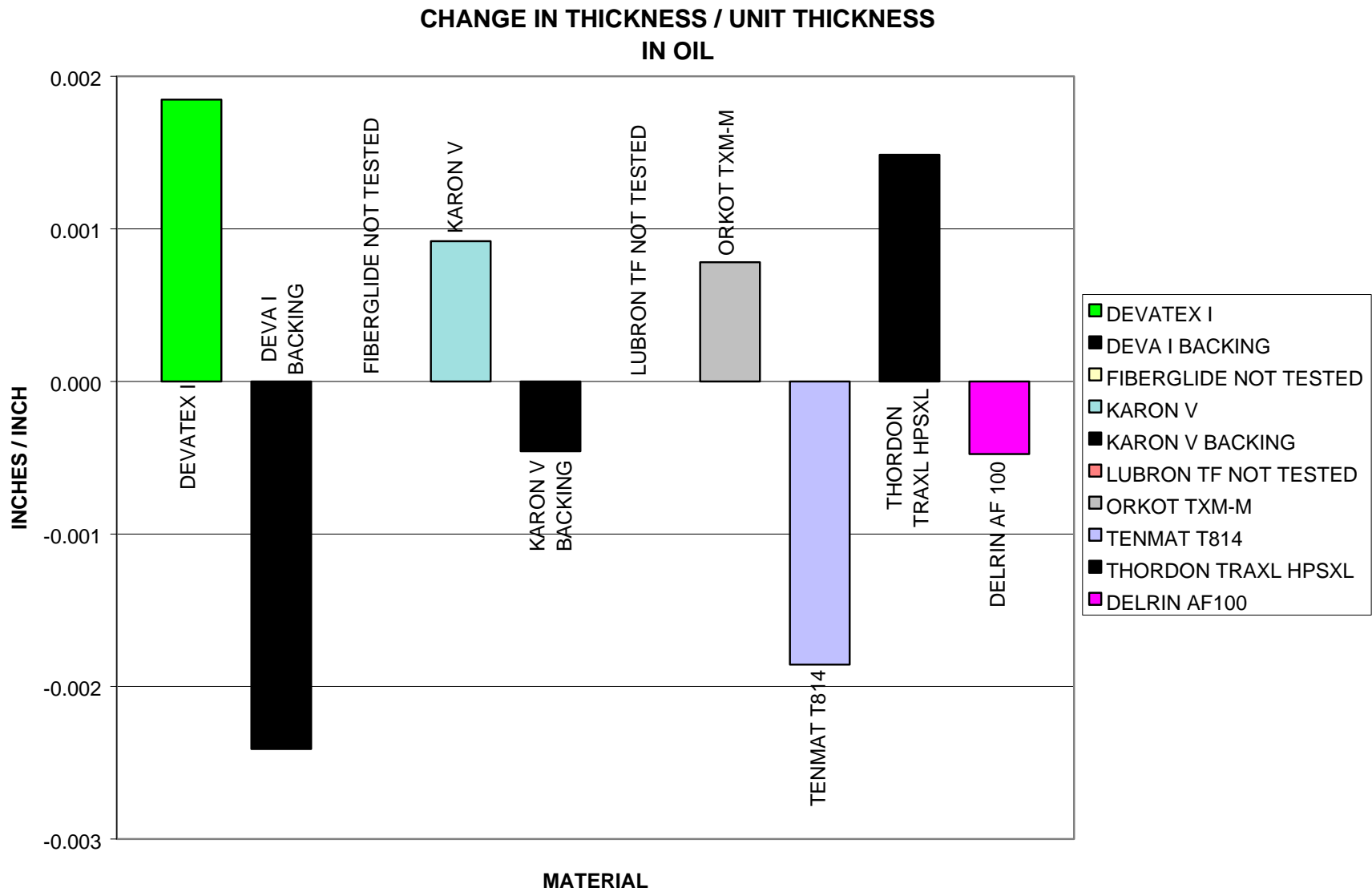

Figure E38. Change in material thickness per unit thickness in oil.

Conclusions

Time for Full Swell

Between 90 and 95 percent of full swell has occurred by the end of 8 months. Full swell of most material samples would apparently occur in less than 14 months.

Amount of Swell

Swell of most of the tested materials is small. Even the materials having the largest degree of swell should present no problem when normal bearing thicknesses and clearances are used. A Kamatics Karon V bearing having a 0.460 in. thick composite backing and 0.040 in. thick bearing layer would require only slightly over three thousandths of an inch diametrical clearance allowance for swell in water. In most cases, the normal clearances allowed for machinery assembly will be adequate to accommodate the bearing swell without additional allowances.

Material Softening

Some of the materials apparently soften on the surface in water, and some are softened by oil, probably all the way through. More investigation of this phenomenon is required.

Appendix F: The Bearing Rating System

Rating for Dry Use

Wicket Gate Linkages

For wicket gate linkages the system compares product dry performance to the performance of Greased Bronze for the same application.

Static Coefficient of Friction

1. Equal to Greased Bronze: scores 50 points.
2. For each 0.01 less than Greased Bronze: add 1 point.
3. For each 0.01 more than Greased Bronze: subtract 1 point.

Dynamic Coefficient of Friction

1. Equal to Greased Bronze: scores 50 points.
2. For each 0.01 less than Greased Bronze: add 1 point.
3. For each 0.01 more than Greased Bronze: subtract 1 point.

Stick-Slip Ratio Evaluated as Strain Energy Using Strain Area Ratio

1. Area Ratio equal 1 (same as Greased Bronze): scores 10 points.
2. Area Ratio greater than 1 (better than Greased Bronze): Add points equal to twice the Area Ratio.
3. Area Ratio less than 1 (worse than Greased Bronze): Subtract points equal to twice the reciprocal of the Area Ratio.

Wear Rate

1. Wear equal to Greased Bronze: scores 100 points.
2. For each 0.02 mil per 100 test hours less wear than Greased Bronze: add 1 point.
3. For each 0.02 mil per 100 test hours more wear than Greased Bronze: subtract 1 point.

Damage Susceptibility

1. Edge breakdown from edge loading:
 - None: scores 0 points
 - Detectable: subtract 25 points
 - Apparent: subtract 50 points
2. Bond breakdown from edge loading:
 - None: scores 0 points
 - Detectable: is UNACCEPTABLE, subtract 100 points.
3. Lubricant layer peelable from substrate:
 - Not: scores 0 points
 - Difficult: subtract 25 points
 - Not difficult: subtract 50 points

Apparent Surface Damage (Point Loss Is Exponential for Damage)

1. No damage: scores 100 points
2. Visible with unaided eye: subtract 10 points
3. Light damage: subtract 40 points
4. Readily apparent damage: subtract 90 points

Bearing Material Thickness

1. Basic thickness = 0.040 in.: scores 25 points
2. For each additional 0.010 in. thickness (up to a maximum thickness of 0.060 in.): add 5 points.
3. For each reduction of 0.010 in. thickness (down to a minimum of 0.020 in. thickness): subtract 5 points

Installation Guaranteed by Manufacturer's Insurance Policy?

If yes: add 2 points

Upper Wicket Gate Stem Bushings

Rated the same as Wicket Gate Linkage bushings except for Damage Susceptibility relating to Peelability. (Compares product dry performance to the performance of Greased Bronze for the same application.)

Damage Susceptibility

1. Lubricant layer peelable from substrate:
 - Not: scores 0 points
 - Difficult: subtract 50 points
 - Not difficult: subtract 100 points

Operating Ring Bearings

Rated the same as Wicket Gate Linkage bushings except for Damage Susceptibility relating to Edge Breakdown and Peelability. (Compares product dry performance to the performance of Greased Bronze for the same application.)

Damage Susceptibility

1. Edge breakdown from edge loading:
 - None: scores 0 points
 - Detectable: subtract 50 points
 - Apparent: subtract 100 points
2. Lubricant layer peelable from substrate:
 - Not: scores 0 points
 - Difficult: subtract 50 points
 - Not difficult: subtract 100 points

Hub Linkages (Dry Hub)

Rated the same as Wicket Gate Linkage bushings except for Damage Susceptibility relating to Edge Breakdown and Peelability. (Compares product dry performance to the performance of Oiled Bronze for the same application.)

Damage Susceptibility

1. Edge breakdown from edge loading:
 - None: scores 0 points
 - Detectable: subtract 50 points
 - Apparent: subtract 100 points
2. Lubricant layer peelable from substrate:
 - Not: scores 0 points
 - Difficult: subtract 50 points
 - Not difficult: subtract 100 points

Blade Trunnion Bushings (Dry Hub)

Rated the same as Wicket Gate Linkage bushings except for Damage Susceptibility relating to Edge Breakdown and Peelability. (Compares product dry performance to the performance of Oiled Bronze for the same application.)

Damage Susceptibility

1. Edge breakdown from edge loading:
 - None: scores 0 points
 - Detectable: subtract 50 points
 - Apparent: subtract 100 points

2. Lubricant layer peelable from substrate:
 - Not: scores 0 points
 - Difficult: subtract 100 points
 - Not difficult: subtract 200 points

Rating for Wet Use

Intermediate Wicket Gate Stem Bushings

Rated the same as Wicket Gate Linkage bushings except for Damage Susceptibility relating to Peelability. (Compares product wet performance to the performance of Greased Bronze for the same application.)

Damage Susceptibility

1. Lubricant layer peelable from substrate:
 - Not: scores 0 points
 - Difficult: subtract 50 points
 - Not difficult: subtract 100 points

Hub Linkages (Water-Filled Hub)

Rated the same as Wicket Gate Linkage bushings except for Damage Susceptibility relating to Edge Breakdown and Peelability. (Compares product wet performance to the performance of Oiled Bronze for the same application.)

Damage Susceptibility

1. Edge breakdown from edge loading:
 - None: scores 0 points
 - Detectable: subtract 50 points
 - Apparent: subtract 100 points
2. Lubricant layer peelable from substrate:
 - Not: scores 0 points
 - Difficult: subtract 50 points
 - Not difficult: subtract 100 points

Blade Trunnion Bushings (Water-Filled Hub)

Rated the same as Wicket Gate Linkage bushings except for Damage Susceptibility relating to Edge Breakdown and Peelability. (Compares product wet performance to the performance of Oiled Bronze for the same application.)

Damage Susceptibility

1. Edge breakdown from edge loading:
 - None: scores 0 points
 - Detectable: subtract 50 points
 - Apparent: subtract 100 points
2. Lubricant layer peelable from substrate:
 - Not: scores 0 points
 - Difficult: subtract 100 points
 - Not difficult: subtract 200 points

Lower Wicket Gate Stem Bushings

Rated the same as Wicket Gate Linkage bushings except for Damage Susceptibility relating to Peelability. (Compares product wet performance to the performance of Greased Bronze for the same application.)

Damage Susceptibility

1. Lubricant layer peelable from substrate:
 - Not: scores 0 points
 - Difficult: subtract 100 points
 - Not difficult: subtract 200 points

System Change in Strain Energy vs Bearing Stick-Slip

General

Stick-Slip Ratio

The concept of the stick-slip ratio of a bearing being an important factor in rating “greaseless” bearings for smoothness of operation was included in the original Corps Bearing Rating System. Stick-slip ratio, as used here, is the value obtained by dividing the Static Coefficient of friction by the Dynamic Coefficient of friction: (F_s/F_d) .

In the original Corps Bearing Rating System a basic value was assigned to the stick-slip ratio of bronze. The stick-slip ratio of the greaseless bearing being rated was subtracted from the stick-slip ratio of greased bronze or oiled bronze, as appropriate. If the remainder was positive, points were added to the basic value and the resulting sum became the value for the subject bearing. If the remainder was negative, points were subtracted from the basic value and the resulting sum became the value for the subject bearing.

Upon further evaluation it became clear that, by considering only the stick-slip ratios, some bearings with very low coefficients of friction were being rated lower than other bearings with higher coefficients of friction. To correct this distorted rating result, a more rational approach was required.

System Strain Energy

System strain energy is the energy that is stored in the form of elastic deformations of the system’s parts that result from forces being applied to the system. In effect, a system such as the wicket gates and associated linkages and servos may be considered to be a spring. When the servo forces, the hydraulic load, and the resistance of the bearings to being rotated are applied to the gate system the parts undergo small elastic deformations, compressing that “spring.”

As the system transitions from the loads required to overcome the static coefficient of friction to the lesser loads required to maintain motion against the resistance of the dynamic coefficient of friction, the system parts “relax” somewhat and the strain energy of the “spring” is reduced. The motions of the parts are sudden when the applied force overcomes the resistance caused by the static coefficient of friction and the resistance suddenly drops to that provided by the dynamic coefficient of friction. The magnitude of the change in strain energy from

static loading to dynamic loading determines the amount of sudden motion the parts undergo when that transition occurs.

These small, sudden motions are called “shudder,” “jerk,” or “stick-slip” and are a measure of how smoothly a system moves. The stick-slip action of a bearing causes noise as the system parts vibrate from the sudden small movements.

It is reasonable then to try to evaluate the change in strain energy of the system and use that Strain Energy Change to rate the bearings for smooth operation rather than use the stick-slip ratio as defined earlier.

Strain Energy Evaluation

If a graph is drawn plotting coefficient of friction along both the ordinate and abscissa and having zero at the origin, all coefficients of friction will fall on a 45 degree line extending from the origin. Just as the area under the “curve” of a graph of force versus deflection of a spring represents the spring stored energy at any specified deflection, so will the graph of coefficients of friction represent stored energy resulting from system resistance caused by friction.

Thus, the area under the curve which results from plotting the Static coefficient of friction, minus the area resulting from plotting the Dynamic coefficient of friction represents the change in stored energy of the system or the Strain Energy Change between static and dynamic loading. When the area representing the Strain Energy Change associated with any bearing is compared to the Strain Energy Change associated with any other bearing, the two bearings may be ranked for smoothness of operation. It is apparent that the bearing having the lesser Strain Energy Change will operate the smoother regardless of loads or system stiffness.

The procedure for determining the value of this performance factor will be to first calculate the area of Strain Energy Change for greased or oiled bronze as is appropriate, and assign a basic value to that number. Next, calculate the Strain Energy Change areas for both the dry and wet conditions for each of the tested bearings. Finally, divide the area of Strain Energy Change for bronze (greased or oiled, as appropriate) by the area of Strain Energy Change of the tested bearing (wet or dry, as appropriate). If the resulting quotient, area ratio or Strain Energy Change Ratio equals 1, the test bearing will receive the basic value rating. If the resulting quotient is greater than 1, the test bearing will receive a value rating greater than the basic value. If the quotient is less than 1, the test bearing will receive a value rating less than the basic value.

For bearings having an Area Ratio (Strain Energy Change Ratio) greater than 1, the points added to the basic value will be: 2 times the Area Ratio, with an upper limit of 20 additional points. Thus if the area ratio $AR = 1.836$, the added points would be $(2)(1.836) = 3.672$. If the area ratio $AR = 24.291$, the added points would be $(2)(24.291) = 48.582$, but would be limited to 20.00.

For bearings having an Area Ratio less than 1, the points subtracted from the basic value will be: two times the reciprocal of the area ratio. Thus if

$AR = 0.200$, the subtracted points would be $(2)(1/0.200) = 10$.

Note that the use of the concept of system change in strain energy versus that of bearing stick-slip ratio has little effect on the overall rating of a bearing. The advantage of using the concept of change in strain energy lies in its simplicity of use. The comparison of change of strain energy areas directly compares operational smoothness. Conversely, comparison of stick-slip in itself tells little. Several bearings have been tested that exhibit very high coefficients of friction but low stick-slip ratios. Under the system of comparing the stick-slip ratios, such bearings were receiving added points even though their area of change in strain energy was larger than the area of change in strain energy for bronze.

Appendix G: Rating the Bearings

Overview

Thousands of hours of laboratory testing of greaseless bushings have been performed over the past 4 years under a program initiated by the Corps of Engineers and carried out by Powertech Laboratories, in Surrey, BC, Canada. The purpose of the tests was to determine bearing performance characteristics with the intent to use the bearings in oscillating-motion hydropower applications. Such applications are principally on wicket gates and their linkages, and turbine blades and their linkages in Kaplan-type turbines. Coefficients of friction and wear rates have been determined for both wet and dry and edge-loaded operating conditions. A substantial database has been compiled which compares the performance of the various greaseless bushings with each other and with that of conventional greased or oiled bronze.

Many features have been examined in the process of testing which do not lend themselves to simple charting, yet can be very important. Examples of this are: bearing layer thickness, integrity of bonding to substrate, apparent damage to bearing surface without measurable change in bearing performance during testing, etc. A rating system is required which allows the weighting of characteristics, which are important for a specific application such that direct selection of bushings is possible.

This work presents the results of applying the rating system to laboratory test results to relate bearing performance to requirements of specific applications. Appendix F defines the rating system. Included are the rationales for the rating factors used, plus several concrete examples which show the bar charts resulting from the laboratory tests, and the rating charts which result from applying the Corps weighting factors.

The charts are intended to provide direct comparison of bearings for the intended use. The charts include the rating of greased or oiled bronze for the same service. There are usually several bearings for each application that have similar ratings. Selection of a specific product must depend not only on the

rating, but also on price, delivery, and engineering support provided by the company.

Recognition of Need for a Bearing Rating System

The greaseless bushings tested here for use in hydropower applications differ broadly in their performance, and the performance of most individual products is dependent upon whether the operation is wet or dry, or is “edge loaded”.

Some products have lower coefficients of friction but higher wear rates when they are wet than when they are dry, while for other products the reverse is true. This means there is no “clear winner” for use in all applications, and therefore it is necessary to apply a rating system to the lab test results to determine the bushing material that performs best for each individual application.

Development of a Bearing Rating System

Information from Corps power plant operating and maintenance personnel was used to determine what bearing performance characteristics were most important, and to develop the “weighting” factors used in the below rating system. The weighting factors reflect the relative importance placed on each bearing characteristic by the O&M personnel.

Long-term creep characteristics and ultimate swell of the materials in water and oil are not included in the below rating system. Results of swell tests to date are included in Appendix E.. Tests for long-term creep have been defined, but the program has not yet been initiated.

The below rating charts result from using an EXCEL spreadsheet to manipulate the data from the lab tests, in accordance with the Rating System, and automatically generate the charts for each listed bearing use. Because of the poor performance of a few of the bearings in some tests, those bearings are not rated in the charts for specific uses where their performance was poor.

Bearing Dry Performance

The rating system compares the product dry performance (wear rate, static and dynamic coefficients of friction, and the “Strain Energy Change”; see Appendix F) to the performance of Greased Bronze for each application where the service

environment is normally dry (i.e., wicket gate linkages and upper wicket gate stem bushings).

Bearing Wet Performance

The rating system compares the product wet performance to the performance of Greased Bronze for each application where the service environment is normally wet (i.e., intermediate and lower wicket gate stem bushings).

Bearing Performance Compared With Bronze

The rating system compares the product wet or dry performance, depending on whether the turbine hub is to be water or air filled, to the performance of Oiled Bronze for each application where the service is normally submerged in oil (i.e., turbine hub linkages and turbine blade trunnions).

Bearing Peeling From Substrate

In some areas, such as the lower wicket gate stem bushings and the turbine blade trunnion bushings, the resistance of the bearing material to being peeled away from the substrate during assembly of the gates or blades is more important than at other locations such as linkage bushings. "Blind" assemblies, where the parts are large and heavy, and the other end of the bushing is not visible (i.e., lower wicket gate stem bushings and inner blade trunnion bushings) are more severely penalized for any tendency to be peelable than applications such as linkage bushings where the parts are relatively small, light, and visible. This rating system is designed around direct replacement of greased or oiled bronze bushings by greaseless bushings. In cases where the leading edges of the shaft and/or shaft sleeve will be modified to have a smooth "spherical" shape before reassembly of the unit, the peelability penalty should be appropriately reduced. In such cases, assessed penalties could reasonably be reduced to 25 percent of those shown in the rating system.

Hidden Damage

In some cases, the bushing surface has exhibited damage from the test, even though none of the measurements of the test (wear rate, friction, temperature, etc.) showed any increase. A visual inspection of the bushing after the testing allows a subjective rating as to the presence and severity of the surface damage. A "squared" term is used in this rating for surface damage to deliberately penalize for increased apparent damage.

Bearing Material Thickness

The wear rate of nearly every one of the greaseless bushing materials is but a fraction of that for bronze under the same conditions, therefore the bearing material thickness is given relatively low value.

Product Insurance Policy

At least one bushing manufacturer provides a limited insurance policy with its product, which would allow monetary recovery up to specific amounts in case of product failure in service. This insurance shows the company's confidence in their product, and is commendable. The provision of the insurance is given little weight in the rating system, however, because selection is to be based on product performance rather than guarantees. The insurance is here treated more as "icing on the cake."

Friction Coefficients and Wear Rates (Delrin)

Figure G1 illustrates a material (Delrin AF100) that has higher coefficients of friction, but markedly lower wear rate, when operated wet than when operated dry. The second material (Devatex I) exhibits both higher coefficients of friction and much higher wear rate when operated wet than when operated dry.

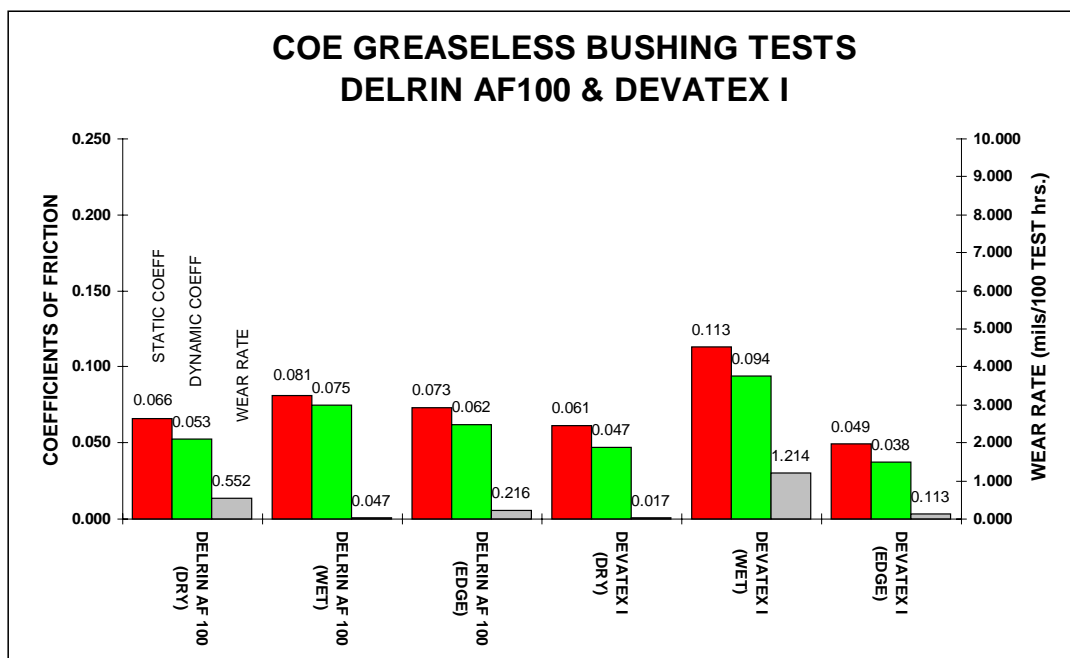

Figure G1. COE greaseless bushing tests, Delrin AF100 and Devatex I.

Friction Coefficients and Wear Rates (Tenmat T12, T814)

Figure G2 illustrates a material (Tenmat T814) that has somewhat higher coefficients of friction but markedly lower wear rate when operated wet than when operated dry. The other material (Tenmat T12) exhibits slightly higher coefficients of friction and unparalleled lower wear rate when operated wet than when operated dry. Not illustrated are two materials that exhibited lower coefficients of friction but higher wear rates when operated wet than when operated dry.

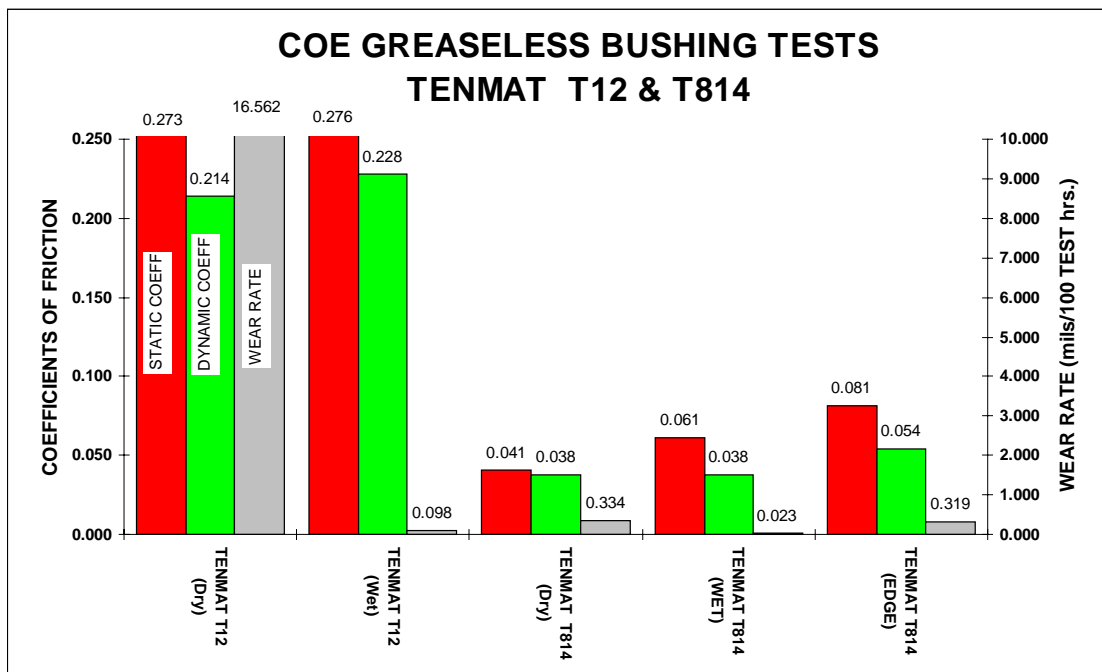

Figure G2. COE greaseless bushing tests, Tenmat T12 and T814.

Results of Applying the Bearing Rating System

Results of applying the rating system are illustrated below for two cases, one wet and one dry. Figure G3 shows that, for application as Upper Stem Bushings (operating dry), Tenmat T814 is rated #1 and Devatex I is rated #2. Figure G4 shows that, for application as Lower Stem Bushings (operating wet), Tenmat T814 is rated #1 and Devatex I is rated #7. Figures G3 through G11 are the rating charts resulting from application of the rating system to the laboratory test results.

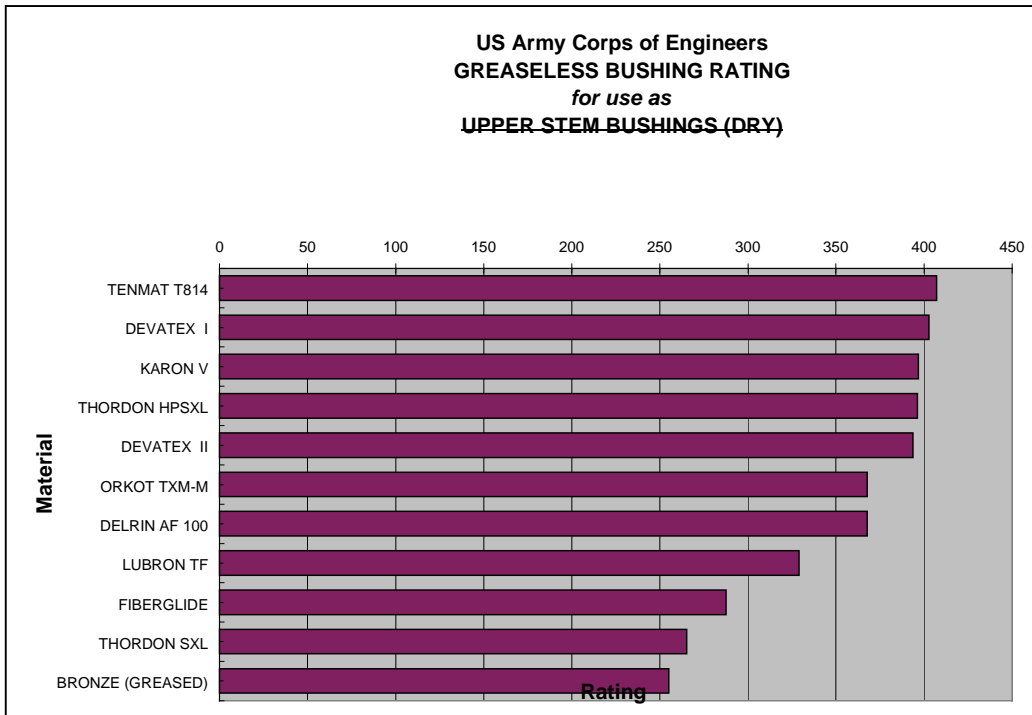

Figure G3. Greaseless bushing rating for use as upper stem bushings (dry).

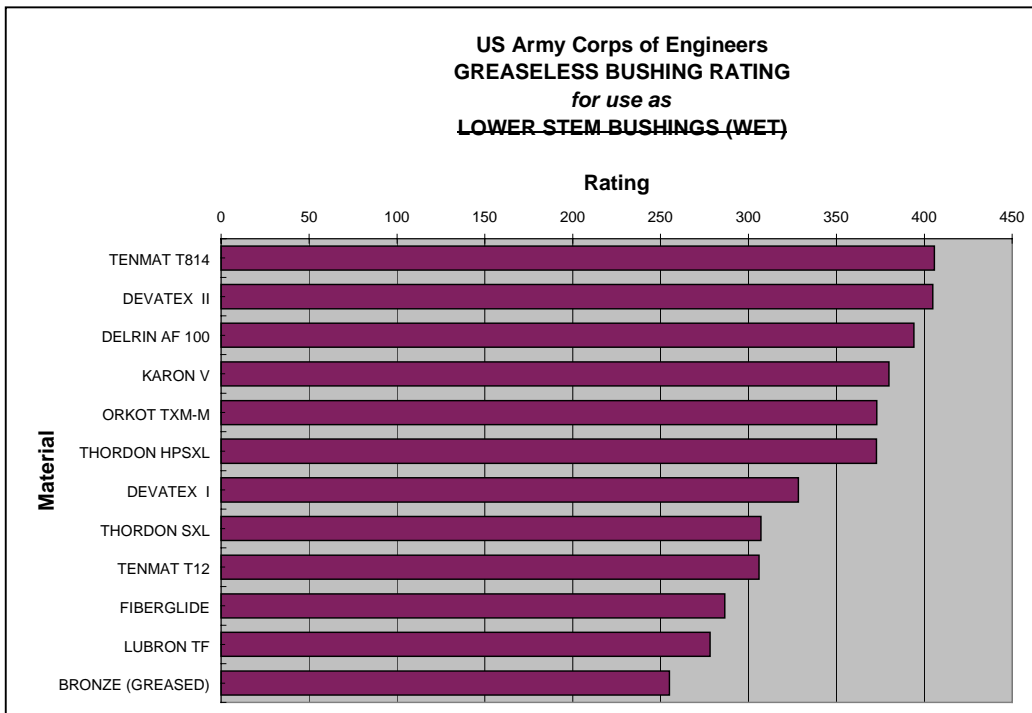

Figure G4. Greaseless bushing rating for use as lower stem bushings (wet).

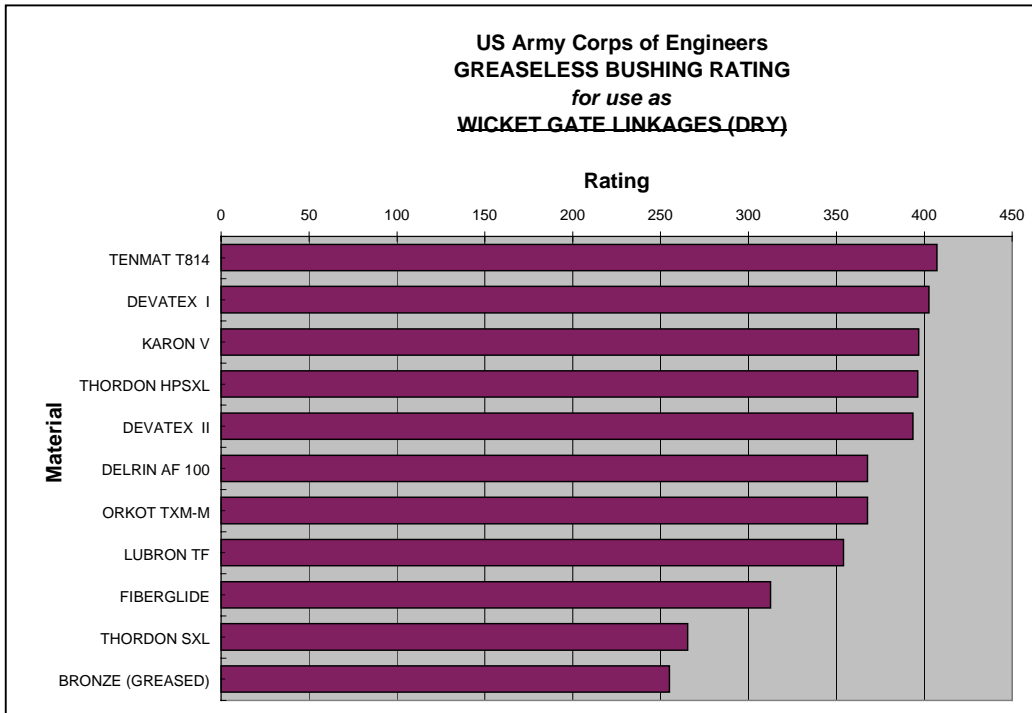

Figure G5. Greaseless bushing rating for use as wicket gate linkages (dry).

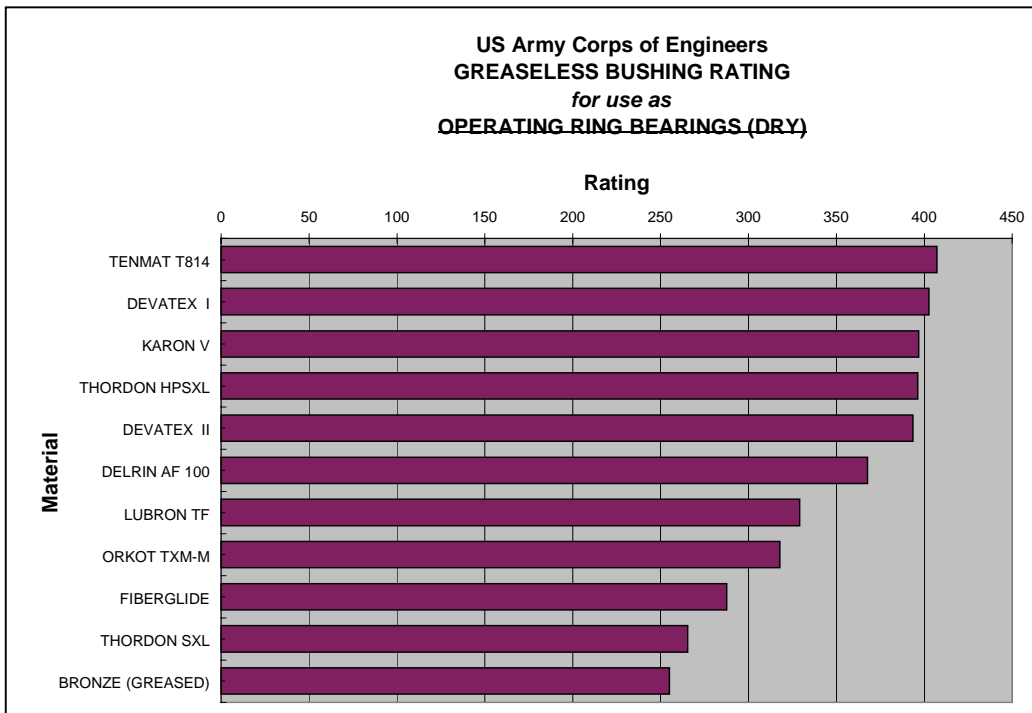

Figure G6. Greaseless bushing rating for use as operating ring bearings (dry).

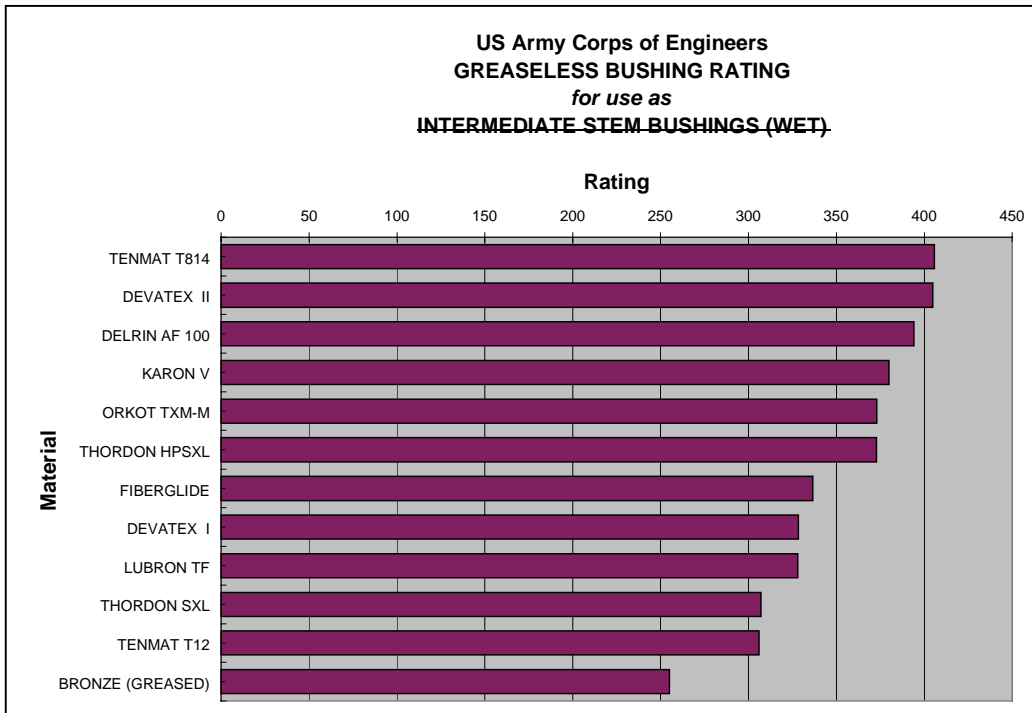

Figure G7. Greaseless bushing rating for use as intermediate stem bushings (wet).

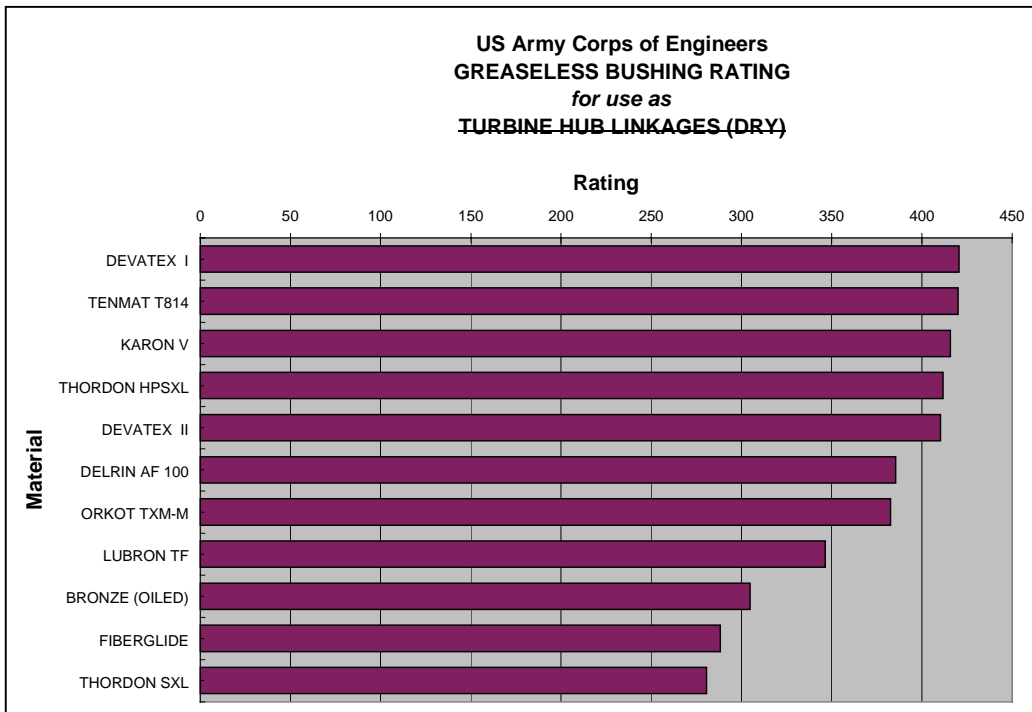

Figure G8. Greaseless bushing rating for use as turbine hub linkages (dry).

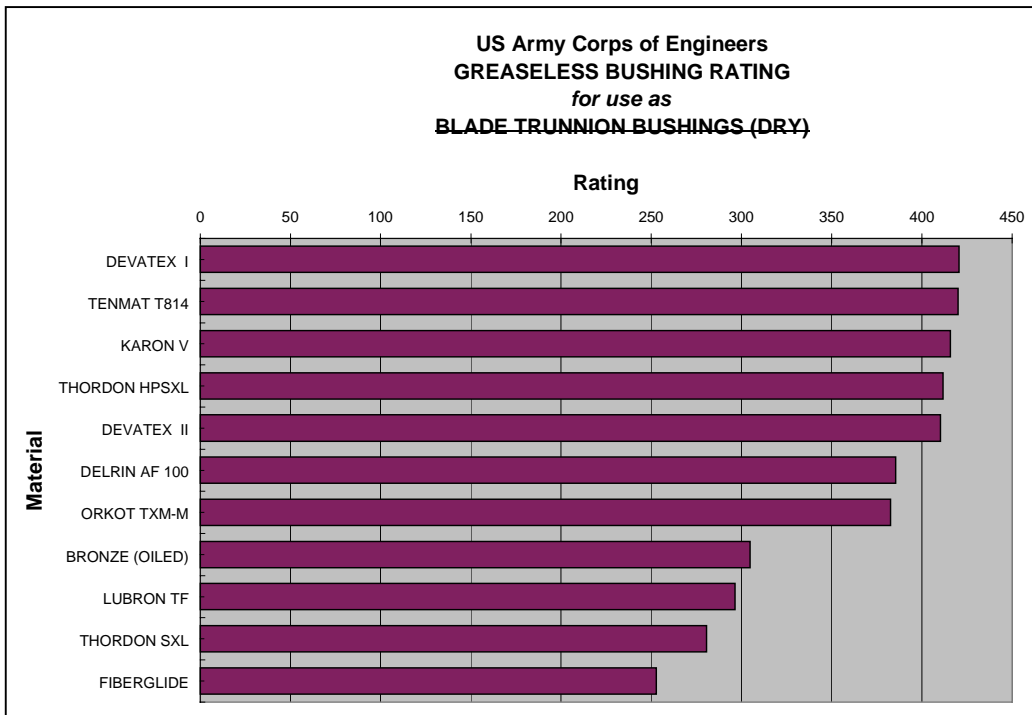

Figure G9. Greaseless bushing rating for use as blade trunnion bushings (dry).

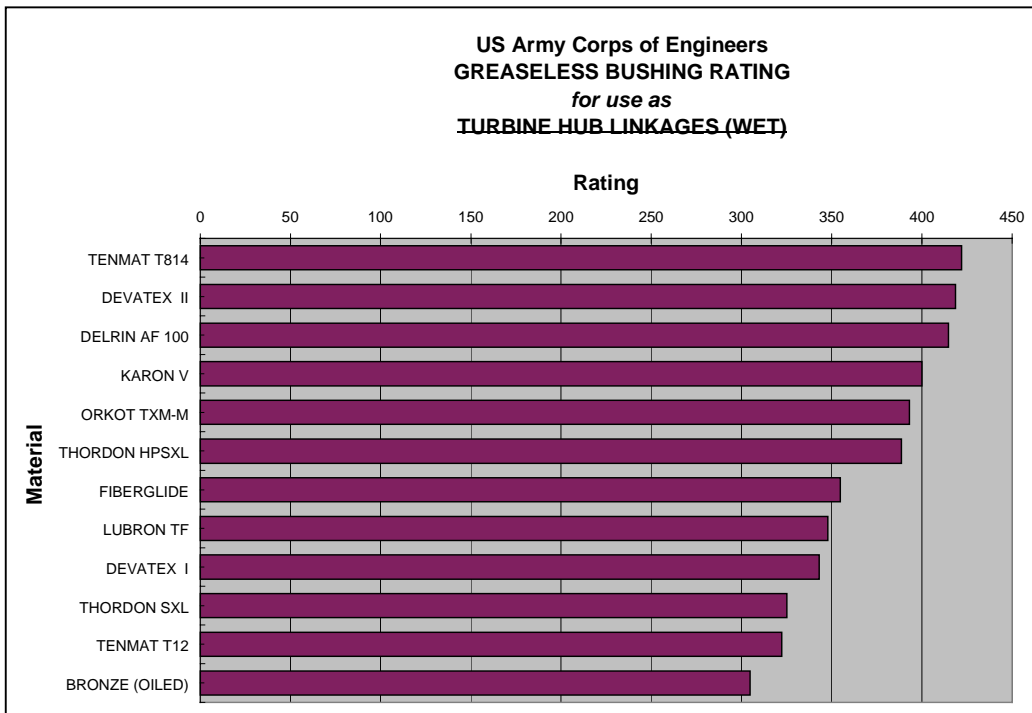

Figure G10. Greaseless bushing rating for use as turbine hub linkages (wet).

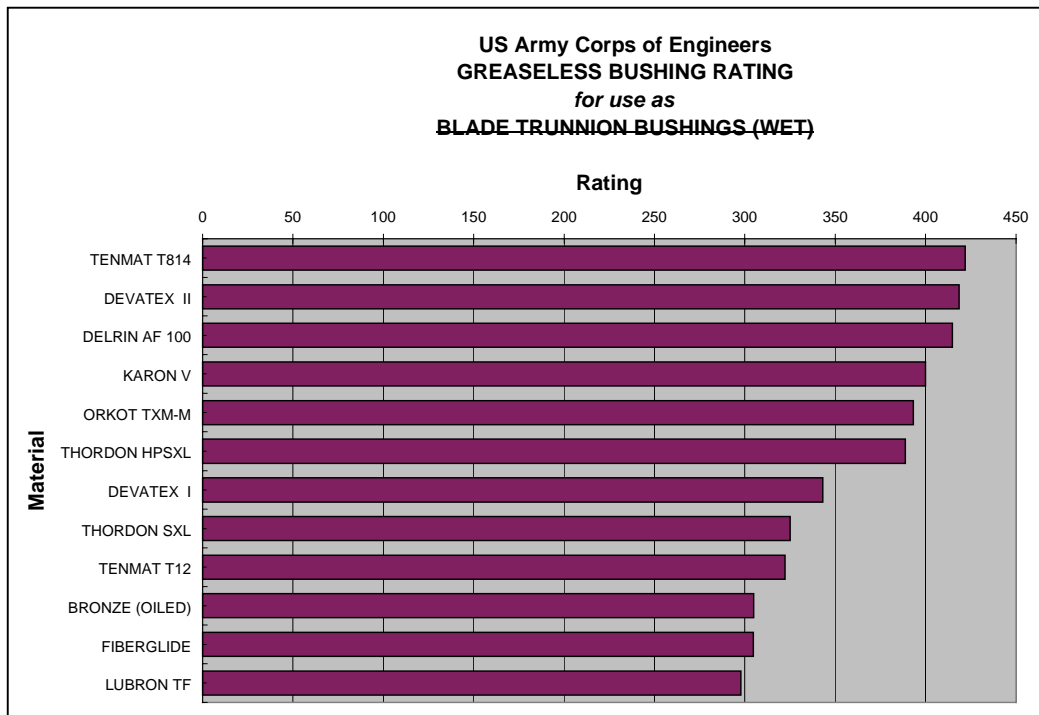

Figure G11. Greaseless bushing rating for use as blade trunnion bushings (wet).

Conclusions

1. The greaseless bushings tested here for use in hydropower applications vary widely in performance.
2. The performance of most individual products is dependent upon whether the operation is wet or dry, or is "edge loaded".
3. Some products have lower coefficients of friction but higher wear rates when they are wet than when they are dry, while for other products the reverse is true. This means there is no "clear winner" for use in all applications.
4. It is necessary to apply a rating system to the lab test results to determine the bushing material that performs best for each individual application.
5. The charts provide direct comparison of bearings for the intended use and they include the rating of greased or oiled bronze for the same service.

Usually several bearings have similar ratings for each application. Selection of a specific product must depend not only on the rating, but also on price, delivery, and engineering support provided by the bearing manufacturer.

Distribution

Chief of Engineers

ATTN: CEHEC-IM-LH (2)
ATTN: HECSA Mailroom (2)
ATTN: CECC-R
ATTN: CERD-L
ATTN: CERD-M
ATTN: CECW-ET

Hydroelectric Design Center (2)
ATTN: CENWP-HDC-A 97204

Defense Tech Info Center 22304
ATTN: DTIC-O (2)

12
9/99

REPORT DOCUMENTATION PAGE

Form Approved
OMB No. 0704-0188

Public reporting burden for this collection of information is estimated to average 1 hour per response, including the time for reviewing instructions, searching existing data sources, gathering and maintaining the data needed, and completing and reviewing the collection of information. Send comments regarding this burden estimate or any other aspect of this collection of information, including suggestions for reducing this burden, to Washington Headquarters Services, Directorate for Information Operations and Reports, 1215 Jefferson Davis Highway, Suite 1204, Arlington, VA 22202-4302, and to the Office of Management and Budget, Paperwork Reduction Project (0704-0188), Washington, DC 20503.

1. AGENCY USE ONLY (Leave Blank)		2. REPORT DATE December 1999	3. REPORT TYPE AND DATES COVERED Final	
4. TITLE AND SUBTITLE Greaseless Bushings for Hydropower Applications: Program, Testing, and Results			5. FUNDING NUMBERS 32820/315	
6. AUTHOR(S) John A. Jones, Rick A. Palylyk, Paul Willis, and Robert A. Weber				
7. PERFORMING ORGANIZATION NAME(S) AND ADDRESS(ES) U.S. Army Construction Engineering Research Laboratory (CERL) P.O. Box 9005 Champaign, IL 61826-9005			8. PERFORMING ORGANIZATION REPORT NUMBER TR 99/104	
9. SPONSORING / MONITORING AGENCY NAME(S) AND ADDRESS(ES) Headquarters, U.S. Army Corps of Engineers (HQUSACE) ATTN: CECW-ET 20 Massachusetts Avenue, NW Washington, DC 20314-1000			10. SPONSORING / MONITORING AGENCY REPORT NUMBER	
9. SUPPLEMENTARY NOTES Copies are available from the National Technical Information Service, 5385 Port Royal Road, Springfield, VA 22161				
12a. DISTRIBUTION / AVAILABILITY STATEMENT Approved for public release; distribution is unlimited.			12b. DISTRIBUTION CODE	
13. ABSTRACT (Maximum 200 words) The U.S. Army Corps of Engineers (USACE) has been assessing the potential environmental and economic benefits of replacing greased or oiled bushings with greaseless (self-lubricated) bushings at its hydropower and navigation facilities. Products of this type currently on the market, however, were not specifically developed for the high-load, low-speed oscillating operating conditions typical for power-generation machinery. In-place testing of these materials on real-world hydroelectric equipment would pose too much risk of failure for critical facilities, and require many years to obtain meaningful performance comparisons. No standard specifications or laboratory tests for such applications have yet been developed and widely accepted. The U.S. Army Construction Engineering Research Laboratory (CERL) cooperated in a joint effort between the USACE Hydroelectric Design Center (HDC; Portland, Oregon) and Powertech Laboratories Inc. (Surrey, BC, Canada) to use Powertech's equipment and the combined hydroelectric expertise of HDC and Powertech Laboratories to develop standardized test procedures and a rating system for greaseless bushing materials intended for oscillating operation in high-load, low-speed conditions. An objective of this work was to evaluate a series of greaseless bushing materials using the new testing regimen. This report documents the development of the testing regimen, discusses the bearing rating procedure, and summarizes the results of the materials testing program.				
14. SUBJECT TERMS hydropower plants navigation structures bushings			hydroelectric equipment maintenance and repair materials testing	15. NUMBER OF PAGES 122
				16. PRICE CODE
17. SECURITY CLASSIFICATION OF REPORT Unclassified	18. SECURITY CLASSIFICATION OF THIS PAGE Unclassified	19. SECURITY CLASSIFICATION OF ABSTRACT Unclassified	20. LIMITATION OF ABSTRACT SAR	