



**US Army Corps
of Engineers**

Construction Engineering
Research Laboratory

USACERL Technical Report M-91/08

July 1991

Modernization of Existing Underground Heat Distribution Systems

Causes and Control of Corrosion in Buried-Conduit Heat Distribution Systems

by

James R. Myers
Ellen G. Segan
Charles P. Marsh
Vincent F. Hock

Heat distribution systems using buried conduit are extremely vulnerable to premature failure due to corrosion. The objective of this work was to evaluate the causes and determine methods of controlling corrosion in these systems.

Heat distribution systems at several military installations were studied to identify common corrosion problems. This research indicated that corrosion can be mitigated by (1) reducing the amounts of dissolved carbon dioxide and oxygen in the products carried by the system, (2) keeping the insulation between the carrier pipe and the conduit dry and developing specifications that limit the amounts of leachable aggressive species in insulation, (3) using properly designed cathodic protection systems, and (4) using properly selected and applied surface coatings.

The contents of this report are not to be used for advertising, publication, or promotional purposes. Citation of trade names does not constitute an official indorsement or approval of the use of such commercial products. The findings of this report are not to be construed as an official Department of the Army position, unless so designated by other authorized documents.

DESTROY THIS REPORT WHEN IT IS NO LONGER NEEDED

DO NOT RETURN IT TO THE ORIGINATOR

FOREWORD

This research was performed for the Directorate of Military Programs, Headquarters, U.S. Army Corps of Engineers (HQUSACE) under Project 4A162781AT45, "Energy and Energy Conservation Strategy"; Technical Area B, "Installation Energy Conservation Strategy"; Work Unit 011, "Modernization of Existing Underground Heat Distribution Systems." The HQUSACE Technical Monitor was Mr. Dale Otterness, CEMP-~~EE-E~~. *ET*

The research was performed by the Engineering and Materials Division (EM) of the U.S. Army Construction Engineering Research Laboratory (USACERL). Part of the work was performed under contract by Mr. James R. Myers of JRM Associates, Franklin, OH. Dr. Paul A. Howdysshell is Chief, USACERL-EM. The technical editor was Gloria J. Wienke, USACERL Information Management Office.

COL Everett R. Thomas is Commander and Director of USACERL and Dr. L.R. Shaffer is Technical Director.

CONTENTS

	Page
SF 298	1
FOREWORD	2
LIST OF TABLES AND FIGURES	4
1 INTRODUCTION	7
Background	
Objectives	
Approach	
Mode of Technology Transfer	
2 CORROSION PROCESSES AND MITIGATION	8
Corrosion of Carrier Pipes by the Products Conveyed	
Corrosion of Carrier Pipes and Conduits by Insulation-Related Leachates	
Corrosion of Conduits by Soil	
3 CATHODIC PROTECTION AND ELECTRICAL CONTINUITY	22
4 COATINGS FOR SOIL-SIDE CORROSION MITIGATION	30
Coal Tar Enamels	
Coal Tar Epoxies	
Fusion-Bonded Epoxies	
5 CONCLUSIONS AND RECOMMENDATIONS	35
Conclusions	
Recommendations	
METRIC CONVERSION TABLE	36
REFERENCES	36
DISTRIBUTION	

TABLES

Number		Page
1	Chemical Treatments That Can Mitigate Corrosion in Hot-Water Heating Systems	9
2	Anticipated Corrosion Behavior of Steel in Soils of Varying Resistivity	13
3	Preferred Materials for Electrically Isolating Gaskets	27
4	Satisfactory Materials for Electrically Isolating Gaskets	28
5	Typical Physical Properties for Nonasbestos Materials	29

FIGURES

1	Conduit Without Protective Covers	10
2	Thermal Insulation Exposed to Rain and Condensation	10
3	Corroded Carrier Pipe from a Concrete Trench	11
4	Schematic Diagram of Conduit for Building 238, Pease AFB, NH	16
5	Schematic Diagram of Conduit for Building 241, Pease AFB, NH	17
6	Schematic Diagram of Conduit for the Recreation Center, Pease AFB, NH	18
7	Schematic Diagram of Conduit for Building 239, Pease AFB, NH	19
8	Schematic Diagram of Conduit for the Chapel at Hill AFB, UT	20
9	Schematic Diagram of Conduit for the Occupational Medicine Building at Hill AFB, UT	21
10	Schematic Diagram of Conduit Penetrating a Concrete Wall Foundation	23
11	Schematic Diagram Showing Representative Concrete Wall/Foundation Penetration for Buried-Conduit-Type Heat-Distribution System	24

FIGURES (Cont'd)

Number		Page
12	A Gasket That Failed Due to Unevenly Loaded Bolts	25
13	Damage to the Bitumen Coating Was Present Before Installation	31
14	Effect of Immersion Time on the Amount of Water Absorbed by Selected Coatings for Steel in Underground Environments	33
15	Effect of Immersion Time on the Electrical Resistance of Selected Coatings for Steel in Underground Environments	34

CAUSES AND CONTROL OF CORROSION IN BURIED-CONDUIT HEAT DISTRIBUTION SYSTEMS

1 INTRODUCTION

Background

It has been estimated that the U.S. Army owns more than 2000 miles of heat distribution systems.* The systems that use buried steel conduit are extremely vulnerable to premature failure¹ due to corrosion because they contain four surfaces that can be exposed to aggressive environments. The inside surface of carrier pipes can be corroded by the products conveyed; the outside surface of the carrier pipes and the inside surface of the steel conduits/casings can be corroded by aggressive, aqueous solutions leached from the insulation; and the outside surface of the steel conduits can be corroded by aggressive soils. To combat premature failure, installation and maintenance personnel need information about the causes and methods of controlling corrosion in buried-conduit heat distribution systems.

Objectives

The objectives of this report are to provide information regarding (1) corrosion in buried-conduit heat distribution systems, (2) how to practically mitigate this corrosion, and (3) what must be done to prevent future premature failures.

Approach

Heat distribution systems at several military installations were studied to identify common corrosion problems. The causes of corrosion in buried steel conduit were determined using failure analysis procedures. Available materials and procedures were then evaluated to determine appropriate corrosion control methods for use in aggressive environments.

Mode of Technology Transfer

It is recommended that information from this study be included in the revisions of Corps of Engineers Guide Specifications (CEGS)-15705, *Underground Heat Distribution System and Condensate Return System* (Prefabricated or Pre-Engineered Types) and CEGS-15709, *Heat Distribution Systems Outside of Buildings: (Concrete Shallow Trench Systems)*.

* For comparison, it is estimated that the Department of Defense owns and operates over 6000 miles of heat distribution systems. A metric conversion table is presented on page 36.

¹ E.G. Segan and C-P. Chen, *Investigation of Tri-Service Heat Distribution Systems*, Technical Report M-347/ADA145181 (U.S. Army Construction Engineering Research Laboratory [USACERL], June 1984).

2 CORROSION PROCESSES AND MITIGATION

Corrosion of Carrier Pipes by the Products Conveyed

Serious general corrosion and pitting can occur inside carbon steel carrier pipes that convey steam condensate containing deleterious amounts of dissolved carbon dioxide and/or dissolved oxygen.² According to the results of a recent study,³ the corrosion rate (in mils per year [mpy]) for carbon steel condensate return lines can be estimated using the following expression:

$$CR = 3.7(\text{CO}_2 \times v)^{0.6} + 8.6(\text{O}_2 - 0.4)^{0.9} \quad [\text{Eq 1}]$$

where CO_2 = the dissolved carbon dioxide content of the condensate in parts per million (ppm) by weight

v = the condensate flow rate in feet per minute (fpm)

O_2 = the dissolved oxygen content of the condensate in ppm.

Examination of Equation 1 clearly establishes that the corrosion of carbon steel, steam condensate return lines can be effectively mitigated by reducing the amounts of dissolved carbon dioxide and dissolved oxygen in the products conveyed. For example, oxygen can be minimized, in part, by maintaining a proper amount of oxygen scavenger (e.g., sodium sulfite) in the boiler water and by performing routine maintenance on the pumps and valves on the condensate line. Dissolved carbon dioxide in the condensate can be minimized, in part, by avoiding the use of high bicarbonate-alkalinity feedwater and by routinely maintaining a proper amount of volatile amine(s) in the boiler water.

The hot water conveyed by "closed" heating systems can be aggressive to carbon steel pipes and copper/copper alloy heat exchanger components. This is understandable because these systems are almost never completely closed. Dissolved oxygen can exist occasionally in the hot water. Corrosion in closed hot-water systems can be effectively mitigated by chemically treating the water. Chemical water treatments performed continuously have successfully reduced corrosion in low-temperature hot-water (LTHW) systems (i.e., those that operate below 250 °F with a maximum water pressure of 30 pounds per square inch [psi]), medium-temperature hot-water (MTHW) systems (i.e., those that operate at 250 to 350 °F with pressures above 30 psi), and high-temperature hot-water (HTHW) systems (i.e., those that operate above 350 °F and 135 psi).⁴ The treatments are summarized in Table 1.

Similarly, chilled waters conveyed by closed systems can be chemically treated for corrosion control by maintaining a proper amount of sodium nitrite-borax inhibitor and a copper/copper alloy inhibitor.⁵

² R.B. Masse, "Steam Condensate Corrosion," *Materials Protection*, Vol 5, No. 7 (July 1966), pp 37-39; J.J. Macguire, "After Boiler Corrosion," *Industrial and Engineering Chemistry*, Vol 46, No. 5 (May 1954), pp 994-997; L.F. Collins, "Corrosion of Steam Condensate Lines," *Corrosion Handbook*, H.H. Uhlig, ed. (John Wiley and Sons, Inc., 1948), pp 538-545.

³ J.R. Myers, "Corrosion of Steel, Steam-Condensate Return Lines by the Products Conveyed," prepared for USACERL under Purchase Order No. DACA88-86-M-1058, 22 August 1986.

⁴ R.T. Blake, *Water Treatment for HVAC and Potable Water Systems* (McGraw-Hill, 1980), pp 146-149.

⁵ R.T. Blake.

Table 1

Chemical Treatments That Can Mitigate Corrosion in Hot-Water Heating Systems

<u>System</u>	<u>Chemical Treatment</u>
Low-temperature	Sodium molybdate inhibition or sodium nitrite-borax containing a copper/copper alloy inhibitor such as mercaptobenzo-thiazole (MBT).
Medium-temperature	An oxygen scavenger such as sodium sulfite with the pH adjusted to 9 to 10 using caustic soda.
High-temperature	Same as that for medium-temperature.

*Source: R.T. Blake, *Water Treatment for HVAC and Potable Water Systems* (McGraw-Hill, 1980). Used by permission of the author.

Corrosion of Carrier Pipes and Conduits by Insulation-Related Leachates

Although moisture/water should not normally exist in the annuli between the carrier pipes and the conduits, wet insulation is a relatively common occurrence in Army heat distribution systems. A number of sources can contribute to wet insulation, including: (1) rain/condensation absorbed by the insulation during unprotected storage before installation (Figures 1 and 2), (2) leaks in conduit joints that allow groundwater to collect inside the annuli, (3) leaks in the carrier pipes that allow the conveyed product to collect in the annuli, and (4) leaks in the conduits (caused by the aggressive soils) that allow groundwater to collect in the annuli. Although soil-side coatings over a weld defect/leak can initially support a 15 psi pressure test,⁵ subsequent coating deterioration at the site can allow groundwater to ingress into the annuli containing the insulation.

Moisture/water in the annuli between the carrier pipes and the conduits can cause leaching of aggressive species from certain insulations.⁶ Further, moisture in the insulation can significantly reduce the effectiveness of the insulation; moisture at the insulation-carrier pipe interfaces can be converted to steam that will, in turn, destroy the desired intimate contact between the two.

⁵ Personal communication, Robert Couch, Entertec, Inc., Brecksville, Ohio.

⁶ E.G. Segan, E.W. Blackmon, and C. Marsh, *The Effects of Minor Constituents in Calcium Silicate Insulation on the Corrosion of Underground Heat Distribution Systems*, Technical Report M-346/ADA143378 (USACERL, June 1984); J.F. Delahunt, "Corrosion Control Under Thermal Insulation and Fire Proofing," *Bulletin of the Institution of Corrosion Science and Technology*, Vol 20, No. 2 (May 1982), pp 2-7; J.D. Nicholson, "Application of Thermal Insulation of Stainless Steel Surfaces," *Bulletin of the Institution of Corrosion Science and Technology*, Vol 19, No. 5 (October 1981), pp 2-5; P. Lazar, III, "Factors Affecting Corrosion of Carbon Steel Under Thermal Insulation," *Corrosion of Metals Under Thermal Insulation*, W.I. Pollock and J.M. Barnhart, eds. (American Society for Testing and Materials [ASTM], 1985), pp 11-26.



Figure 1. Conduit without protective covers.



Figure 2. Thermal insulation exposed to rain and condensation.

Briefly, chlorides and sulfates leached from insulation can create aqueous environments that are aggressive to carbon steel.⁷ The damage caused by chloride is a special concern because most common insulation (e.g., magnesia, calcium silicate, nitrile rubber, and foamed plastics such as polyurethane and phenolic) nominally contain 10 to 500 ppm soluble chloride.⁸ Further, insulation can also become contaminated with chlorides during storage or when installed at coastal locations where the atmosphere contains chloride. Chlorides not directly associated with the insulation can also corrode carrier pipes placed in concrete ducts and trenches (Figure 3), especially in areas where salt (calcium and/or sodium chlorides) is used for snow/ice removal.

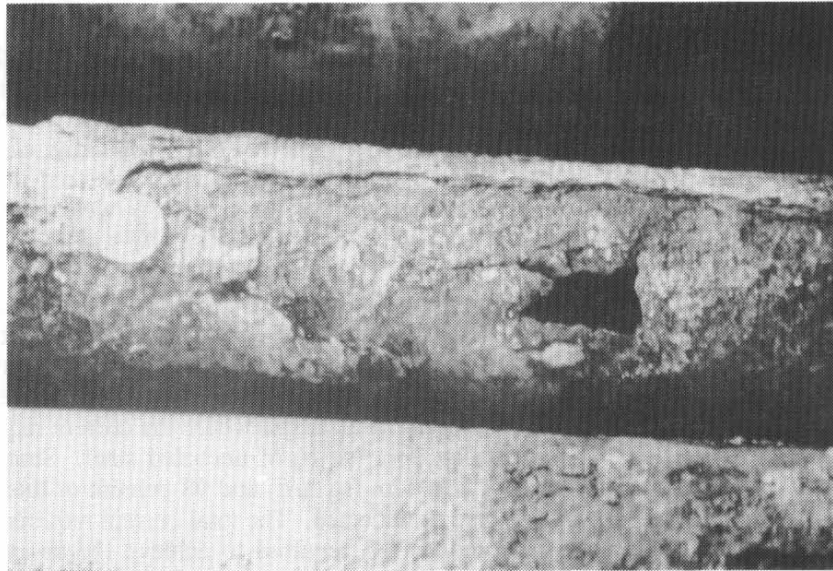

Figure 3. Corroded carrier pipe from a concrete trench. (Magnification: 0.6X)

⁷ M.F. Obrecht, and J.R. Myers, "Potable Water Systems in Buildings: Deposit and Corrosion Problems," *Heating/Piping/Air Conditioning*, Vol 45, No. 5 (May 1973), pp 77-83.

⁸ J.D. Nicholson.

Corrosion of the outside surfaces of carrier pipes and the inside surfaces of the conduits that are associated with the insulation can be minimized by a number of techniques, including: (1) regular inspection and maintenance to ensure that the insulation is dry, (2) consultations between the system designers, insulation contractors, and system operators during the design stage to ensure that a suitable specification is developed for the total system, and (3) cooperation between all contractors during installation to ensure that the system design requirements are satisfied. Most important, specifications that limit deleterious amounts of leachable aggressive species in insulation should be developed. West Germany has developed a standard thermal insulation used in conjunction with copper-tube carriers. German Draft Standard DIN 1988, *Part 8 - Technical Rules for Drinking Water Installations; Avoidance of Corrosion Damage and Incrustation* states: "Heat insulation materials for copper pipes must be free of nitrite and must not contain more than 0.2% by weight ammonia."⁹ Similar limits could be established for chlorides and sulfates. Limiting chlorides would not reduce the availability of insulation because manufactured insulation free of chlorides (e.g., cellular glasses) is currently available.

Although coating the outside surfaces of the carrier pipes and the interior surfaces of the conduits may be helpful, it is doubtful that a continuous coating (free of defects or "holidays") could be cost-effectively achieved at all locations, especially at the field-weld locations.

Corrosion of Conduits by Soil

The data in Table 2 clearly establish that soils having resistivities less than about 10,000 ohm-centimeter (ohm-cm) are corrosive to carbon steel.¹⁰ The exterior surfaces of conduits contacting these soils should be coated; cathodic protection should be installed to protect the steel exposed at holidays. Coatings and cathodic protection may also be required for soils having resistivities greater than about 30,000 ohm-cm.

The most practical and cost-effective means of cathodically protecting the soil-side surface of coated conduits associated with heat distribution systems is through the use of sacrificial anodes. Impressed-current cathodic protection systems are normally not recommended for this application primarily because of the possibility of causing stray-current corrosion (i.e., interference). Typically, cathodic protection is achieved using magnesium-alloy anodes. Zinc anodes should not be considered unless the soil has a resistivity of less than about 2000 ohm-cm or the conduits are unusually well coated (i.e., 98 percent coating efficiency) and the current required for protection is exceptionally small.

Sacrificial-anode cathodic protection systems for conduits can be readily designed using standard industry procedures¹¹ providing the soil resistivity (ρ) and the current required for protection are known and the conduits are electrically isolated from other underground metallic structures. For example, consider a well-coated (i.e., 98 percent coating efficiency), 1000-ft long, 12-in. diameter (nominal size), carbon steel conduit that is buried in 9000 ohm-cm, neutral soil where the current required for protection is known to be 2 milliamperes (mA) per square foot (sq ft) of uncoated steel. Since a 12-in. diameter conduit has an area of 3.34 square feet per linear foot (sq ft/ft) and 98 percent of this is protected by the coating, 66.8 sq ft of conduit is essentially bare or uncoated. The total current required to protect the bare steel would be 134 mA. The number of anodes (N) required to achieve the desired current flow for cathodic protection (i.e., a polarized potential of -0.85 volt referenced to a copper-copper sulfate electrode) in 9000 ohm-cm soil can be determined using Equation 2.

⁹ E. Mattsson, "Focus on Copper in Modern Corrosion Research," *Materials Performance*, Vol 26, No. 4 (April, 1987), pp 9-16.

¹⁰ J.R. Myers, and M.A. Aimone, *Corrosion Control for Underground Steel Pipelines: A Treatise on Cathodic Protection* (JRM Associates, 1976).

¹¹ J.R. Myers and M.A. Aimone.

Table 2

Anticipated Corrosion Behavior of Steel in Soils of Varying Resistivity^a

<u>Resistivity Range</u> <u>ohm-cm</u>	<u>Classification</u>	<u>Life</u> <u>Expectancy (years)</u>
<u>AFM 88-9^b</u>		
0 - 2,000	Corrosion Activity	-
2,000 - 10,000	Severe	-
10,000 - 30,000	Moderate	-
10,000 - >30,000	Mild	-
	Unlikely	-
<u>Senatoroff^c</u>		
0 - 749	Corrosion Activity	-
750 - 2,599	Extremely Corrosive	-
2,600 - 9,999	Corrosive	-
>10,000	Moderately Corrosive	-
	Noncorrosive	-
<u>Ewing^d</u>		
0 - 2,000	Corrosion Activity	
2,000 - 4,500	Bad	0 - 10
4,500 - 6,000	Fair	10 - 17
6,000 - 10,000	Good	17 - 25
	Excellent	25
<u>Romanoff^e</u>		
>700	Corrosion Classification	
700 - 2,000	Very Corrosive	
2,000 - 5,000	Corrosive	-
- >5,000	Moderately Corrosive	-
	Mildly to Noncorrosive	-
<u>Husock^f</u>		
>1,000	Soil Resistivity	
1,000 - 5,000	Very Low	Possibly 5 years ^g
5,000 - 10,000	Low	Possibly 10 years ^g
>10,000	Medium	Difficult to Predict
	High	Depends upon Homogeneity of soil
<u>Atkinson^h</u>		
0 - 1,000	Corrosivity	
1,000 - 10,000	Probably Severe	-
10,000 - 100,000	Moderate to Severe	-
> 100,000	Mild, if Aerated	-
	Probably not Corrosive	-

^a Source: J.R. Myers and M.A. Aimone, *Corrosion Control for Underground Steel Pipe-Lines: A Treatise on Cathodic Protection* (JRM Associates, 1976).

^b Air Force Manual (AFM) 88-9, *Corrosion Control* (Headquarters, U.S. Air Force, 1 August 1964).

^c N.K. Senatoroff, "Experiences of the Southern Counties Gas Company of California," *Journal of the American Water Works Association*, Vol 43 (1951), pp 1017-1020.

^d S.P. Ewing, *Soil Corrosion and Pipe Line Protections* (American Gas Association, 1938).

^e M. Romanoff, "Results of National Bureau of Standards Corrosion Investigations in Disturbed and Undisturbed Soils," *Proceedings of the Fourteenth Annual Appalachian Underground Corrosion Short Course* (Gulf Publishing Company, 1969), pp 433-456.

^f Personal Communication, B. Husock, Harco Corp., 1970.

^g Does not infer that the structure would be corroded beyond repair, but rather that it would be fortunate if no corrosion failures occurred in this time period.

^h T.R. Atkinson, "Corrosion and Protection of Buried Pipelines: Preparation for Cathodic Protection," *Bulletin of the Institution of Corrosion Technology*, No. 47 (October, 1974), pp 1-10.

$$N = I_{req}/i \quad [Eq 2]$$

where I_{req} = total current required

i = the current output of a single anode.

The current output of a single anode can be calculated using the following expression:

$$i = CfyA/p \quad [Eq 3]$$

where C = an anode/structure-related "constant" (e.g., 120,000 for a high-potential, magnesium-alloy anode attached to a coated structure; 96,000 for a standard-potential, magnesium-alloy anode attached to a coated structure)

y = a current output factor for an anticipated structure-to-soil potential (e.g., one/unity for a protection potential of -0.85 volt referenced to copper-copper sulfate),

f = a current output factor for the anode selected (e.g., one/unity for a packaged, 17-lb, magnesium-alloy anode; 1.06 for a packaged, 32-lb, magnesium-alloy anode)

A = an anode paralleling factor (e.g., assumed to be one/unity for anodes spaced more than about 25 ft apart along a conduit)

p = the soil resistivity in ohm-cm.

If packaged, 17-lb, high-potential, magnesium-alloy anodes were used for the project, 10 anodes would be required [$N = (134)(9000)/120,000 = 10$]. The desired cathodic protection would be achieved by properly installing a 17-lb, packaged, high-potential, magnesium-alloy anode 50 ft from one end of the conduit and the remaining anodes at subsequent 100-ft intervals. The anticipated life expectancy of this cathodic protection system can be readily determined using the following expression:

$$L_{Mg} = 49.3W/i \quad [Eq 4]$$

where L_{Mg} = the useful anode life in years

W = the anode weight in pounds

i = the current output of the anode in milliamperes.

Since a 17-lb, packaged, high-potential, magnesium-alloy anode in 9000 ohm-cm soil will produce 13.3 mA, the anticipated life expectancy of the cathodic protection system should be about 63 years [$L_{Mg} = (49.3)(17)/13.3 = 63$].

Similarly, it can be shown that 13 packaged, 17-lb, standard-potential, magnesium-alloy anodes would be required to achieve the same protection. The anticipated life expectancy of the cathodic protection system using these anodes would be about 78 years.

From this brief discussion, it is evident that cathodic protection systems must be individually designed. A cathodic protection system cannot be expected to achieve its intended objective when the design procedure is based on the assumptions that 100 to 150 ft of 12- to 14-in. diameter, asphaltic-coated, steel conduit require a cathodic protection current of 15 to 25 mA, and 100 to 150 ft of 12- to 14-in. diameter, "epoxy-coated," steel conduit require a cathodic protection current of 3 to 5 mA. This approach to cathodic protection design (which is, in fact, used by one manufacturer of prefabricated, insulated piping systems) would probably be acceptable under some conditions, but not all. For example, if the current required for protection is 2 mA per square foot of uncoated steel and the conduit is 98 percent coated with an asphaltic product, the procedure would be reasonable. It would not be reasonable if significant coating damage occurred during shipment and installation of the conduit and/or the conduit was installed in soil which supports sulfate-reducing-bacteria (SRB) activity where the current required for protection could be as high as 42 mA per square foot of uncoated steel conduit.¹²

Even properly designed and installed cathodic protection systems cannot be expected to inhibit corrosion when the conduits are electrically continuous (shorted) with other underground, metallic structures that are not intended to be protected. Under these conditions, the electrical short causes the sacrificial anodes to produce more current but provide less (usually inadequate) protection to the desired structure.

The effectiveness of an installed/existing cathodic protection system can be evaluated using structure-to-soil (or pipe-to-soil [P/S]) potential measurements. For steel and other ferrous-base materials (including stainless steels and ductile iron), a polarized P/S potential of -0.85 volt referenced to a copper-copper sulfate electrode is the criterion for adequate protection. A P/S potential equal to or more negative than -0.85 volt indicates adequate protection. A P/S potential more positive than -0.85 volt indicates either partial protection or no protection at all (depending on its value). It is important during P/S potential tests that a properly calibrated reference electrode be placed in the soil immediately above the underground structure; the potentials must be measured using a high-resistance volt meter. Meaningful P/S potentials cannot be measured for the underlying structure by placing the reference electrode on slab concrete or asphalt.

During this investigation, P/S potential data were collected for the conduits associated with four recently installed heat distribution systems at Pease Air Force Base (AFB), NH, and two systems at Hill AFB, UT. All six of these systems had been specified to be designed and installed in accordance with Corps of Engineers Guide Specification CEGS-15705, dated August 1984. Schematics showing the conduit sizes and location for these six systems are given in Figures 4 through 9 where the negative numbers along the underground portions of the conduits are the measured P/S potentials. Not unexpectedly, only one of the six buried-conduit systems appeared to be adequately protected and even this one (Figure 9) may not be completely protected since P/S potentials were not measured where the conduit was covered by pavement. The somewhat unusually less negative P/S potentials (i.e., -0.31 to -0.32 volt as referenced to a Cu/CuSO₄ half cell) recorded for the 8-in. diameter conduit near Building 238 at Pease AFB (Figure 4) indicated that it was shorted to either underground copper or steel reinforcements in concrete. Subsequent indepth examination indicated that the conduit was shorted to both. Determining exactly why the other four conduit systems were not adequately cathodically protected was beyond the scope of the investigation. However, it was determined that both of the new lines at Hill AFB are electrically isolated from other underground metallic structures.

¹² J.R. Myers and M.A. Aimone.

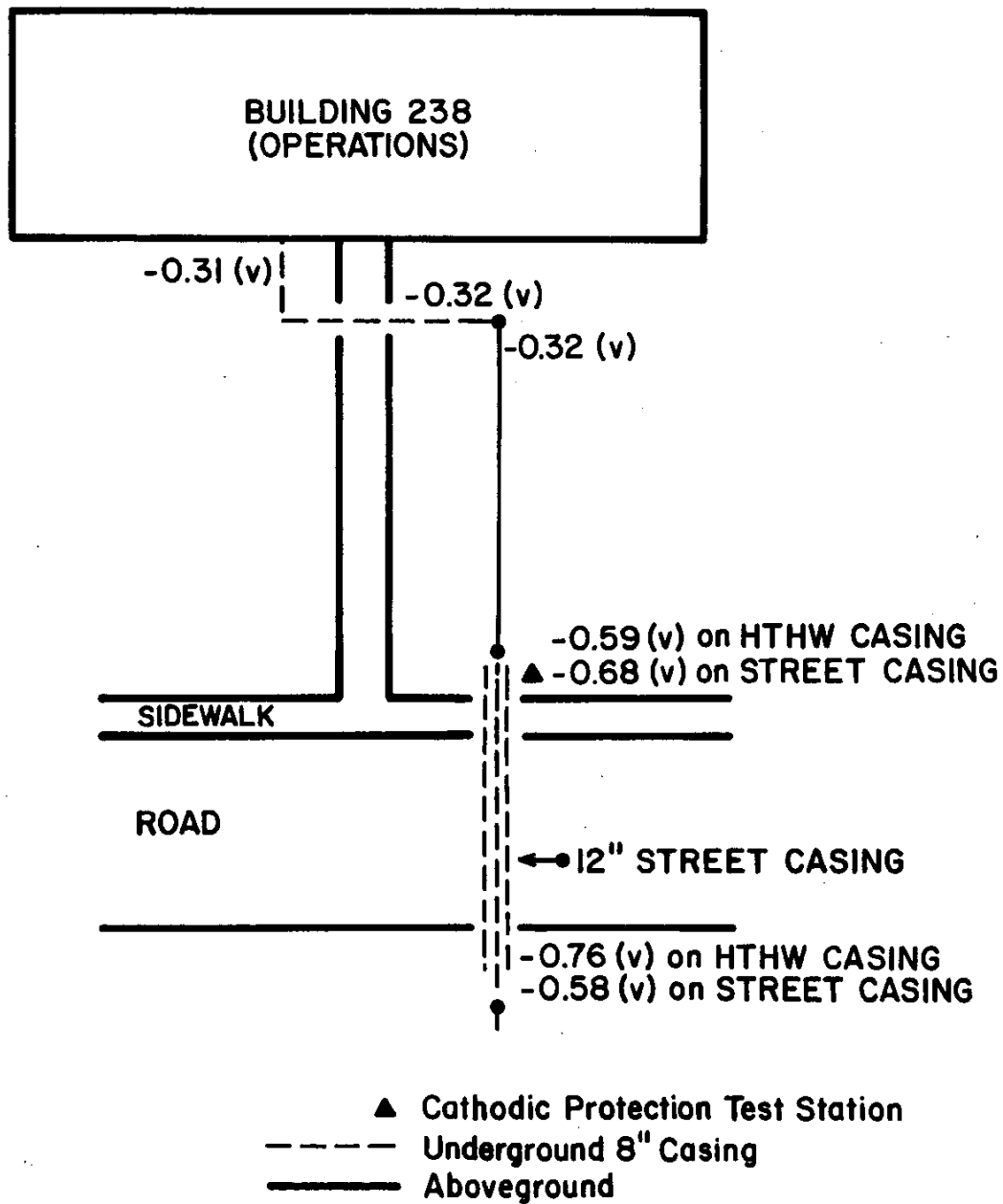

Figure 4. Schematic diagram of conduit for Building 238, Pease AFB, NH.

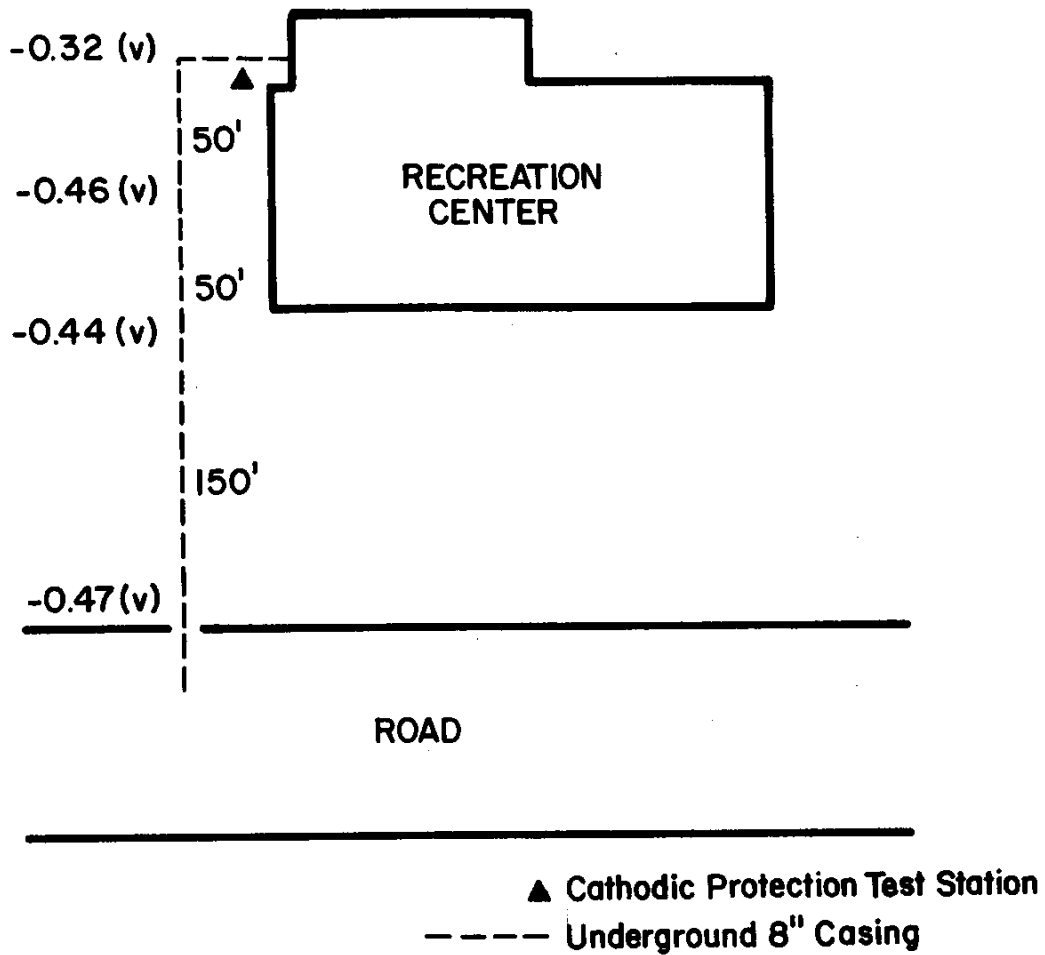

Figure 6. Schematic diagram of conduit for the Recreation Center, Pease AFB, NH.

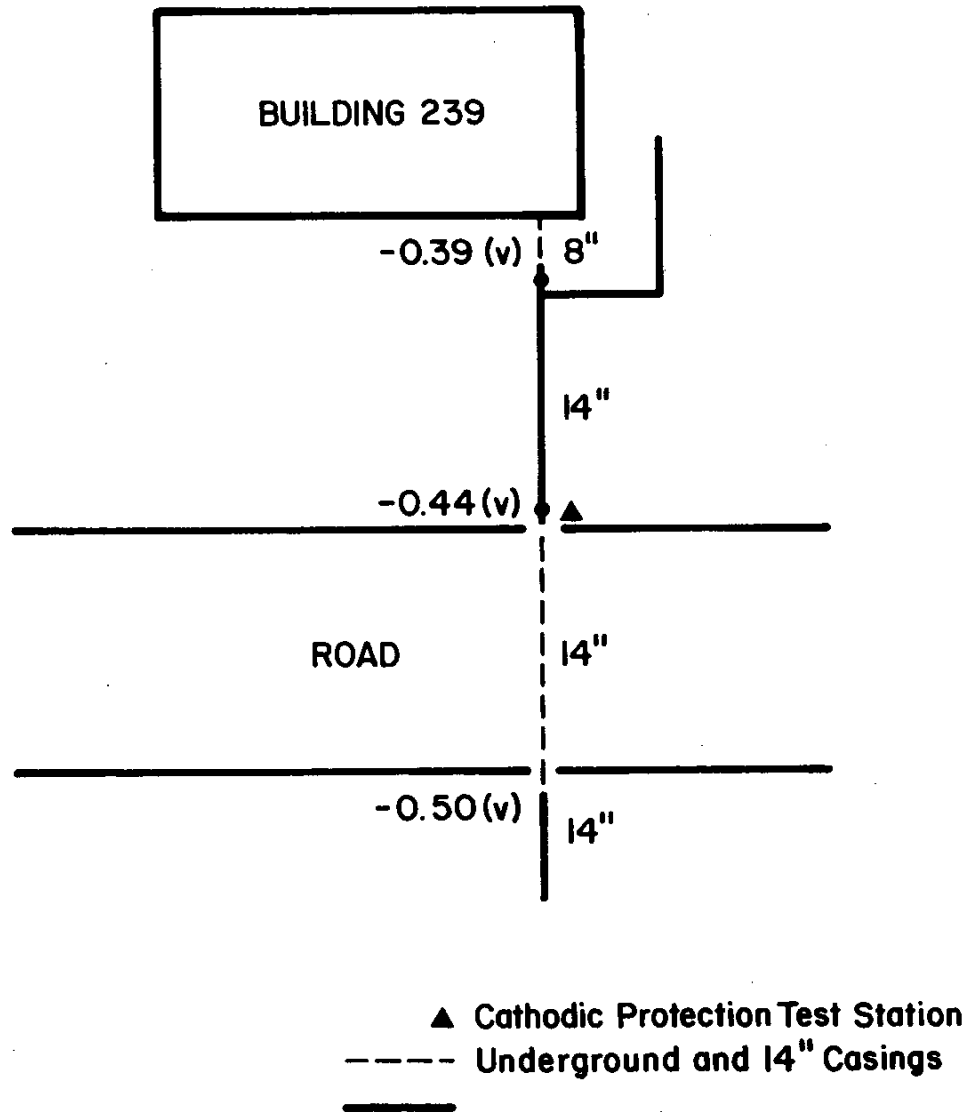

Figure 7. Schematic diagram of conduit for Building 239, Pease AFB, NH.

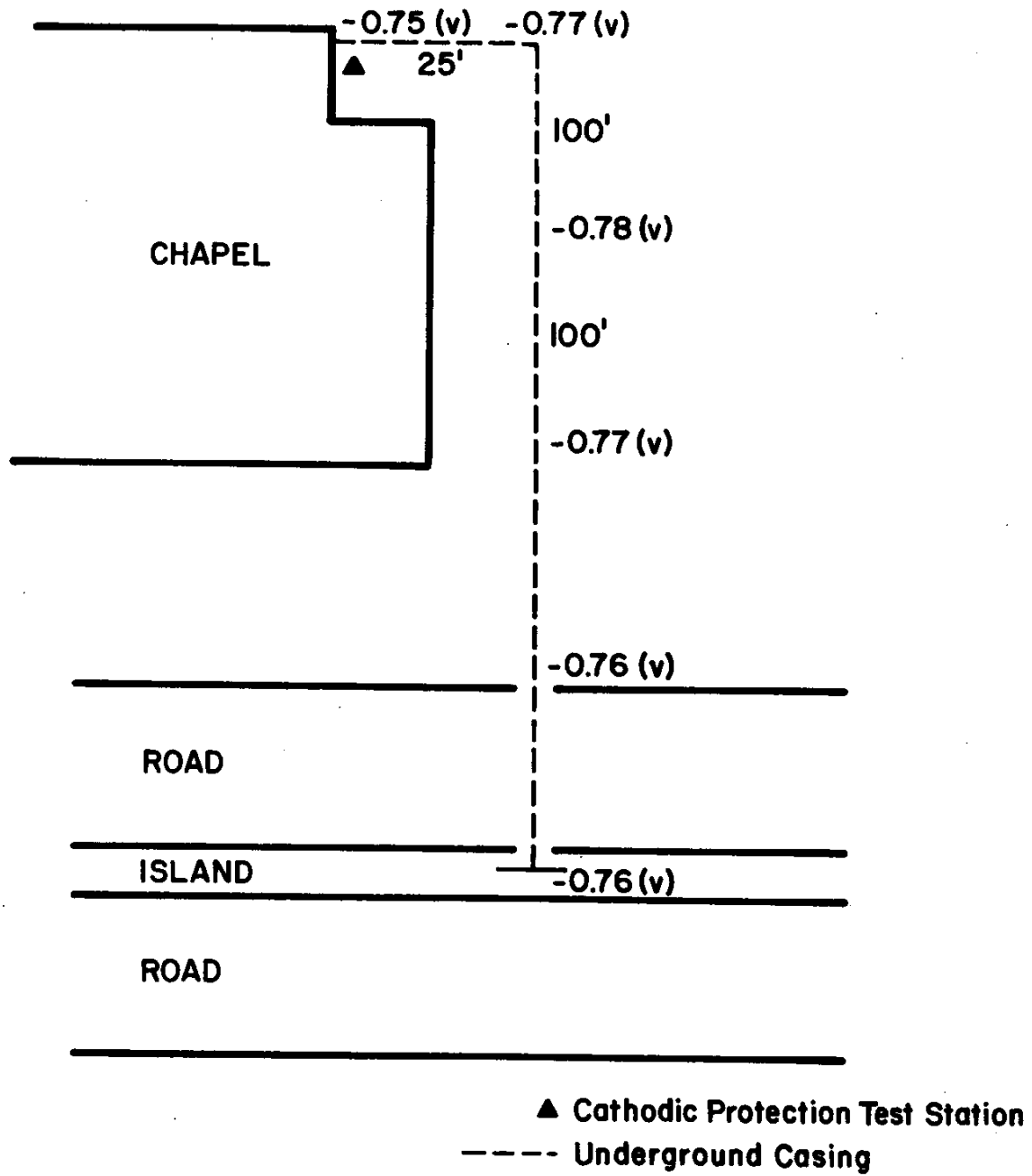

Figure 8. Schematic diagram of conduit for the Chapel at Hill AFB, UT.

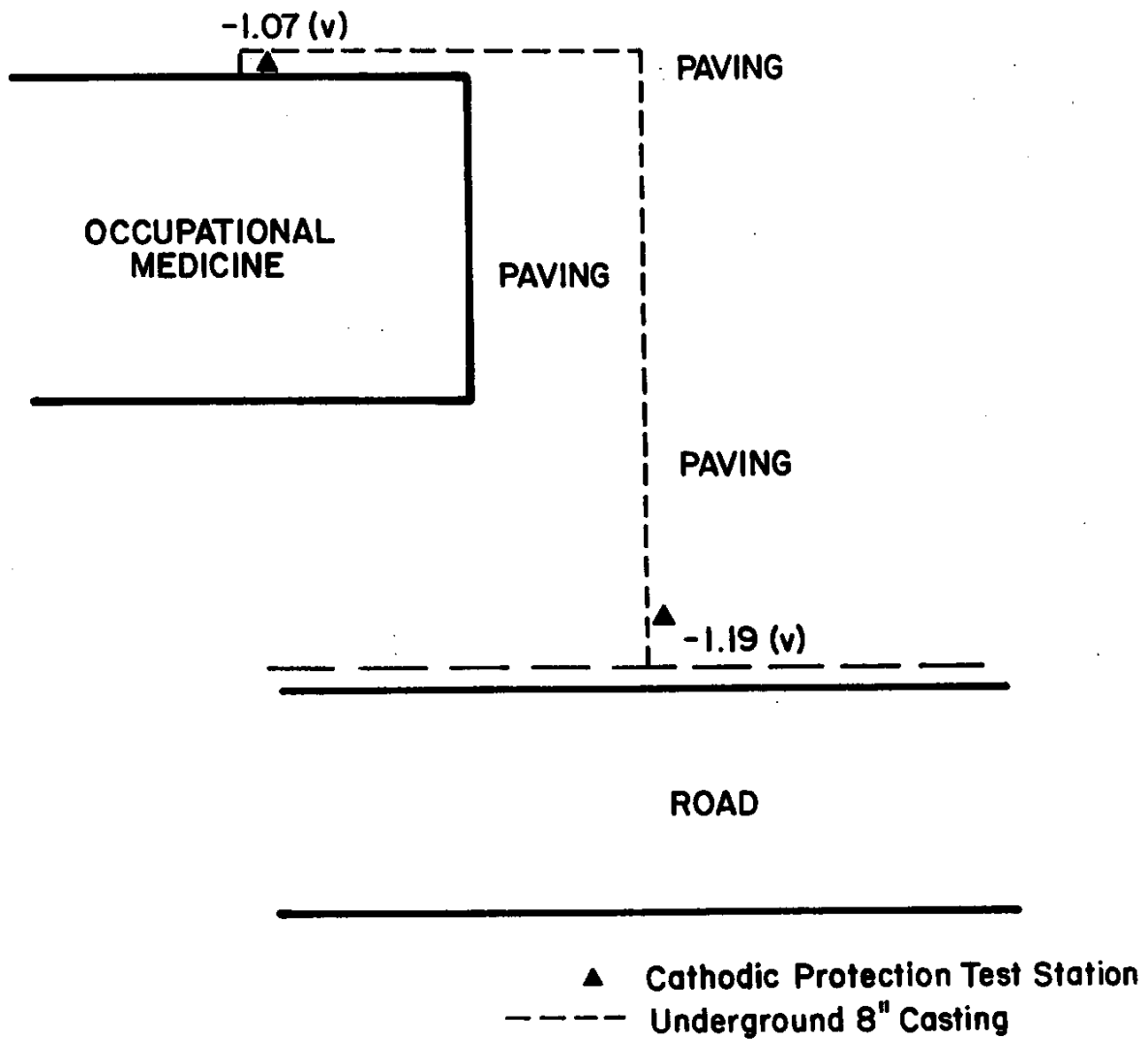

Figure 9. Schematic diagram of conduit for the Occupational Medicine Building at Hill AFB, UT.

3 CATHODIC PROTECTION AND ELECTRICAL CONTINUITY

Electrical isolation of the heat distribution system conduits can be a major concern because they are in metallic contact with the carrier pipes at conduit terminations (Figure 10).¹³ Further, supports for the carrier pipes typically make electrical contact with the conduits. This creates the need to electrically isolate the carrier pipes (e.g., by placing an isolating flange in each line) immediately after they enter the buildings and before they can contact any other metallic structure within the buildings. Examination of Figure 10 also suggests that the steel leak plates that are electrically continuous with the conduits could very well contact steel reinforcements in concrete foundations/walls, creating a short that could be of monumental magnitude. Although it is theoretically possible to avoid shorts between the conduits and the steel reinforcements in the concrete by placing insulation between the steel wall sleeves and the conduits (Figure 11),¹⁴ attempts to achieve electrical isolation by this method are not always successful (e.g., when the insulation is not properly installed or when the conduit is "cocked" in the steel wall sleeve). Rigid, nonmetallic sleeves and flexible, nonmetallic (e.g., neoprene) seals should be used where pipes penetrate concrete walls and foundation.¹⁵

Even when isolating flanges are installed immediately after the carrier pipes enter the buildings, the desired electrical isolation is not always achieved. Isolating flanges require isolating gaskets and isolating washer and sleeves for the bolts; one omission can defeat the purpose of the flange and allow the conduits to be shorted to, for example, underground water and gas lines. Further, electrical continuity can occur across an isolating flange that is misaligned during installation. Misalignment can be expected to occur when nut-tightening/torquing is used to physically align the flanges. Another problem can occur if the isolating flange is installed at a 90 °F elbow immediately after the carrier pipe enters the building. If a long run exists immediately after the elbow, expansion in the pipe run can create shear at the flange which can cause it to short. Flanges must be maintained in a stress state of compression if shorting is to be avoided. It is also possible to lose electrical isolation at an isolating flange soon after its installation because of improper maintenance following premature gasket failure. For example, gaskets frequently fail soon after their initial installation because the bolts used for the flanged connections were not long enough and/or of high enough tensile strength and/or the bolts were not evenly loaded (Figure 12). Also, the nuts on bolts must be torqued/tightened in the proper sequence/pattern¹⁶ (i.e., in accordance with the applicable code for pressure piping) and they should be retightened 1 or 2 days after the system has been at its operating temperature. Dielectric isolation effectiveness can be tested using P/S potential measurements. It is not uncommon to lose electrical isolation during the replacement of prematurely-failed gaskets at isolating flanges. Typically, poor installation practices is the major cause of premature gasket failure.

¹³ *Perma-Pipe Underground Conduit System for U.S. Military Construction* (Midwesco Enterprises, Inc., September 15, 1964), p 19.

¹⁴ *Submittal Brochure for Tri-Service Specifications: Class A Underground Heat Distribution Systems* (Durant Insulated Pipe Company, May 29, 1967), p 25.

¹⁵ J.H. Fitzgerald, "Corrosion Control for Buried Piping," *Heating/Piping/Air Conditioning*, Vol 46, No. 3 (March 1974).

¹⁶ *Engineered Gasketing Products*, Technical Brochure GSX3:1AA (Garlock Mechanical Packing Division, Colt Industries, Inc., July 1986).

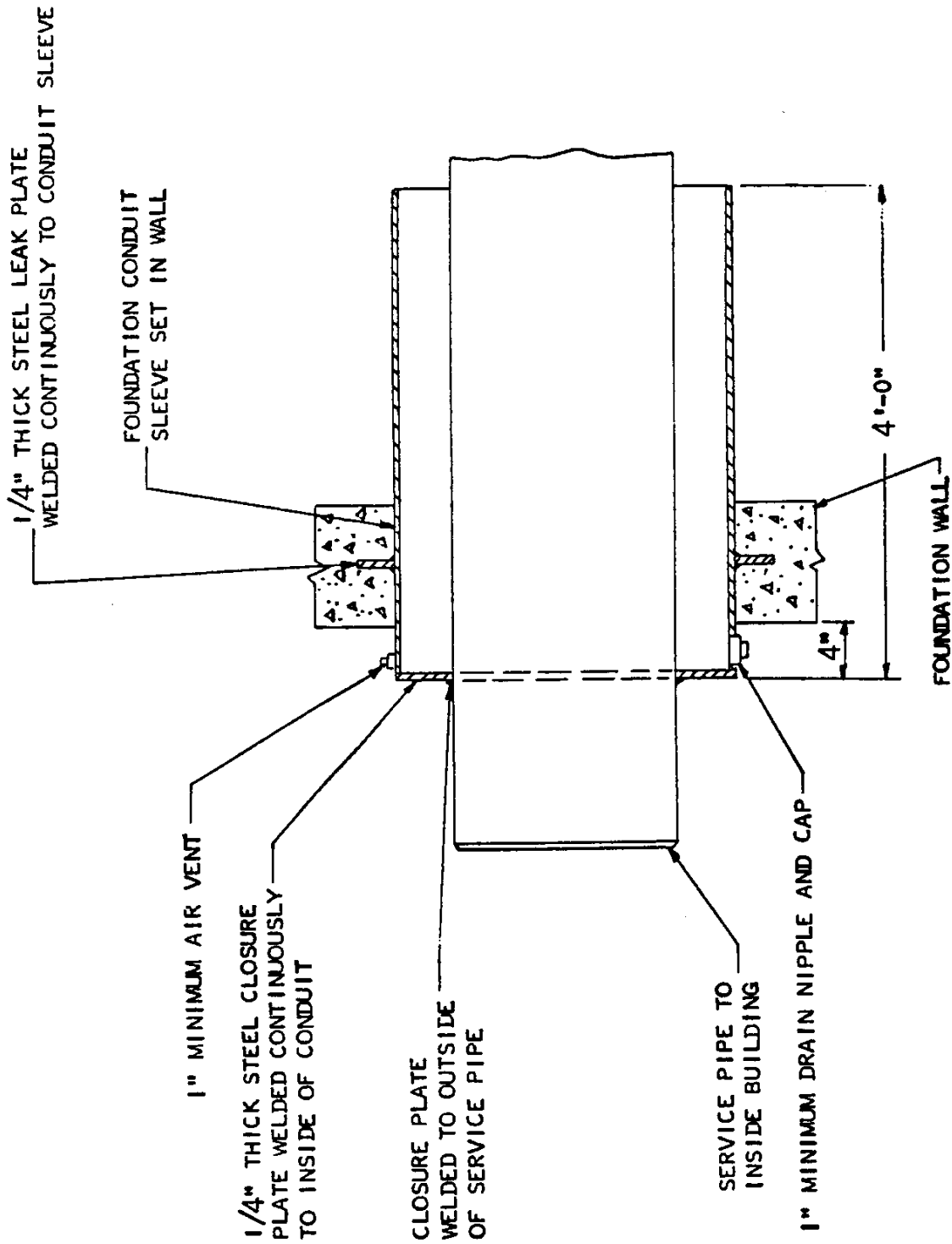

Figure 10. Schematic diagram of conduit penetrating a concrete wall foundation.
Used by permission, Midwesco Enterprises, Inc.

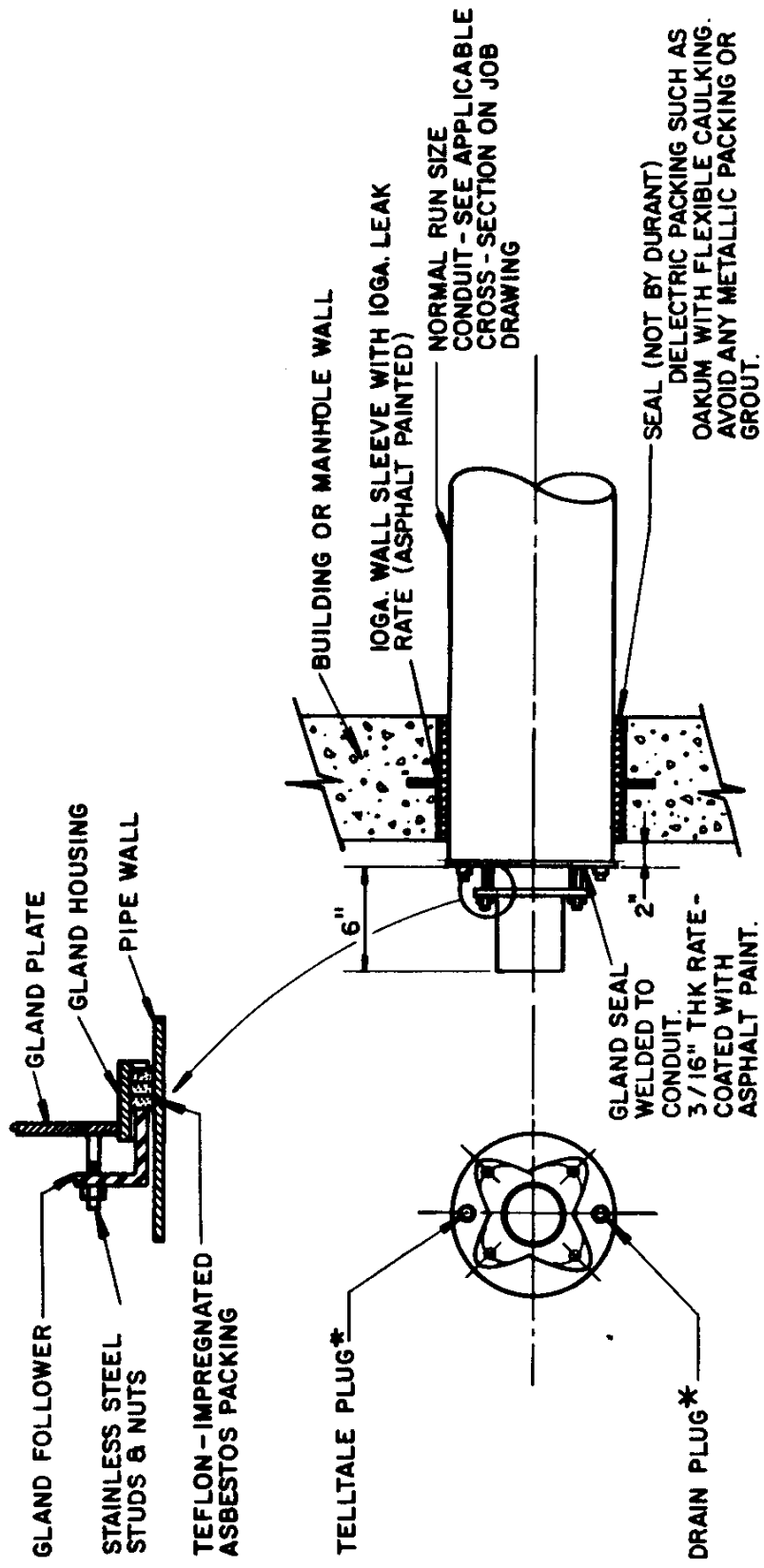

Figure 11. Schematic diagram showing representative concrete wall/foundation penetration for buried-conduit-type heat-distribution system.

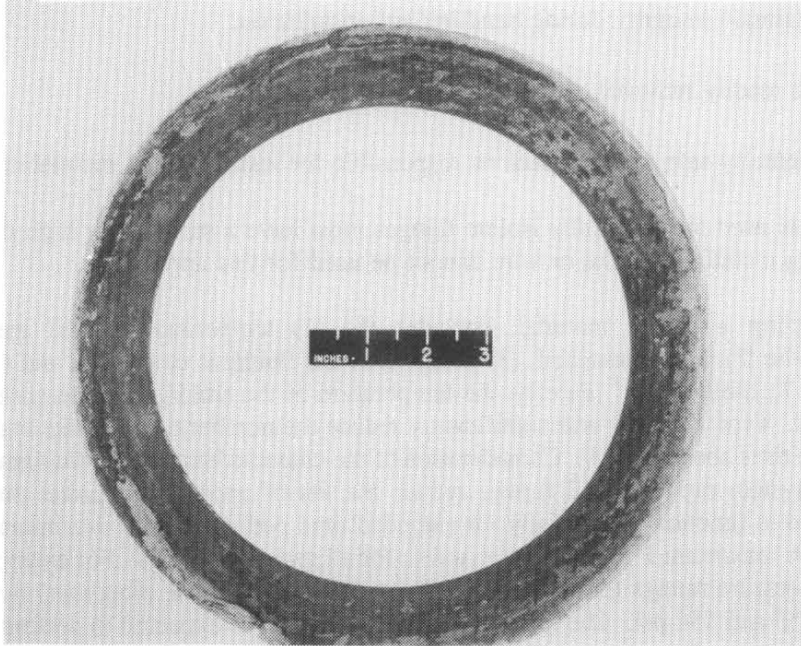

Figure 12. A gasket that failed due to unevenly loaded bolts.

A number of factors can affect the ability of a gasket to create a positive seal between two relatively stationary surfaces. Regardless of their dielectric strength, all gaskets must have the following characteristics:

- impermeability with respect to the fluid/gas contained by the system,
- chemical stability with respect to the fluid/gas contained by the system,
- sufficient deformability so as to flow into the imperfections on the seating surfaces and provide intimate contact between the gasket and these surfaces,
- thermal stability with respect to the fluid/gas contained by the system,
- sufficient resiliency so as to support an adequate portion of the applied load when joint movements are not completely eliminated by the system design,
- sufficient strength to resist crushing under the applied load and blowout under the system pressure,

- contain no products that could contaminate the fluid/gas contained by the system,
- contain no products that could cause corrosion of the seating surfaces,
- able to maintain integrity during handling and installation,
- able to be readily removed at the time of replacement, and
- environmentally safe to those persons responsible for installing and maintaining gaskets.

In addition, gaskets used to electrically isolate flanges must have a sufficiently high dielectric strength. Gaskets containing metallic graphite or wire cannot be used for this application.

When selecting a gasket material, consider the (1) temperature at the gasketed joint, (2) characteristics of the fluid/gas contained, (3) pressure of the fluid/gas contained, and (4) pressure times temperature (P X T) limitations.¹⁷ Briefly, the temperature of the fluid/gas at the gasketed joint should be considered first. Typically, this will significantly reduce the number of candidate materials, especially as the temperature rises above 200 °F. Consideration of the characteristics of the fluid/gas being conveyed and the internal system pressure will further reduce the list of appropriate gasket materials. Gaskets cannot be expected to function successfully for extended time periods at their maximum temperature and pressure ratings. A maximum P X T limitation exists for all gasket materials. For example, the maximum temperature and pressure ratings for an EPDM (ethylene propylene diene monomer) rubber material are, respectively, 300 °F and 150 psi. The material, however, cannot be expected to perform successfully for steam systems at or near these combined ratings because the material has a maximum P X T limitation of 20,000 °F-psi (i.e., 300 °F X 150 psi = 45,000 °F-psi which greatly exceeds the 20,000 °F-psi limitation).

Preferred materials for gaskets in both steam and HTHW systems are summarized in Table 3.¹⁸ Table 3 also lists the maximum service temperature and pressure for each material and its P X T limitation. Similarly, materials that are satisfactory for steam and HTHW system gaskets are summarized in Table 4. Synthetic fiber-SRB binder and synthetic fiber-EPDM binder products have a long and excellent performance record as gasket material for steam and high-temperature, hot-water systems.

Off-the-shelf isolating bolt sleeves, washers, and gaskets that can successfully perform at temperatures up to at least 450 °F and possibly 600 °F are available.¹⁹ Reportedly, the gaskets and washers are fabricated using white asbestos fibers contained in a styrene butadiene rubber (SBR) binder. The bolt sleeves are tightly wound fiberglass with a silicone rubber coating. Although a P X T limitation for the gasket material is not readily available, examination of Table 4 indicates that it could be as high as 350,000 °F-psi.

¹⁷ *Engineered Gasketing Products*.

¹⁸ *Engineered Gasketing Products*; ASME B16.21, Nonmetallic Flat Gaskets for Pipe Flanges (1978).

¹⁹ Personal Communication, R.O. Couch, Intergy, Inc., 16 June 1987.

Table 3

Preferred Materials for Electrically Isolating Gaskets^a

<u>Gasket Composition</u>	<u>Max. Service Temp., °F</u>	<u>Max. Service Pressure, psi</u>	<u>Pressure X Temperature Limitation, °F-psi^b</u>
Synthetic Fiber, SBR Binder ^c	700	1200	350,000
Synthetic Fiber, EPDM Binder ^d	700	1200	350,000
Synthetic Fiber, SBR Binder ^e	750	1800	350,000
PTFE with Inert Fillers ^f	500	800-1200 ^g	350,000

^a Source: *Engineered Gasketing Products*, Technical Brochure GSX3:1AA (Garlock Mechanical Packing Division, Colt Industries, Inc., July 1986). Used by permission.

^b Based on gasket thicknesses of 0.0625 in.; values increase marginally with thinner gaskets and decrease substantially with thicker gaskets.

^c Compressed nonasbestos product styrene butadiene rubber (SBR) binder, and aramid-group synthetic fibers (e.g., Nomex or Kevlar).

^d Compressed nonasbestos product, ethylene propylene diene monomer (EPDM) binder, and aramid-group synthetic fibers. Excellent resistance to steam.

^e Compressed asbestos product with SBR binder.

^f Polytetrafluoroethylene (PTFE) product with inert fillers such as silica (spheres) or barium sulfate.

^g Depends on the product.

Where service conditions are less stringent, isolating gaskets fabricated from nitrile butadiene (Buna-N) rubber (NBR) have been extensively and successfully used at temperatures up to about 210 °F and pressures up to about 250 psi when the product contained is water.²⁰ For steam service, silicone-formulated gaskets reportedly have been used at maximum temperatures and pressures of, respectively, 286 °F and 54 psi.²¹ The isolating bolt sleeves for both of these gasket materials are fabricated from Zytel nylon which has a maximum temperature limitation of 286 °F. Table 5 lists physical properties for nonasbestos gasketing materials.

²⁰ Personal Communication, T. Kennedy, Epco Sales, Inc., June 1987.

²¹ Personal Communication, Epco Sales, Inc., June 1987.

Table 4

Satisfactory Materials for
Electrically Isolating Gaskets^a

<u>Gasket Composition</u>	<u>Max. Service Temp., °F</u>	<u>Max. Service Pressure, psi</u>	<u>Pressure X Temperature Limitation, °F-psi¹</u>
Synthetic Fiber, NBR Binder ^b	700	1000	350,000
Synthetic Fiber, SBR Binder ^c	600	900	350,000
Synthetic Fiber, CR Binder ^d	700	1200	350,000
White Asbestos, SBR Binder ^e	650	1500	350,000
White Asbestos, CR Binder ^f	750	1200	350,000
White Asbestos, NBR Binder ^g	750	1500	350,000
EPDM ^h	300	150	20,000

^a Source: *Engineered Gasketing Products*, Technical Brochure GSX3:1AA (Garlock Mechanical Packing Division, Colt Industries, Inc., July 1986). Used by permission.

^b Compressed nonasbestos product, nitrile butadiene (Buna-N) rubber (NBR) binder and aramid-group synthetic fibers (e.g., Nomex and Kevlar).

^c Compressed nonasbestos product, styrene butadiene rubber (SBR) binder, and aramid-group synthetic fibers (e.g., Nomex and Kevlar).

^d Compressed nonasbestos product, neoprene (CR) binder, and aramid-group synthetic fibers.

^e Compressed asbestos product with SBR binder.

^f Compressed asbestos product with CR binder.

^g Compressed asbestos with NBR binder.

^h Ethylene propylene diene monomer (EPDM) homogeneous rubber product.

¹ Based on gasket thicknesses of 0.0625 in.; values increase marginally with thinner gaskets and decrease substantially with thicker gaskets.

Table 5

Typical Physical Properties
for Nonasbestos Materials

ASTM Test Method	Physical Properties
F37	Sealability Milliliters/Hour Leakage, ASTM Fuel A (isooctane): Gasket load, 500 psi Internal pressure, 9.8 psi Nitrogen: Gasket load, 3000 psi Internal pressure, 30 psi
F36	Recovery Minimum Percent:
F36	Compressibility Percent Range:
F38	Creep Relaxation Percent Relaxation:
F146	Fluid Resistance After Five Hour Immersions ASTM #1 Oil @ +300 °F, Thickness Increase Range: Weight Increase, Maximum: ASTM #3 Oil @ +300 °F, Thickness Increase Range: Tensile Loss, Maximum: ASTM Fuel A @ 70-85 °F, Thickness Increase Range: Weight Increase, Maximum: ASTM Fuel B @ 70-85 °F, Thickness Increase Range: Weight Increase, Maximum:
F152	Tensile Strength Across Grain psi: Density lb/cu ft: (grams/cm ³):

4 COATINGS FOR SOIL-SIDE CORROSION MITIGATION

Because of shorts created at isolating flanges, building foundations/walls, and other locations, a cathodic protection system cannot inhibit corrosion. Also, if the coating efficiency is less than that designed or the coating is one that deteriorates prematurely, a cathodic protection system cannot inhibit corrosion. Equally important, significant coating damage can occur during storage and installation of the conduits (Figure 13).

The basic purpose of any coating applied to the soil-side surfaces of heat distribution system casings should be to isolate the metal from the environment. A properly selected and applied coating should provide approximately 98 to 99 percent of the protection for those surfaces. Coatings do not have a coating efficiency of 100 percent because holidays always exist or can be expected to develop. It is recommended that the manufacturer supply holiday test results to verify coating efficiency. Regardless of the coating efficiency, coatings significantly reduce the current required for cathodic protection and facilitate distribution of the protective currents.

Desirable characteristics for coatings may also be applied to the soil-side surfaces of heat distribution system conduits. Basically, the coating must:

- effectively isolate the casing electrically from the soil,
- exhibit the desired ease of application such that it can be applied without creating an excessive number of holidays,
- exhibit the desired adhesion with respect to the substrate,
- resist the development of inservice holidays,
- exhibit sufficient impact, abrasion, and ductility characteristics that the coated conduits can be handled, stored, and installed using recommended procedures without excessive concern for coating damage,
- maintain its high dielectric strength for extended periods underground,
- resist disbonding related to cathodic protection, and
- exhibit characteristics that allow it to be readily repaired in the field or bonded to at welded connections/joints²²

Note that for deep burial applications, the outer casing temperatures can approach that of the internal temperature of the carrier pipe.

A wide variety of protective coatings have been applied to soil-side surfaces of conduits for underground heat distribution systems. Cut-back asphalts, low melt-point asphalt enamels, and general roofing type asphalt matrices are not recommended for this application. This is also true of cut-back coal

²² R.N. Sloan, "Protective Coatings for Underground Steel Structures," *Cathodic Protection Design Course Notebook* (USACERL, March 1987).

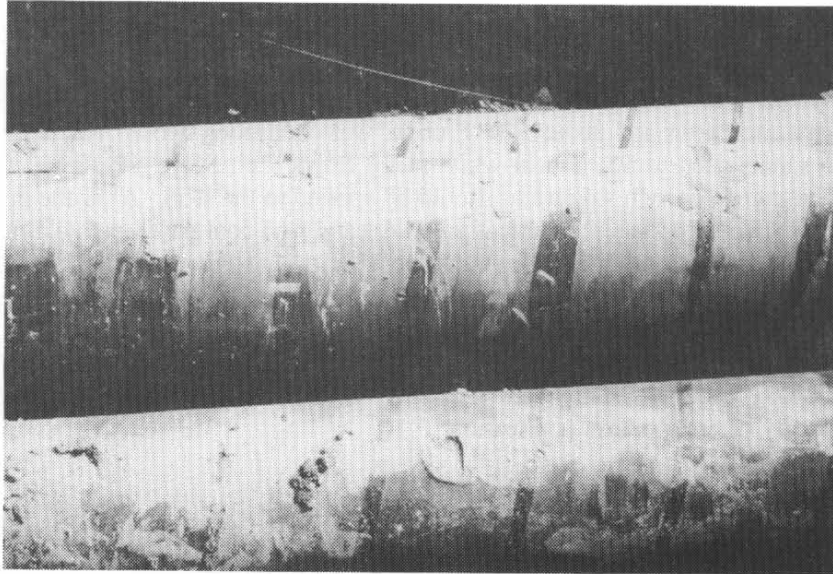

Figure 13. Damage to the bitumen coating was present before installation.

tar matrices. Asphalt based coatings in general can be expected to absorb unacceptable amounts of moisture when exposed to continuously wet environments (Figure 14) and lose a significant amount of their dielectric strength (Figure 15).²³

Coating systems that should be considered for this application include: (1) coal tar enamels, (2) coal tar epoxies, and (3) fusion bonded epoxies. Other coatings that may be applicable include high melting point (>250 °F softening point) coating systems with various mesh arrangements. These systems were not specifically addressed as a part of this investigation.

Coal Tar Enamels

Typically a coal tar enamel system, which has an upper temperature limitation of about 160 °F, would be applied to steel conduits that have been sand/grit blasted to a Steel Structures Painting Council (SSPC) commercial blast finish (i.e., SSPC-SP-6-63).²⁴ Immediately, 1 mil (0.001 in.; dry film thickness) of synthetic primer (e.g., Reilly Tar and Chemical Corporation No. 122) should be applied to the steel. Once the primer has dried, 60 mil of American Water Works Association (AWWA) Specification AWWA-

²³ K. Tator, "Maintenance Paints," *Technology of Paints, Varnishes, and Lacquers*, C.R. Martens, ed. (Reinhold Book Corporation, 1968), p 580.

²⁴ Personal Communication, B.L. Sharp, Reilly Tar and Chemical Corporation, 24 July 1987.

C-203, Type 1, coal tar enamel should be applied. While the enamel is still wet, the exterior surfaces should be wrapped with 20-mesh glass fabric. Subsequently, a second coat (30 mil) of AWWA-C-203, Type 1, coal tar enamel should be applied. The exterior surfaces of the conduits should then be wrapped with reinforced, 15-lb felt saturated with coal tar. If the conduits are to be exposed to sunlight for an extended time, whitewash should be applied over the felt.

Coal Tar Epoxies

A representative coal tar epoxy coating system, which has an upper temperature limitation of about 250 °F under dry conditions and about 120 °F under wet conditions, would be applied to steel conduits that have been sandblasted to SSPC near-white metal finish (i.e., SSPC-SP-10-63).²⁵ Immediately, 1.5 mil of polyamide-cured epoxy resin primer should be applied to the steel. After the primer has dried, two or more coats of a two-component, chemically-cured, catalyzed coal tar epoxy coating should be applied at 8 to 10 mil per coat, with the manufacturer's specified drying time being allowed between each coat. The coating system should be allowed to cure at least 5 days at 70 to 100 °F before it is exposed to the soil.

Coal tar epoxy coating systems can be applied in the field (e.g., at field-welded joints) providing the steel is properly cleaned before application.

Fusion-Bonded Epoxies

Typical fusion-bonded epoxy (FBE) coating systems are factory applied. They can be used at temperatures up to about 250 °F. Their application requires near-white (i.e., SSPC-SP-10-63) to white metal (i.e., SSPC-SP-5-63) grit-blast cleaning of the steel conduits with a resultant, nominal, 0.002-in. anchor pattern.²⁶ The steel conduits are then uniformly heated to a temperature between 450 and 475 °F using a noncontaminating heat source (e.g., electrical induction heating). With the conduits suitably heated, they pass through powder coating machines where the fusion-bonded epoxy coating product is uniformly applied to a thickness of about 16 mil using electrostatic deposition on the exterior surfaces and, if desired, air spray on the interior surfaces. After application, the coating is allowed to cure using the residual heat in the conduits. Any holidays detected in the coatings are readily repaired using "hot melt patch sticks" or two-component epoxy resins that cure at ambient temperatures.

Cutbacks (for field welding) can be coated in the field by blast cleaning the exterior surfaces of the steel to a white to near-white finish, induction heating the cleaned metal, and spraying on one application of the powder. Alternatively, the bare metal at welds can be suitably protected using heat-shrink sleeves.

²⁵ *Bitumastic No. 300-M, Koppers 654 Epoxy Primer*, Technical Data Sheets (Koppers Company, Inc., 1986/1987).

²⁶ Personal Communication, T.Fauntieroy, Pipeline and Construction Specialty Markets, 3M, 3 July 1987.

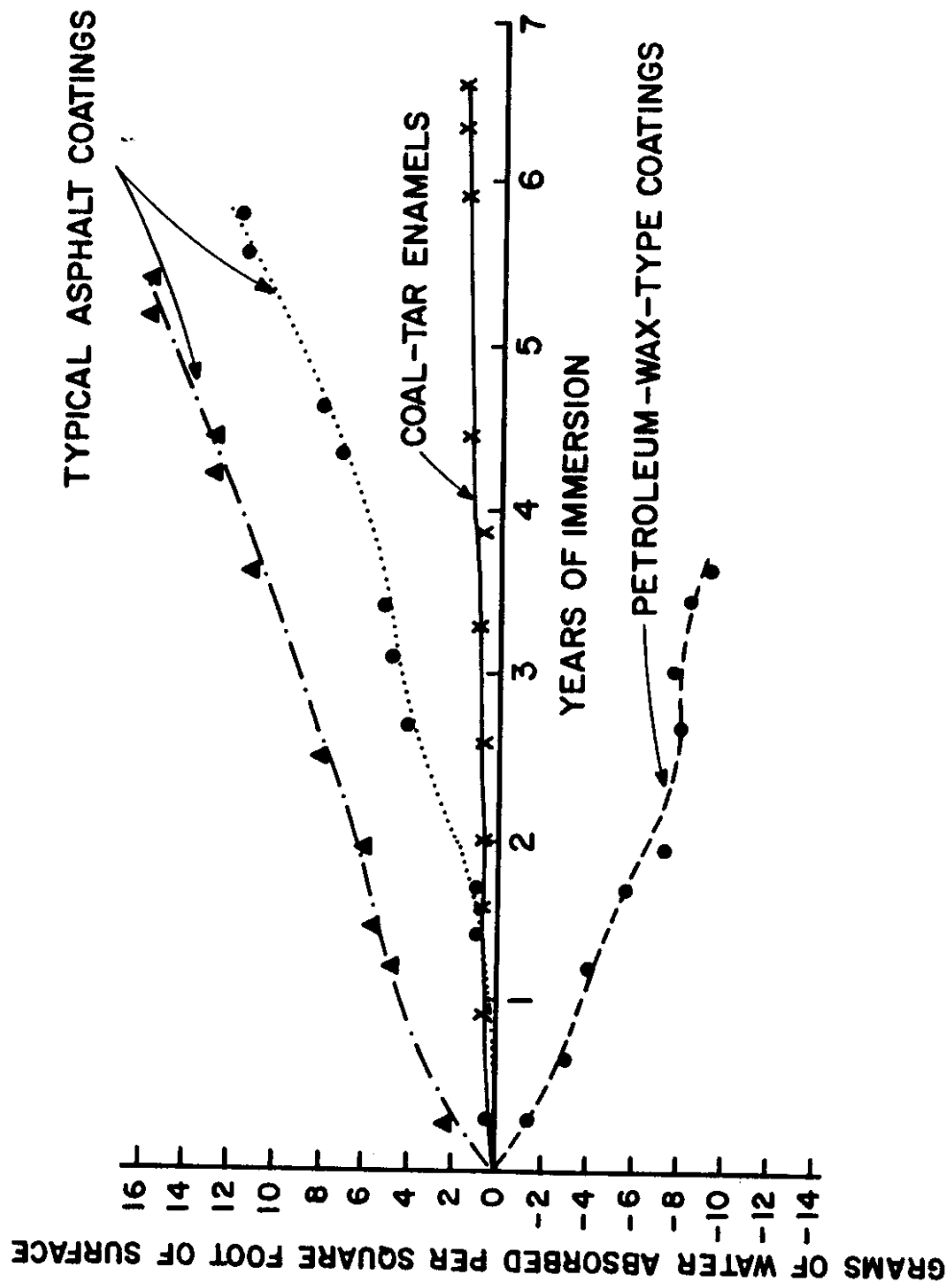

Figure 14. Effect of immersion time on the amount of water absorbed by selected coatings for steel in underground environments.

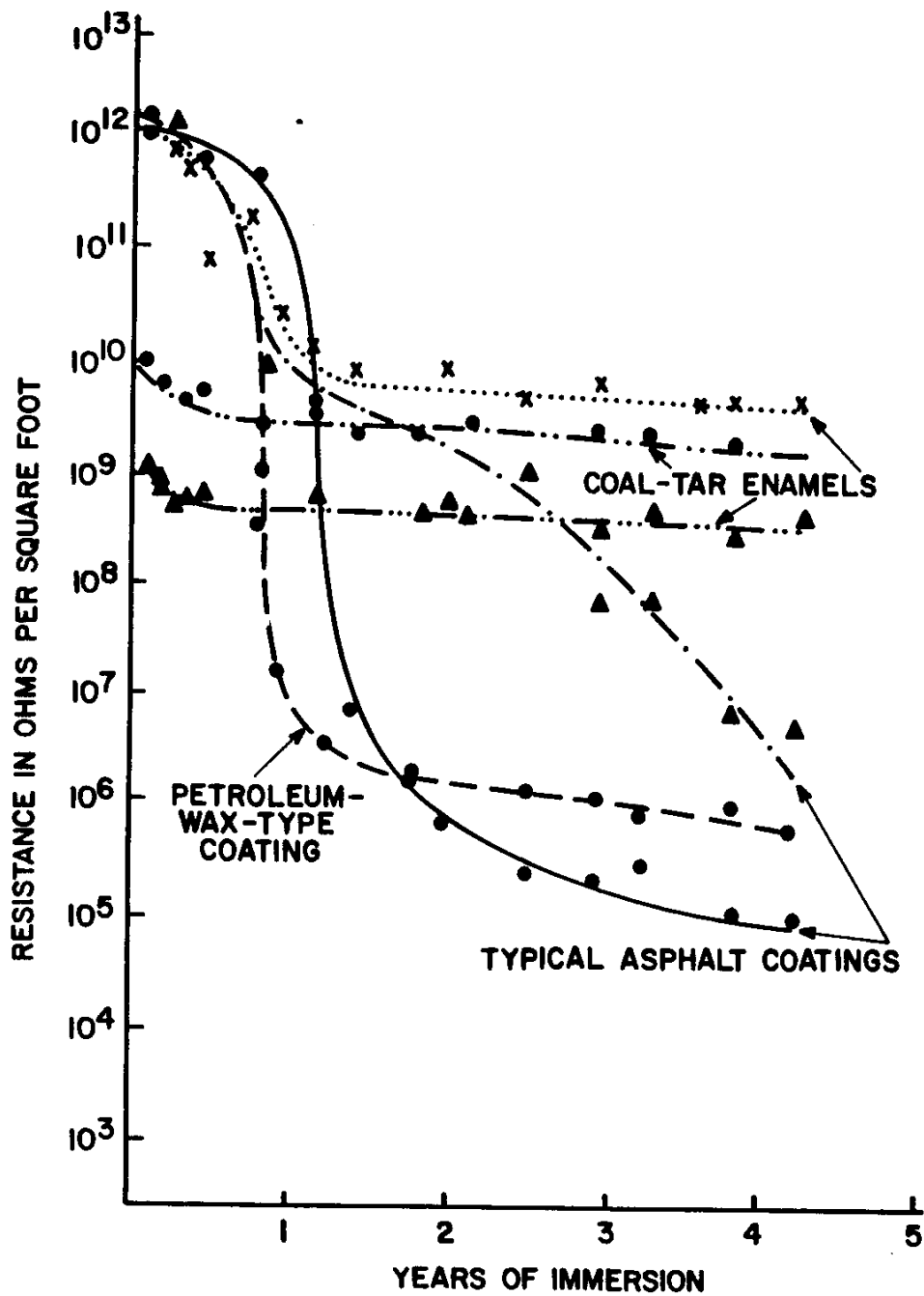

Figure 15. Effect of immersion time on the electrical resistance of selected coatings for steel in underground environments.

5 CONCLUSIONS AND RECOMMENDATIONS

Conclusions

Corrosion in buried-conduit heat distribution systems caused by the products being conveyed can be mitigated by reducing the amounts of dissolved carbon dioxide and oxygen in the products. Corrosion related to moisture in the insulation between the carrier pipe and the conduit can be mitigated by inspecting and maintaining the insulation, ensuring that the system is properly designed and installed, and by developing specifications that limit the amounts of leachable aggressive species (e.g., chlorides and sulfates) in insulation. Corrosion of the conduits caused by aggressive soils can be mitigated by the use of sacrificial anodes (cathodic protection) and surface coatings.

Effective cathodic protection for heat distribution systems can be achieved by installing isolating gaskets, washers, and bolt sleeves to help mitigate corrosion current. Thermal, chemical, and strength properties of gasket materials and the operating characteristics of the heat distribution system must be evaluated before selecting the isolating material.

A properly selected and applied coating provides approximately 98 to 99 percent of the protection needed for the soil-sided surfaces of conduits. In addition to isolating the conduit from the soil, a coating should be easily applied and repaired in the field, and should adhere completely (not develop holidays or debond). A coating should also resist abrasion and damage during handling and maintain its dielectric strength for extended periods underground.

Recommendations

To reduce the frequency of premature corrosion-induced failures in buried-conduit heat distribution systems, the following steps should be taken:

1. Design cathodic protection systems according to criteria specified in Technical Manual (TM) 5-811-7, *Electrical Design Cathodic Protection*,
2. Carefully select and apply coating systems,
3. Select and install appropriate electrical isolation flanges,
4. Inspect the project through all phases of installation, and
5. Develop an enforceable means of correcting installation deficiencies identified by site inspectors.

Metric Conversion Table

1 in.	=	25.4 mm
1 mil	=	0.0254 mm
1 ft	=	0.305 m
1 psi	=	6.89 kPa
1 lb	=	0.453 kg
1 sq ft	=	0.093 m ²
°C	=	0.55(°F-32)

REFERENCES

- American Water Works Association (AWWA) C203-86, Type 1, Coal-tar protective coatings and linings for steel water pipe lines-enamel and tape-hot applied.
- Air Force Manual (AFM) 88-9, *Corrosion Control*, Chapter 4 (Headquarters, U.S. Air Force, Washington, D.C., 1 August 1964).
- Atkinson, T.R., "Corrosion and Protection of Buried Pipelines: Preparation for Cathodic Protection," *Bulletin of the Institute of Corrosion Technology*, No. 47 (October 1974), pp 1-10.
- Bitumastic No. 300-M, Koppers 654 Epoxy Primer*, Technical Data Sheets (Koppers Company, Inc., 1986/1987).
- Blake, R.T., *Water Treatment for HVAC and Potable Water Systems* (McGraw-Hill, 1980), pp 146-149.
- Collins, L.F., "Corrosion of Steam Condensate Lines," *Corrosion Handbook*, H.H. Uhlig, ed. (John Wiley and Sons, Inc., 1948), pp 538-545.
- Corps of Engineers Guide Specification (CEGS)-15705, *Underground Heat Distribution System and Condensate Return System* (Prefabricated or Pre-Engineered Types). New number is (CEGS) 02695 (U.S. Army Corps of Engineers [USACE] Marvh 1989).
- Corps of Engineers Guide Specification (CEGS)-15709, *Heat Distribution Systems Outside of Buildings: (Concrete Shallow Trench Systems)*, Notice #5, April 1987, AWWA-C-203, Type 1.
- Delahunt, J.F., "Corrosion Control Under Thermal Insulation and Fire Proofing," *Bulletin of the Institution of Corrosion Sciences and Technology*, Vol 20, No. 2 (May 1982), pp 2-7.
- Engineered Gasketing Products*, Technical Brochure GSX3: 1AA (Garlock Mechanical Packing Division, Colt Industries, Inc., July 1986).
- Ewing, S.P., *Soil Corrosion and Pipe Line Protections* (American Gas Association, 1938).
- Fitzgerald, J.H., "Corrosion Control for Buried Piping," *Heating/Piping/Air Conditioning*, Vol 46, No. 3 (March 1974).
- Lazar, P. III, "Factors Affecting Corrosion of Carbon Steel Under Thermal Insulation," *Corrosion of Metals Under Thermal Insulation*, W.I. Pollock and J.M. Barnhart, eds. (American Society for Testing and Materials [ASTM], 1985), pp 11-26.

- Macguire, J.J., "After Boiler Corrosion," *Industrial and Engineering Chemistry*, Vol 46, No. 5 (May 1954), pp 994-997.
- Masse, R.B., "Steam Condensate Corrosion," *Materials Protection*, Vol 5, No. 7 (July 1966), pp 37-39.
- Mattsson, E. "Focus on Copper in Modern Corrosion Research," *Materials Performance*, Vol 26, No. 4 (April 1987), pp 9-16.
- Myers, J.R., "Corrosion of Steel, Steam-Condensate Return Lines by the Products Conveyed," prepared for U.S. Army Construction Engineering Research Laboratory (USACERL) under Purchase Order No. DACA88-86-M-1058, 22 August 1986.
- Myers, J.R., and M. A. Aimone, *Corrosion Control for Underground Steel Pipe-lines: A Treatise on Cathodic Protection* (JRM Associates, 1976).
- Nicholson, J.D., "Application of Thermal Insulation to Stainless Steel Surfaces," *Bulletin of the Institution of Corrosion Science and Technology*, Vol 19, No. 5 (October 1981), pp 2-5.
- Obrecht, M.F., and J.R. Myers, "Potable Water Systems in Buildings: Deposit and Corrosion Problems," *Heating/Piping/Air Conditioning*, Vol 45, No. 5 (May 1973), pp 77-83.
- Perma-Pipe Underground Conduit System for U.S. Military Construction* (Midwesco Enterprises, Inc., September 15, 1964), p 19.
- Romanoff, M., "Results of National Bureau of Standards Corrosion Investigations in Disturbed and Undisturbed Soils," *Proceedings of the Fourteenth Annual Application Underground Corrosion Short Course* (Gulf Publishing Company, 1969), pp 433-456.
- Segan, E.G., and C-P. Chen, *Investigation of Tri-Service Heat Distribution Systems*, Technical Report M-347/ADA145181 (USACERL, June 1984).
- Segan, E.G., E.W. Blackmon, and C. Marsh, *The Effects of Minor Constituents in Calcium Silicate Insulation on the Corrosion of Underground Heat Distribution Systems*, Technical Report M-346/ADA143378 (USACERL, June 1984).
- Senatoroff, N.K., "Experiences of the Southern Counties Gas Company of California," *Journal of the American Water Works Association*, Vol 43 (1951) pp 1017-1020.
- Sloan, R.N., "Protective Coatings for Underground Steel Structures," *Cathodic Protection Design Course Notebook* (USACERL, March 1987).
- SSPC-SP-6-89, "Surface Preparation Specification Commercial Blast Cleaning," 4 pp.
- SSPC-SP-10-89, "Surface Preparation Specification Near-White Blast Cleaning," 4 pp.
- SSPC-SP-5-89, "Surface Preparation Specification White Metal Blast Cleaning," 4 pp.
- Submittal Brochure for Tri-Service Specifications: Class A Underground Heat Distribution Systems* (Durant Insulated Pipe Company, May 29, 1967), p 25.

Tator, K. "Maintenance Paints," *Technology of Paints, Varnishes, and Lacquers*, C.R. Martens, ed. (Reinhold Book Corporation, 1968), p 580.

Technical Manual (TM) 5-811-7, *Electrical Design Cathodic Protection* (Headquarters, Department of the Army, 22 April 1985).

USACERL DISTRIBUTION

Chief of Engineers
ATTN: CEHEC-IM-LH (2)
ATTN: CEHEC-IM-LP (2)
ATTN: CERD-L
ATTN: CECC-P
ATTN: CECW
ATTN: CECW-O
ATTN: CECW-P
ATTN: CECW-RR
ATTN: CEMP
ATTN: CEMP-C
ATTN: CEMP-E
ATTN: CERD
ATTN: CERD-C
ATTN: CERD-M
ATTN: CERM
ATTN: DAEN-ZCZ
ATTN: DAEN-ZCJ
ATTN: DAEN-ZCM
ATTN: DAEN-ZCE

CEHSC
ATTN: CEHSC-ZC 22060
ATTN: CEHSC-F 22060
ATTN: CEHSC-TT-F 22060
ATTN: DET III 79906

US Army Engineer Districts
ATTN: Library (41)

US Army Engr Divisions
ATTN: Library (14)

US Army Europe
ODCS/Engineer 09403
ATTN: ABAEN-FE
ATTN: ABAEN-ODCS
V Corps
ATTN: DEH (11)
VII Corps
ATTN: DEH (16)
21st Support Command
ATTN: DEH (12)
USA Berlin
ATTN: DEH (9)
Allied Command Europe (ACE)
ATTN: ACSGEB 09011
ATTN: SHIB/Engineer 09055
USASSETAF
ATTN: AESE-EN-D 09019
ATTN: ACSEN 09168
ATTN: AESE-VE 09168

8th USA, Korea
ATTN: DEH (19)

ROK/US Combined Forces Command 96301
ATTN: EUSA-HHC-CFC/Engr

Pt. Leonard Wood, MO 65473
ATTN: Canadian Liaison Officer
ATTN: German Liaison Staff
ATTN: British Liaison Officer (2)
ATTN: French Liaison Officer

USA Japan (USARJ)
ATTN: DEH-Okinawa 96331
ATTN: DCSEN 96343
ATTN: HONSHU 96343

Area Engineer, AEDC-Area Office
Arnold Air Force Station, TN 37389

416th Engineer Command 60623
ATTN: Facilities Engineer

US Military Academy 10996
ATTN: Facilities Engineer
ATTN: Dept of Geography &
Environmental Engr
ATTN: MAEN-A

AMC - Dir., Inst., & Svcs.
ATTN: DEH (23)

DLA ATTN: DLA-WI 22304

DNA ATTN: NADS 20305

FORSKOM (28)
FORSKOM Engr, ATTN: Spt Det. 15071
ATTN: Facilities Engineer

HSC
Walter Reed AMC 20307
ATTN: Facilities Engineer
Pt. Sam Houston AMC 78234
ATTN: HSLO-F
Fitzsimons AMC 80045
ATTN: HSHG-DEH

INSCOM - Ch. Inst. Div.
Vint Hill Farms Station 22186
ATTN: IAV-DEH
Arlington Hall Station 22212
ATTN: Engr & Hsg Div

USA AMCCOM 61299
ATTN: Library
ATTN: AMSMC-RI

Military Dist of Washington
ATTN: DEH
Fort Lesley J. McNair 20319
Fort Myer 22211
Cameron Station (3) 22314

Military Traffic Mgmt Command
Bayonne 07002
Falls Church 20315
Sunny Point MOT 28461
Oakland Army Base 94626

NARADCOM, ATTN: DRDNA-F 01760

TARCOM, Fac. Div. 48090

TRADOC (19)
HQ, TRADOC, ATTN: ATEN-DEH 23651
ATTN: DEH

TSARCOM, ATTN: STSAS-F 63120

USAIS
Fort Ritchie 21719
Fort Huachuca 85613
ATTN: Facilities Engineer (3)

WESTCOM
Fort Shafter 96858
ATTN: DEH
ATTN: APEN-A

SHAPE 09055
ATTN: Survivability Sect. CCB-OPS
ATTN: Infrastructure Branch, LANDA

HQ USEUCOM 09128
ATTN: ECJ 4/7-LOE

Fort Belvoir, VA
ATTN: Australian Liaison Officer 22060
ATTN: Water Resource Center 22060
ATTN: Engr Studies Center 22060
ATTN: Engr Topographic Lab 22060
ATTN: ATZA-TE-SW 22060
ATTN: CBCC-R 22060

CECRL, ATTN: Library 03755

CEWES, ATTN: Library 39180

HQ, XVIII Airborne Corps and
Pt. Bragg 28307
ATTN: AFZA-DEH-EE

Chamute AFB, IL 61868
3345 CES/DE, Stop 27

AMMRC 02172
ATTN: DRXMR-AF
ATTN: DRXMR-WE

Norton AFB, CA 92409
ATTN: AFRCE-MX/DE

Tyndall AFB, FL 32403
AFESC/Engineering & Service Lab

NAVFAC
ATTN: Division Offices (11)
ATTN: Facilities Engr Cmd (9)
ATTN: Naval Public Works Center (9)
ATTN: Naval Civil Engr Lab 93043 (3)
ATTN: Naval Constr Battalion Ctr 93043

Engineering Societies Library
New York, NY 10017

National Guard Bureau 20310
Installation Division

US Government Printing Office 20401
Receiving/Depository Section (2)

US Army Env. Hygiene Agency
ATTN: HSHB-ME 21010

American Public Works Association 60637

Nat'l Institute of Standards & Tech 20899

Defense Technical Info. Center 22304
ATTN: DTIC-PAB (2)

324
03/91

Metallurgy Team Distribution

Chief of Engineers
ATTN: CEMP-ZA
ATTN: CEMP-ZM (2)

US Army Engineer District
ATTN: Chief, Engr Div
Baltimore 21203
Charleston 29402
Vicksburg 39180
Louisville 40201
Omaha 68102
Little Rock 72203
San Francisco 94105
Walla Walla 99362
Philadelphia 19106
ATTN: Chief, NAPEN-D
Norfolk 23510
ATTN: Chief, NAOEN-D
Wilmington 28402
ATTN: Chief, SAWEN-D
Savannah 31402
ATTN: Chief, SASAS-L
Jacksonville 32232
ATTN: Constr Div
Mobile 36628
ATTN: Chief, SAMEN-C
ATTN: Chief, SAMEN-D
Memphis 38103
ATTN: Chief, LMMED-DM
St. Paul 55101
ATTN: Chief, ED-D
New Orleans 70160
ATTN: Chief, LMNED-DG
Sacramento 95814
ATTN: SPKED-D
Portland 97208
ATTN: Chief, EN-DB-SA
Seattle 98124
ATTN: Chief, NPSCO
Alaska 99506
ATTN: Chief, NAPEN-G-M

US Army Engineer Division
Ohio River 45201
Pacific Ocean 96858
North Pacific 97208
New England 02254
ATTN: Chief, NEDED-T
North Atlantic 10007
ATTN: Chief, NADEN-T
South Atlantic 30335
ATTN: Chief, SADEN-TS
Huntsville 35807
ATTN: Chief, HNDED-CS
ATTN: Chief, HNDED-SR
Southwestern 75242
ATTN: SWDED-TM

West Point, NY 10996
ATTN: Library

Fort Leavenworth, KS 66027
ATTN: ATZLCA-SA

Fort McPherson, GA 30330
ATTN: AFEN-CD

Fort Monroe, VA 23651
ATTN: ATEN-AD

Elmendorf AFB, AK 99506
ATTN: 21 CES/DEEEEC

7th US Army 09407
ATTN: AETTM-DTT-MG-EH

US Army Science & Technology 96328
Center - Far East Office

Tyndall AFB, FL 32403
AFESC/PRT

Dept of Transportation Library 20590

43
05/91