



The contents of this report are not to be used for advertising, publication, or promotional purposes. Citation of trade names does not constitute an official endorsement or approval of the use of such commercial products.

The findings of this report are not to be construed as an official Department of the Army position, unless so designated by other authorized documents.



PRINTED ON RECYCLED PAPER

USACEWES



3 5925 00305 2997

39946047

TA7  
W34m  
no. CHL-98-5  
c.3

Miscellaneous Paper CHL-98-5  
September 1998

# Wave Response of Kikiaola Harbor, Kauai, Hawaii

by Edward F. Thompson, Lihwa Lin,  
Lori L. Hadley, Jon M. Hubertz

U.S. Army Corps of Engineers  
Waterways Experiment Station  
3909 Halls Ferry Road  
Vicksburg, MS 39180-6199

Final report

Approved for public release; distribution is unlimited



**US Army Corps  
of Engineers**  
Waterways Experiment  
Station

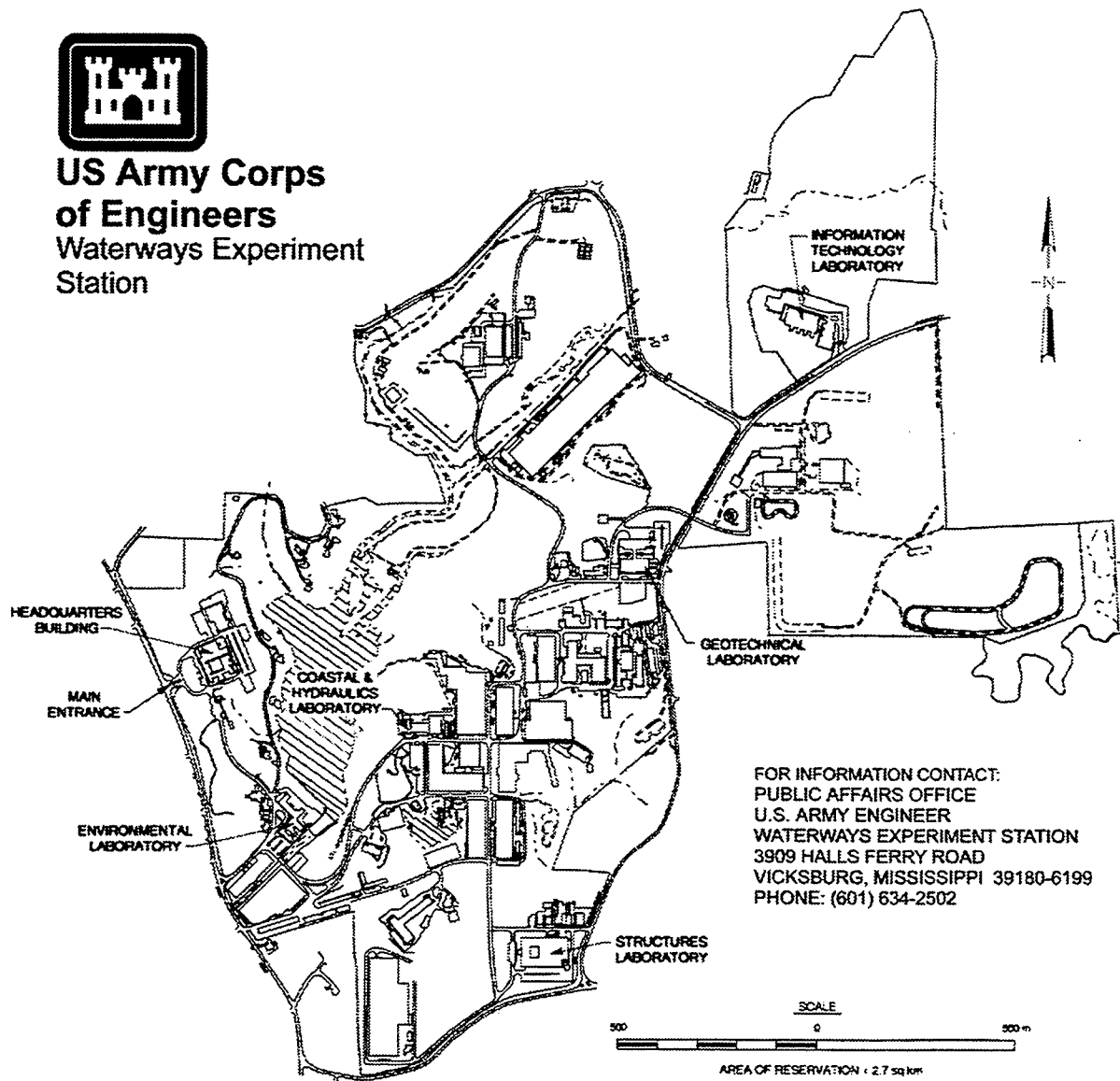

FOR INFORMATION CONTACT:  
PUBLIC AFFAIRS OFFICE  
U.S. ARMY ENGINEER  
WATERWAYS EXPERIMENT STATION  
3909 HALLS FERRY ROAD  
VICKSBURG, MISSISSIPPI 39180-6199  
PHONE: (601) 634-2502

**Waterways Experiment Station Cataloging-in-Publication Data**

Wave response of Kikiaola Harbor, Kauai, Hawaii / by Edward F. Thompson ... [et al.] ;  
prepared for U.S. Army Engineer Division, Pacific Ocean.

74 p. : ill. ; 28 cm. — (Miscellaneous paper ; CHL-98-5)

Includes bibliographic references.

1. Ocean waves — Hawaii — Kikiaola Harbor. 2. Wind waves — Hawaii — Kauai. 3. Harbors — Hydrodynamics — Mathematical models. 4. Harbors — Hawaii — Kauai. I. Thompson, Edward F. II. United States. Army. Corps of Engineers. Pacific Ocean Division. III. U.S. Army Engineer Waterways Experiment Station. IV. Coastal and Hydraulics Laboratory (U.S. Army Engineer Waterways Experiment Station) V. Series: Miscellaneous paper (U.S. Army Engineer Waterways Experiment Station) ; CHL-98-5. TA7 W34m no.CHL-98-5

# Contents

---

Preface .....	vi
Conversion Factors, Non-SI to SI (metric)	
Units of Measurements .....	vii
1—Introduction .....	1
Background .....	1
Study Approach .....	2
2—Wind Wave and Swell Climate .....	8
Sources .....	8
Deepwater Wave Climate .....	8
Wave Climate at Kikiaola Harbor .....	14
3—Numerical Model .....	16
Objectives and Approach .....	16
Model Description .....	16
Test Procedures and Calculations .....	22
4—Harbor Response to Wind Waves and Swell .....	25
Amplification Factors .....	25
Evaluation Against Operational Criteria for Wind Waves and Swell .....	28
5—Harbor Oscillations .....	31
Amplification Factors .....	31
Evaluation Against Operational Criteria for Long Waves .....	35
6—Conclusions and Recommendations .....	39
References .....	42
Appendix A: Bathymetry and Output Basin Locations .....	A1

Appendix B: Wind Wave and Swell Summaries from Numerical Model . . .	B1
Appendix C: Harbor Oscillation Summaries from Numerical Model . . . . .	C1
Appendix D: Notation . . . . .	D1

SF 298

## List of Figures

Figure 1. Kikiaola Harbor location . . . . .	2
Figure 2. Kikiaola Harbor, existing plan . . . . .	3
Figure 3. Plan 1 . . . . .	5
Figure 4. Plan 6 . . . . .	6
Figure 5. Location map for NDBC buoys and nearby WIS Level 1 Stations . .	9
Figure 6. Location map for wave climate study, WIS Level 1 grid . . . . .	10
Figure 7. Location map for wave climate study, WIS Level 2 grid . . . . .	11
Figure 8. Location map for wave climate study, WIS Level 3 grid . . . . .	12
Figure 9. Deepwater wave climate, $H_s$ . . . . .	13
Figure 10. Deepwater wave climate, $T_p$ . . . . .	13
Figure 11. Deepwater wave climate, $\theta_m$ (deg, coming from) . . . . .	13
Figure 12. Harbor entrance wave climate, $H_s$ . . . . .	14
Figure 13. Harbor entrance wave climate, $\theta_m$ (deg, coming from) . . . . .	15
Figure 14. Grid of existing harbor . . . . .	18
Figure 15. Bathymetry, existing harbor . . . . .	20
Figure 16. Possible berthing plan for Kikiaola Harbor (U.S. Army Corps of Engineers 1980) . . . . .	21
Figure 17. Wave reflection coefficient values, short waves, existing harbor . .	22
Figure 18. Incident wave directions . . . . .	23

Figure 19. Amplification factor and phase contours, 12-sec wave period, 200-deg direction . . . . .	26
Figure 20. Comparison of $(A_{amp})_{eff}$ averaged over periods of 6-20 sec . . . . .	27
Figure 21. Comparison of $H_s$ exceeded 10 percent of the time . . . . .	30
Figure 22. Harbor oscillation definitions . . . . .	31
Figure 23. Resonant long wave amplification factor contours, existing harbor .	33
Figure 24. Resonant long wave phase contours, existing harbor . . . . .	34
Figure 25. Resonant long wave amplification factor contours, Plan 6 . . . . .	36
Figure 26. Resonant long wave phase contours, Plan 6 . . . . .	37

## List of Tables

Table 1. Comparison of WIS Level 1 hindcasts and NDBC buoy data, 1989 .	10
Table 2. Summary statistics, NDBC buoys and WIS . . . . .	12
Table 3. Grid sizes . . . . .	19
Table 4. Parameter values used in HARBD . . . . .	20
Table 5. Summary of incident short wave conditions . . . . .	22
Table 6. Summary of incident long wave conditions . . . . .	24

# Preface

---

This study was authorized by the U.S. Army Engineer Division, Pacific Ocean (POD), and was conducted by personnel of the Coastal Hydrodynamics Branch (CHB), Navigation and Harbors Division (NHD), Coastal and Hydraulics Laboratory (CHL), of the U.S. Army Engineer Waterways Experiment Station (WES). The study was conducted during the period August 1996 through July 1997. Messrs. Tim Young and Lincoln Gayagas, POD, oversaw progress of the study.

Dr. Edward F. Thompson, CHB, was the WES point of contact for the study. This report was prepared by Dr. Thompson, Dr. Lihwa Lin, and Ms. Lori L. Hadley, all of CHB, and Dr. Jon M. Hubertz, formerly of CHB. Drs. Lin and Hubertz conducted the wave climate analysis portion of the study. Direct supervision was provided by Dr. Martin C. Miller, former Chief, CHB. General supervision was provided by Mr. C. E. Chatham, Chief, NHD, Mr. Charles C. Calhoun, Jr., Assistant Director, CHL, and Dr. James R. Houston, Director, CHL.

At the time of publication of this report, Dr. Robert W. Whalin was Director of WES. COL Robin R. Cababa, EN, was Commander.



## Conversion Factors, Non-SI to SI Units of Measurement

---

Non-SI units of measurement used in this report can be converted to SI units as follows:

Multiply	By	To Obtain
acres	4,046.873	square meters
degrees (angle)	0.01745329	radian
feet	0.3048	meters
knots (international)	0.5144444	meters per second
miles (US Statute)	1.6093	kilometers
nautical miles	1.852	kilometers

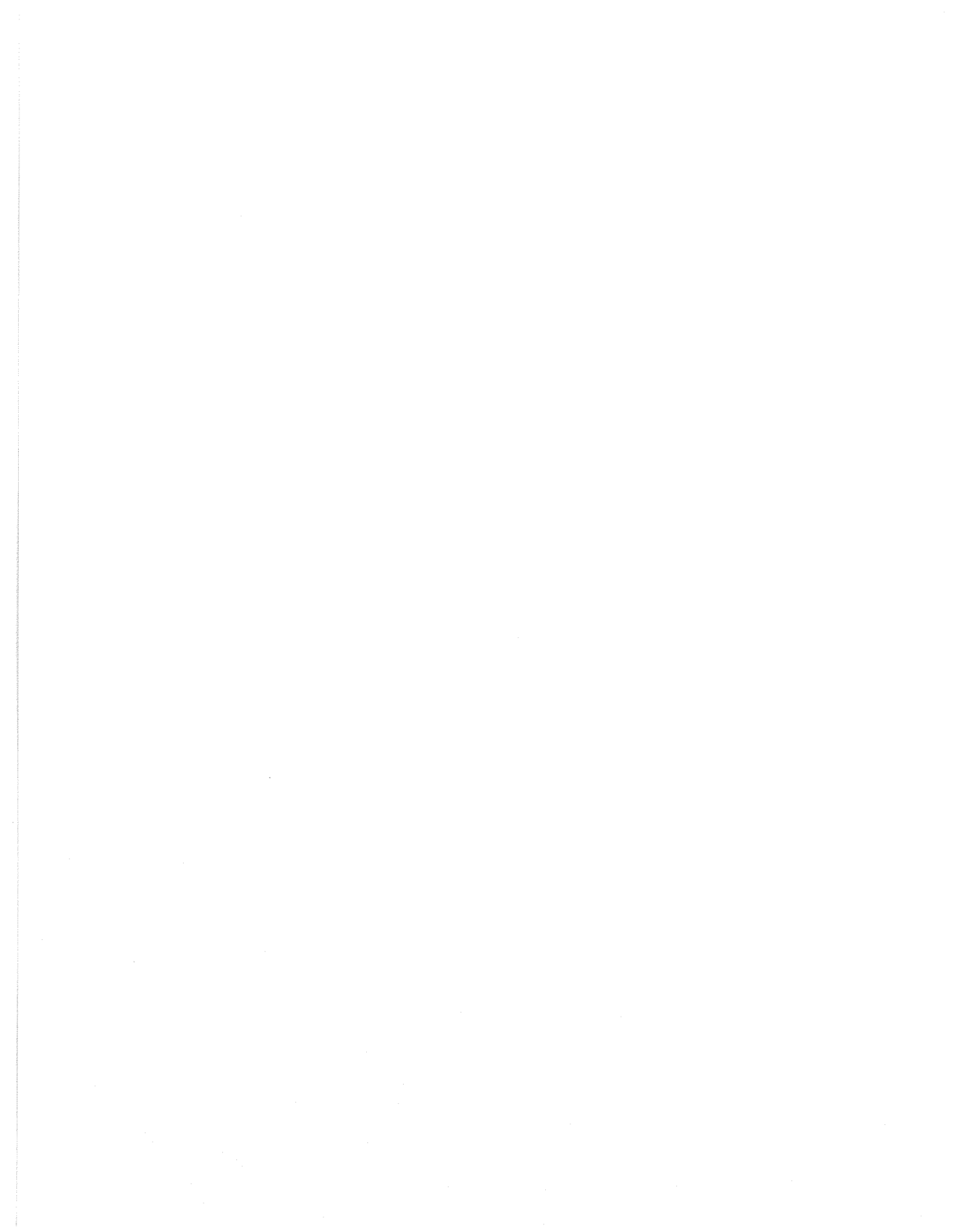

# 1 Introduction

---

## Background

Kikiaola Harbor is a small, shallow-draft harbor on the Island of Kauai. The harbor is approximately 100 miles west and a little north of Honolulu, Oahu, and is located along the western part of Kauai's south shore (Figure 1). Nearby towns of Kekaha and Waimea are 1 mile northwest and 1.5 mile east of the harbor, respectively. Lihue, the county seat and business center of Kauai, is located approximately 23 miles east of the harbor. The local shoreline is a relatively straight, low, wide beach that reaches from Oomano Point at its western extent to the Waimea River on the east, a distance of 2.7 miles.

Kikiaola Harbor was originally developed by the State of Hawaii in 1959. Inner and outer stub extensions to the east breakwater and a short inner breakwater were added in 1964 to form the present harbor (Figure 2). The additional structures were needed to reduce surge within the harbor. A wharf and boat ramp are located along the north boundary of the harbor, east of the inner breakwater.

Prevailing northeast tradewinds result in a strong predominance of winds from northeast, east, and southeast at Kikiaola Harbor. Typical wind speeds are 10 to 20 mph. Winter storms can generate strong winds from the south. The harbor is exposed to waves approaching from a sector between  $N 82^{\circ} W$  and  $S 46^{\circ} E$  (Figure 1), though the small island of Niihau creates some sheltering in the western part of this sector. Southern swell, generated by storms in the southern Pacific and Indian Oceans, is a significant part of the wave climate. Also, waves generated by storms in the North Pacific can wrap around the western side of Kauai and affect Kikiaola Harbor. Hurricanes can attack the harbor. This source of waves is important for structure design but is sufficiently rare that it does not impact the operational concerns of the present study.

Use of the existing harbor is limited by two primary factors. First, the harbor is quite shallow. Sediment movement along the local coast, predominantly from east to west, has resulted in shoaling of the entrance and inner harbor. Second, the existing entrance experiences breaking wave conditions which are hazardous to navigation. These two factors are interrelated. Breaking waves are more likely in the existing, shoaled entrance than they would be in a deeper, maintained entrance channel.

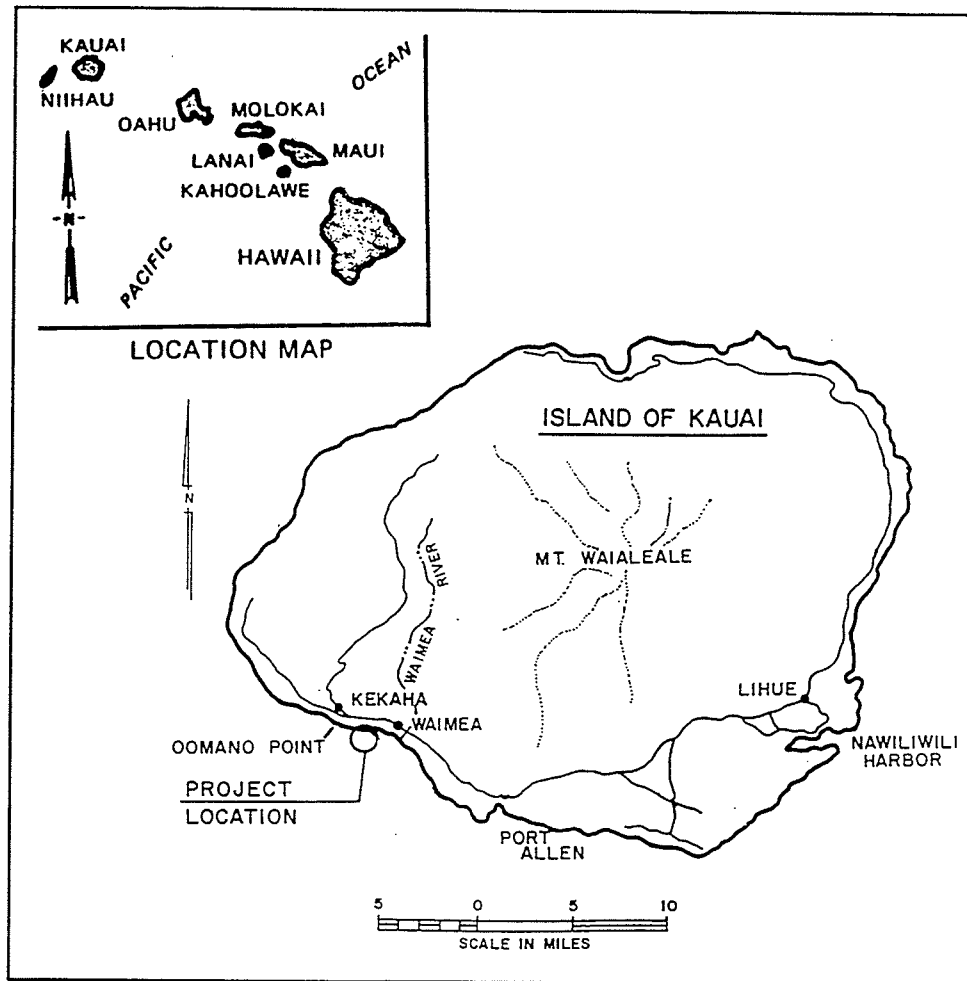

Figure 1. Kikiaola Harbor location

The U.S. Army Engineer Division, Pacific Ocean, developed several plans for improving operational conditions in Kikiaola Harbor (U.S. Army Engineer Division, Pacific Ocean 1980). The present study focuses on evaluating wave conditions in the most promising plans to help insure that operational objectives are met.

## Study Approach

The study described in this report was performed by the U.S. Army Engineer Waterways Experiment Station (WES), Coastal and Hydraulics Laboratory (CHL). The approach consisted of the following components:

- a. Develop wave climate information at the harbor site.
- b. Use a numerical model to investigate existing and alternative harbor modification plans.

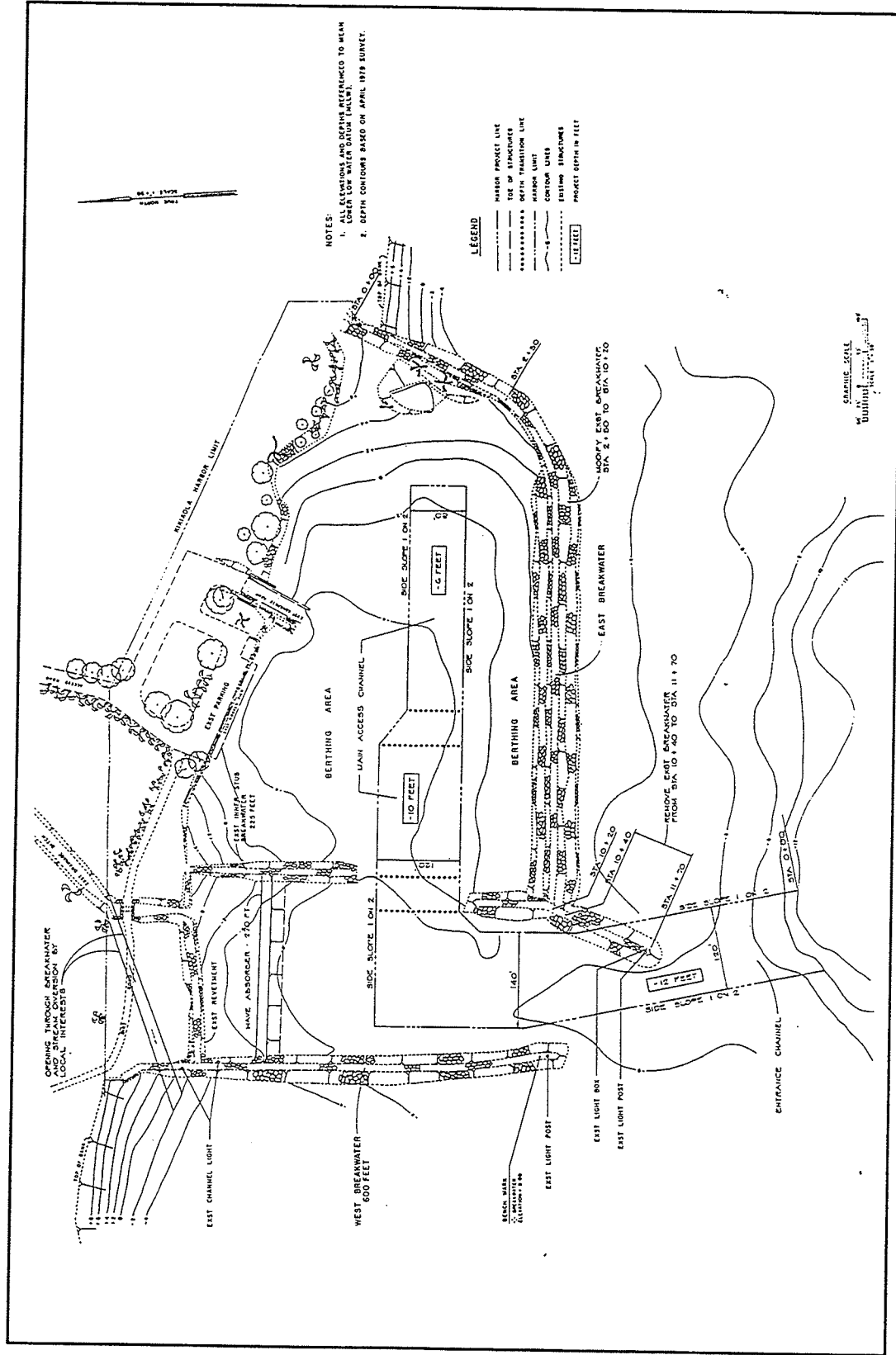

Figure 2. Kikiaola Harbor, existing plan

Wind wave and swell climate was investigated primarily with numerical hindcast information covering a period of one year. Ideally, a longer time period would be used to establish wave climate, but only one year was available from a comprehensive re-hindcast of the Pacific Ocean within the time frame of this study. Even one year of information can be expected to give reasonable representation of the lower 99 percent of wave conditions, which cover the main concerns in this study (Thompson and Harris 1972). Buoy measurements from several locations were used to help validate the hindcasts. Hindcast wave information was used as a boundary condition for nested finer grids which allowed sheltering of the islands of Kauai and Niihau to be modeled. Deepwater waves offshore of Kikiaola Harbor were transformed by a simple method to a depth of 4 m for use as an incident condition in the harbor wave model. The wave climate study is presented in Chapter 2.

A numerical wave model was set up to cover the harbor and an area outside the harbor extending about 300 yd seaward of the entrance. Two proposed harbor plans and the existing harbor were studied. Both plans include modification of the east and west breakwaters, dredging of an entrance channel to a depth of 12 ft below MLLW, and dredging of an inner access channel to a depth of 8 ft MLLW. Special features of each plan are:

*a. Plan 1 (Figure 3).* Remove outer stub of east breakwater; remove and reconstruct inner stub of east breakwater a small distance further east; raise crest elevation of exposed portions of east breakwater by 3-4 ft and flatten seaward slope to 1:2; widen outer 220 ft of west breakwater; dredge 725-ft long entrance channel with width varying from 105 to 205 ft and maneuvering area to facilitate a 90 deg turn into access channel; dredge 320-ft long access channel varying in width from 70 to 105 ft.

*b. Plan 6 (Figure 4).* Remove outer and inner stubs of east breakwater; raise crest elevation of exposed portions of east breakwater by 3-4 ft and flatten seaward slope to 1:2; extend east breakwater further west to a distance of 100 ft past the existing west breakwater location; shorten west breakwater to allow space for access channel; dredge entrance and access channels comparable to those in Plan 1.

The numerical model used for the studies, HARBD, is the standard USAEWES tool for numerical harbor wave investigations. The model includes the following assumptions:

- a.* No wave transmission through the breakwaters.
- b.* No wave overtopping of structures.
- c.* Structure crest elevations above the water surface cannot be tested or optimized.
- d.* Currents in the channel can not be evaluated.

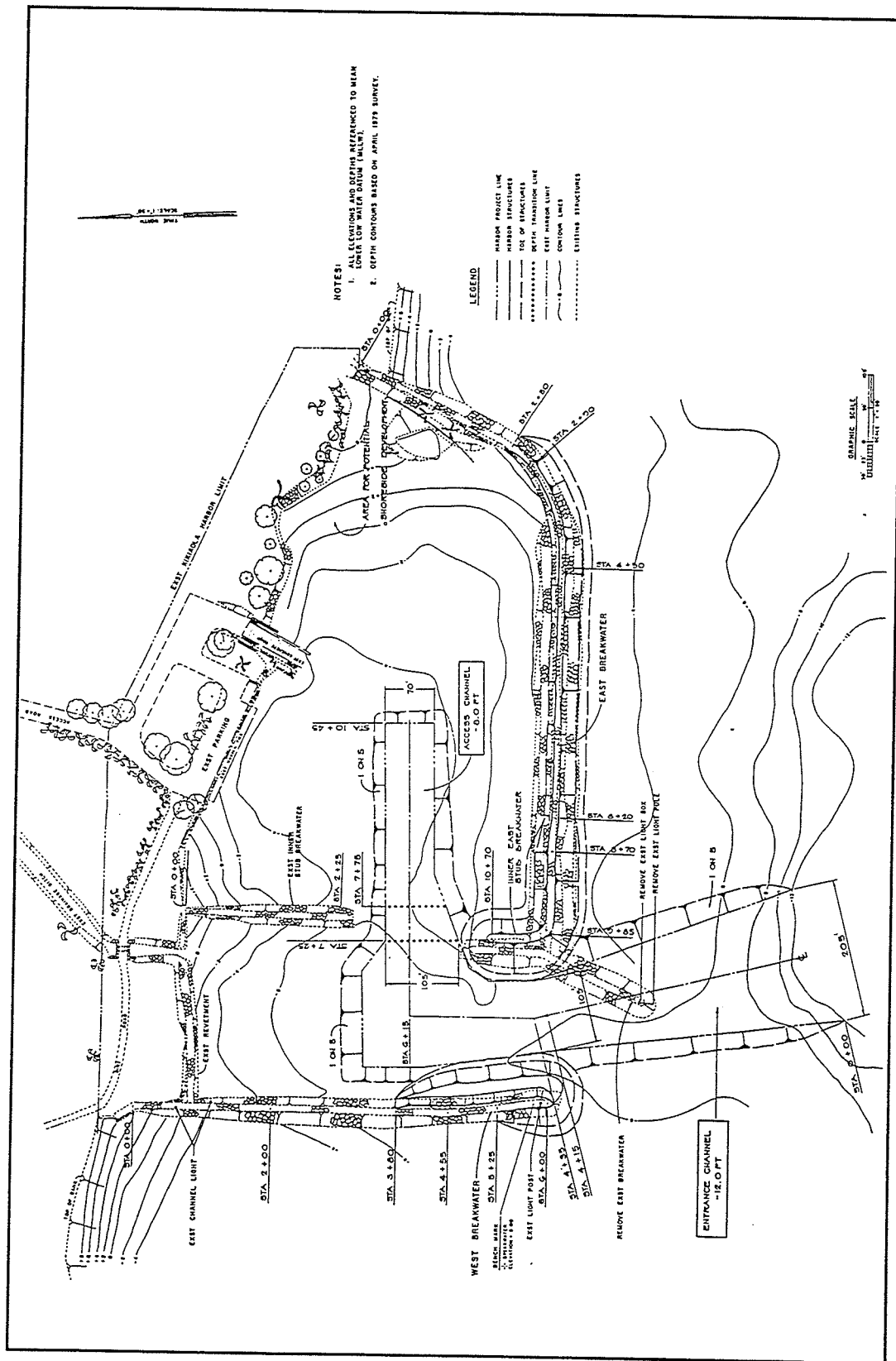

Figure 3. Plan 1

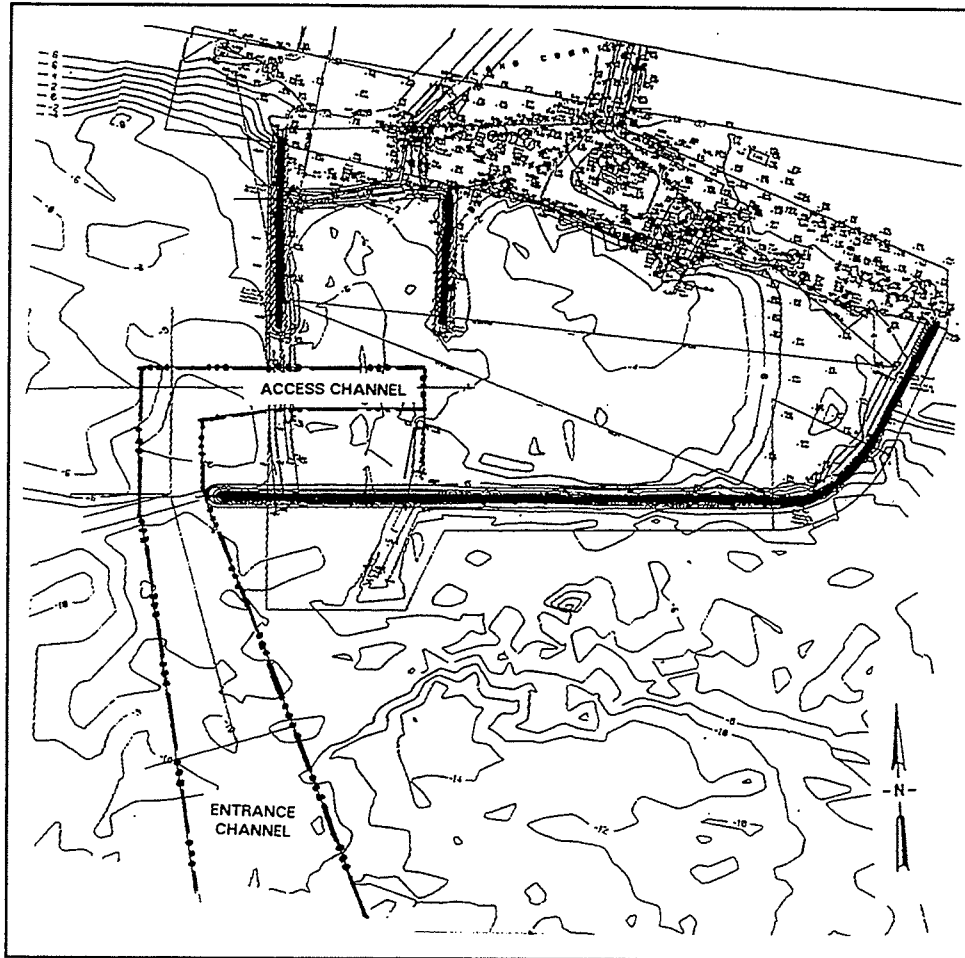

Figure 4. Plan 6

- e. Wave breaking effects in the entrance and harbor cannot be considered directly.
- f. No nonlinear effects are considered.
- g. Diffraction around structure ends is represented by diffraction around a blunt vertical wall with specified reflection coefficient.

Despite limitations imposed by the above assumptions, HARBD is considered suitable for meeting the numerical modeling objectives of the Kikiaola Harbor study. Development of the numerical model and test procedures is described in Chapter 3.

Response of the existing and alternative harbor plans to waves was studied using numerical model results. Harbor response to wind waves and swell (*short waves*) is presented in Chapter 4. The harbor short wave response is related to wave climate and to standard U.S. Army Corps of Engineers criteria in channels and berthing areas. Harbor oscillation characteristics (response to *long waves*)



are presented in Chapter 5. The long wave study included only the existing harbor and Plan 6.

Conclusions and recommendations are given in Chapter 6. This chapter is followed by references and appendices with detailed information supporting the main report and notation definitions.

## 2 Wind Wave and Swell Climate

---

### Sources

Four sources of wind wave and swell information were available to develop wave climate outside the harbor entrance, including three National Data Buoy Center (NDBC) buoys with open exposure to the south and the Wave Information Studies (WIS). WIS has hindcast waves over the Pacific Ocean and saved information at selected deepwater stations around the Hawaiian Islands. Buoy locations and corresponding WIS deepwater (Level 1) stations are shown in Fig. 5. The original WIS Pacific hindcast covered only the north Pacific (Corson et al. 1986). That study is presently being updated to extend coverage into the south Pacific as well. At the time of the Kikiaola Harbor study, only one year (1989) was completed. Because waves from the south Pacific are a critical part of the climate at Kikiaola Harbor, the 1-year updated WIS hindcast was used in this study in preference to the original WIS information.

### Deepwater Wave Climate

The deepwater WIS hindcast for 1989 was calculated in three steps, with each step giving increased refinement. The initial and coarsest step, Level 1, covered the entire Pacific Ocean basin with a grid spacing of 2.5 deg of latitude/longitude (Fig. 6). Information at a sequence of points enclosing U.S. Pacific coasts (shown in the figure) was saved to use as a boundary condition for a more refined, localized Level 2 grid. The Level 2 grid (Fig. 7), with mesh spacing 1.0 deg latitude/longitude, provided boundary conditions around the Hawaiian Islands for a Level 3 grid with 0.25-deg resolution (Fig. 8). An additional refinement was added for this study to represent the sheltering effects of the islands of Kauai and Niihau (the small island 15 miles southwest of Kauai) on the project site. This Level 4 grid had a resolution of 0.017-deg latitude/longitude and encompassed both Kauai and Niihau. Wind wave growth was included in Levels 1-3 and propagation effects were included in all levels of hindcast.

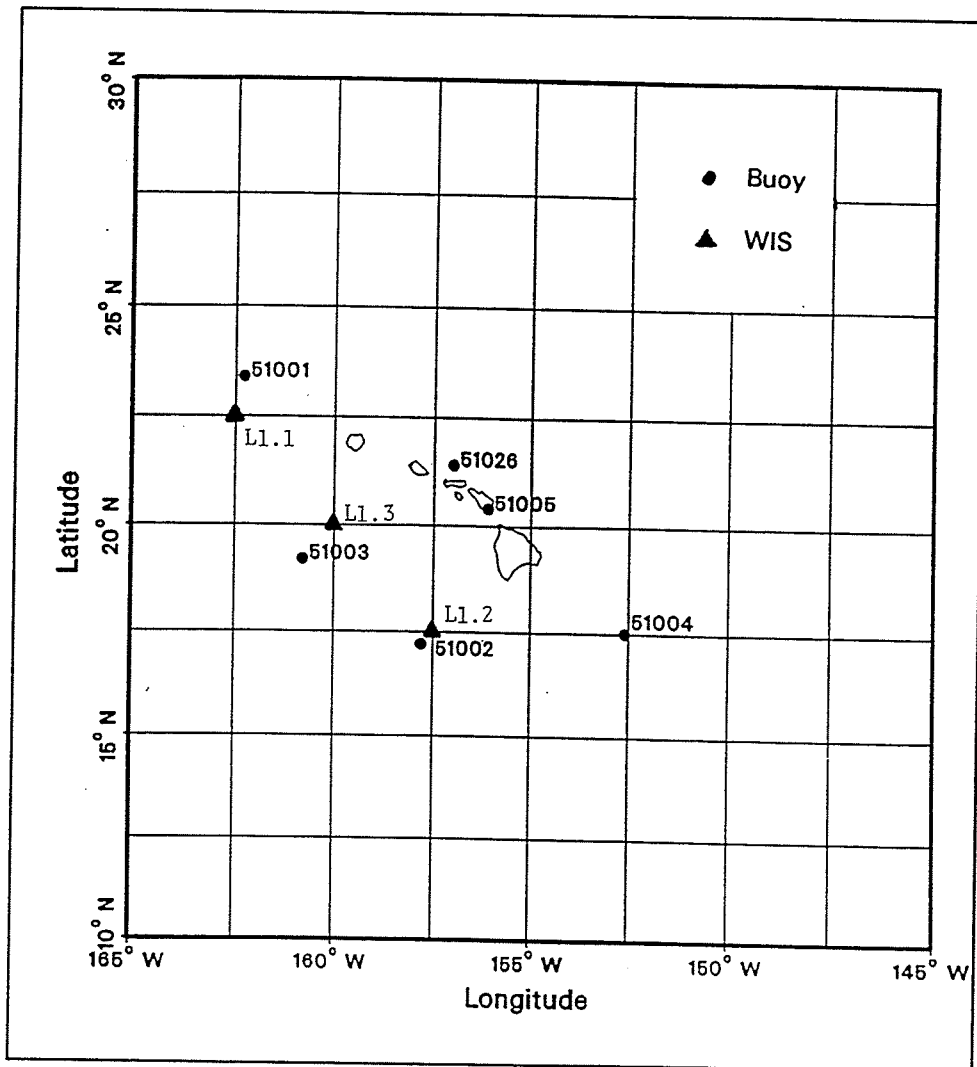

Figure 5. Location map for NDBC buoys and nearby WIS Level 1 stations

Hindcast waves during 1989 were compared with NDBC buoy measurements over the same time period. Each buoy was compared to the nearest WIS Level 1 station. Comparison statistics show root-mean-square (rms) differences and mean differences in significant wave height,  $H_s$ , and mean spectral wave period,  $T_m$  (Table 1). The biases are quite small and the rms differences are typical of a validated hindcast model (Brooks and Brandon 1995).

It is important to evaluate whether the time period of special hindcast is representative of the long term climate incident to the south coast of Kauai. Wave parameter summaries for the deepwater sources are compared in Table 2. Long term mean values of  $H_s$  for the three buoys are within 0.1 m of the corresponding WIS stations during 1989. Mean  $T_p$  values are within 1 sec. Standard deviations of  $H_s$  are similar between the buoys and WIS stations. Standard deviation of  $T_p$  is

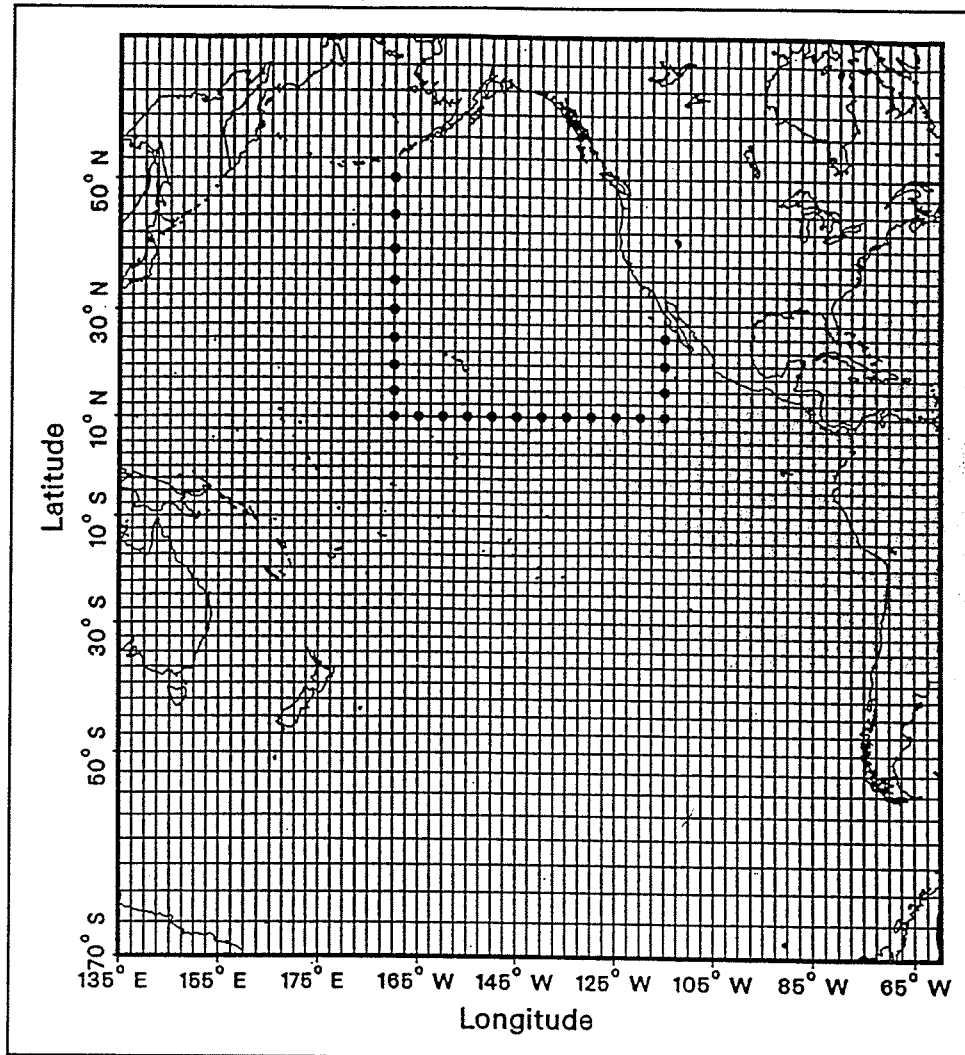

Figure 6. Location map for wave climate study, WIS Level 1 grid

Table 1 Comparison of WIS Level 1 Hindcasts and NDBC Buoy Data, 1989					
WIS Station	NDBC Buoy	RMS Difference		Bias	
		$H_s$ (m)	$T_m$ (sec)	$H_s$ (m)	$T_m$ (sec)
L1.1	51001	0.47	1.6	-0.06	-0.6
L1.2	51002	0.53	1.9	0.03	-0.4
L1.3	51003	0.51	1.6	0.10	-0.6

\* Calculation based on model minus measured values.

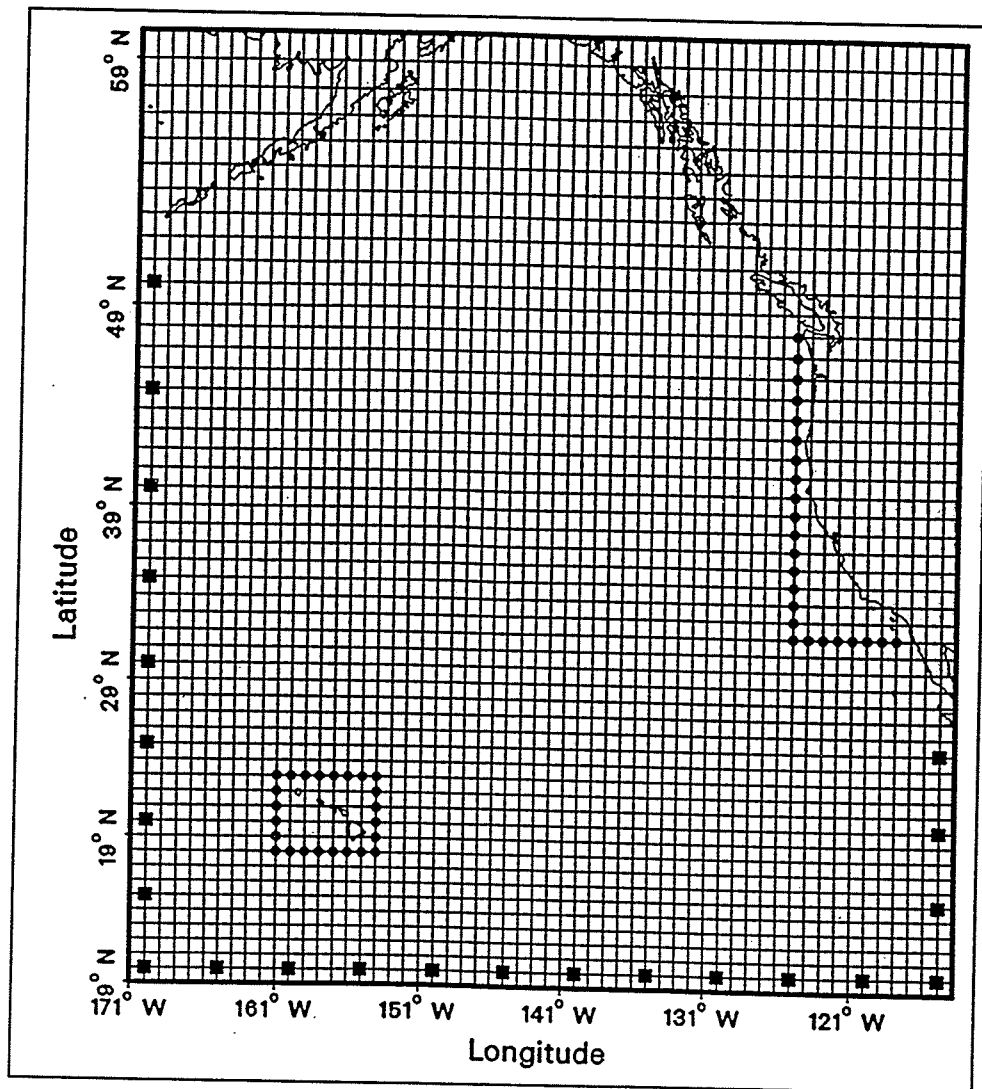

Figure 7. Location map for wave climate study, WIS Level 2 grid

somewhat greater for the buoys than for the WIS stations. Overall, the WIS information for the year 1989 appears representative of the long term climate.

Wave information from the special WIS Level 4 hindcast was saved at a deepwater point about one mile offshore from Kikiaola Harbor. Wave climate at this point is summarized in Figs. 9-11. Wave directions are predominantly from the south (180 deg) and west northwest (300 deg). Waves coming from the west, northwest, and north outside the islands are partially blocked by Niihau and western Kauai before they can arrive at Kikiaola Harbor. The concentration of waves coming from 300 deg indicates that a significant amount of wave energy is penetrating around and between the islands.

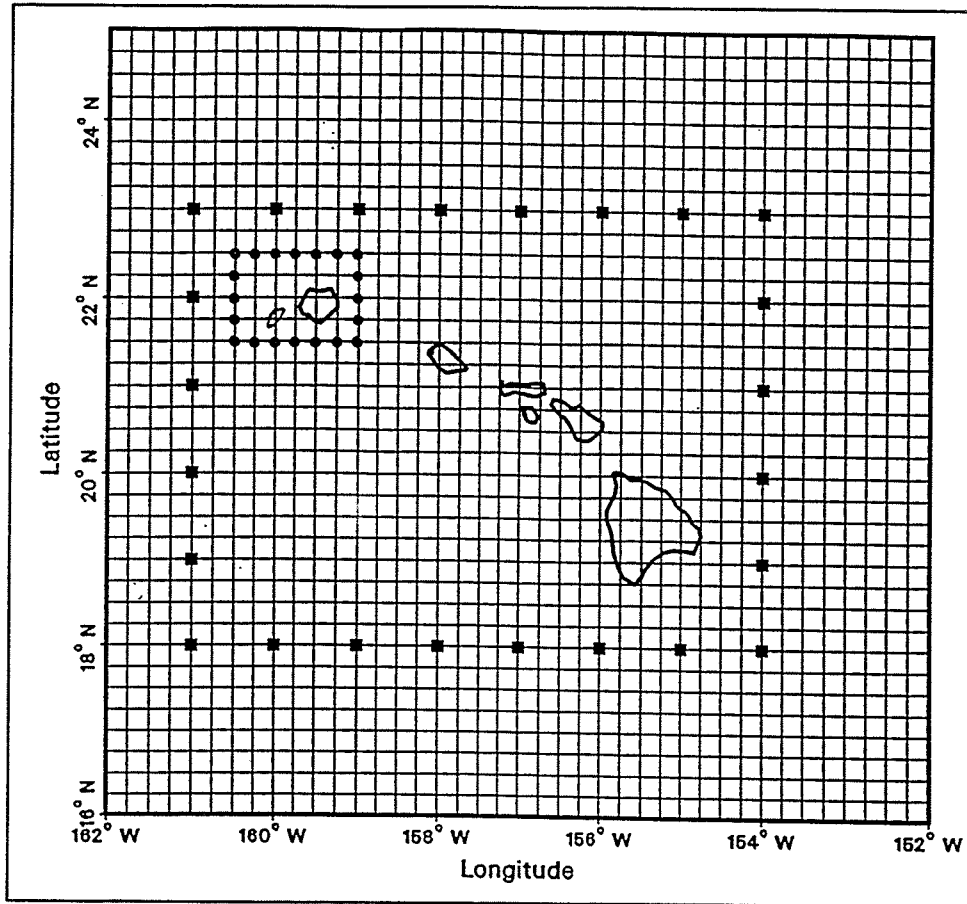

Figure 8. Location map for wave climate study, WIS Level 3 grid

Table 2 Summary Statistics, NDBC Buoys and WIS						
Statistical Parameter	Buoy 51001 <sup>1</sup>	WIS L1.1 <sup>2</sup>	Buoy 51002 <sup>3</sup>	WIS L1.2 <sup>2</sup>	Buoy 51003 <sup>4</sup>	WIS L1.3 <sup>2</sup>
Mean $H_s$ (m)	2.4	2.3	2.4	2.3	2.2	2.3
Standard deviation of $H_s$ (m)	0.9	0.6	0.7	0.5	0.7	0.6
Mean $T_p$ (sec)	10.5	11	10.2	11	10.4	11
Standard deviation of $T_p$ (sec)	2.9	2	2.8	2	2.9	1

<sup>1</sup> Data from Feb 81 through Dec 93  
<sup>2</sup> Data from Jan-Dec 89  
<sup>3</sup> Data from Sep 84 through Dec 93  
<sup>4</sup> Data from Nov 84 through Dec 93

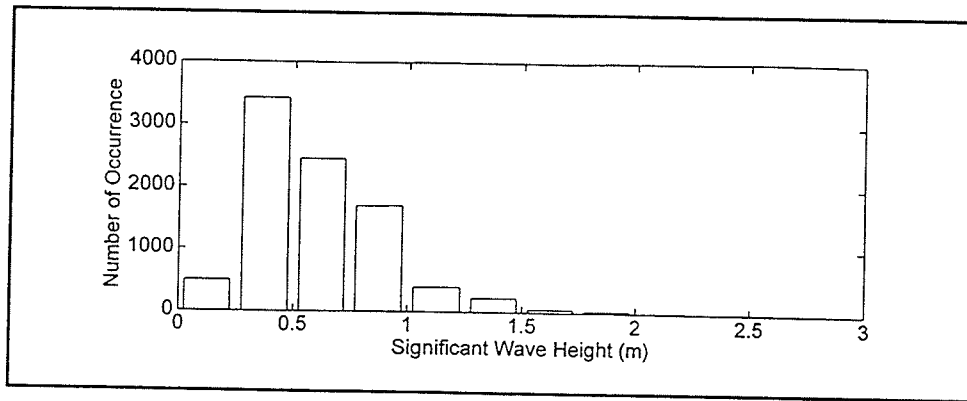

Figure 9. Deepwater wave climate,  $H_s$

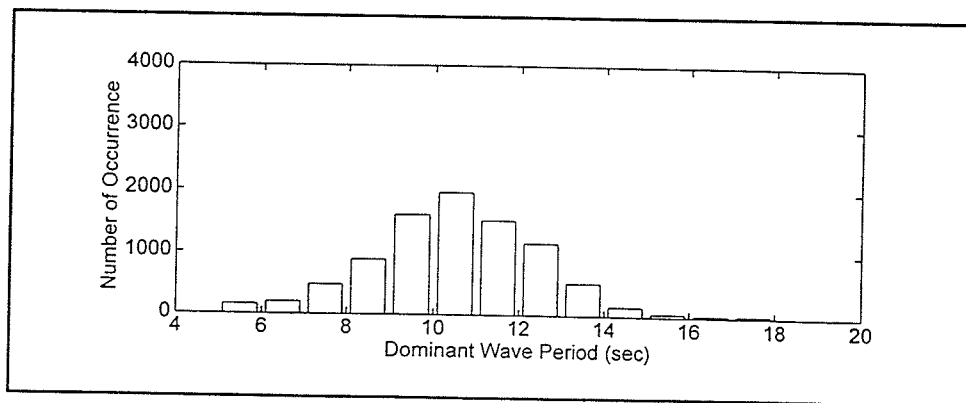

Figure 10. Deepwater wave climate,  $T_p$

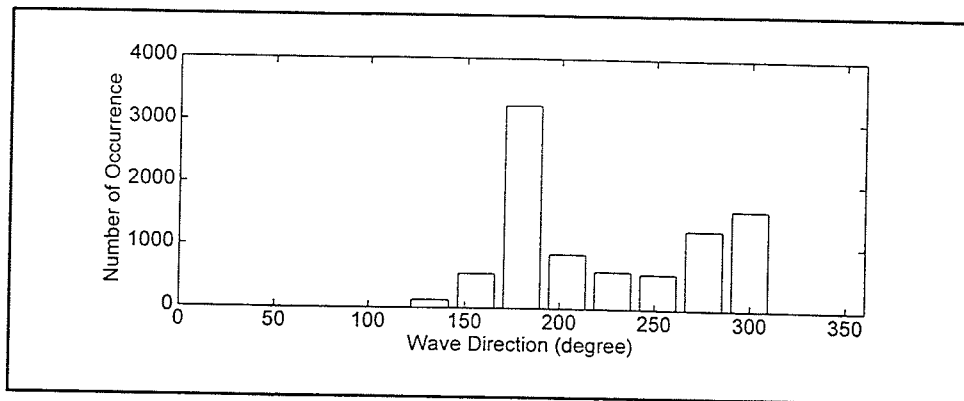

Figure 11. Deepwater wave climate,  $\theta_m$  (deg, coming from)

## Wave Climate at Kikiaola Harbor

The deepwater wave climate analysis suggests that data from the special one-year hindcast reasonably characterizes the wave climate immediately incident to Kikiaola Harbor. The hindcast information must be transformed into shallow water to provide wave climate at the seaward boundary of the HARBD model, in water depth of approximately 13 ft (4 m).

Initially, the nearshore transformation was attempted using the STWAVE and RCPWAVE models in the Automated Coastal Engineering System (ACES 2.0) (Leenknecht and Tanner 1996; Leenknecht, Tanner, and Sherlock 1997). The models gave inconsistent results over the highly irregular bathymetry near Kikiaola Harbor. Since bathymetry contours are fairly straight and parallel seaward of about 18 ft MLLW, the deepwater wave conditions were transformed to 13-ft depth using simplified refraction procedures. Each deepwater wave condition was represented as a combination of many multi-directional wave components. The amount of directional spreading was greatest for short period cases and gradually narrowed as  $T_p$  increased. Each component was refracted over straight, parallel bottom contours with an east-west orientation. Components were recombined in 13-ft depth to give a shallow water significant wave height and dominant direction.

Wave climate in 13-ft depth seaward of the harbor is summarized in Figs. 12 and 13. The distribution of wave periods,  $T_p$ , is not shown because it is basically unchanged in the transformation process. Wave directions are concentrated between the south and south southwest.

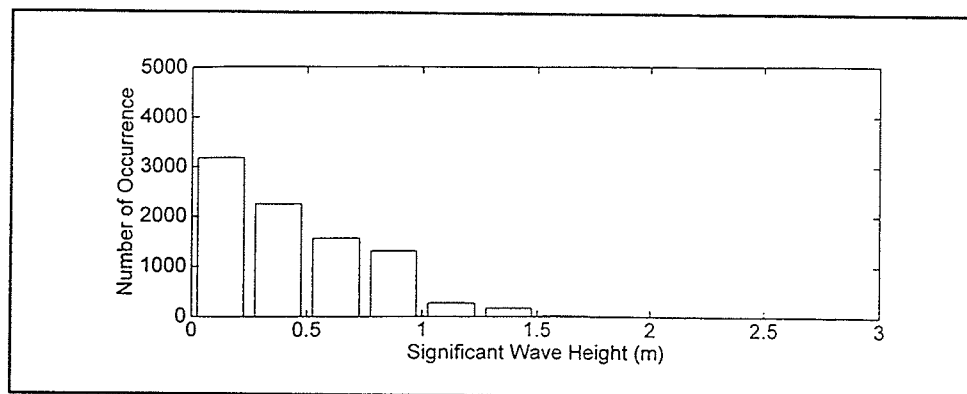

Figure 12. Harbor entrance wave climate,  $H_s$ .



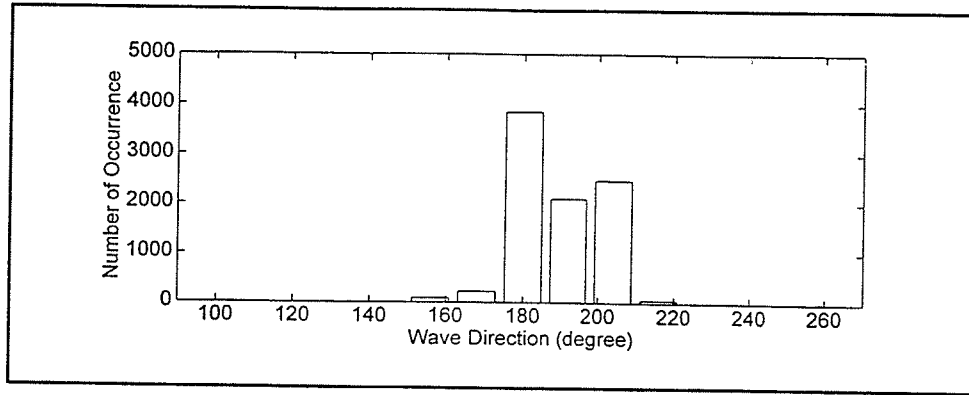

Figure 13. Harbor entrance wave climate,  $\theta_m$  (deg, coming from)

# 3 Numerical Model

---

## Objectives and Approach

The numerical model study had two objectives:

- a.* Advance understanding of the existing harbor wave response.
- b.* Evaluate the effect of proposed harbor modifications on wave response.

The harbor wave response model is presented in the following section, including a brief description of the HARBD model and implementation of the model at Kikiaola Harbor. The final section of this chapter describes the test procedures and calculations.

As part of the test procedures, a suite of incident wave conditions must be specified at the seaward boundary of the area covered by HARBD. Incident short waves are determined by consideration of transformed WIS information outside the harbor. Incident long waves are specified over a broad range of frequencies but only a normally-incident direction to identify possible harbor resonant responses.

## Model Description

### Model Formulation

The numerical wave model HARBD is a steady state hybrid element model used in the calculation of linear wave response in harbors of varying size and depth (Chen 1986, Chen and Houston 1987, and Lillycrop and Thompson 1996). The model as applied in this study is described in a recent report on Kahului Harbor, Maui, Hawaii (Thompson et al. 1996). An overview of the model and its applications is given by Thompson and Hadley (1995).

The principal output information available from HARBD consists of amplification factor and phase at each node in the numerical grid. These are defined as

$$A_{amp} = \frac{|a|}{|a_i|} = \frac{|H|}{|H_i|} = |\phi| \quad (1)$$

$$\psi = \tan^{-1} \left[ \frac{Im\{\phi\}}{Re\{\phi\}} \right]$$

where  $A_{amp}$  = amplification factor,  
 $a, a_i$  = local and incident wave amplitudes,  
 $H, H_i$  = local and incident wave heights,  
 $\phi$  = velocity potential,  
 $\psi$  = phase relative to the incident wave,  
 $Im\{\phi\}$  = imaginary part of  $\phi$ ,  
 $Re\{\phi\}$  = real part of  $\phi$ .

Amplification factors are easily interpreted. Phases are helpful in viewing wind wave and swell propagation characteristics and in interpreting standing wave patterns. In long wave applications, phases prove useful for determining relative phase differences within the harbor, interpreting harbor oscillation patterns, and identifying potentially troublesome nodal areas.

### Spectral Adaptation

HARBD computes harbor response to specified wave period and direction combinations. However the model is often used to approximate irregular wind wave and swell behavior, as in physical model tests with irregular waves and all field cases. More realistic numerical model simulations can be obtained by linearly combining HARBD results from a range of regular wave frequencies and directions in the irregular wave spectrum. With proper weighting, regular wave results represent a desired spectral distribution of energy.

Spectral adaptation of the HARBD model is done as a post-processing step using the standard, regular wave output from the model. For a given set of incident wave directions representing the range of possible approach directions, HARBD is run for a number of wave periods spread between the shortest period consistent with grid resolution constraints and the longest swell period of interest. Details of the procedure are given by Thompson et al. (1996).

The effective amplification factor at each node is computed as

$$(A_{amp})_{eff} = \sqrt{\sum_{k=1}^{N_T} \sum_{n=1}^{N_D} w_n w_k A_{amp}^2(f_k, \theta_n)} \quad (2)$$

where  $(A_{amp})_{eff}$  = effective, or spectral, amplification factor at a node  
 $A_{amp}(f_k, \theta_n)$  = nodal amplification factor for HARBD computational frequency  $f_k$  and direction  $\theta_n$   
 $N_T$  = number of HARBD computational wave periods  
 $N_D$  = number of HARBD computational wave directions

- $w_k$  = weighting factor for  $k$ 'th HARBD computational frequency  
 $w_n$  = weighting factor for  $n$ 'th HARBD computational direction

### Finite Element Grids

The finite element numerical grid depicting existing conditions at Kikiaola Harbor was created using WES's finite element grid development software (Turner and Baptista 1993) (Figure 14). The grid covers the entire Kikiaola Harbor area and extends somewhat seaward into Waimea Bay. The land boundary was matched to recent POD surveys of the harbor. Grid element size is based on the criterion of 6 elements per wavelength (the minimum recommended resolution with HARBD) for a 6-sec wave in 4-ft water depth. Depths for areas of interest in the existing and plan harbors generally exceed 4 ft. Some areas of interest in the existing harbor are shallower than 4 ft (even at a high tide water level of +1 ft MLLW), but it was impractical to make the grid significantly finer. The grid was expected to be adequate for the existing harbor, as well as the plan harbors. For the longer period waves, the grid gives a high degree of resolution. Grid characteristics are summarized in Table 3.

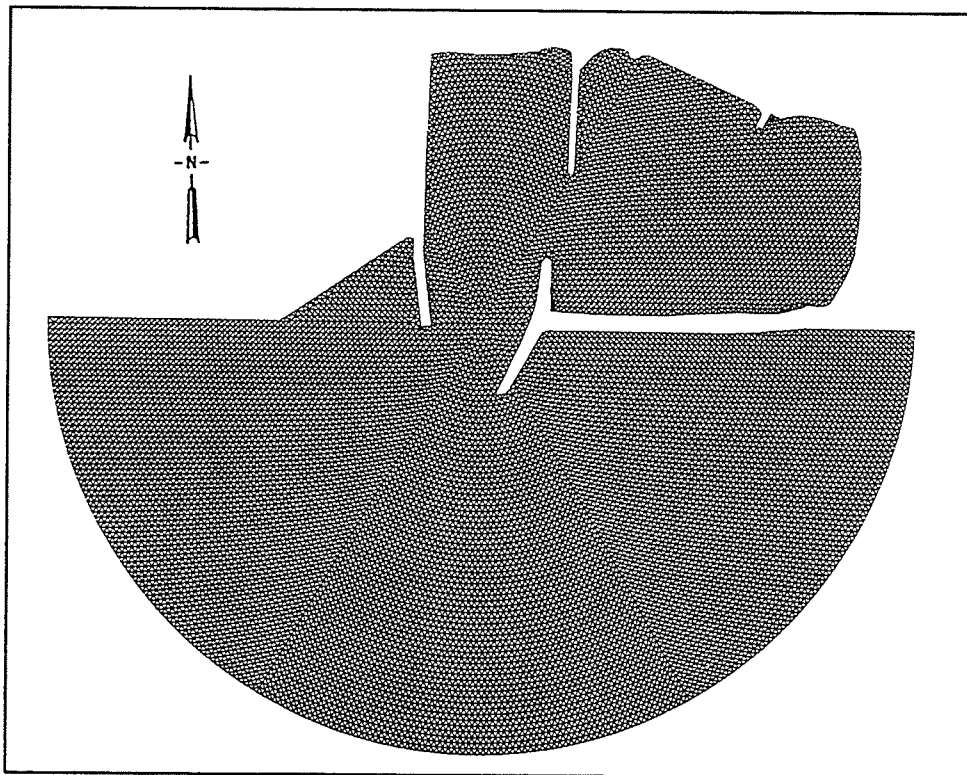

Figure 14. Grid of existing harbor

<b>Table 3 Grid Sizes</b>					
<b>Harbor Plan</b>	<b>Number of:</b>				<b>Length of Typical Element (ft)</b>
	<b>Elements</b>	<b>Nodes</b>	<b>Solid Boundary Elements</b>	<b>Semicircle Boundary Nodes</b>	
Existing	24227	12461	462	232	11
Plan 1	24524	12602	447	232	11
Plan 6	27345	14014	450	232	11

The radius of the seaward semicircle is 854 ft. This is equivalent to 2.1 and 8.1 wavelengths for the longest and shortest short wave periods considered, assuming a representative water depth of 11 ft (10-ft depth below MLLW plus 1-ft tide). The semicircle size and location were chosen to include both breakwaters and the immediate nearshore area. The semicircle extends sufficiently far seaward to cover the most important nearshore bathymetry while maintaining a reasonable number of grid elements.

Bathymetric data were obtained from recent (summer of 1996) POD surveys of the harbor area and extending seaward to the 300 ft depth contour. NOAA hydrographic chart 19386 provided a useful reference for bathymetry outside the survey area. Digitized depths were transferred onto the finite element grid using the WES grid software package. A contour plot of bathymetry in the existing harbor is given in Figure 15. Bathymetry was modified for Plans 1 and 6 to include project depths in the entrance and access channels (Appendix A). Per discussions with POD, the plan bathymetry also includes deepening of the harbor areas expected to be used for mooring (Fig. 16).

Reflection coefficients,  $K_r$ , are needed for all solid boundaries. For the short wave tests,  $K_r$  values were estimated from existing Corps of Engineers guidance, photos, and field notes from a May 1996 site visit by WES and POD representatives, and past experience. The solid boundary was divided into nine zones and a reflection coefficient was estimated for each zone (Figure 17). Reflection coefficients range from 0.05 for the shallow, gently sloped beach along the southeast shore of the existing harbor to 0.5 for all breakwater areas. Similar reflection coefficients were used in the plan harbors. Additional parameter values used in the numerical model are summarized in Table 4.

Different parameters are used for the long wave tests. The reflection coefficient was set to 1.0 for all solid boundaries, since long waves generally reflect very well from a coastal boundary. A reflection coefficient of zero was used along the open boundary west of the west breakwater. Long waves are more

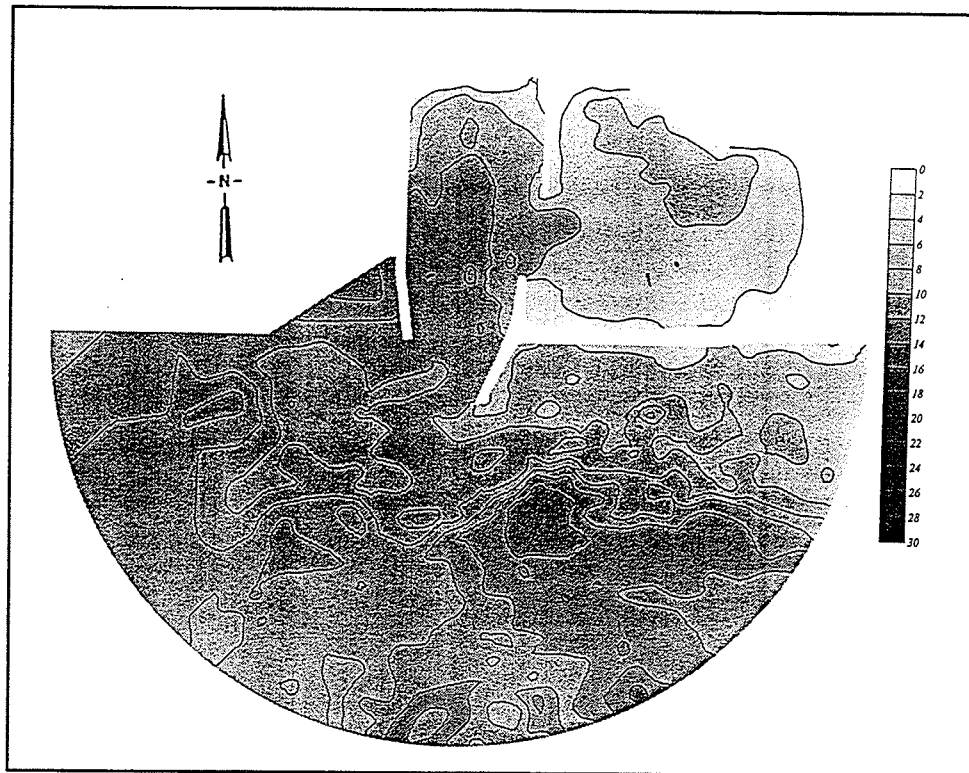

Figure 15. Bathymetry, existing harbor

Table 4 Parameter Values Used in HARBD		
Parameter	Value	
	Short Waves	Long Waves
Bottom friction, $\beta$	0.0	0.032
Coastline reflection, $K_{r, coast}$	1.0	1.0
Depth in infinite region, $d_{inr}$	10 ft below MLLW	10 ft below MLLW

affected by bottom friction than short waves, so a value of  $\beta$  greater than zero is appropriate. A value of  $\beta=0.032$  was selected, based on experience calibrating to field data at other sites, principally Kahului Harbor (Thompson et al. 1996). This and other long wave parameters are given in Table 4.



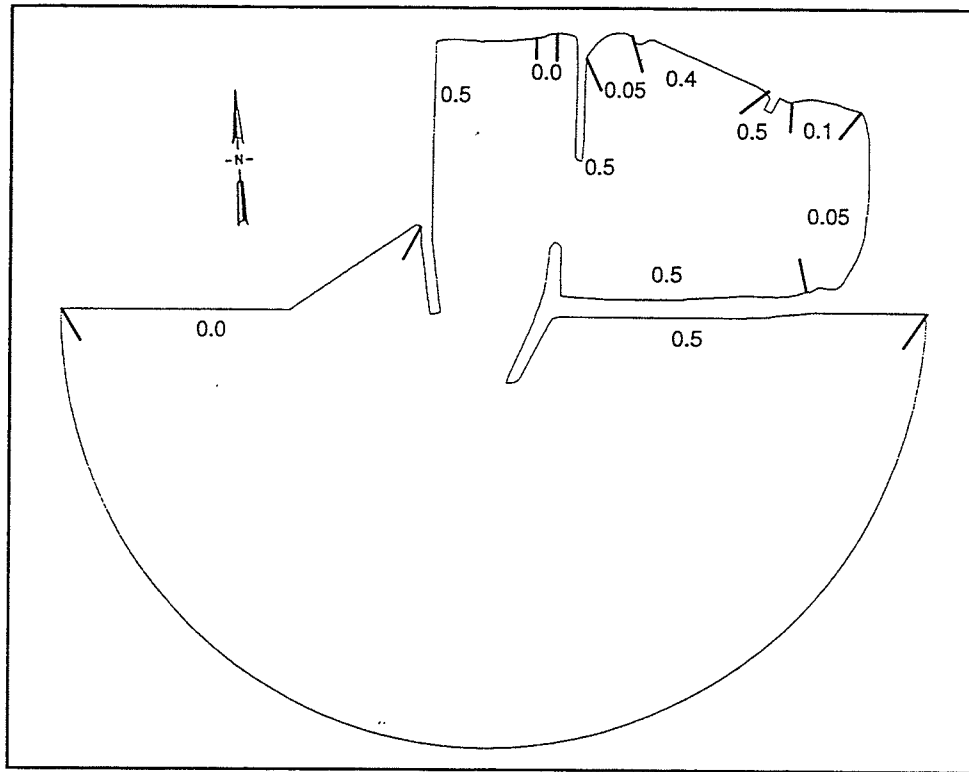

Figure 17. Wave reflection coefficient values, short waves, existing harbor

## Test Procedures and Calculations

### Incident Wave Conditions

A range of short and long wave conditions incident to Kikiaola Harbor was considered. A representative range of wave periods and directions which could cause damaging conditions inside the harbor was included, based on WIS information.

The short wave periods and approach directions considered are given in Table 5. These conditions provide reasonable coverage of the WIS information for the area, summarized in Figures 10, 12 and 13. The shortest period represents a local

Wave Period (sec)		Wave Direction (deg, coming from)
6	15	164
7	16	184
8	17	204
9	18	
10	19	
11	20	
12	21	
13	22	
14		



sea condition and the longest represents a very long swell condition. Directions were chosen to include likely approach directions to the harbor entrance and to give adequate representation of the directional spectrum in post-processing. Test directions were straight into the harbor (184 deg) and 20-deg increments to either side (coming from, relative to true north). Incident wave directions and the angular orientation of the seaward semicircular model boundary are illustrated in Figure 18.

For the study of existing harbor conditions and comparison of alternatives, HARBD was run with the full set of short wave periods and directions in all possible combinations. Model results were then evaluated for directional spectra with  $T_p$  and  $\theta_m$  values as follows: periods of 6, 7, ..., 20 sec and directions of 150, 160, ..., 210 deg azimuth (coming from). These values cover the range of conditions in the WIS nearshore information.

Incident long wave conditions considered are given in Table 6. A fine resolution in wave frequency was used over the full range of possible resonant conditions to insure that all important peaks were identified. A total of 451 periods was considered. Only one approach direction is included, since past studies have indicated that harbor response is relatively insensitive to incident long

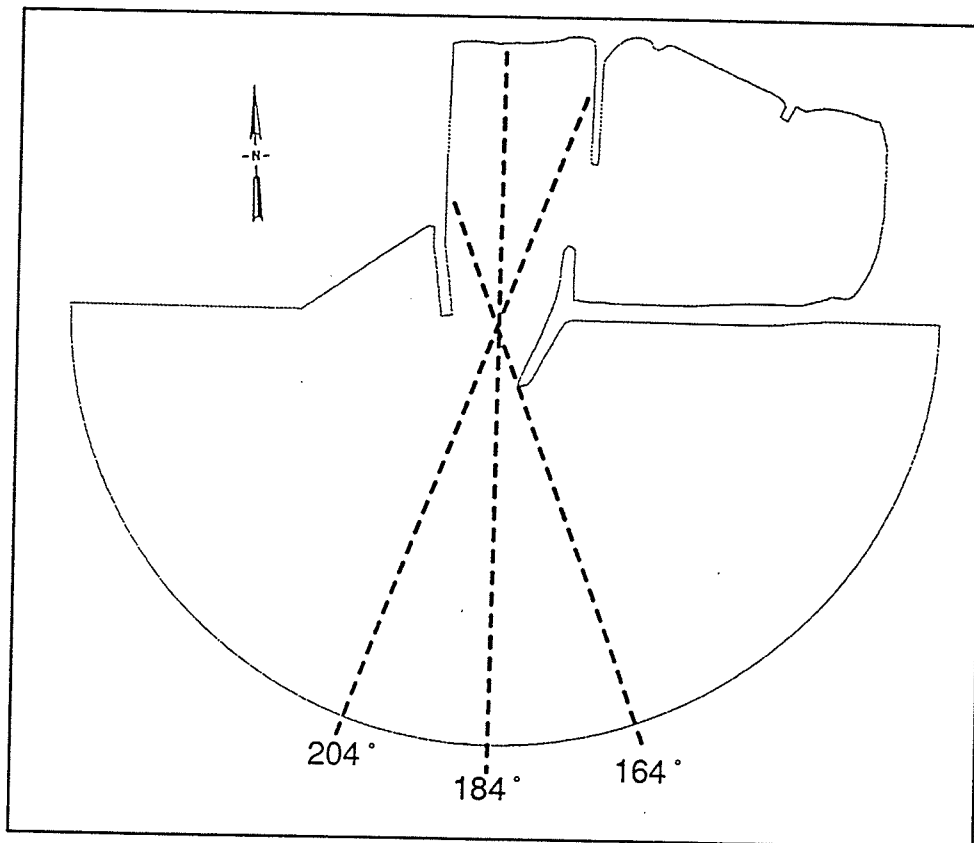

Figure 18. Incident wave directions

wave direction. This direction represents a wave directly approaching the harbor entrance from deep water.

One water level was tested. The tide range at Kikiaola Harbor is relatively small, with a mean range of about 1 ft. Harbor wave response is unlikely to vary much with water level over this tidal range. The water level was selected as +1.0 ft above mean lower low water, representative of a high tide condition.

### Calculation of Spectra

Numerical model test results for short waves in Kikiaola Harbor are all based on spectral post-processing of the initial HARBD runs. Hence, short wave amplification factors are all in the form of  $(A_{amp})_{eff}$  in Eq. 2. This approach requires, first, that HARBD be run with the range of wave periods and directions to be considered in the spectral calculations.

Second, values of peak wave period,  $T_p$ , corresponding to the peak spectral frequency; wave approach direction,  $\theta_m$ ; spectral peak enhancement factor,  $\gamma$ ; and directional spreading factor,  $s$ , must be specified. The  $T_p$  and  $\theta_m$  values were chosen to represent wind wave and swell conditions at the harbor, as discussed in the section on Incident Wave Conditions. Values for  $\gamma$  and  $s$  were approximated as discussed by Thompson et al. (1996).

### Output Basins

In order to get special coverage of areas where harbor traffic would most likely be affected by wave conditions, between 15 and 25 output locations or "basins" were selected to cover each harbor layout. A basin is a small cluster of elements over which the HARBD response is averaged to give a more representative output. Whenever possible basins were positioned to coincide with basins of other plans, particularly those of the existing harbor (Appendix A). Each basin in this study contains 12-15 elements. HARBD output information was saved at each of these locations in addition to the detailed output at nodes.

<b>Wave Period (sec)</b>	<b>Wave Direction (deg, coming from)</b>
25.00	184
25.06	
25.13	
...	
500.0	

<sup>1</sup> Frequency increments are 0.0001 Hz for periods of 25-80 sec and 0.00006 Hz for periods of 80-500 sec.

## 4 Harbor Response to Wind Waves and Swell

---

Numerical model studies of the harbor response to wind waves and swell were directed primarily toward assessing the operational performance of alternative harbor modifications. Results are summarized in this chapter. Amplification factors are presented in the following section. The final section gives  $H_s$  values exceeded 10 percent and 1 percent of the time, a result more directly applicable to operational performance. The  $H_s$  values are derived from a combination of amplification factors from the numerical model and wave hindcast information outside the harbor. They are compared to operational criteria for wind waves and swell.

### Amplification Factors

Amplification factors, representing directionally-spread short wave spectra in the form of  $(A_{amp})_{eff}$  in Eq. 2, were calculated for a variety of wind wave and swell conditions. Figure 19 illustrates the behavior of a common wave condition at Kikiaola Harbor, a 12-sec wave approaching from 200 deg azimuth. Contour plots of  $(A_{amp})_{eff}$  for the existing and plan harbors are shown. The plots indicate reduced wave heights in the entrance channel near the main breakwater entrance in the plan conditions, as compared to the shoaled entrance in the existing harbor. Also, the plans are more effective than the existing harbor in affording protection to wharf and mooring areas from this wave condition.

Plots of wave phase ( $\psi$  in Eq. 1) are included in Figure 19. Since the phase lines show the alignment of wave crests, they give a visual representation of diffraction and shoaling effects on wave direction and length as the 12-sec waves interact with harbor structures and bathymetry. For clarity of presentation, the phase plots were taken from 12-sec *regular* wave results.

For a more concise comparison between the existing harbor and alternative plans, average values of  $(A_{amp})_{eff}$  were computed for each basin across wave periods ranging from 6 sec through 20 sec. Figure 20 illustrates results for the existing harbor and two plans. The  $(A_{amp})_{eff}$  changes progressively as incident wave direction changes. As would be expected, amplification tends to be greater for directions of more direct approach to the basins. As illustrated in Figure 19, the wind wave and swell response in the harbor is basically a result of diffraction

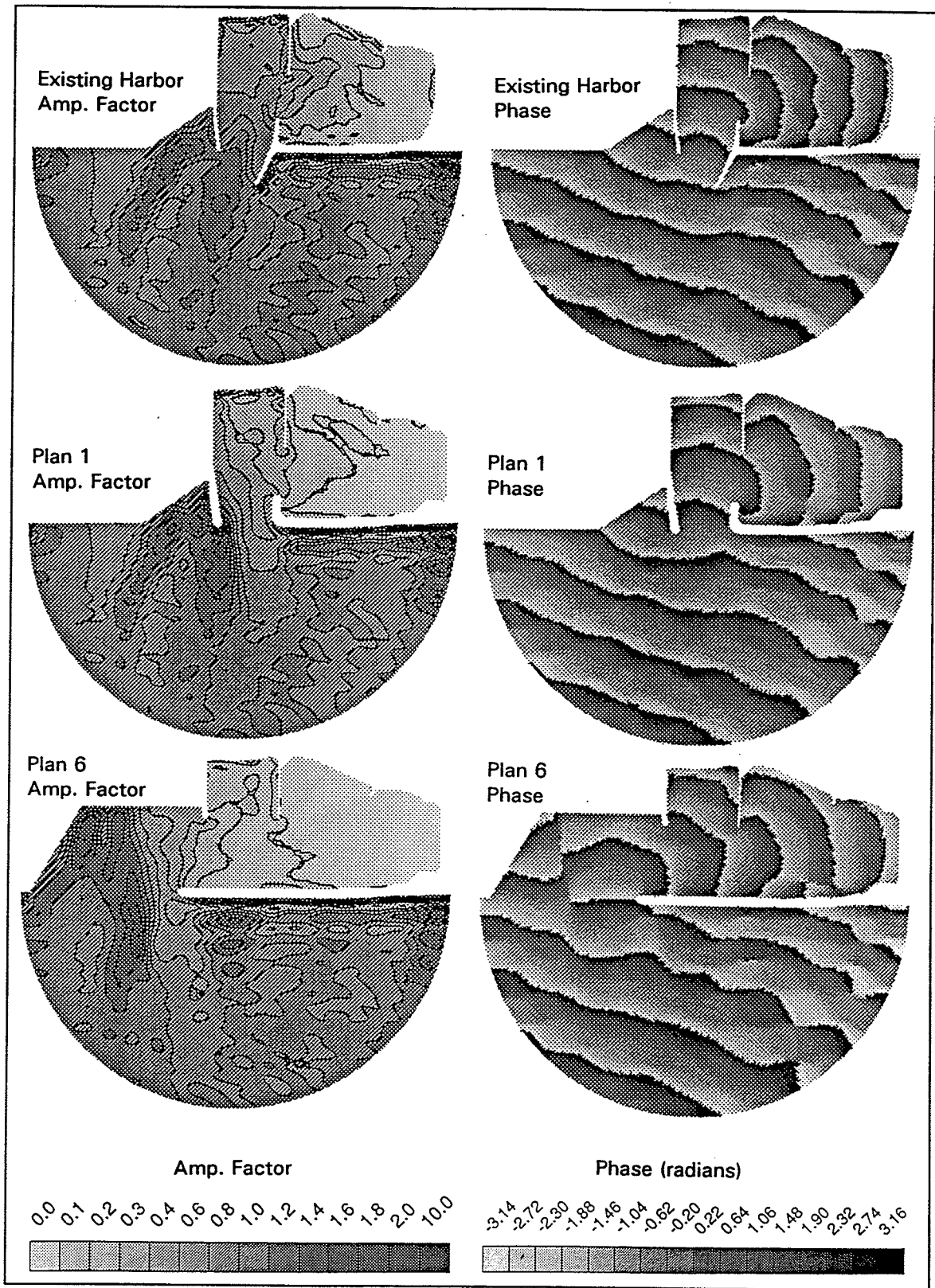

Figure 19. Amplification factor and phase contours, 12-sec wave period, 200-deg direction

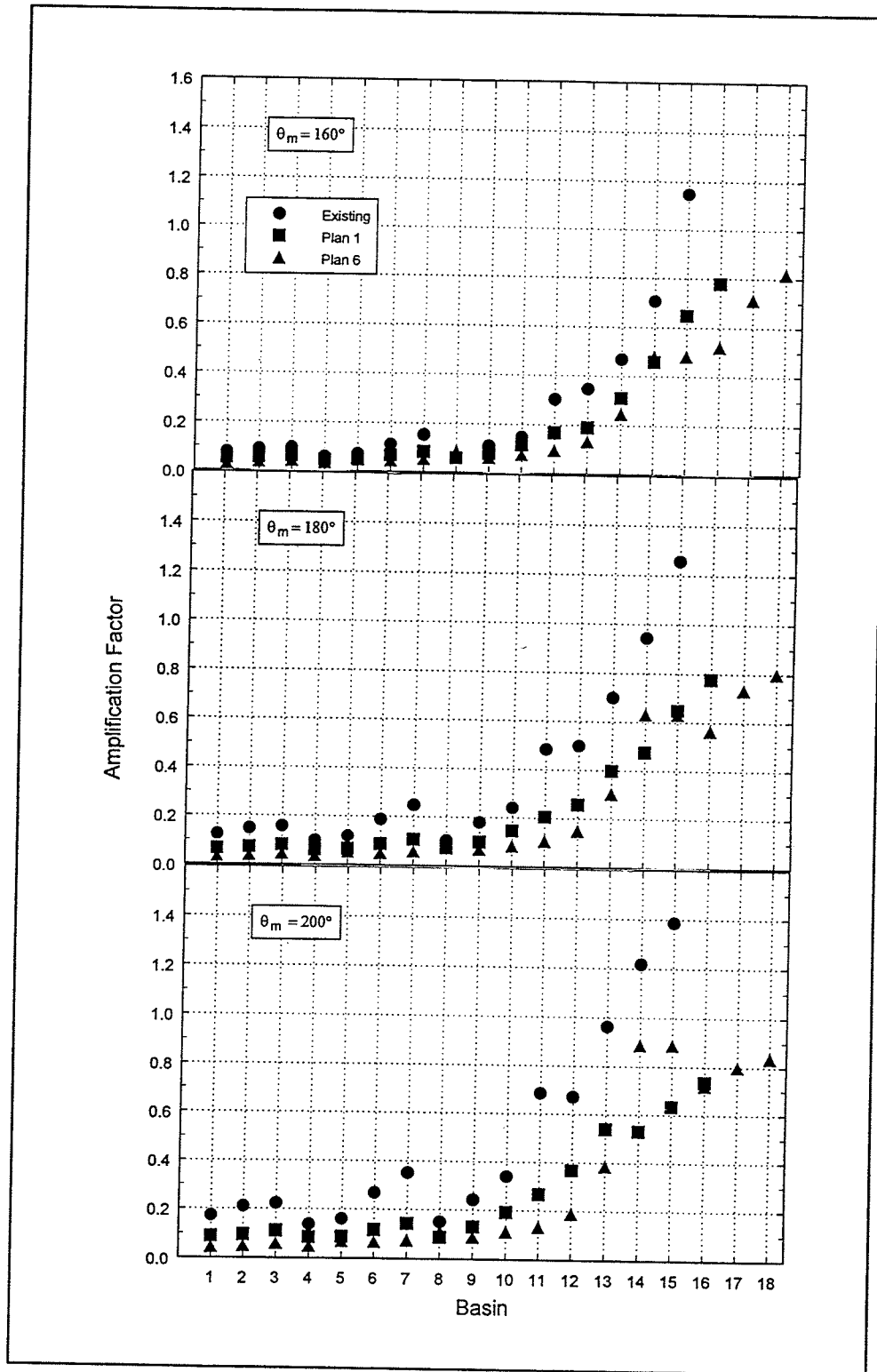

Figure 20. Comparison of  $(A_{amp})_{eff}$  averaged over periods of 6-20 sec

through the breakwater gap. Boundary reflection characteristics have only a localized effect on the waves. Complete results of  $(A_{amp})_{eff}$  averaged over wave period are given in Appendix B.

An even more concise description of  $(A_{amp})_{eff}$  at each basin can be obtained by considering wave climate as well. A climate-based amplification factor is calculated for each basin as

$$(A_{amp})_{climate} = \sum_{j=1}^{N_T} \sum_{k=1}^{N_D} ((A_{amp})_{eff})_{jk} \frac{N_{jk}}{N_{total}} \quad (3)$$

where

$jk$  = indices denoting the  $j^{th}$  period interval and  $k^{th}$  direction interval, where the intervals are based on the incident wave conditions in Table 5

$((A_{amp})_{eff})_{jk}$  = spectral amplification factor for the  $j^{th}$  period and  $k^{th}$  direction

$N_{jk}$  = number of incident wave conditions with  $T_p$  and  $\theta_m$  in the  $j^{th}$  and  $k^{th}$  period and direction intervals

$N_{total}$  = total number of incident wave conditions

This climate-based amplification factor is given in Appendix B for every basin and harbor plan.

Amplification factors for basins in the shallower harbor areas can be expected to be conservative because bottom friction was set to zero in the HARBD model runs. This choice of bottom friction is standard procedure for wind wave and swell simulations and it has served well in many previous studies. However, in the study of Kahului Harbor, it appeared clear that the lack of bottom friction was significantly affecting model results in one very shallow basin (Thompson et al. 1996). Some very shallow basins in Kikiaola Harbor may be similarly affected. A trial run of the existing harbor with  $\beta=0.032$  indicated the extra complications of using bottom friction (which makes amplification factors dependent on wave incident wave height as well as period and direction) were not warranted in this study.

## Evaluation Against Operational Criteria for Wind Waves and Swell

Standard operational criteria used by the U.S. Army Corps of Engineers (USACE) for wind waves and swell in shallow draft harbors are:

- wave height in berthing areas will not exceed 1 ft more than 10 percent of the time
- wave height in entrance and access channels and turning basins will not exceed 2 ft more than 10 percent of the time

Wave heights for assessing the USACE criteria were computed by combining the time history of wave hindcast information with harbor model results to create a time history of wave heights at each harbor basin. For each WIS hindcast time, the corresponding wave height at a harbor basin is

$$(H_s)_{harbor} = (A_{amp})_{eff} \times (H_s)_{WIS} \quad (4)$$

where

$(H_s)_{harbor}$  = significant wave height at a harbor basin

$(A_{amp})_{eff}$  = spectral amplification factor interpolated between values for periods and directions in Table 5 to represent  $T_p$  and  $\theta_m$  at the seaward HARBD boundary

$(H_s)_{WIS}$  = significant wave height at the seaward HARBD boundary

The 12-month time history of  $(H_s)_{harbor}$  at each basin was sorted into descending order and the value of  $H_s$  which was exceeded 10 percent of the time was identified. The  $H_s$  value exceeded 1 percent of the time was also identified. The  $H_s$  with 1 percent exceedance relates to a more demanding operational condition, which may also be helpful in assessing performance of the harbor plans.

Significant wave heights exceeded 10 percent of the time are less than 1 ft at the wharf in the existing and plan harbors (Figure 21). The USACE criteria for acceptable berthing areas and channels are shown in the figure as solid lines. Wave conditions in the inner channel satisfy the USACE criterion in the existing and plan harbors. However, wave conditions in the outer portion of the existing channel exceed the criterion. Wave conditions in the outermost portions of the channel in Plans 1 and 6 slightly exceed the USACE criterion. In conjunction with the increased width of the outermost portion of the plan channels, the small exceedance of the USACE criterion is unlikely to interfere with safe navigation.

The  $H_s$  values exceeded 1 percent of the time are considerably higher than those exceeded 10 percent of the time, but show similar relative trends (Appendix B). The existing wharf area still falls below the 1-ft wave height threshold. Values of  $H_s$  with 10- and 1-percent exceedance are tabulated in Appendix B.

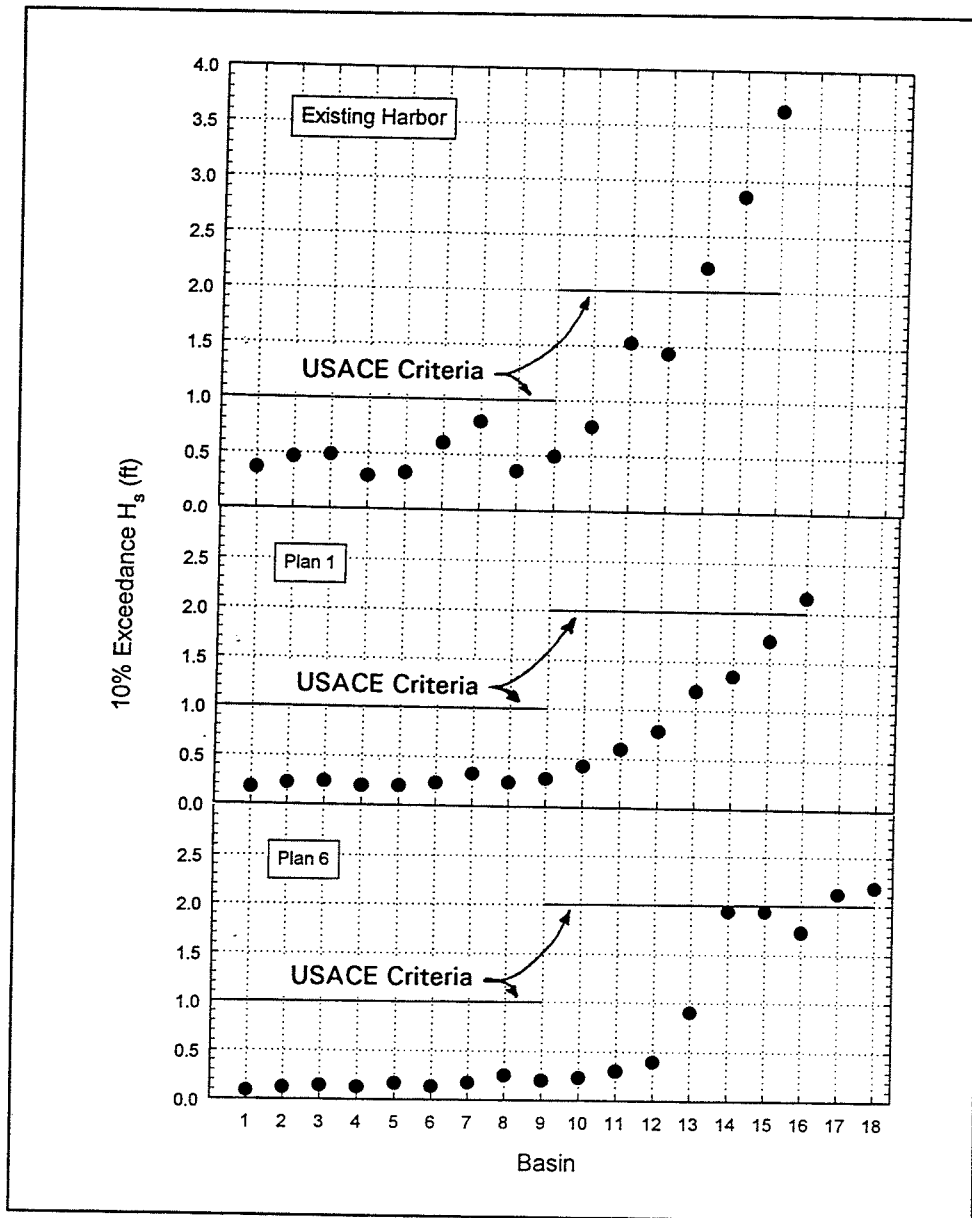

Figure 21. Comparison of  $H_s$  exceeded 10 percent of the time



# 5 Harbor Oscillations

To evaluate harbor resonance characteristics, the HARBD numerical model was run for the existing harbor and Plan 6. Incident long wave periods ranged from 25 sec to 495 sec in very fine increments, as discussed in Chapter 3. These evaluations were included because oscillations are an important part of interpreting the existing harbor wave response, and modifications to the harbor can potentially lead to operational problems due to harbor oscillations. Amplification factor results are presented in the following section. The operational significance of the results is discussed in the final section.

## Amplification Factors

Amplification factors for the long waves involved in harbor oscillation behave differently than those for wind waves and swell. Long waves, because of their length relative to harbor dimensions and their reflectivity from harbor boundaries, form *standing wave* patterns in the harbor. Standing wave behavior in a simple closed basin of uniform depth is illustrated in Figure 22. In the fundamental mode of oscillation, *antinodes* occur at both basin walls and a *node* midway between walls. Second and third modes of oscillation are also illustrated. Antinodes always occur at the walls. Additional antinodes and nodes occur at regular intervals between walls, with the number of antinodes and nodes dependent on the mode of oscillation.

The water surface in a standing wave has its greatest vertical motion at antinodes. There is no vertical movement at an ideal node, but horizontal velocities reach a maximum there. In terms of amplification factors, this behavior gives large values of  $A_{amp,t}$  at antinodes and small values around

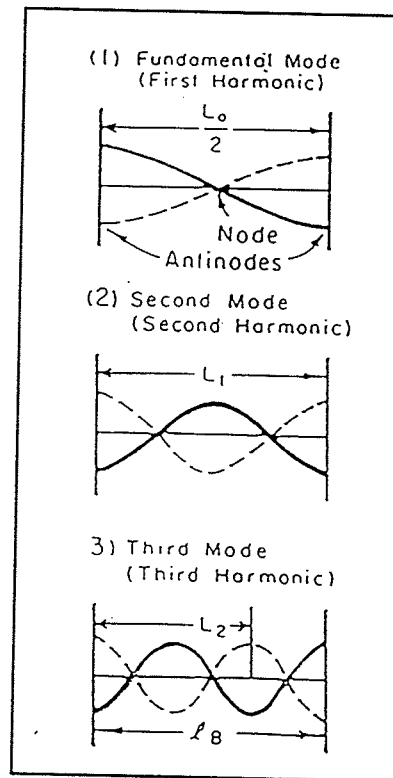

Figure 22. Harbor oscillation definitions

nodes (the notation  $A_{amp,l}$  is used to denote *long* wave amplification factors). Contrary to wind waves and swell, small values of  $A_{amp,l}$  are not necessarily indicative of a tranquil harbor area.

Phases in a standing wave also behave differently than for typical wind waves and swell. For example, the water surface in the fundamental mode of oscillation in Figure 22 simultaneously reaches a maximum at every point to the left of the node. These points are all in phase. At the same time, every point to the right of the node reaches a minimum value. These points are also in phase with each other but exactly out of phase with the points to the left of the node. Thus phases in a simple standing wave are constant between an antinode and node. They quickly change by 180 deg (or  $\pi$  radians) across the node and remain constant up to the next node or boundary.

Because of the nature of long wave behavior, harbor oscillation studies must include consideration of likely antinode locations, particularly harbor corners. Several output basins were added to those used for wind waves and swell, as shown in Appendix A.

Amplification factors for basins in the existing harbor and Plan 6 are shown as a function of wave frequency in Appendix C. Some frequencies produce a strong resonant amplification, with peak amplification factors between about 2 and 7. Some of the same resonant frequencies appear at several basins though the strength of amplification can vary considerably between basins. A large peak at very low frequency (0.00214 Hz or 470-sec period in existing harbor; 0.00274 Hz or 365-sec period in Plan 6) shows at every basin and plan. This peak represents the Helmholtz (or *grave*) mode of oscillation, in which the entire harbor rises and falls in unison. Phase is constant over the whole harbor. Computed values of  $A_{amp,l}$  over the range of frequencies up to and including the Helmholtz mode were divided by two because these oscillations affect the entire numerical model domain and would otherwise give a distorted view of the harbor effect.

Amplification factor and phase contour plots for six of the dominant resonant peaks in the existing harbor (excluding Helmholtz resonance) show oscillation patterns. In the amplification factor plots, areas of high amplification are evident as darker shades of gray (Figure 23). Corresponding phase contours are shown in Figure 24. Areas in which phase contours are tightly bunched indicate nodal areas. As would be expected for standing waves, nodal lines in Figure 24 coincide with low amplification factors in Figure 23. The phase plots also indicate areas of the harbor which rise and fall together during the resonant condition (same gray shade). Thus the oscillation patterns can be interpreted.

The 150.60-sec resonant period shown in Figure 23 represents a relatively simple rocking oscillation between the outer and inner harbor areas. The nodal line lies just inside of the entrance to the inner harbor. In the 61.35-sec period resonance, opposite corners of the harbor complex act in phase. The main entrance and northeast corner rise and fall together, as do the north part of the outer harbor and the southeast corner of the inner harbor. A nodal line intersects the wharf. Shorter period resonances occur across shorter harbor dimensions or as higher order modes along the longer dimensions. The 40.16-sec resonance

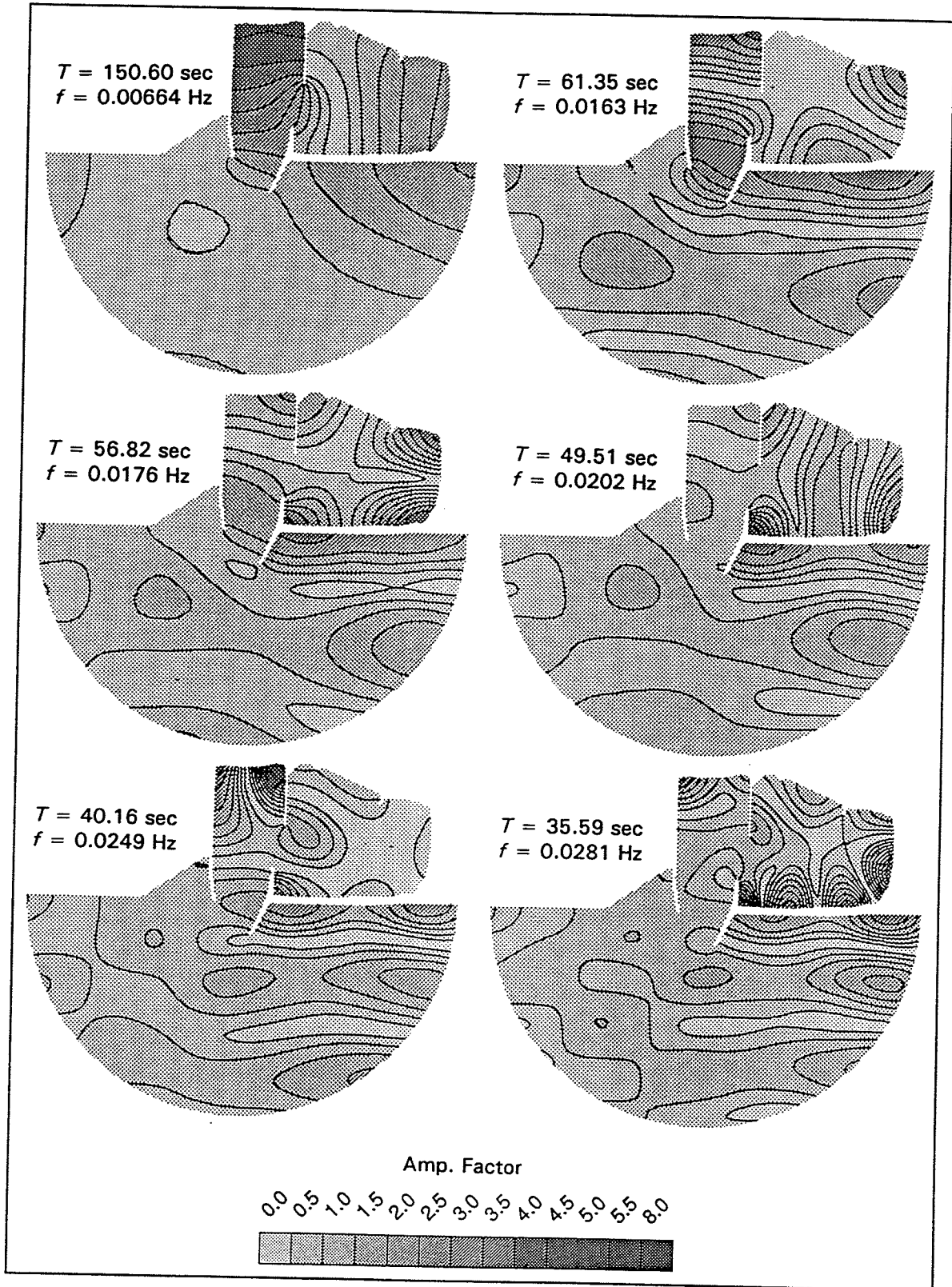

Figure 23. Resonant long wave amplification factor contours, existing harbor

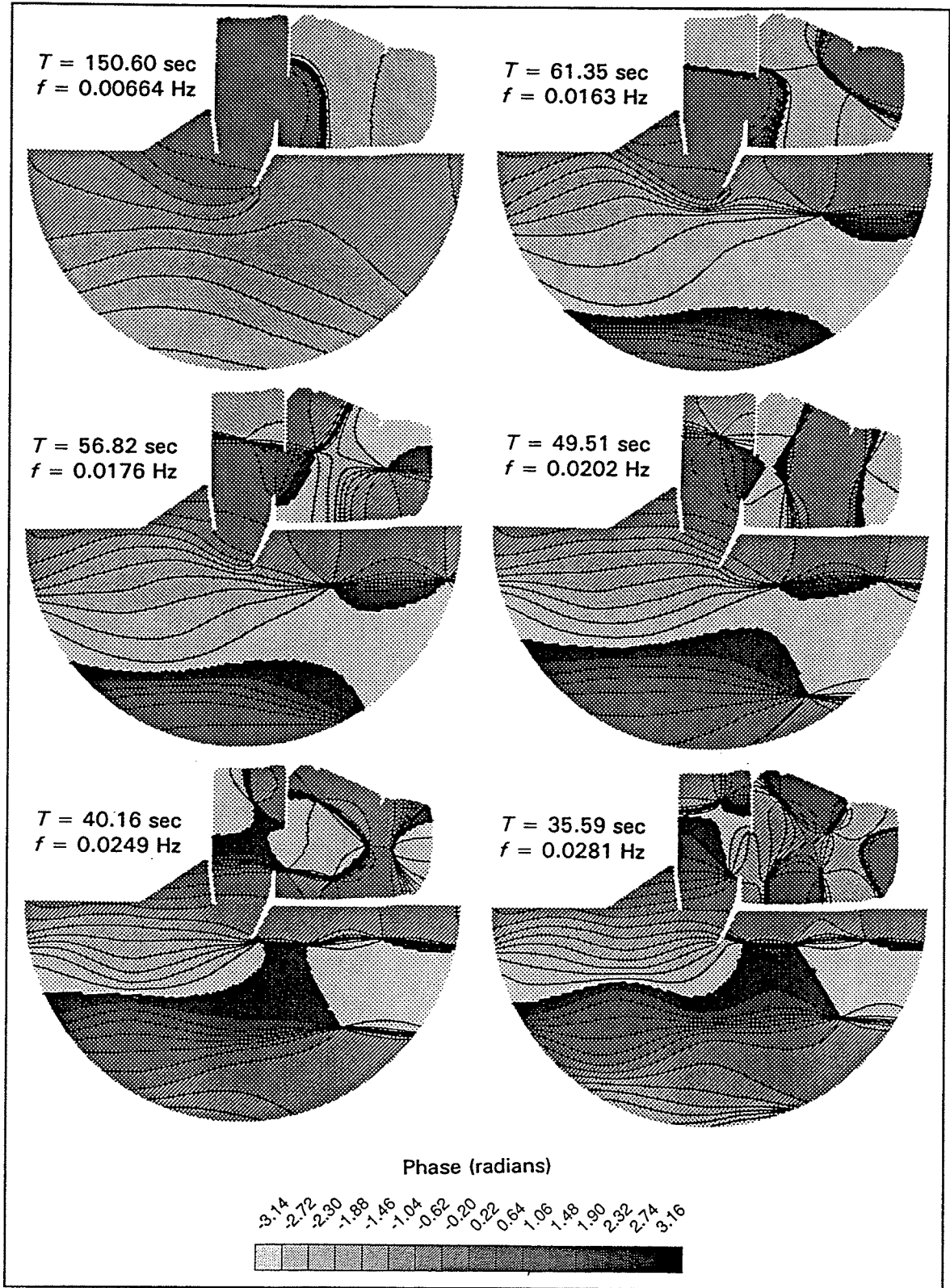

Figure 24. Resonant long wave phase contours, existing harbor

between the west breakwater and the inner east breakwater stub is of special note because it generated the highest amplification factors.

Long wave amplification factors shown here may be overestimated for resonant peaks at periods less than about 100 sec. Wave reflection coefficient at all solid boundaries was set to 1.0 for all long wave runs, but the recent Kahului Harbor study and physical reasoning indicate that small reductions in reflection coefficient at the shorter long wave periods may be appropriate.

Amplification factor and phase contour plots for the main resonant frequencies in Plan 6 are given in Figures 25 and 26. The longest period resonance, with a period of 113.64 sec, is a simple rocking motion between the inner and outer harbors. The period of this resonance is shorter than the similar resonance in the existing harbor, mainly due to the greater water depths in Plan 6. The 73.53-sec resonance is a rocking motion between the east and west areas of the inner harbor. The north area of the outer harbor also participates in phase with the east inner harbor. The 57.47-sec motion is a simple rocking between the north and south areas of the harbor complex. As with the existing harbor, a strong resonance occurs between the west breakwater and the inner east breakwater stub. The period of this resonance, 39.68 sec, is nearly the same as in the existing harbor.

## Evaluation Against Operational Criteria for Long Waves

Procedures for evaluating the operational acceptability of different harbor plans subjected to long waves are reviewed by Thompson et al. (1996) in relation to the deep draft Kahului Harbor. Long wave heights (which are unavailable at Kikiaola Harbor since no wave gage data were collected) are a key factor in most of the procedures, but some operational evaluation can be based on amplification factors.

An operational guideline is based on the value of  $A_{amp,l}$  for the higher resonant peaks. Experience with Los Angeles and Long Beach harbors has indicated that if  $A_{amp,l}$  is greater than about 5, some operational difficulties may be encountered. If  $A_{amp,l}$  is greater than 10, major operational problems can be expected.<sup>1</sup> This guideline may be applied to the plots in Appendix C. The only output basins signaling potential operational problems are located in the corner just west of the inner east stub breakwater (Basin 21 in the existing harbor; Basin 24 in Plan 6). Values of  $A_{amp,l}$  at this location are approximately 7 in the existing harbor and 5 in Plan 6. Since this area is not planned for operational use, the existing and Plan 6 harbors do not appear to suffer from detrimental harbor oscillations.

---

<sup>1</sup> Personal Communication, William C. Seabergh, Research Hydraulic Engineer, U.S. Army Engineer Waterways Experiment Station, Vicksburg, MS.

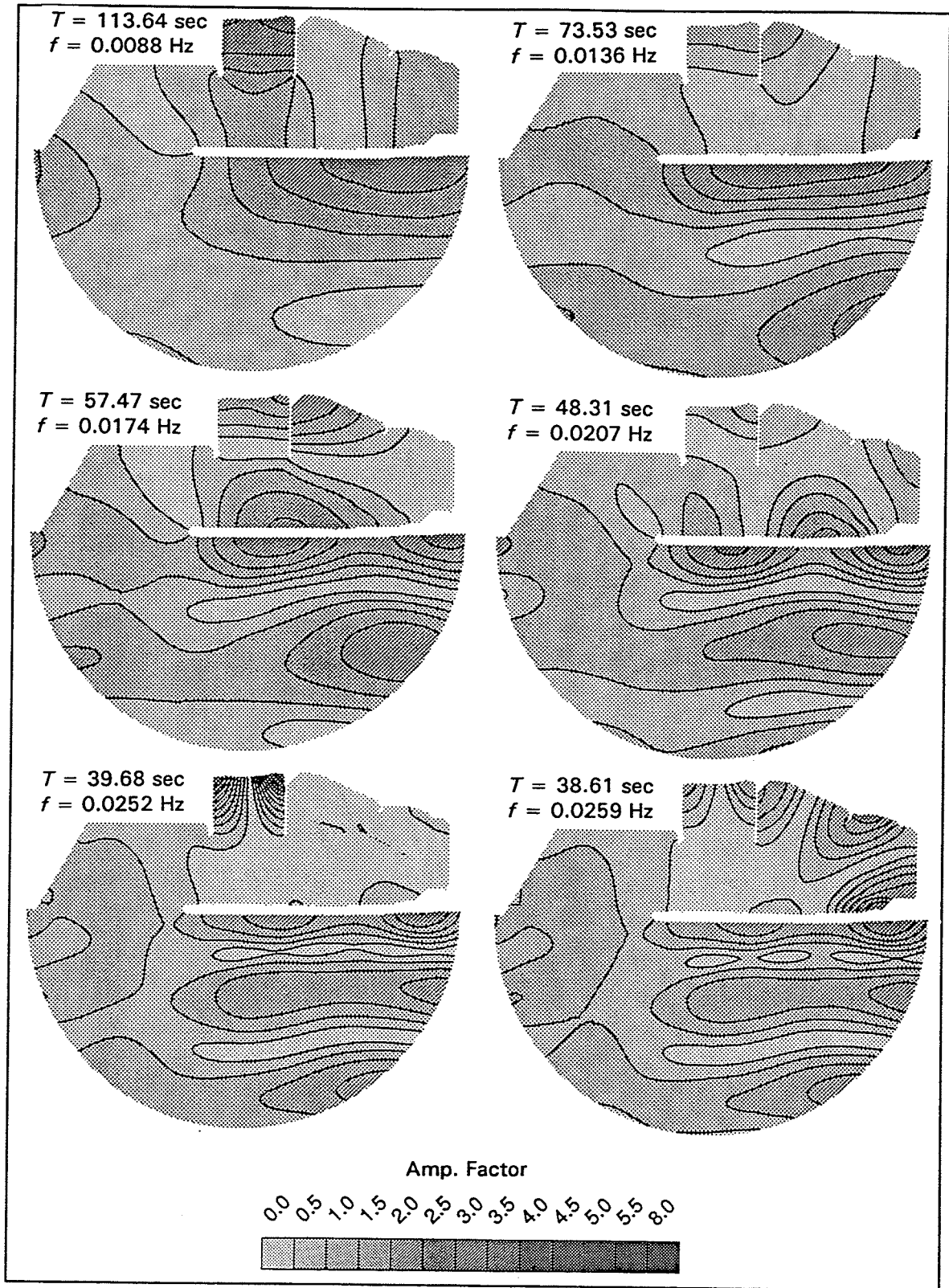

Figure 25. Resonant long wave amplification factor contours, Plan 6



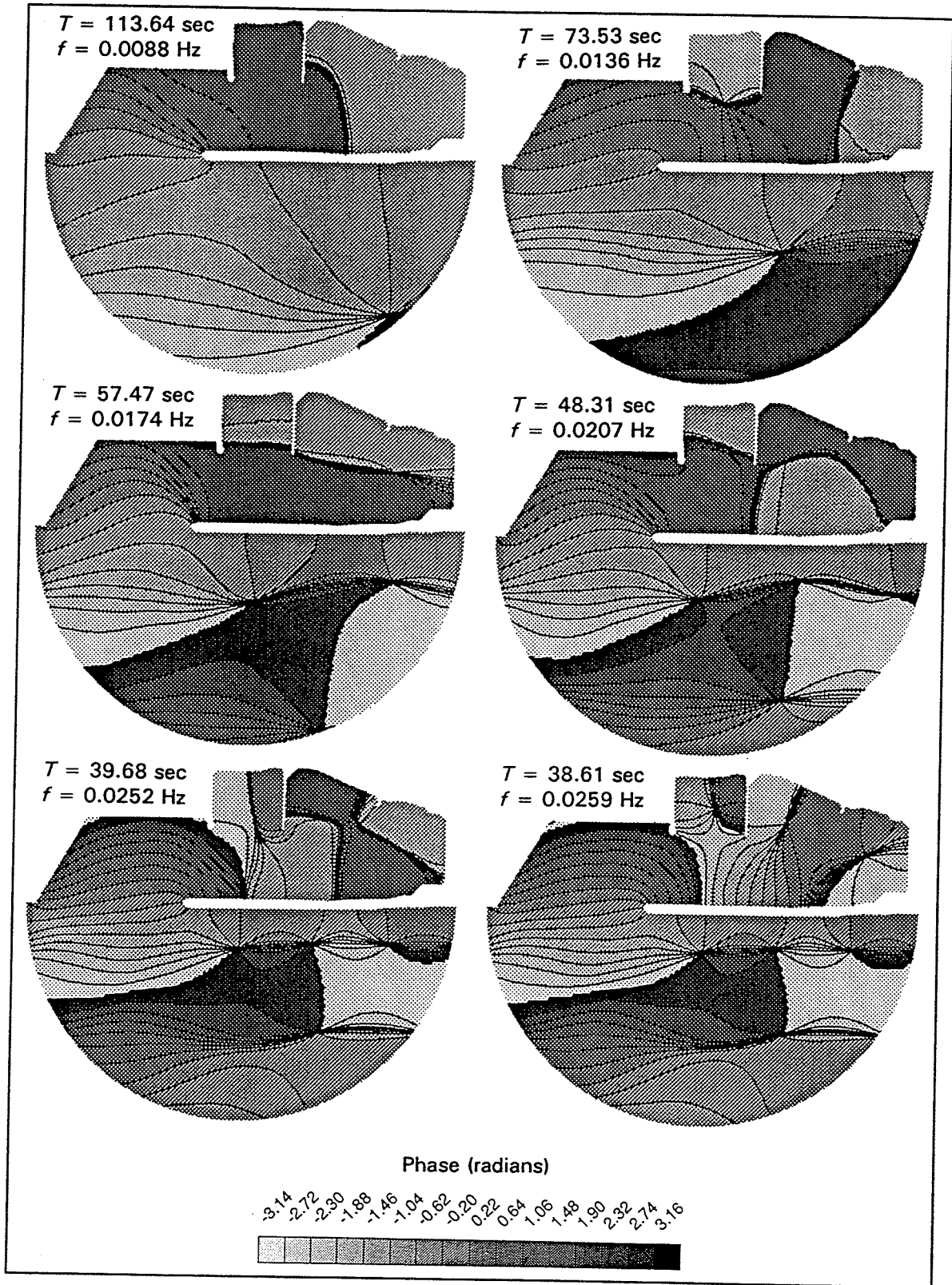

Figure 26. Resonant long wave phase contours, Plan 6

Plan 6 shows a small improvement in harbor oscillation performance over the existing harbor. The differences are most notable as reduced amplification factor peaks in harbor and outer basin corners (Appendix C).



## 6 Conclusions and Recommendations

---

Numerical model studies of the wave response of Kikiaola Harbor have produced valuable information about the existing harbor and possible modifications. The numerical model was used to simulate the behavior of the existing harbor and two alternative modifications to the harbor. Model results are compared with criteria for operational acceptability and with experience in the existing harbor to the extent possible. The effectiveness of proposed alternatives for wind wave and swell protection does not necessarily correlate with protection from oscillations. These two aspects of harbor operability are both considered in judging success of the alternative plans.

Performance of the alternative plans can be summarized by their success relative to simple, meaningful criteria. For wind waves and swell, success was defined as meeting or bettering the USACE criteria for harbor and entrance channel tranquillity (Chapter 4). A major reduction in the occurrence of wave breaking in the entrance channel is also desired. Plan performance relative to each of these wind wave and swell concerns is as follows:

*a. USACE criterion in berthing areas.* Plan 1, Plan 6, and the existing harbor all satisfied this criterion. Berthing areas are well protected from wind waves and swell in all plans.

*b. USACE criterion in entrance and access channels.* Plan 1 satisfied this criterion everywhere except at the seaward end of the entrance channel, where the 10 percent exceedance  $H_s$  is 2.2 ft (compared to 2.0 ft specified in the criterion). Plan 6 also satisfied the criterion everywhere except in the seaward part of the entrance channel. The existing, shoaled outer entrance channel significantly failed the USACE criterion. The inner portion of the existing channel, beginning at around the 90-deg turn, satisfied the criterion.

For both Plan 1 and Plan 6, the outer entrance channel flares out to give extra width for vessel maneuvering. A small exceedance of the USACE criterion in the wider, more open channel may not be cause for concern.

Wave conditions in the landward portion of the Plan 6 entrance channel are a potential navigation concern. From where the channel passes just west of the

main breakwater up to the 90-deg turn into the lee of the breakwater, wave conditions approach (but do not exceed) the USACE criterion. The ability of vessels to navigate safely past the breakwater head and turn into protected waters should be given due consideration. Experience with the existing harbor, which also requires a 90-deg turn in an area where wave heights can be fairly high (Figure 21), should be helpful in assessing the navigation concerns.

*c. Breaking waves.* Breaking waves are a potential concern in the exposed entrance channel. The HARBD numerical model does not identify breaking wave conditions, but they can be inferred from wave heights and water depths. In the existing channel, the shoaled depths are less than 6 ft in some areas. The 10 percent exceedance  $H_s$  outside the breakwater entrance was estimated as 3.6 ft (Figure 21). When  $H_s$  exceeds about 0.5-0.6 times the depth, significant wave breaking can be expected. Thus the existing entrance channel would be expected to experience breaking wave conditions more than 10 percent of the time.

In Plan 1 and Plan 6, the channel depth is 12 ft and the 10 percent exceedance  $H_s$  is around 2 ft or less. Thus breaking wave conditions would not be expected in these plans.

There are several key limitations on the above conclusions. First, the coast around Kikiaola Harbor is an area of active sediment movement. The existing channel and harbor have experienced shoaling problems. The present study was based on actual depths of the existing harbor but project depths of Plan 1 and Plan 6. If either plan were constructed and significant shoaling occurred, the wind wave and swell response would change from the estimates of this study. Also, wave breaking could again become a problem. Sediment transport and channel shoaling were outside the scope of this study, but they are important considerations in selecting a final plan for the harbor.

Another limitation is the wave climate information. It was derived from one year of hindcasts in a rather difficult area. Conclusions based on wave climate would have had a higher confidence level if high-quality local measurements were available. Limitations associated with the numerical harbor model were presented in Chapter 1. The absence of wave breaking and currents are the most relevant limitations in the present study.

Harbor response to long waves (harbor oscillations) was analyzed for the existing harbor and Plan 6. Plan 1 was not included in this part of the study. Based on experience in other harbors correlating long wave amplification factors with operational problems, the existing harbor and Plan 6 both appear to be free of oscillation problems. The only harbor area of potential concern is between the west breakwater and the inner east breakwater stub, which is not planned as a mooring facility. Oscillations in Plan 6 are less than in the existing harbor.

A physical model study to optimize the preferred plan may be cost effective as a final phase of the studies. A focused physical model study is likely to result in cost savings beyond the study cost in fine-tuning design details such as breakwater

length, crest height, and slope. Also, the physical model can reproduce some processes not represented in the numerical model, such as wave breaking.

# References

---

- Brooks, R. M., and Brandon, W. A. 1995. "Hindcast Wave Information for the U.S. Atlantic Coast: Update 1976-1993 with Hurricanes," WIS Report 33, US Army Engineer Waterways Experiment Station, Vicksburg, Miss.
- Chen, H. S. 1986. "Effects of Bottom Friction and Boundary Absorption on Water Wave Scattering," *Applied Ocean Research*, Vol 8, No 2, pp 99-104.
- Chen, H. S., and Houston, J. R. 1987. "Calculation of Water Oscillation in Coastal Harbors: HARBS and HARBD User's Manual," Instruction Report CERC-87-2, US Army Engineer Waterways Experiment Station, Vicksburg, Miss.
- Corson, W. D., Abel, C.E., Brooks, R.M., Farrar, P.D., Groves, B.J., Jensen, R.E., Payne, J.B., Ragsdale, D.S., and Tracy, B.A. 1986. "Pacific Coast Hindcast Deepwater Wave Information," WIS Report 14, US Army Engineer Waterways Experiment Station, Vicksburg, Miss.
- Leenknecht, D. A., and Tanner, W. W. 1996. "Scientific Visualization Techniques for Wave Transformation Models," *Proceedings, 3rd Congress on Computing in Civil Engineering*, ASCE, Anaheim, CA, 704-710.
- Leenknecht, D. A., Tanner, W. W., and Sherlock, A. R. 1997. "Grid Generation & Data Analysis for Wave Transformation Models," *Proceedings, 4th Congress on Computing in Civil Engineering*, ASCE, Philadelphia, PA.
- Lillycrop, L. S., and Thompson, E. F. 1996. "Harbor Wave Oscillation Model (HARBD) Theory and Program Documentation." In "Coastal Modeling System (CMS) User's Manual," Instruction Report CERC-91-1, M.A. Cialone, ed., US Army Engineer Waterways Experiment Station, Vicksburg, Miss.
- Thompson, E. F., and Hadley, L. L. 1995. "Numerical Modeling of Harbor Response To Waves," *J. Coastal Research*, 11(3), 744-753.

- Thompson, E. F., and Harris, D. L. 1972. "A Wave Climatology for U.S. Coastal Waters," *Proceedings, Offshore Technology Conference*, Houston, TX, 675-688.
- Thompson, E. F., Hadley, L. L., Brandon, W. A., McGehee, D. D., and Hubertz, J. M. 1996. "Wave Response of Kahului Harbor, Maui, Hawaii," Technical Report CERC-96-11, US Army Engineer Waterways Experiment Station, Vicksburg, Miss.
- Turner, P. J., and Baptista, A. M. 1993. "ACE/gredit User's Manual," Center for Coastal and Land-Margin Research, Oregon Graduate Institute of Science and Technology, Beaverton, OR.
- U.S. Army Engineer Division, Pacific Ocean. 1980. "General Design Memorandum and Final Environmental Impact Statement for Navigation Improvements for Kikiaola Light-Draft Harbor, Waimea, Kauai, Hawaii," Honolulu, Hawaii.



# Appendix A

## Bathymetry and Output Basin Locations

---

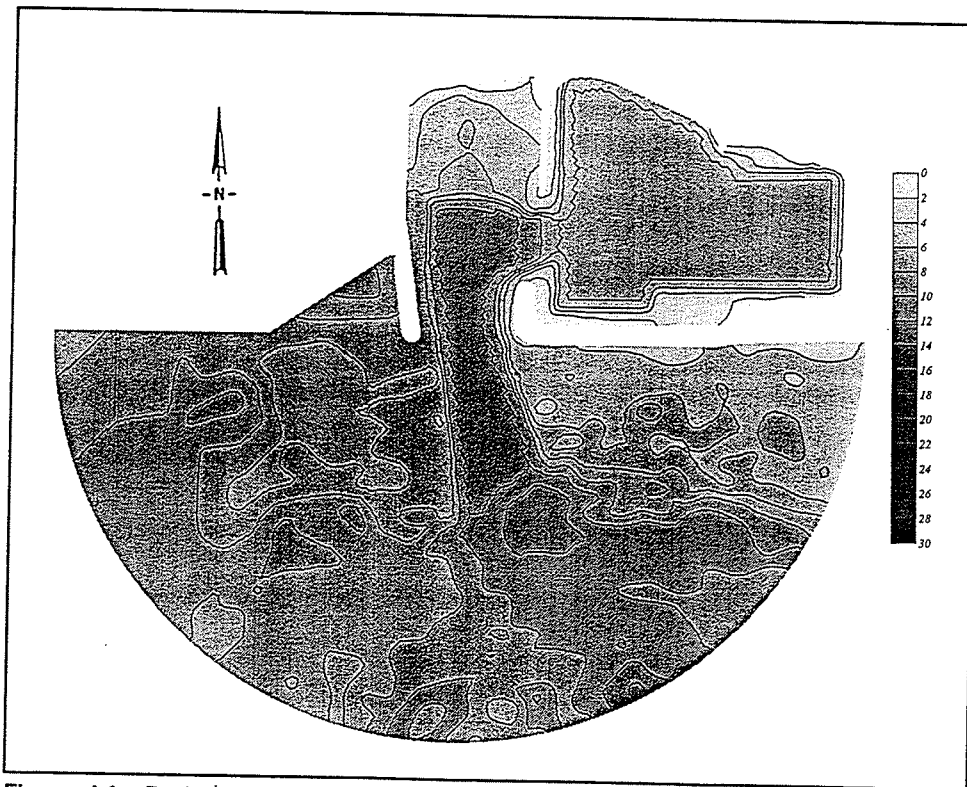

Figure A1. Bathymetry, Plan 1

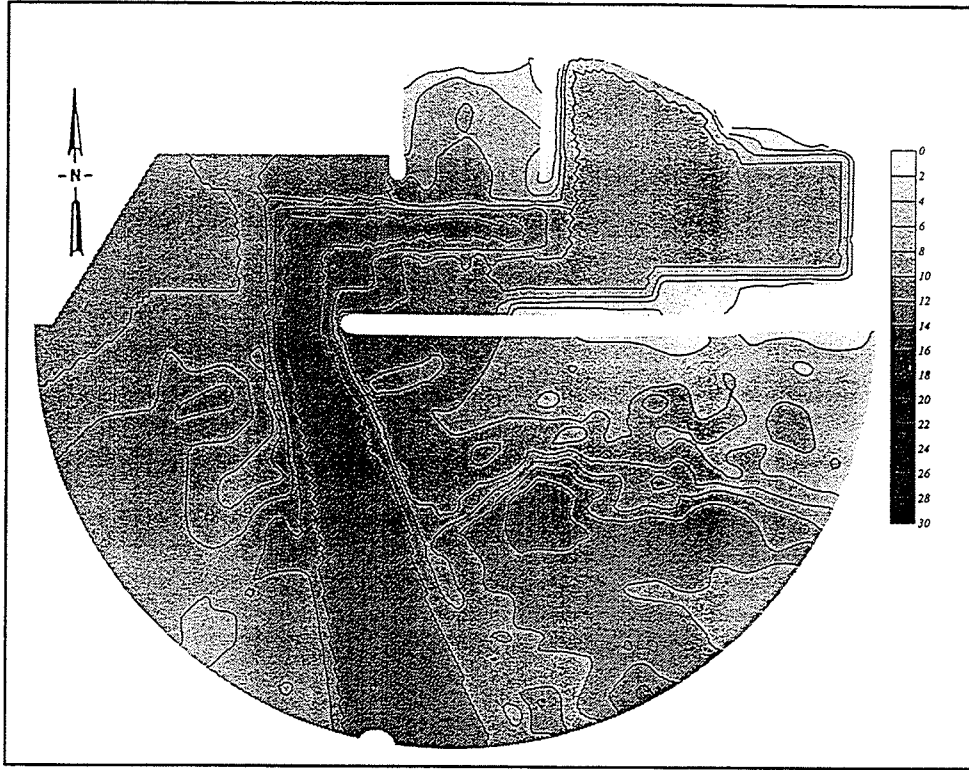

Figure A2. Bathymetry, Plan 6

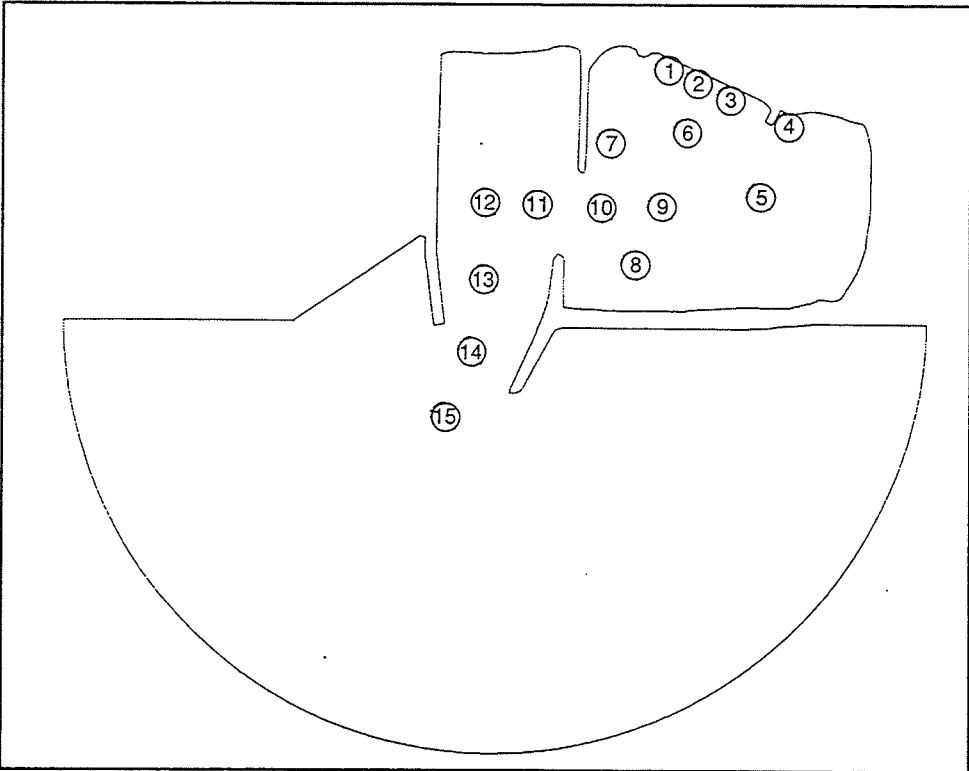

Figure A3. Basin locations, wind waves and swell, existing harbor



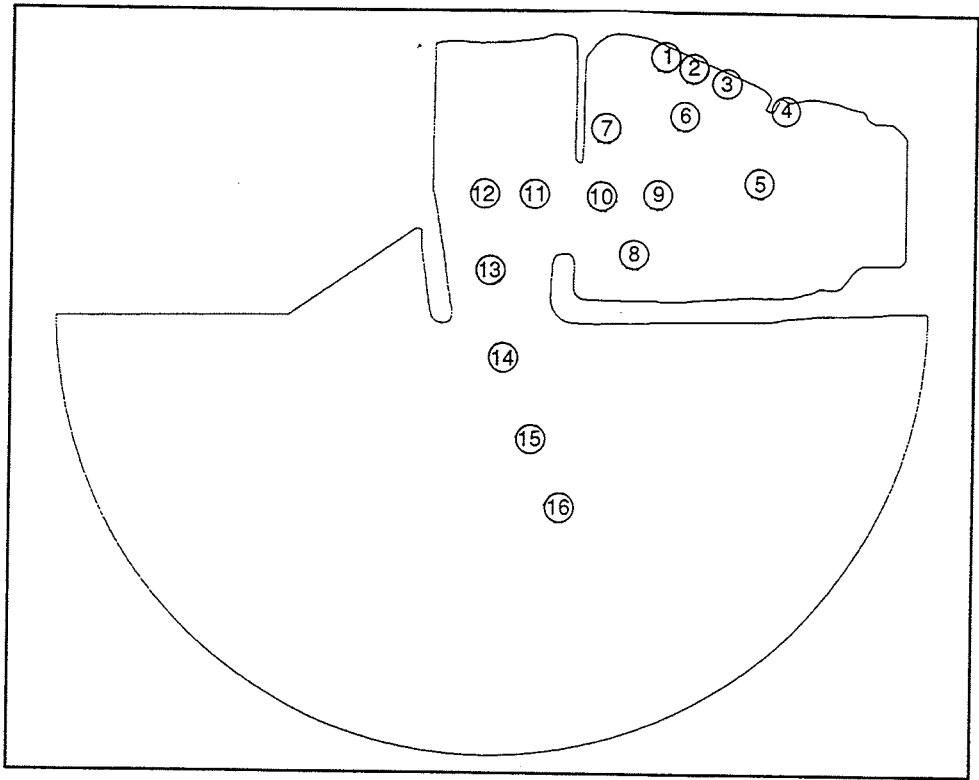

Figure A4. Basin locations, wind waves and swell, Plan 1

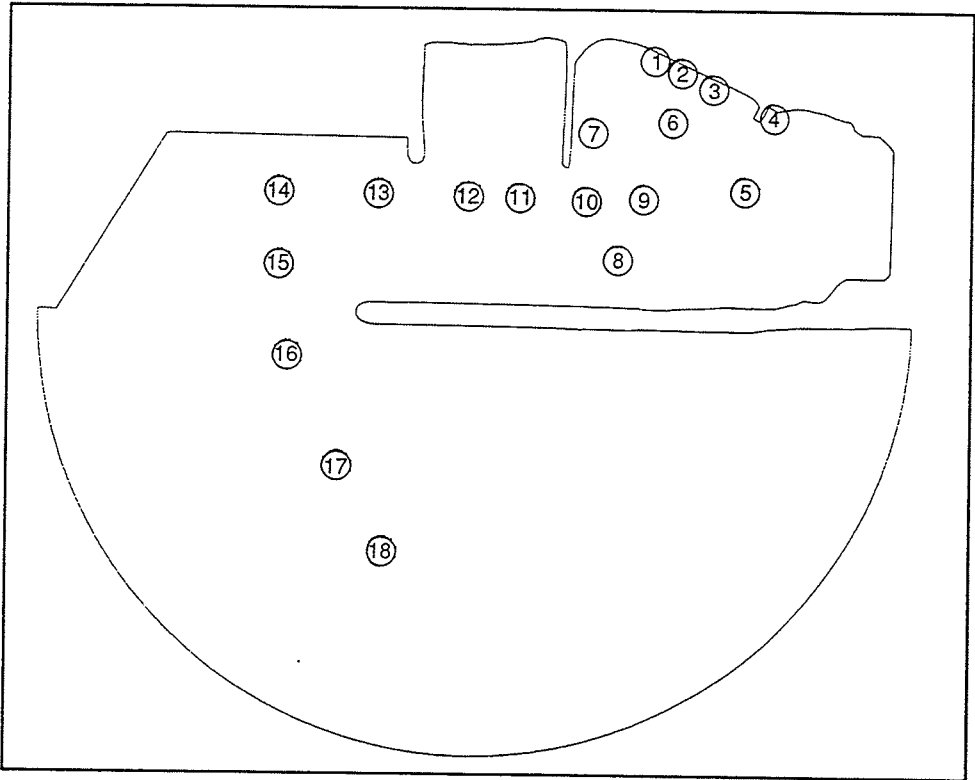

Figure A5. Basin locations, wind waves and swell, Plan 6

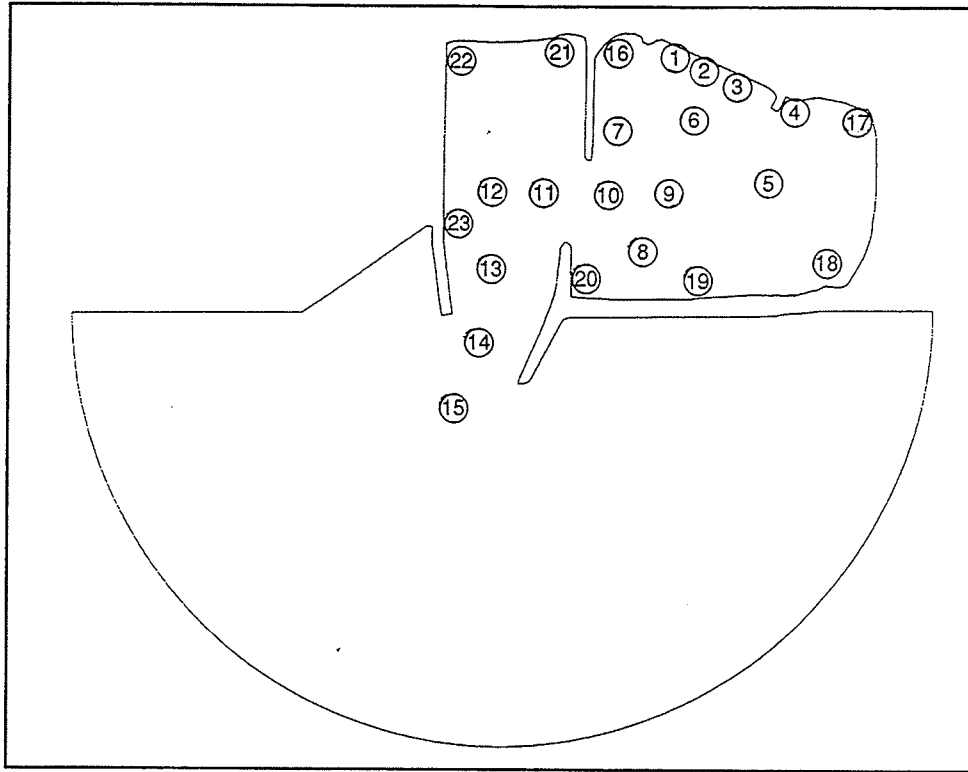

Figure A6. Basin locations, harbor oscillations, existing harbor

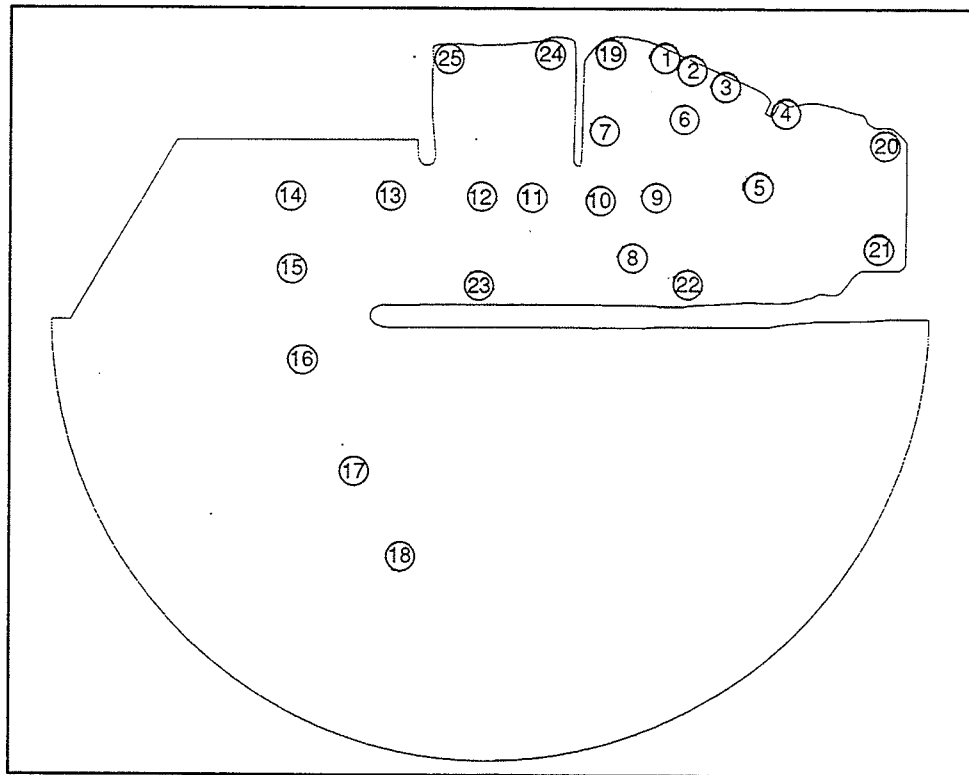

Figure A7. Basin locations, harbor oscillations, Plan 6

# **Appendix B**

## **Wind Wave and Swell**

### **Summaries from Numerical**

### **Model**

---

Table B1 $(A_{amp})_{eff}$ Values Averaged Over Wave Period, Existing Harbor							
Basin	Wave Direction (deg. azimuth, coming from)						
	150	160	170	180	190	200	210
1	0.06	0.08	0.10	0.12	0.15	0.17	0.19
2	0.07	0.09	0.12	0.15	0.18	0.21	0.23
3	0.07	0.10	0.12	0.16	0.19	0.22	0.24
4	0.05	0.06	0.08	0.10	0.12	0.14	0.15
5	0.06	0.07	0.09	0.12	0.14	0.16	0.18
6	0.09	0.11	0.15	0.19	0.23	0.27	0.29
7	0.12	0.15	0.19	0.25	0.30	0.35	0.39
8	0.05	0.06	0.08	0.10	0.13	0.15	0.17
9	0.09	0.11	0.14	0.18	0.21	0.24	0.26
10	0.11	0.15	0.19	0.24	0.29	0.34	0.37
11	0.24	0.30	0.38	0.48	0.59	0.69	0.75
12	0.29	0.35	0.41	0.50	0.59	0.67	0.73
13	0.38	0.47	0.57	0.70	0.84	0.96	1.05
14	0.63	0.71	0.81	0.94	1.09	1.22	1.31
15	1.12	1.15	1.19	1.26	1.32	1.39	1.43

Table B2 ( $A_{amp}$ ) <sub>eff</sub> Values Averaged Over Wave Period, Plan 1							
Basin	Wave Direction (deg. azimuth, coming from)						
	150	160	170	180	190	200	210
1	0.05	0.05	0.06	0.07	0.08	0.09	0.10
2	0.05	0.06	0.06	0.07	0.08	0.10	0.10
3	0.06	0.06	0.07	0.08	0.10	0.11	0.12
4	0.04	0.05	0.05	0.06	0.08	0.09	0.09
5	0.05	0.05	0.06	0.07	0.08	0.09	0.10
6	0.06	0.07	0.08	0.09	0.10	0.12	0.13
7	0.08	0.08	0.09	0.11	0.13	0.14	0.15
8	0.06	0.06	0.07	0.07	0.08	0.09	0.09
9	0.08	0.08	0.09	0.10	0.12	0.13	0.14
10	0.11	0.12	0.13	0.15	0.17	0.19	0.21
11	0.16	0.17	0.18	0.21	0.24	0.27	0.28
12	0.18	0.19	0.22	0.26	0.31	0.37	0.40
13	0.29	0.31	0.34	0.40	0.47	0.54	0.59
14	0.45	0.46	0.46	0.48	0.50	0.53	0.55
15	0.64	0.65	0.65	0.65	0.64	0.63	0.62
16	0.77	0.78	0.78	0.78	0.76	0.74	0.71

<b>Table B3</b>							
<b><math>(A_{amp})_{eff}</math> Values Averaged Over Wave Period, Plan 6</b>							
<b>Basin</b>	<b>Wave Direction (deg. azimuth, coming from)</b>						
	<b>150</b>	<b>160</b>	<b>170</b>	<b>180</b>	<b>190</b>	<b>200</b>	<b>210</b>
<b>1</b>	0.03	0.03	0.03	0.03	0.04	0.05	0.05
<b>2</b>	0.04	0.04	0.04	0.04	0.05	0.05	0.06
<b>3</b>	0.04	0.04	0.04	0.05	0.05	0.06	0.07
<b>4</b>	0.04	0.04	0.04	0.04	0.05	0.05	0.06
<b>5</b>	0.05	0.05	0.05	0.06	0.06	0.07	0.08
<b>6</b>	0.05	0.05	0.05	0.05	0.06	0.07	0.08
<b>7</b>	0.05	0.06	0.06	0.06	0.07	0.08	0.08
<b>8</b>	0.09	0.09	0.09	0.10	0.10	0.11	0.12
<b>9</b>	0.06	0.06	0.06	0.07	0.08	0.09	0.10
<b>10</b>	0.08	0.08	0.08	0.09	0.10	0.11	0.12
<b>11</b>	0.10	0.10	0.10	0.11	0.12	0.13	0.14
<b>12</b>	0.13	0.13	0.14	0.15	0.17	0.19	0.20
<b>13</b>	0.23	0.25	0.27	0.30	0.35	0.39	0.41
<b>14</b>	0.44	0.48	0.54	0.63	0.76	0.89	0.97
<b>15</b>	0.44	0.48	0.54	0.63	0.76	0.89	0.97
<b>16</b>	0.52	0.52	0.53	0.57	0.64	0.72	0.77
<b>17</b>	0.71	0.71	0.72	0.73	0.76	0.80	0.83
<b>18</b>	0.83	0.82	0.81	0.80	0.81	0.84	0.86

**Table B4**  
**( $A_{amp,eff}$ ) Values Weighted by**  
**Wind Wave and Swell Climate**

Basin	Plan		
	Existing	1	6
1	0.15	0.07	0.03
2	0.19	0.08	0.04
3	0.20	0.09	0.05
4	0.12	0.07	0.04
5	0.13	0.07	0.06
6	0.25	0.09	0.05
7	0.32	0.12	0.06
8	0.14	0.09	0.09
9	0.20	0.11	0.08
10	0.31	0.16	0.09
11	0.61	0.23	0.11
12	0.57	0.31	0.15
13	0.88	0.47	0.34
14	1.11	0.50	0.76
15	1.35	0.63	0.76
16		0.76	0.66
17			0.79
18			0.81

**Table B5**  
 **$H_s$  Values Exceeded 10 Percent and 1 Percent of the Time**

Basin Number	$H_s$ Values Exceeded 10% and 1% of Time (ft)					
	Existing		Plan 1		Plan 6	
	10%	1%	10%	1%	10%	1%
1	0.36	0.58	0.17	0.30	0.09	0.16
2	0.46	0.70	0.22	0.36	0.12	0.19
3	0.49	0.74	0.24	0.43	0.14	0.23
4	0.30	0.46	0.20	0.37	0.13	0.20
5	0.33	0.55	0.20	0.35	0.17	0.25
6	0.60	0.91	0.23	0.41	0.14	0.23
7	0.80	1.18	0.33	0.55	0.17	0.28
8	0.36	0.58	0.24	0.37	0.25	0.37
9	0.49	0.78	0.29	0.48	0.20	0.32
10	0.76	1.14	0.42	0.70	0.23	0.37
11	1.53	2.31	0.60	0.96	0.30	0.46
12	1.44	2.22	0.78	1.24	0.40	0.62
13	2.21	3.30	1.20	1.82	0.90	1.42
14	2.86	4.37	1.35	2.10	1.94	3.00
15	3.64	5.52	1.72	2.58	1.94	3.00
16			2.16	3.20	1.73	2.68
17					2.12	3.16
18					2.19	3.36



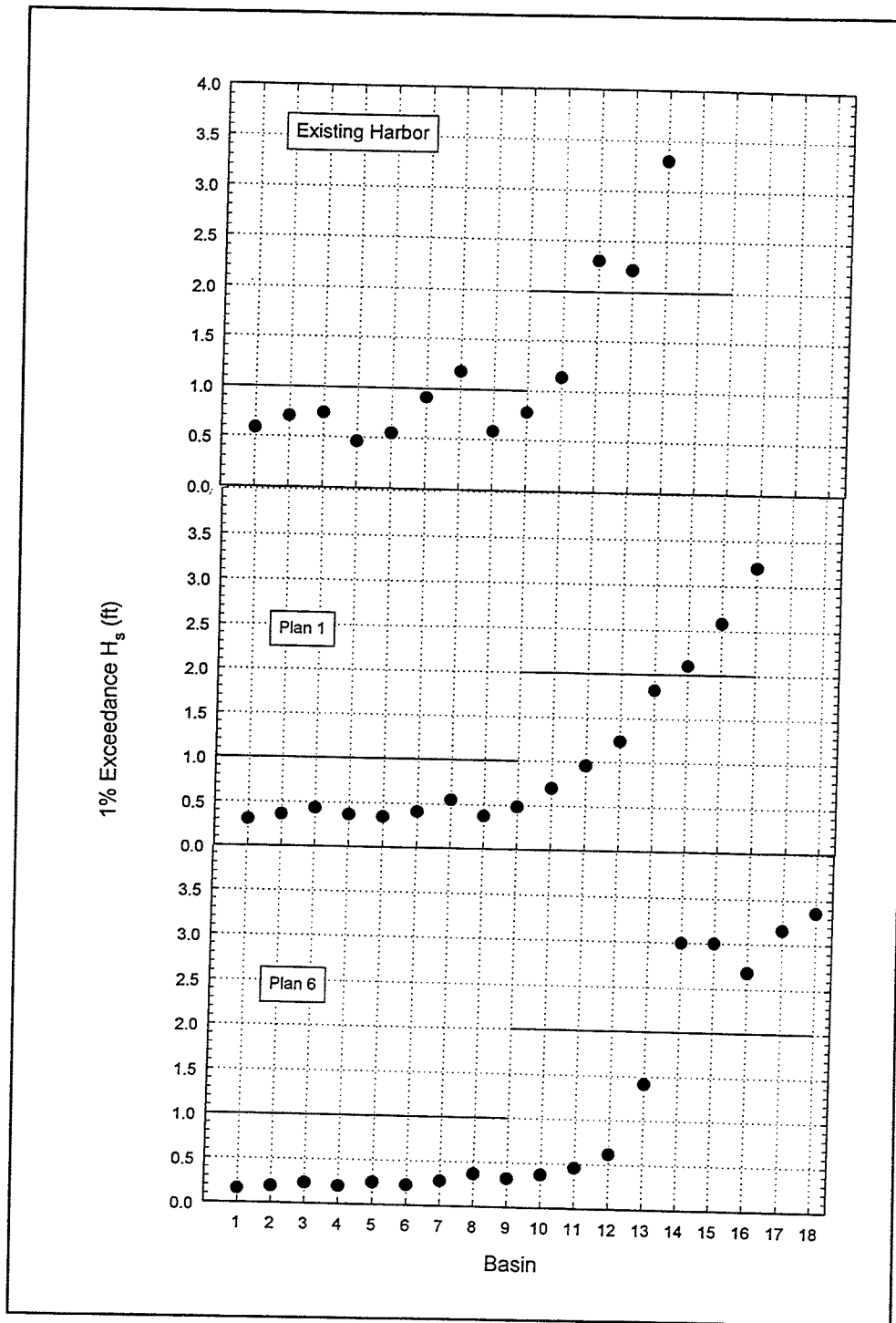
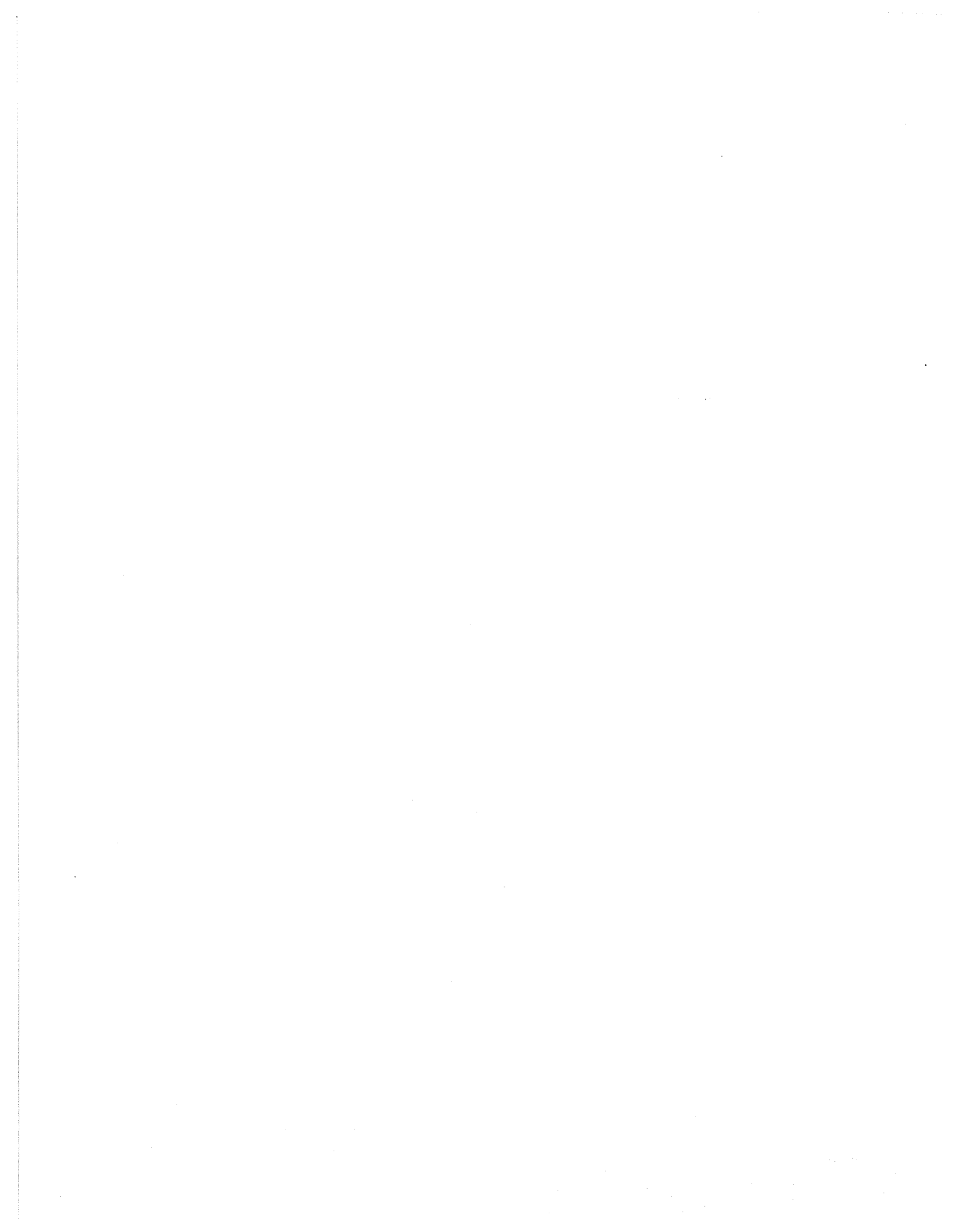

Figure B1. Comparison of  $H_s$  exceeded 1 percent of the time



# **Appendix C**

## **Harbor Oscillation Summaries**

### **from Numerical Model**

---

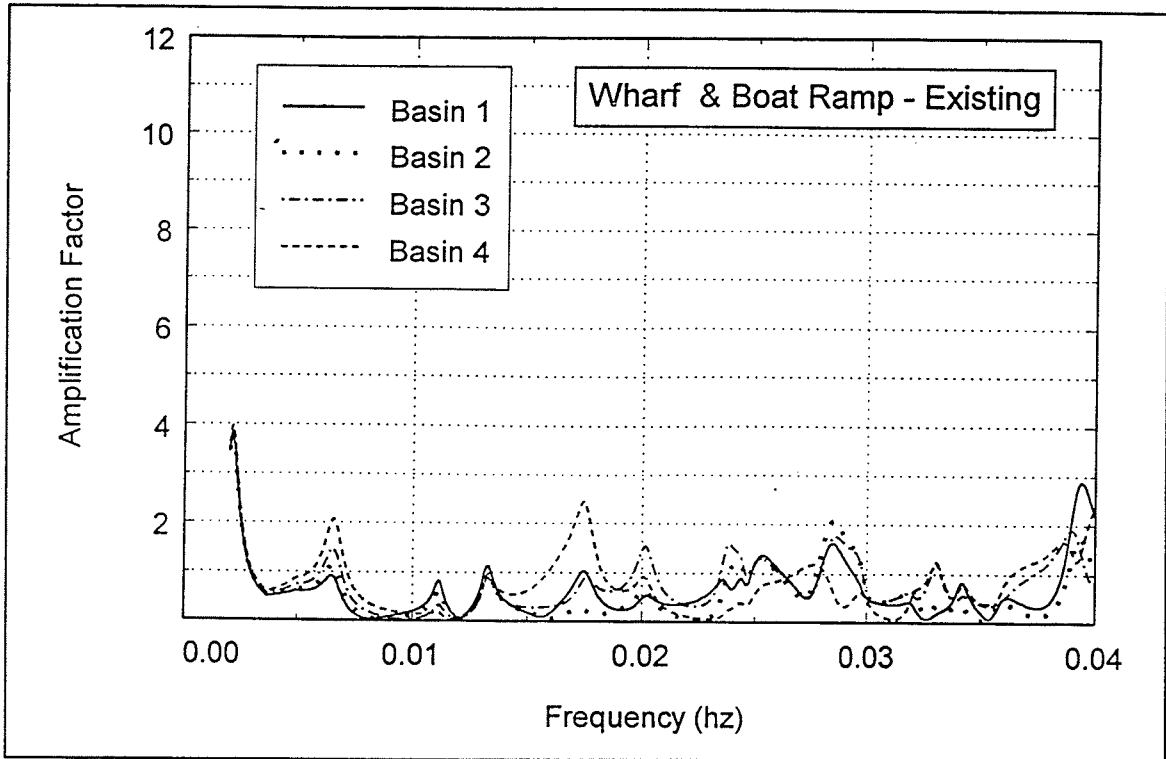

Figure C1. Long wave response, wharf and boat ramp, existing harbor

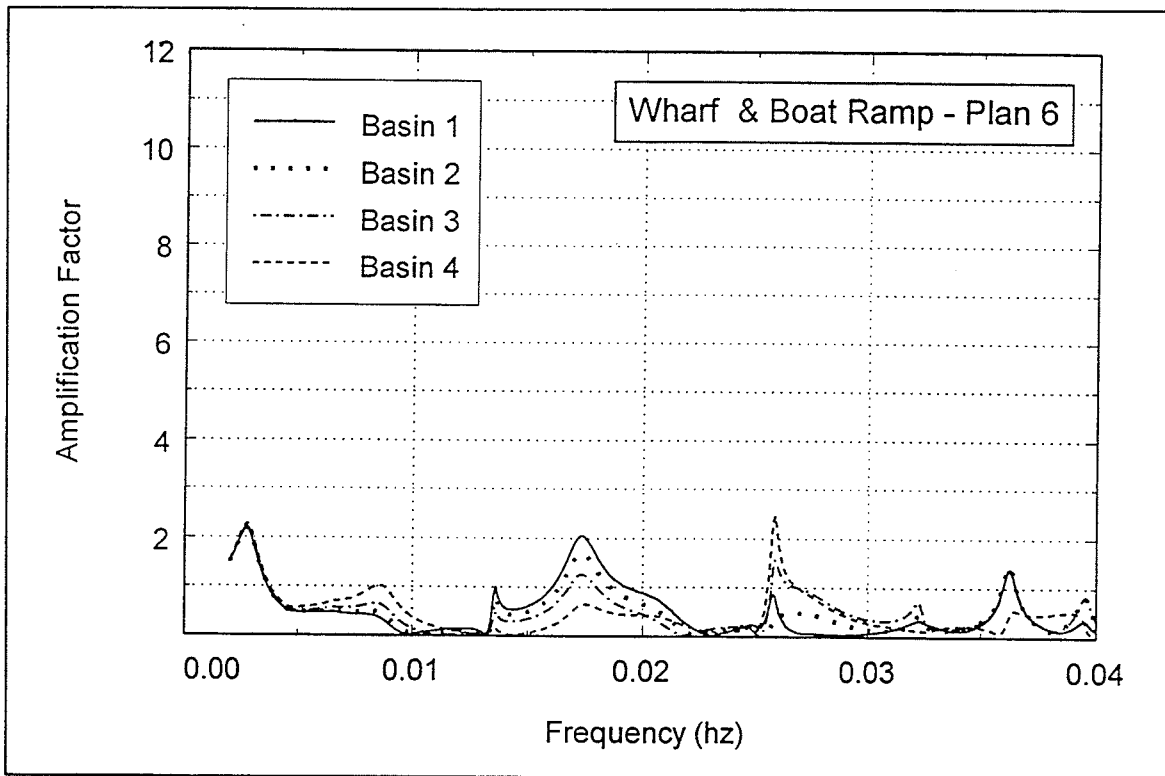

Figure C2. Long wave response, wharf and boat ramp, Plan 6

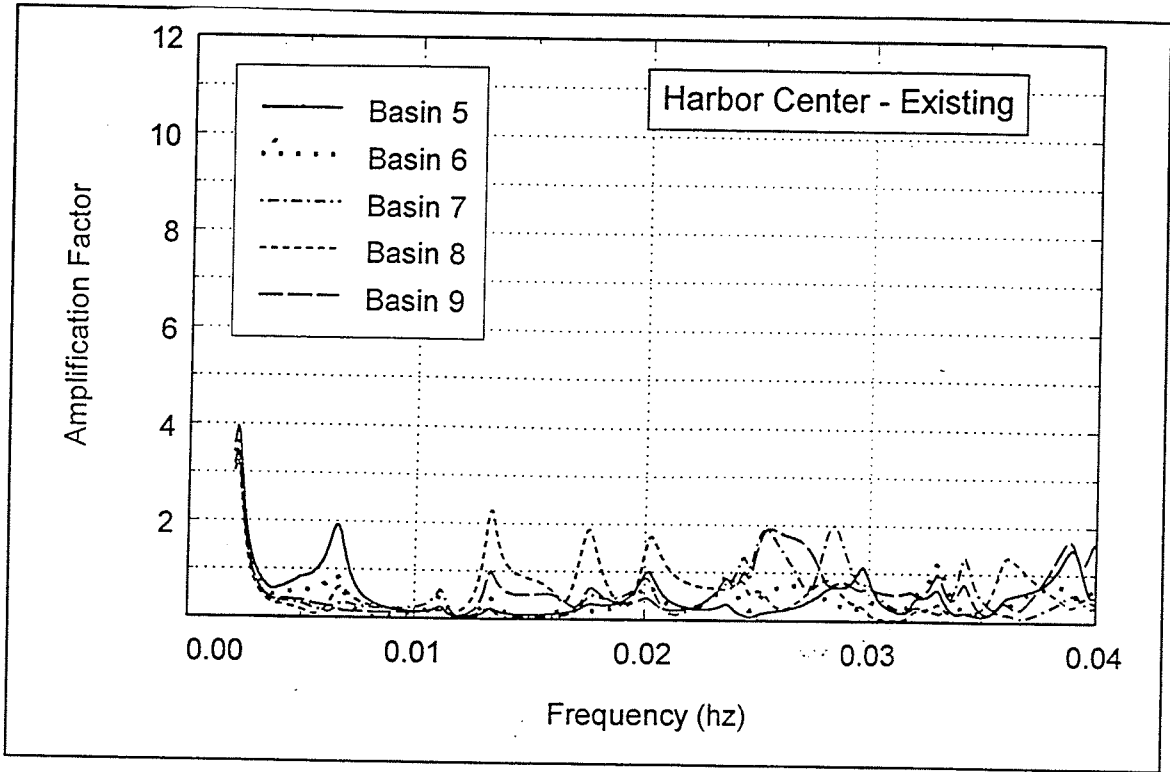

Figure C3. Long wave response, harbor center, existing harbor

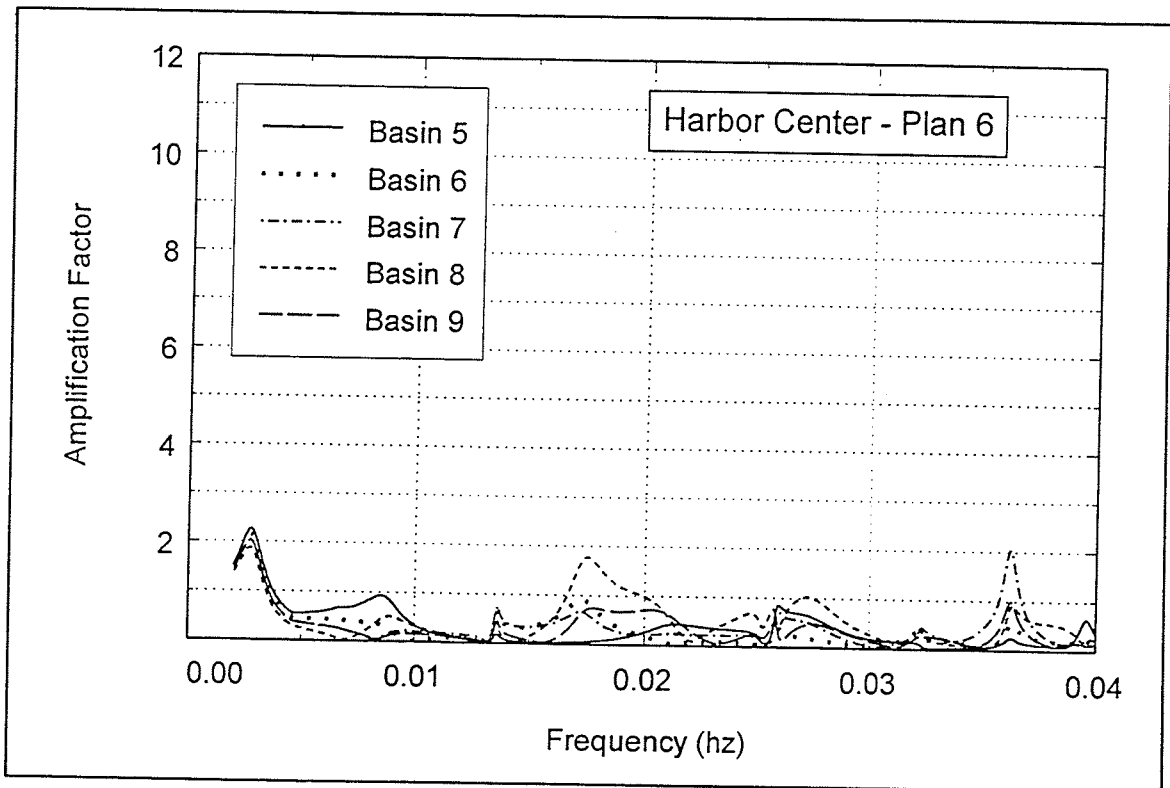

Figure C4. Long wave response, harbor center, Plan 6

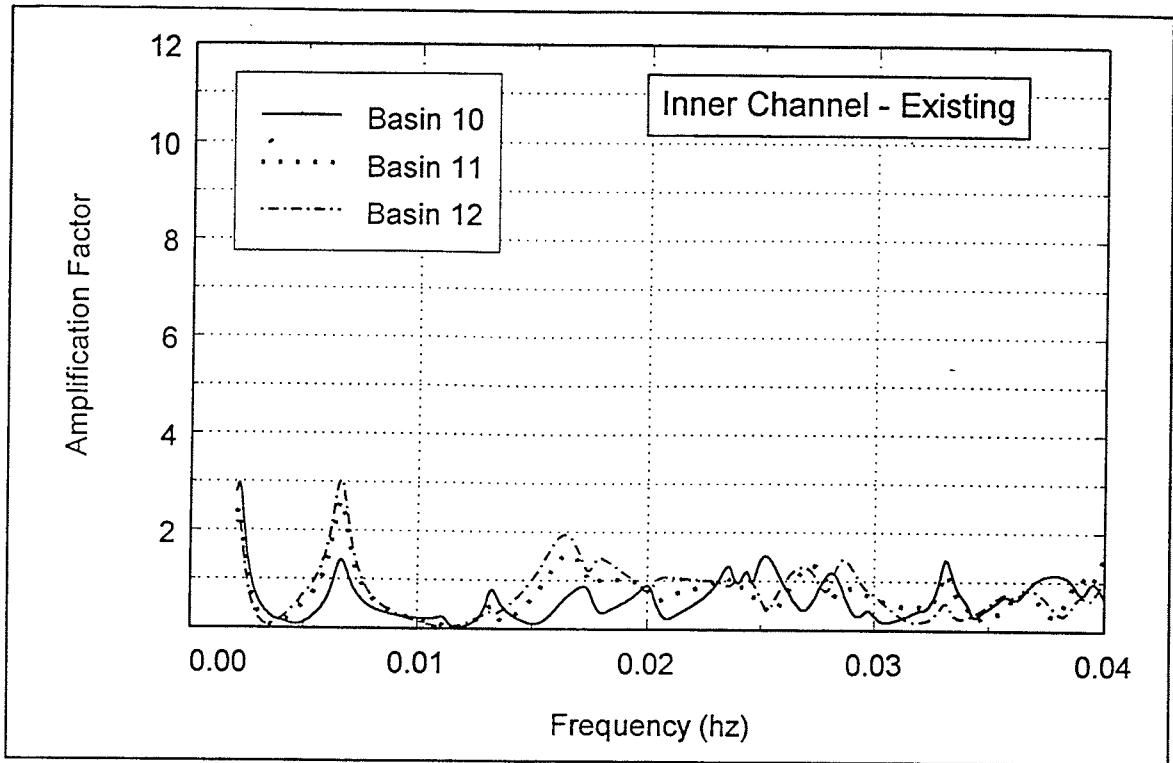

Figure C5. Long wave response, inner channel, existing harbor

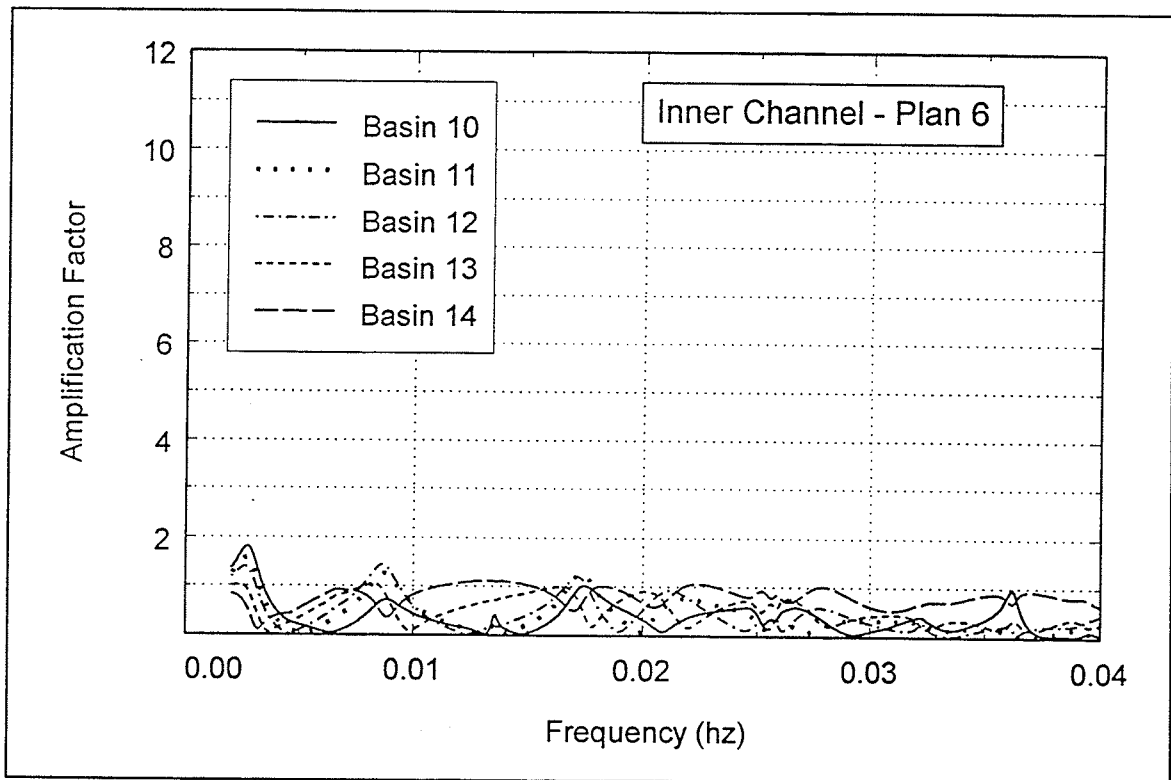

Figure C6. Long wave response, inner channel, Plan 6

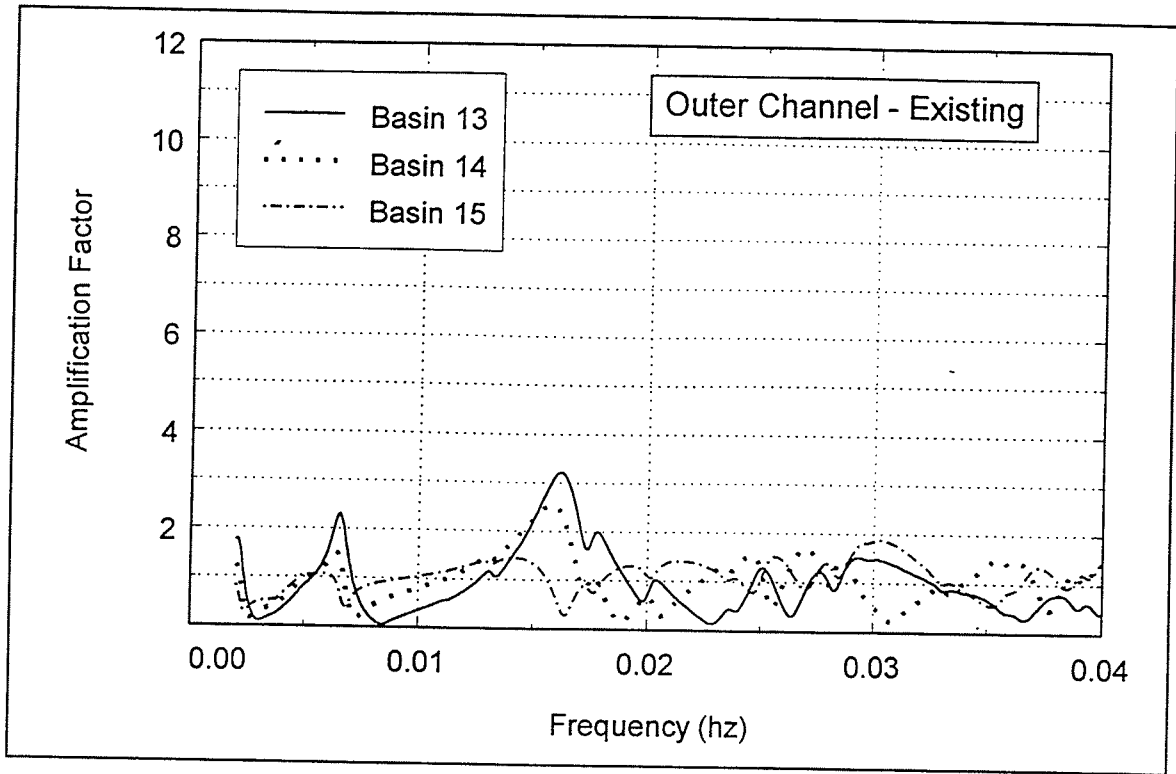

Figure C7. Long wave response, outer channel, existing harbor

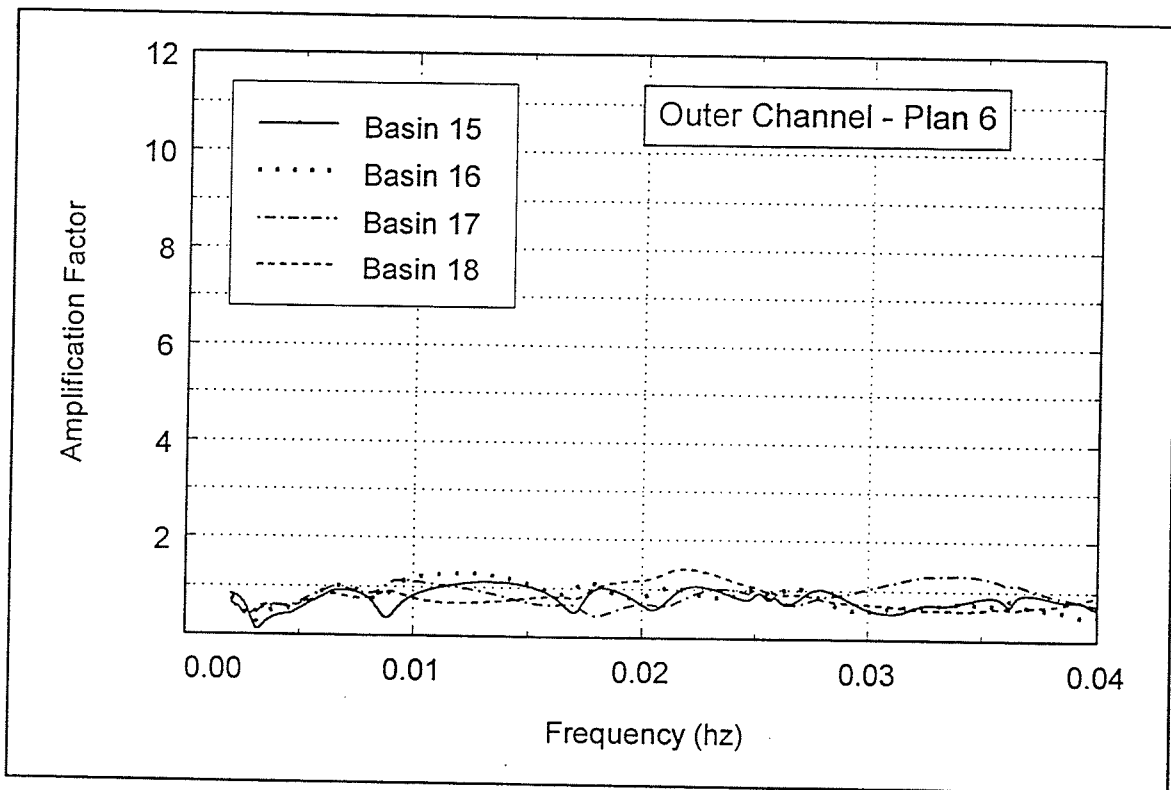

Figure C8. Long wave response, outer channel, Plan 6

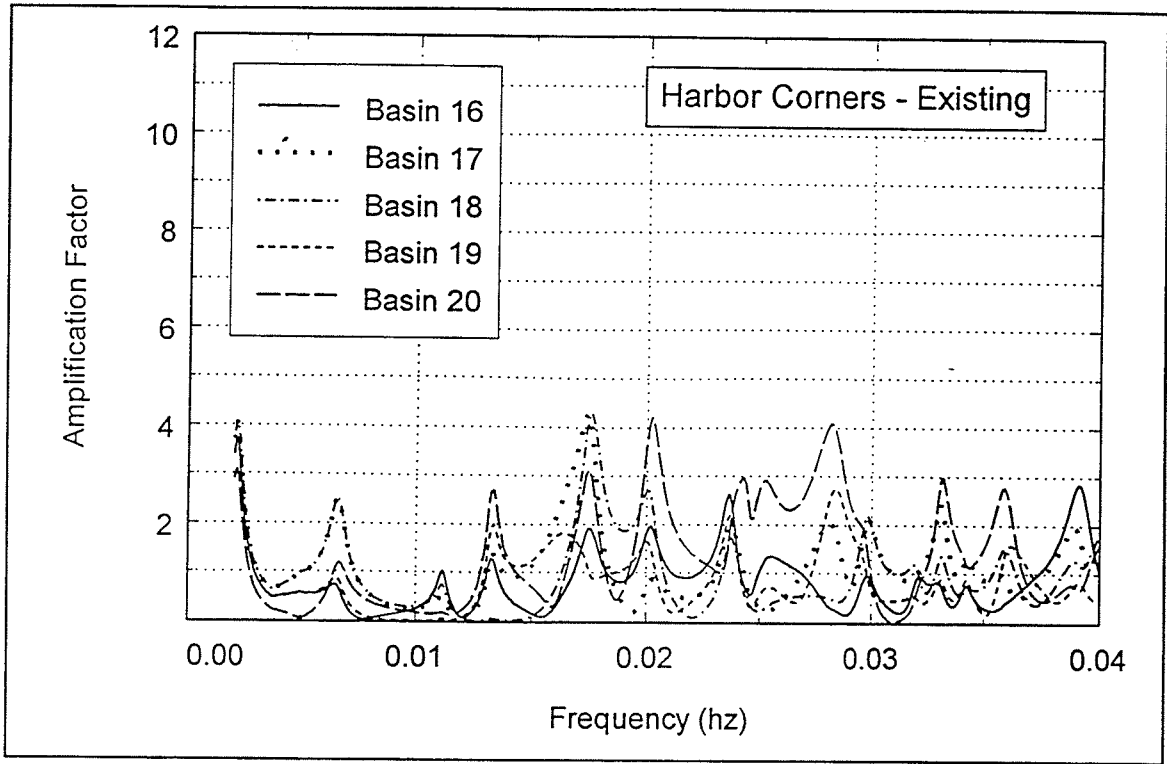

Figure C9. Long wave response, harbor corners, existing harbor

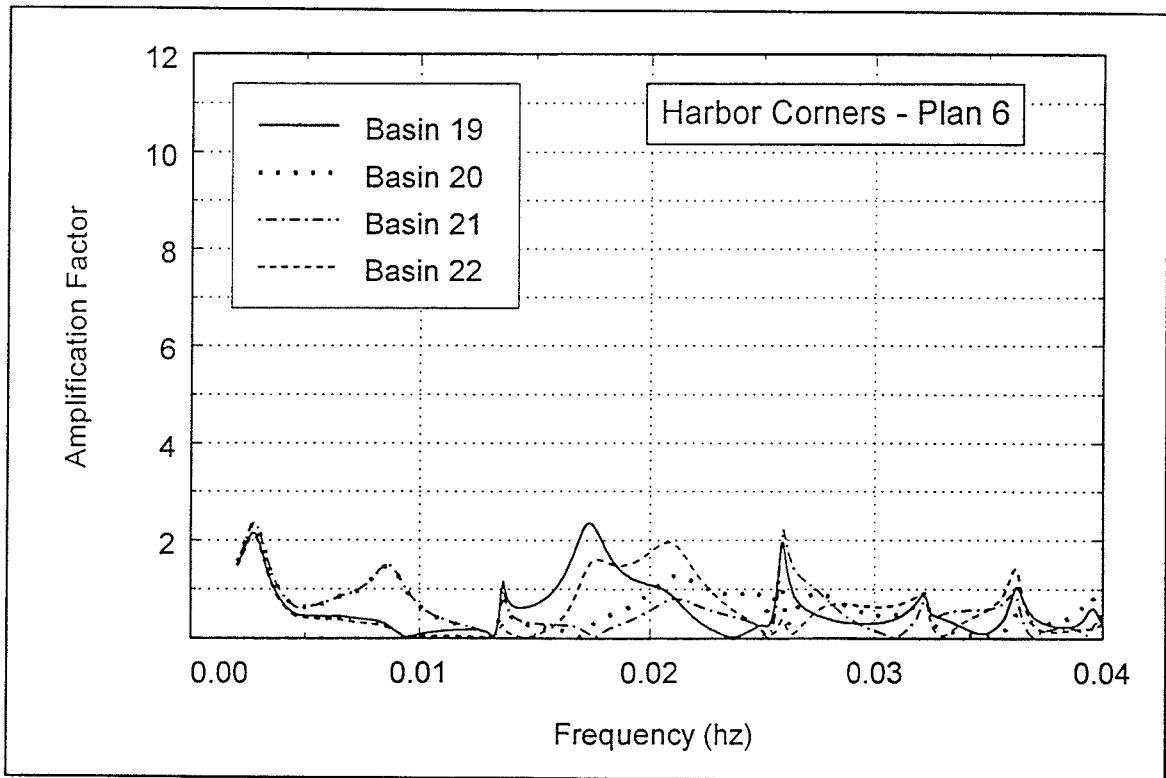

Figure C10. Long wave response, harbor corners, Plan 6



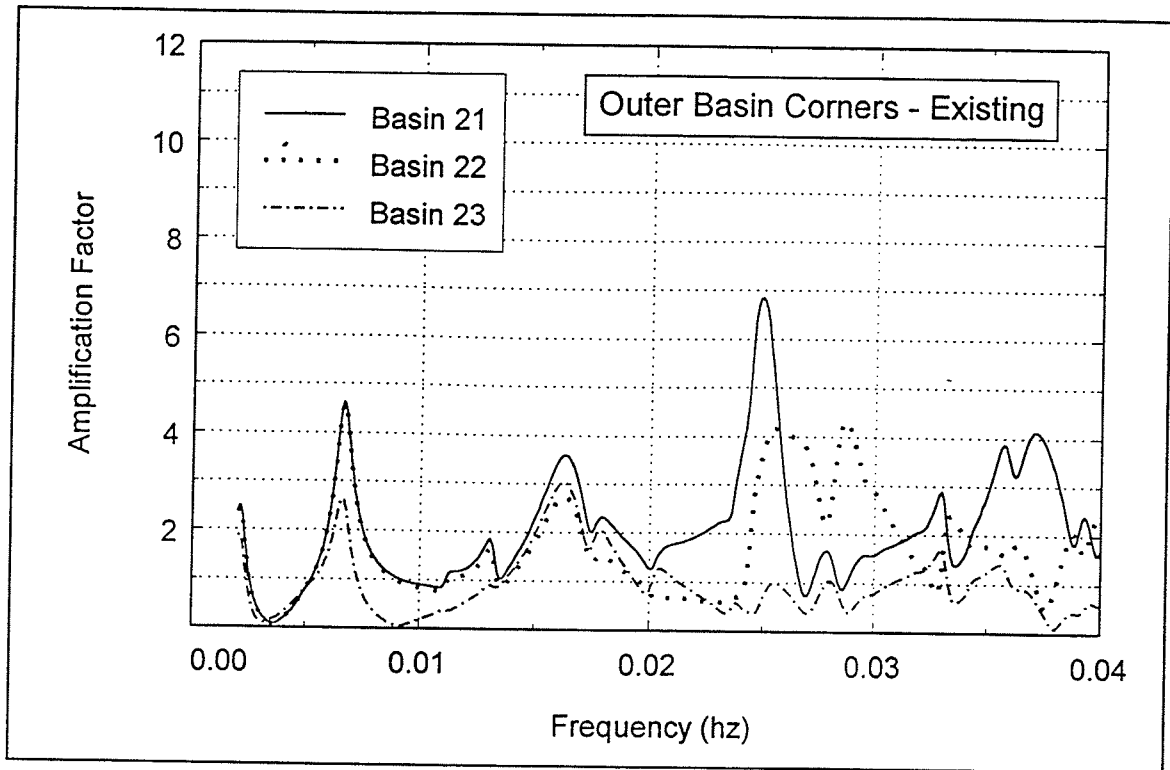

Figure C11. Long wave response, outer basin corners, existing harbor

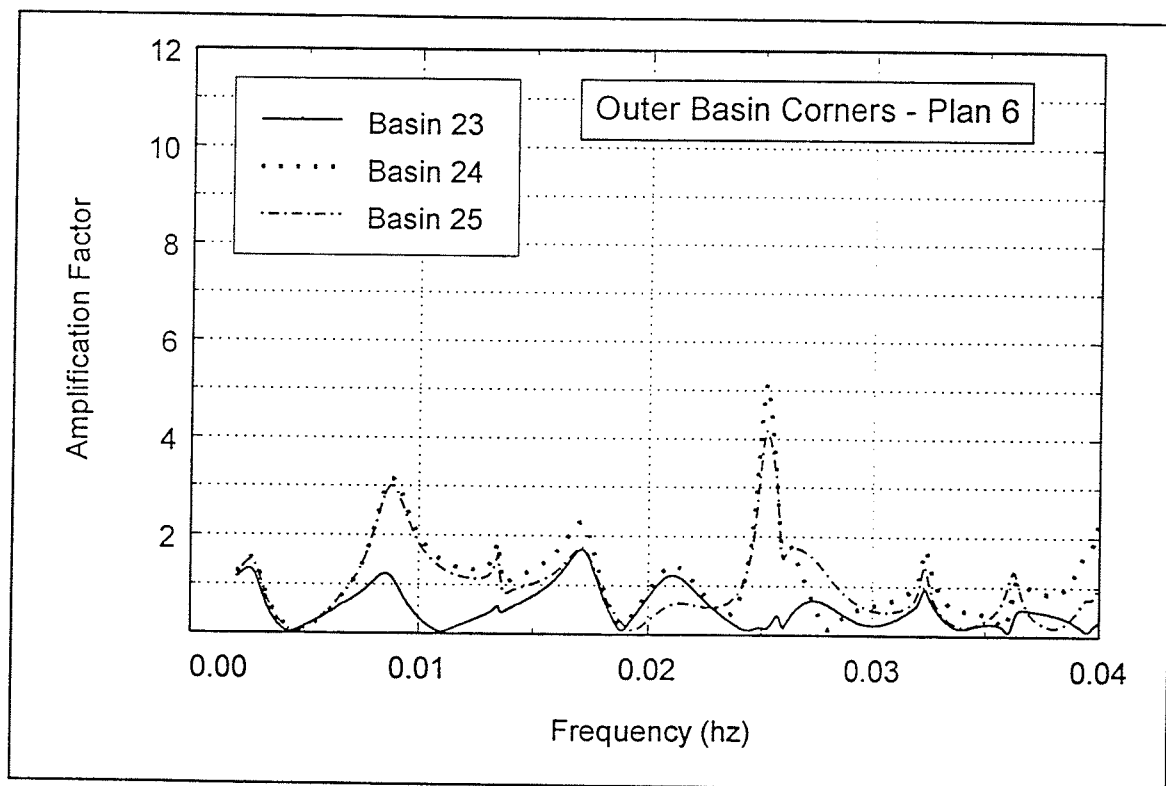
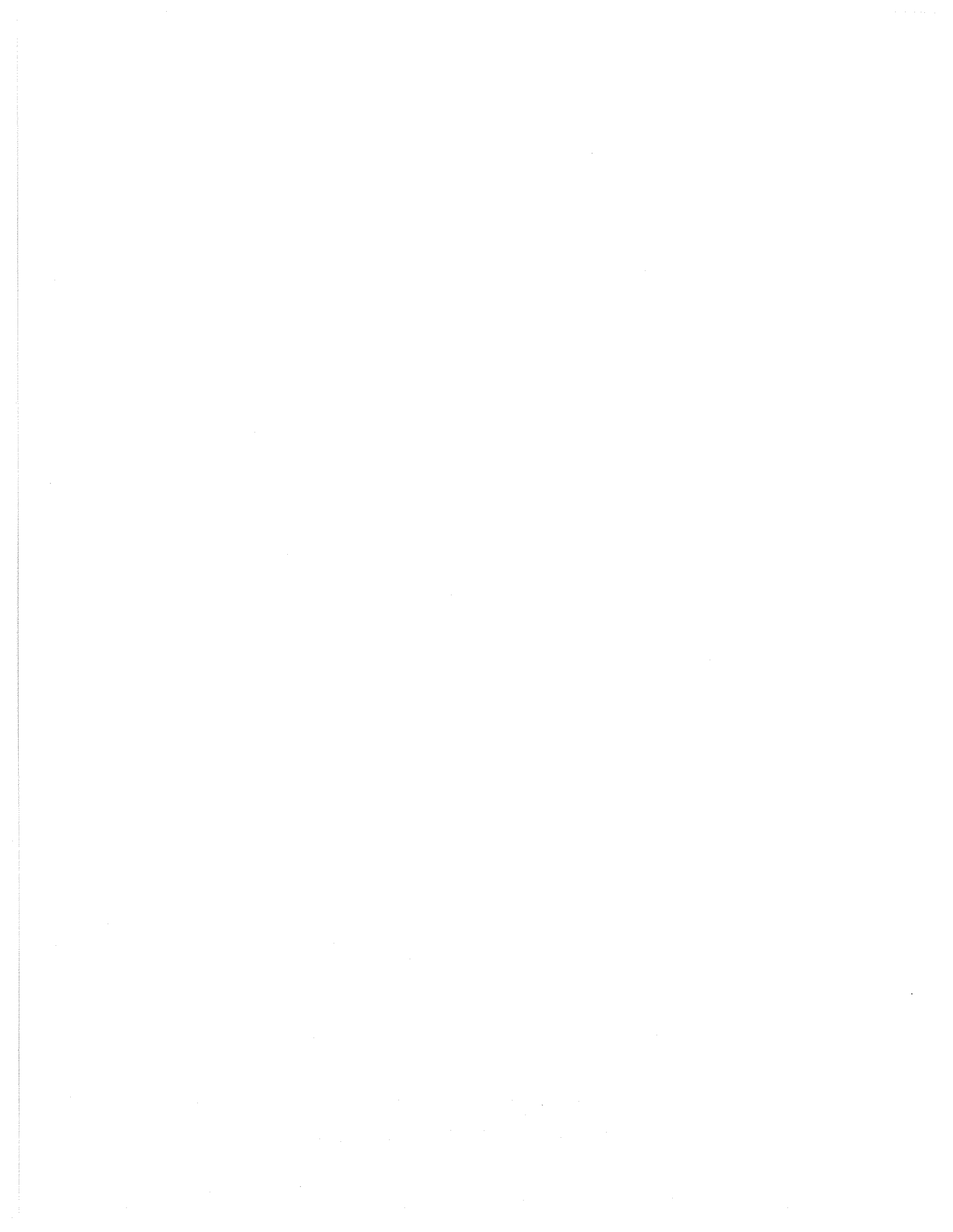

Figure C12. Long wave response, outer basin corners, Plan 6



# Appendix D

## Notation

---

$a$	Wave amplitude, m (ft)
$a_i$	Incident wave amplitude, m (ft)
$A_{amp}$	Wave amplification factor
$(A_{amp})_{eff}$	Effective, or spectral, wave amplification factor
$A_{amp,l}$	Wave amplification factor, long waves (harbor oscillations)
$d$	Water depth, m (ft)
$d_{far}$	Water depth far away from harbor, m (ft)
$f$	Wave frequency, Hz
$H$	Wave height, m (ft)
$H_i$	Incident wave height, m (ft)
$H_s$	Significant wave height, m (ft)
$K_r$	Reflection coefficient of a solid boundary
$K_{r,coast}$	Reflection coefficient of coastline far away from harbor
$N_D$	Number of HARBD computational wave directions for spectral approximation
$N_T$	Number of HARBD computational wave periods for spectral approximation
$s$	Directional spreading factor
$T_m$	Mean spectral wave period, sec
$T_p$	Peak spectral wave period, sec
$w_k$	Weighting factor for $k$ 'th HARBD computational frequency
$\beta$	Dimensionless bottom friction coefficient
$\gamma$	Spectral peak enhancement factor
$\theta_m$	Mean wave direction
$\phi$	Velocity potential
$\psi$	Wave phase



# REPORT DOCUMENTATION PAGE

*Form Approved*  
OMB No. 0704-0188

Public reporting burden for this collection of information is estimated to average 1 hour per response, including the time for reviewing instructions, searching existing data sources, gathering and maintaining the data needed, and completing and reviewing the collection of information. Send comments regarding this burden estimate or any other aspect of this collection of information, including suggestions for reducing this burden, to Washington Headquarters Services, Directorate for Information Operations and Reports, 1215 Jefferson Davis Highway, Suite 1204, Arlington, VA 22202-4302, and to the Office of Management and Budget, Paperwork Reduction Project (0704-0188), Washington, DC 20503.

<b>1. AGENCY USE ONLY (Leave blank)</b>		<b>2. REPORT DATE</b> September 1998	<b>3. REPORT TYPE AND DATES COVERED</b> Final report	
<b>4. TITLE AND SUBTITLE</b> Wave Response of Kikiaola Harbor, Kauai, Hawaii			<b>5. FUNDING NUMBERS</b>	
<b>6. AUTHOR(S)</b> Edward F. Thompson, Lihwa Lin, Lori L. Hadley, Jon M. Hubertz				
<b>7. PERFORMING ORGANIZATION NAME(S) AND ADDRESS(ES)</b> U.S. Army Engineer Waterways Experiment Station 3909 Halls Ferry Road, Vicksburg, MS 39180-6199			<b>8. PERFORMING ORGANIZATION REPORT NUMBER</b> Miscellaneous Paper CHL-98-5	
<b>9. SPONSORING/MONITORING AGENCY NAME(S) AND ADDRESS(ES)</b> U.S. Army Engineer Division, Pacific Ocean Building 230 Fort Shafter, HI 96858-5440			<b>10. SPONSORING/MONITORING AGENCY REPORT NUMBER</b>	
<b>11. SUPPLEMENTARY NOTES</b> Available from National Technical Information Service, 5285 Port Royal Road, Springfield, VA 22161.				
<b>12a. DISTRIBUTION/AVAILABILITY STATEMENT</b> Approved for public release; distribution is unlimited.			<b>12b. DISTRIBUTION CODE</b>	
<b>13. ABSTRACT (Maximum 200 words)</b>  The U.S. Army Engineer Division, Pacific Ocean, is evaluating possible improvements to Kikiaola Harbor, Kauai, Hawaii. Objectives include (a) reducing shoaling in the entrance and harbor, and (b) reducing the frequency of occurrence of breaking waves near the harbor entrance. The Pacific Ocean Division requested that the U.S. Army Engineer Waterways Experiment Station numerically study two proposed plans for improvement, including modifications to the existing entrance (Plan 1) and an extended east breakwater affording vessel access to the harbor from the west rather than the south (Plan 6).  Wind wave and swell conditions were studied in the existing and plan harbors. The standard criterion for wave height in berthing areas was satisfied by all of the harbor configurations. The plan configurations generally satisfied the standard criterion for entrance and access channels except the most seaward part of the entrance channel slightly exceeded the criterion. The existing entrance failed to meet the criterion. Harbor oscillations were studied in only the existing and Plan 6 harbors. Both configurations are free of oscillation problems inside the harbor.				
<b>14. SUBJECT TERMS</b> Harbor resonance                      Numerical modeling Kikiaola Harbor                      Wind waves and swell			<b>15. NUMBER OF PAGES</b> 74	
			<b>16. PRICE CODE</b>	
<b>17. SECURITY CLASSIFICATION OF REPORT</b> UNCLASSIFIED	<b>18. SECURITY CLASSIFICATION OF THIS PAGE</b> UNCLASSIFIED	<b>19. SECURITY CLASSIFICATION OF ABSTRACT</b>	<b>20. LIMITATION OF ABSTRACT</b>	

