

# Special Report 79-22

July 1979

## DETERMINATION OF FROST PENETRATION BY SOIL RESISTIVITY MEASUREMENTS

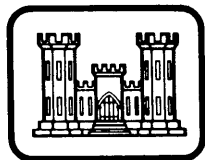

UNITED STATES ARMY  
CORPS OF ENGINEERS  
COLD REGIONS RESEARCH AND ENGINEERING LABORATORY  
HANOVER, NEW HAMPSHIRE, U.S.A.



REPORT DOCUMENTATION PAGE		READ INSTRUCTIONS BEFORE COMPLETING FORM
1. REPORT NUMBER Special Report 79-22	2. GOVT ACCESSION NO.	3. RECIPIENT'S CATALOG NUMBER
4. TITLE (and Subtitle) DETERMINATION OF FROST PENETRATION BY SOIL RESISTIVITY MEASUREMENTS		5. TYPE OF REPORT & PERIOD COVERED
		6. PERFORMING ORG. REPORT NUMBER
7. AUTHOR(*)  Ronald T. Atkins		8. CONTRACT OR GRANT NUMBER(*)
		9. PERFORMING ORGANIZATION NAME AND ADDRESS U.S. Army Cold Regions Research and Engineering Laboratory Hanover, New Hampshire 03755
11. CONTROLLING OFFICE NAME AND ADDRESS U.S. Army Cold Regions Research and Engineering Laboratory Hanover, New Hampshire 03755		10. PROGRAM ELEMENT, PROJECT, TASK AREA & WORK UNIT NUMBERS  DA Project 4A161101A91D
		12. REPORT DATE July 1979
14. MONITORING AGENCY NAME & ADDRESS (if different from Controlling Office)		13. NUMBER OF PAGES 12
		15. SECURITY CLASS. (of this report)  Unclassified
15a. DECLASSIFICATION/DOWNGRADING SCHEDULE		
16. DISTRIBUTION STATEMENT (of this Report)  Approved for public release; distribution unlimited.		
17. DISTRIBUTION STATEMENT (of the abstract entered in Block 20, if different from Report)		
18. SUPPLEMENTARY NOTES		
19. KEY WORDS (Continue on reverse side if necessary and identify by block number) Cold regions                                        Measurement Detectors    Soils Electrical resistivity Freezing Frost		
20. ABSTRACT (Continue on reverse side if necessary and identify by block number) Because of freezing point depression and isothermal springtime conditions, frost penetration measurements using temperature-sensing devices can become unreliable. In recognition of this problem two sensors that depend on changes in soil resistivity were tested. Tests were conducted under a parking area with an asphalt-concrete surface where salt was periodically applied as part of snow removal operations. For comparison, data were obtained from a resistivity probe, a thermocouple probe and a thermistor probe. Results indicated that		

## 20. Abstract (cont'd).

measuring temperature to determine frost penetration can lead to large errors under some conditions, for instance when salt has been applied or when frost is coming out of the ground in spring. The resistivity probe performed reliably during the entire measurement program. It was concluded that resistivity probes have definite advantages which should be considered when future frost penetration measurement programs are designed.

## Preface

This report was prepared by Ronald T. Atkins (Electronic Engineer), Chief, Technical Services Division, U.S. Army Cold Regions Research and Engineering Laboratory. The work was funded under DA Project 4A161101A91D, In-house Independent Research. The data presented in the report were acquired as part of a larger study on frost penetration phenomena conducted jointly with Wayne Tobiasson, Research Civil Engineer, Civil Engineering Research Branch, Experimental Engineering Division, CRREL.

The author thanks Richard Guyer and Bryan Harrington for meticulously recording and plotting the data, and Alan Greatorex for his capable, careful installation of the test probes. The report was reviewed technically by Dr. Richard Berg and Wayne Tobiasson.

The contents of this report are not to be used for advertising or promotional purposes. The citation of trade names does not constitute an official endorsement or approval of the use of such commercial products.

## Introduction

A widely used method for determining frost penetration into the ground during winter relies on measuring temperature as a function of depth. This method assumes that temperatures below  $0.0^{\circ}\text{C}$  indicate frozen soil. Figure 1 is a typical plot of temperature vs depth for Hanover, N.H., in midwinter. It shows that frost has penetrated to a depth of 74 cm.

However, frost penetration determinations that rely on temperature measurements have two disadvantages:

1. Salts or other impurities in the soil/water system may depress the freezing point below  $0.0^{\circ}$ .
2. During spring thaw, subsurface temperatures often become nearly isothermal at  $0.0^{\circ}\text{C}$  (see Fig. 2), making it difficult to establish the frost line.

The problem of freezing point depression can be partially solved by taking soil samples and measuring their actual freezing temperature. But even then the non-homogeneity of the soil plus the changing springtime groundwater conditions may cause uncertainties to remain. The problem is further complicated by the requirement that the temperature measurements be very accurate. For instance, in Figure 1 an uncertainty of  $\pm 0.25^{\circ}\text{C}$  (typical for a thermocouple measurement) would lead to a frost depth uncertainty of approximately 5 centimeters. The same  $\pm 0.25^{\circ}\text{C}$  uncertainty under the springtime conditions of Figure 2 would lead to a frost depth uncertainty of approximately 40 centimeters.

The desire to make frost penetration determinations independent of temperature measurements has led to the development and use of a series of soil resistivity probes. This report describes two of the probes developed, gives the results of the initial test program, and makes recommendations for future work.

## Theoretical Considerations

Distilled water has a relatively high volumetric resistivity, on the order of several hundred megohms. However, for water containing even small concentrations of impurities, such as is normally found in soils, the volumetric resistivity drops to values typically around 20,000 ohms. If this groundwater is then frozen, the mobility of the charge carrier becomes severely restricted so that the volumetric resistivity rises abruptly. Typical volumetric resistivities for frozen groundwater are greater than 100,000 ohms and often may be as high as several megohms (1 megohm = 1,000,000 ohms).

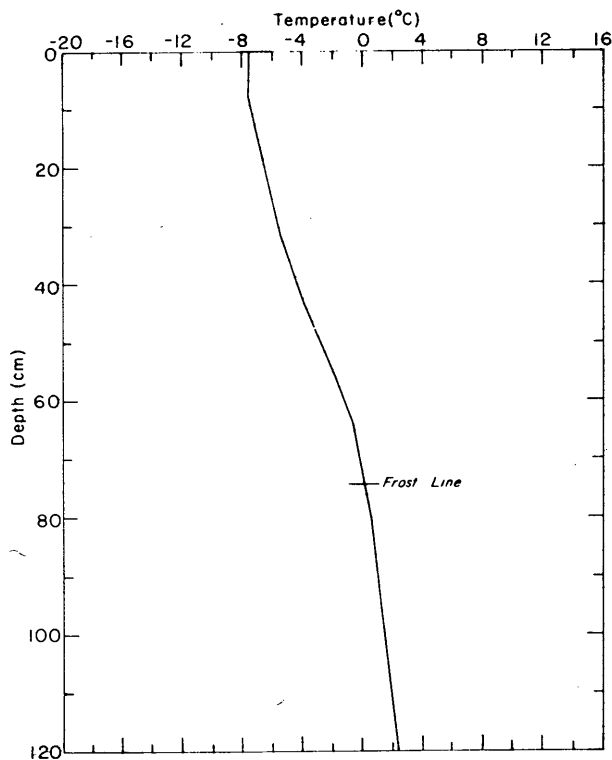

Figure 1. Typical temperature vs depth curve during winter months.

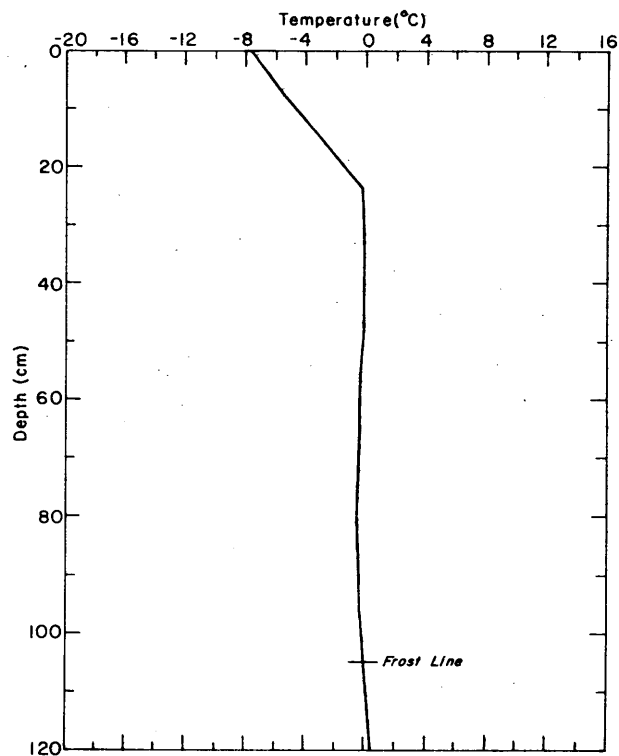

Figure 2. Typical temperature vs depth curve during springtime conditions.

Since the electrical resistance of soil moisture rises sharply when the water freezes, the state of subsurface water can be determined by taking resistance measurements. The sensing surfaces can be fixed plates, bare wires or any other type of electrical conductor. The spacing between these surfaces must be held constant and good contact must be maintained between the surfaces and the soil. Under these conditions the resistance between the sensing surfaces (as sensed by an external circuit) can be determined by a composite resistivity term consisting of several parameters. For instance the value will depend in part on the resistivity of the soil itself, the resistivity of the water, the percent moisture content, and the resistivity of any ice crystals present.

The volumetric resistivity of dry bulk soils is normally very high, on the order of several megohms. Therefore, soil resistivity does not play much of a part in determining subsurface soil resistance. On the other hand, the resistivity of the groundwater is relatively small, so if it is present to any appreciable extent it will be the primary factor in determining the resistivity of the soil/water system. As this groundwater begins to form ice crystals and finally freezes, the resistance, as read by an external circuit, will increase in relative proportion to the number of ice crystals formed. This process will continue until the resistance finally becomes stable at some large ohmic value determined by the resistivity of the soil-ice mixture. Figure 3 shows this situation schematically for typical conditions in an area where frost action is in progress.

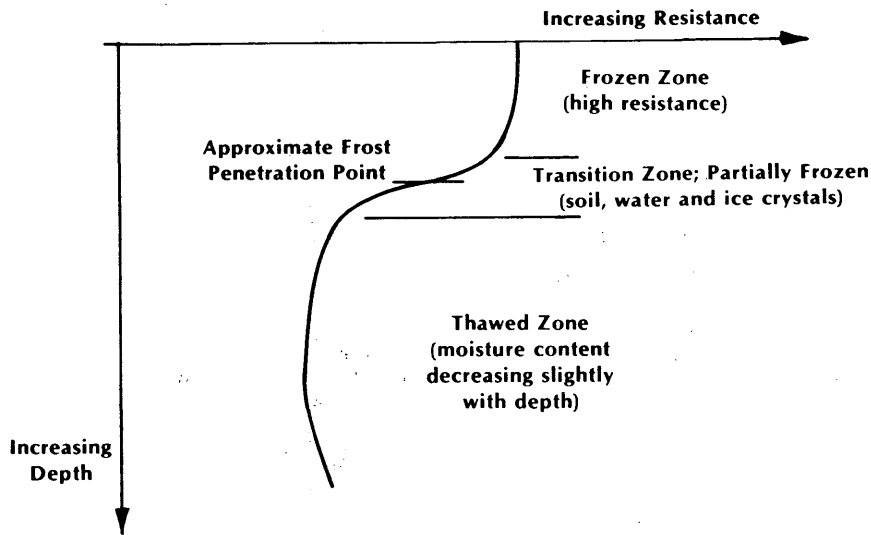

Figure 3. Typical resistance vs depth curve.

No absolute resistance measurements are necessary to determine frost penetration by this method since it is the shape of the resistance vs depth curve that is important. Nevertheless, it is necessary to consider the method for making the external resistance measurements.

If direct current resistance measurements are used, the groundwater will almost certainly become polarized, leading to erratic, non-repeatable and misleading resistance measurements. Therefore, resistance measurements can not be made with voltohmmeters, digital multimeters, DC bridges, or other commercially available resistance measuring devices which use a direct current voltage source.

Since an alternating current source reverses its polarity each half cycle, it avoids the groundwater polarization problem. With a low frequency AC source, impedance readings due to cable and sensor capacitances can also be avoided. And if a frequency below 60 Hz is used, possible errors due to line frequency and all its harmonics can be filtered out if necessary. Therefore, a low frequency AC resistance measurement is best suited for frost penetration determination using soil resistivity measurements.

### Sensors

Two types of probe assemblies have been used. The initial probe assembly, designed by Mr. Wayne Tobiasson, was fabricated using pieces of copper tubing as the sensing surfaces and pieces of polyethylene tubing as an insulator and spacer. The complete probe was made by alternately telescoping together pieces of copper tubing 3.2 cm long and pieces of polyethylene tubing 3.8 cm long. Diameters were chosen so that the outside diameter of the copper tubing (2.2 cm) was a twist fit for the inside diameter of the polyethylene tubing. The exposed sections of each piece of copper tubing were spaced 5 cm apart along a total length of 105 cm. Individual lead wires (No. 22 AWG with polyvinyl

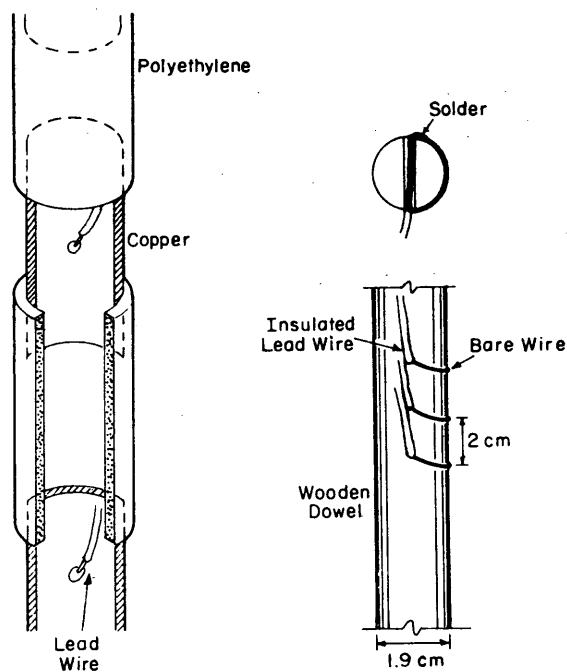

Figure 4. Initial (left) and second generation resistivity probes.

insulation) were soldered to the inside of each copper piece and led up the inside of the "pipe"<sup>2</sup> during assembly. Each sensing surface exposed approximately  $3.5 \text{ cm}^2$  to the soil.

A principal design consideration for the initial probe was providing a large surface to make adequate contact with the soil. Preliminary tests showed that for fine silts a much smaller surface area would suffice. Therefore, a much simpler probe was designed for subsequent tests. This second probe was much easier to fabricate and performed equally as well as the first.

The second generation probe was a wooden dowel 1.9 cm in diameter, in various lengths up to 100 cm. At 2-cm intervals along the entire length of the dowel 1.0-mm holes were drilled diametrically through the dowel. An insulated, solid No. 22 wire was inserted through each drilled hole. The insulation was then stripped off the wire so that the bared section could be wrapped tightly around the circumference of the dowel and soldered back upon itself. This type of probe exposed an area of approximately  $1.0 \text{ cm}^2$  to the soil. Both probes are shown in Figure 4.

The individual lead wires for the sensing surfaces were brought out to terminal strips at a readout station. The wires were connected sequentially to the terminal strips and readings were taken in order between leads 1 and 2, 2 and 3, 3 and 4, etc. for the entire length of the probe. Leads up to 30 m long were used.



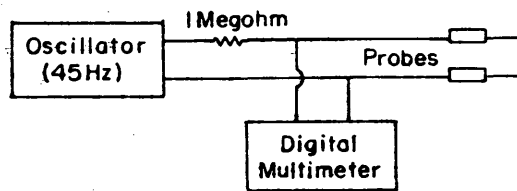

Figure 5. Voltage-ratio circuit for resistivity measurements.

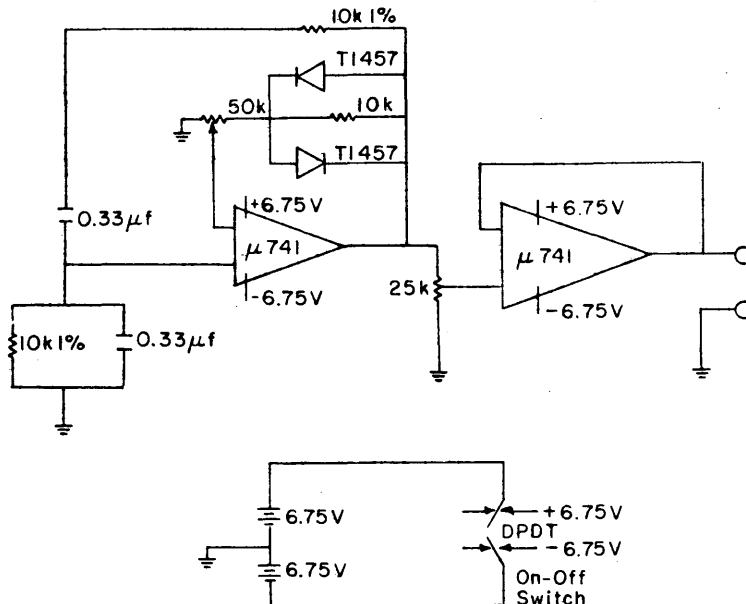

Figure 6. Wien-bridge oscillator circuit for battery-operated measurements.

### Measurement Equipment

Two methods were used to measure soil resistance. Initially a Hewlett-Packard Model 200J Oscillator and a John Fluke Company Model 8600A Digital Multimeter were used. Both of these units operate from 110-V, 60-Hz line power. Later in the test program a battery-operated system consisting of a Wien-bridge oscillator and a Data Precision Company Model 245 Digital Multimeter were used in order to demonstrate the feasibility of taking field measurements.

As discussed previously, it is not necessary to make completely accurate resistance measurements in order to determine frost penetration. The shape of the resistance vs depth curve alone provides the necessary information. Therefore, the actual readings taken were the voltage drops across the unknown soil resistances as compared to the voltage drop across a 1.0-megohm resistor (Fig. 5). The circuit diagram for the Wien-bridge oscillator is shown in Figure 6. Under this arrangement the voltage was read and plotted directly with no intermediate calculations required. A typical plot is shown in Figure 7.

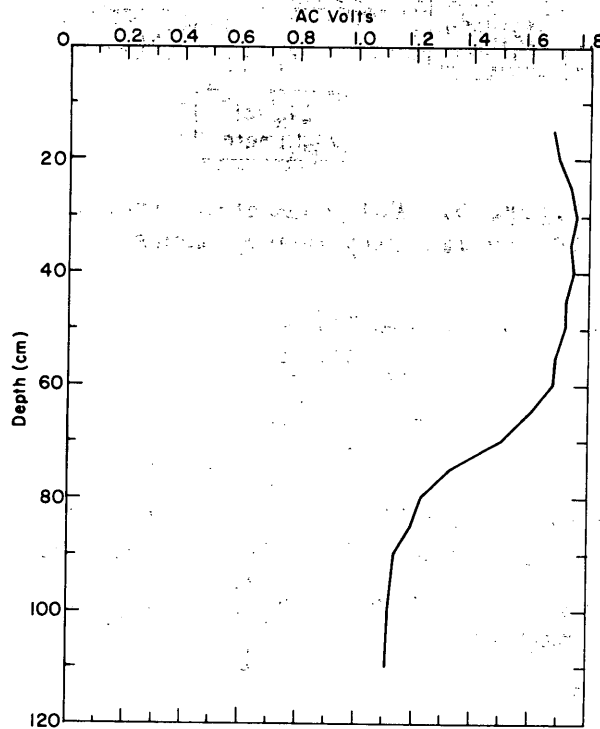

Figure 7. Typical voltage (resistance) vs depth curve during winter season.

The operating frequency was 45 Hz. This frequency was about at the lower limit for the AC voltage ranges of the digital multimeters. At 45 Hz the line frequency could be filtered out and errors due to capacitive effects avoided. The normal operating voltage was 3 V, peak to peak.

#### Test Program

The copper ring probe was tested from January to April 1975 as part of a program evaluating several methods for detecting frost penetration, including a thermistor probe and a thermocouple probe. The site selected was an asphalt concrete-surfaced parking lot at CRREL in Hanover, New Hampshire. This area was kept plowed free of snow and therefore experienced significant frost penetration.

As described earlier, the resistivity probe was 105 cm long with sensing surfaces spaced every 5 cm. The thermocouple and thermistor probes were 120 cm long with their 12 temperature sensors spaced 10 cm apart along their length. The thermistor and thermocouple probes were placed vertically in the ground with their top sensor at the surface. The resistivity probe was placed in the ground so that the mid-point between its top two sensing surfaces was 15 cm below ground level. Therefore, all probes were capable of reading frost penetration to a depth of 120 cm. All three probes were carefully installed and back-filled to ensure good contact with the soil. (Earlier tests had shown that installation was extremely important if reliable, reproducible measurements were to be obtained.) Asphaltic concrete patching material

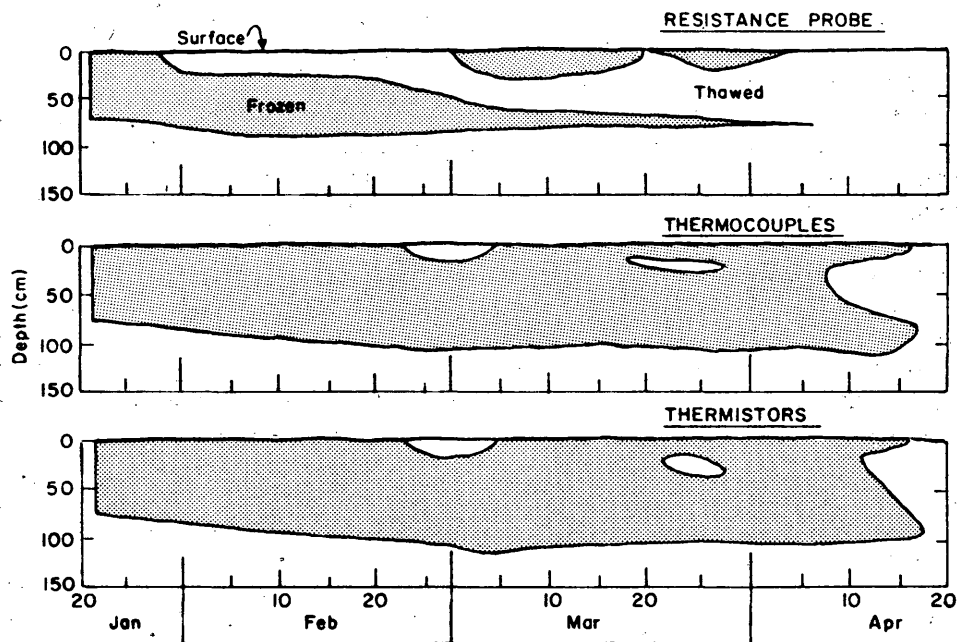

Figure 8. Seasonal frost penetration as seen by a thermistor, a thermocouple, and a resistivity probe.

was used to re-seal the drill holes. The test leads from all three probes were buried 15 cm under the surface and led to the readout station inside the main CRREL building approximately 15 m away. Readings were taken on each probe three times a week from January to April.

#### Analysis of Data

Although it is not necessary to show all the data obtained for the period mid-January to mid-April in order to evaluate the performance of the resistivity gauge, a reasonable sampling is presented in Appendix A. These curves demonstrate how the gauge reacted to significant changes in ground frost and show that the measurements were repeatable from week to week. Comparable data for the thermocouple and thermistor gauges are shown in Appendices B and C. All of these data were used to compile a seasonal graph for each gauge (Fig. 8).

All gauges showed solid freezing down to 75 cm in mid-January. But beginning on 31 January the resistivity gauge began to show a thawed zone from 15 to 25 cm. Neither the thermistor gauge nor the thermocouple gauge indicated this thawing, i.e. both indicated temperatures below  $0^{\circ}\text{C}$ . Subsequent measurements indicated that this discrepancy was real, continuous, and repeatable with respect to each of the three gauges.

This disagreement highlighted the real value of the resistivity gauge. An explanation for the discrepancy was sought, and it was found that a mixture of sand and salt had been put down during snow removal operations on 29 January. The salt had combined with surface meltwater and lowered its freezing point. This salty meltwater had then filtered

down through the cracks in the asphalt concrete into the soil, thawing the soil as it went. As a result, the resistivity gauge "saw" highly conductive salt water, which was correctly read as a thawed condition, while the temperature gauges saw below-freezing temperatures, which led to the incorrect conclusion of frozen conditions. This situation continued through most of February, with the saline meltwater slowly penetrating into the frozen soil beneath it.

On 24 February the weather turned warmer, bringing substantial amounts of relatively salt-free meltwater onto the surface and slightly beneath it. This meltwater raised surface temperatures above the freezing point so that the temperature gauges began to indicate thawing near the surface. At this point in the season all three gauges agreed that thawing had occurred. However, only the resistivity gauge showed that the effects of the salt water had caused thaw to a considerable depth. The resistivity gauge also showed that the warm surface water of 24 February had accelerated the rate at which the thawed zone was penetrating into the frozen soil.

On 5 March all gauges indicated that freezing had once again taken place at the surface (refreezing of the salt-free surface water). The resistivity gauge was readily interpreted as showing a thawed zone between two frozen zones. The temperature data are somewhat difficult to interpret, with the thermistor gauge showing an isothermal condition while the thermocouple gauge showed solid frost down to 104 cm. In fact, from this point on interpretation of the temperature gauges became somewhat uncertain, with clearly defined frost limits almost impossible to determine. The resistivity gauge, on the other hand, continued to show the position of the frost lines with no ambiguity, right up to the point where the ground became completely frost-free.

The success of this initial test program led to the use of resistivity type frost gauges in several laboratory and field test programs during 1976 and 1977. For these programs the simpler wooden dowel gauges were used. These gauges gave curves similar to the ones in this report. These data will be the subject of a later report.

#### Conclusions, Recommendations and Comments

The initial evaluation of the frost resistivity gauge plus experience gained with further use have led to the following conclusions:

1. An AC resistivity gauge can accurately and reliably determine frost penetration.
2. The AC resistivity gauge is superior to temperature measurement gauges for determining the presence of frost under spring thawing conditions.
3. The use of temperature measurement gauges to determine frost depths under asphalt concrete surfaces will lead to erroneous results if salt is used as part of a snow removal program.

Test results and conclusions indicate that the following recommendations are appropriate for future frost measurement programs:

1. The use of both temperature and resistivity gauges is definitely advisable since, in general, one type complements and increases the confidence level of the other in determining maximum frost depth, as for example in Figure 8.

2. Other frost detection methods such as frost tubes should not necessarily be totally excluded in favor of resistivity or temperature gauges in any frost measurement program.

3. In some instances, such as when chemicals are added to the soil/water system, the primary measurement tool for determining frost penetration should be the resistivity gauge.

4. Before the resistivity gauge can be used with complete confidence, two additional areas should be explored and reported on:

A. The minimum amount of soil moisture which must be present in order to make resistance measurements meaningful.

B. The minimum amount of surface area necessary at the sensor/soil interface in order to insure a reliable, repeatable reading.

Appendix A: Resistance Gauge Data

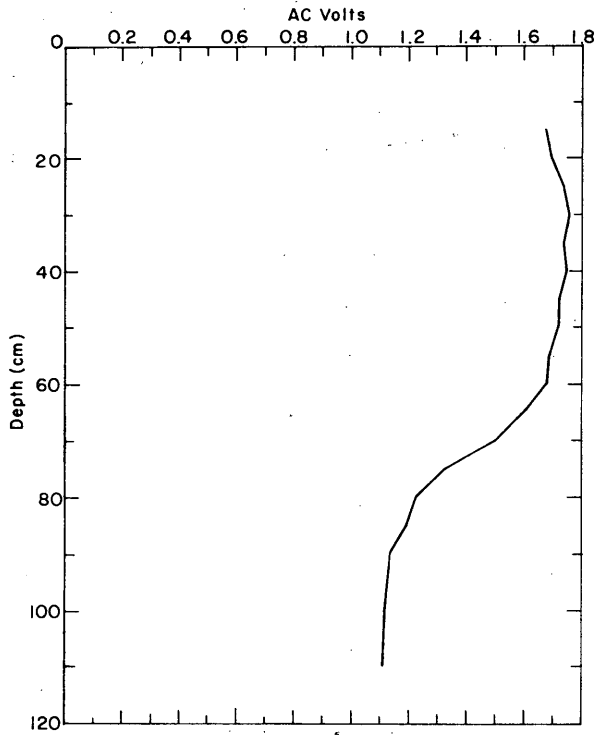

22 Jan 1975

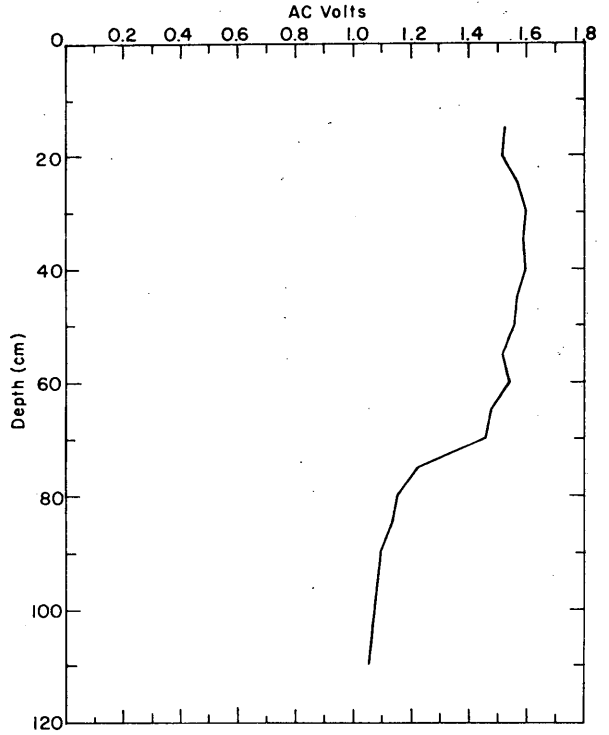

29 Jan 1975

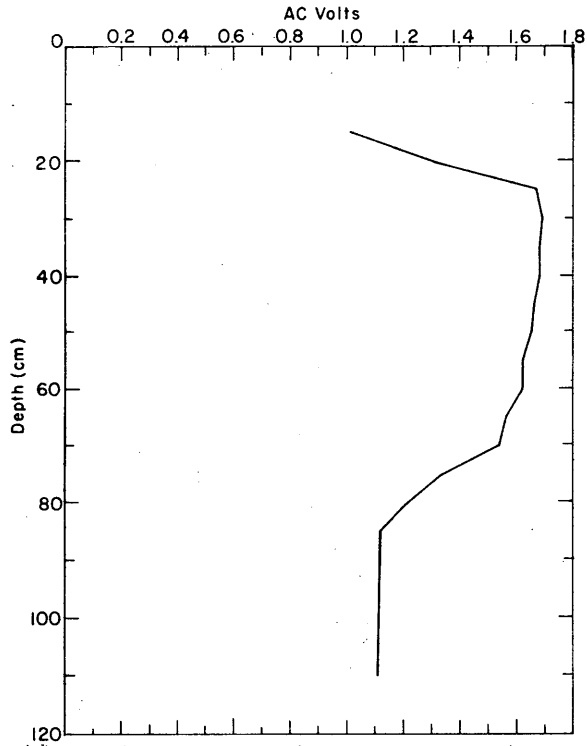

31 Jan 1975

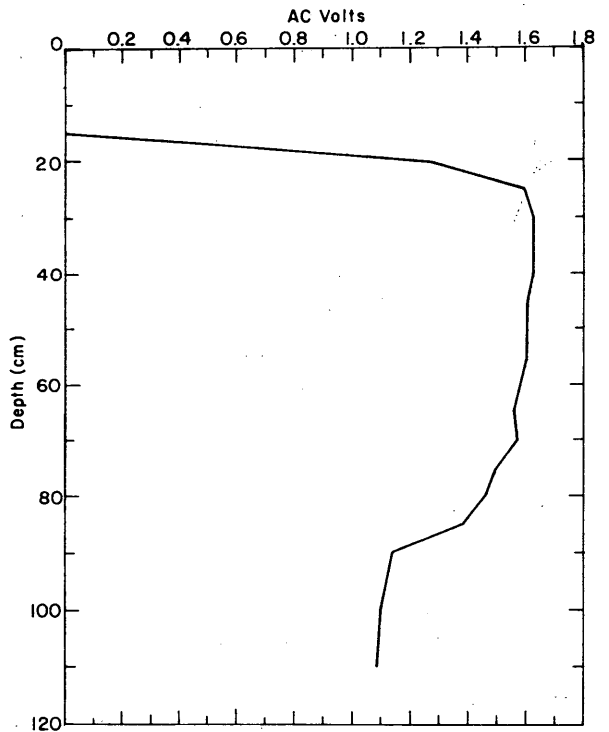

7 Feb 1975

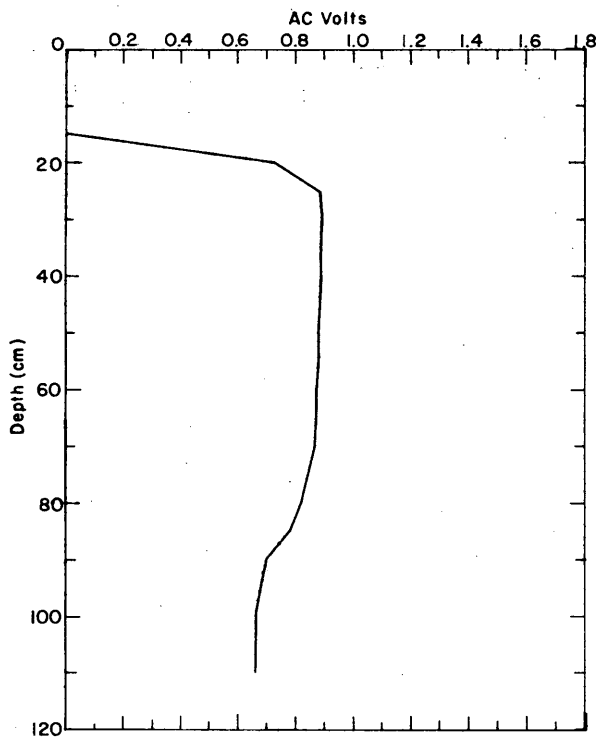

10 Feb 1975

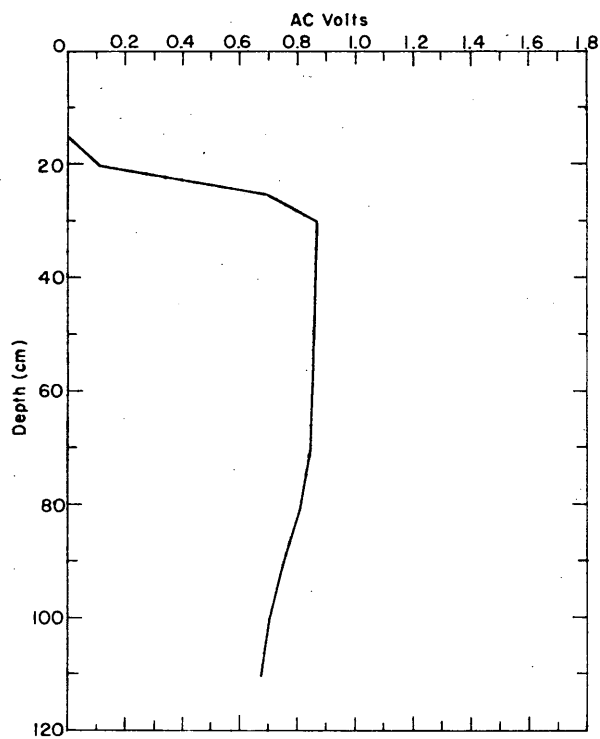

20 Feb 1975

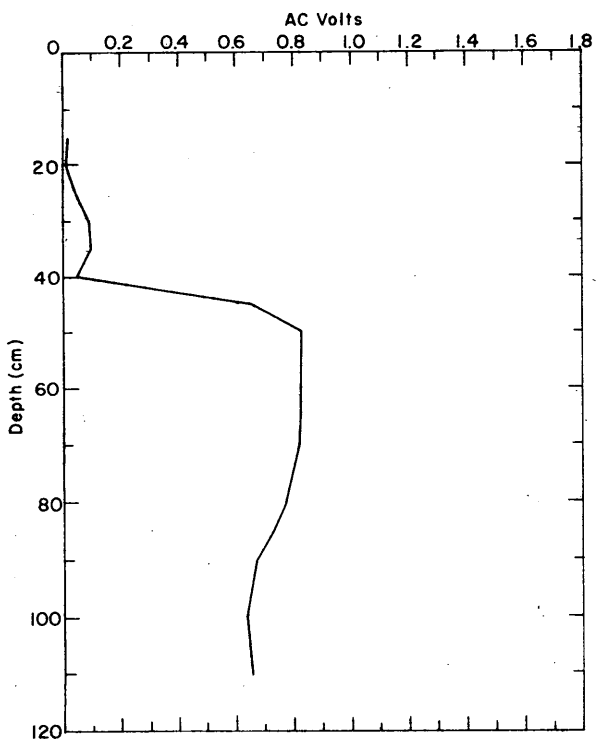

26 Feb 1975

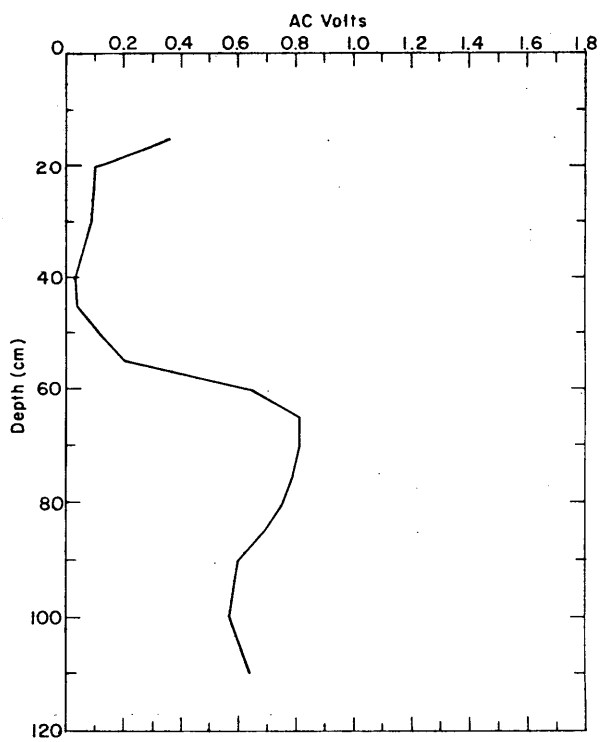

3 Mar 1975

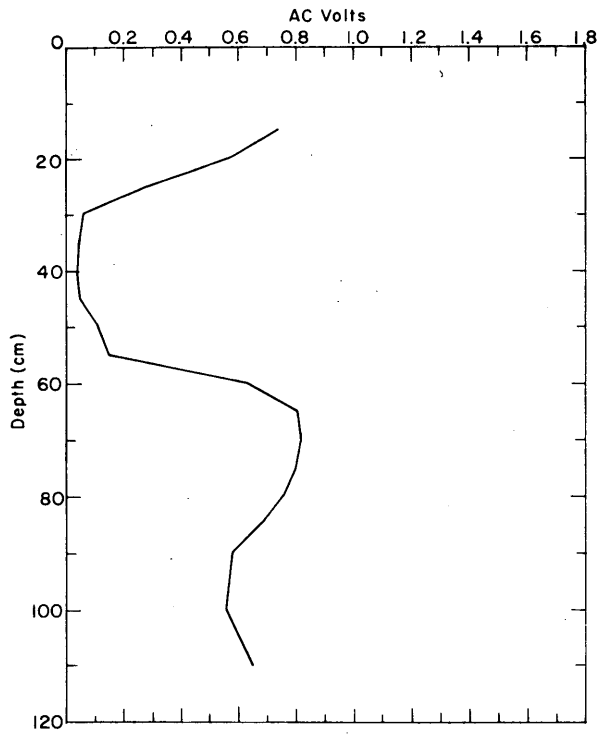

5 Mar 1975

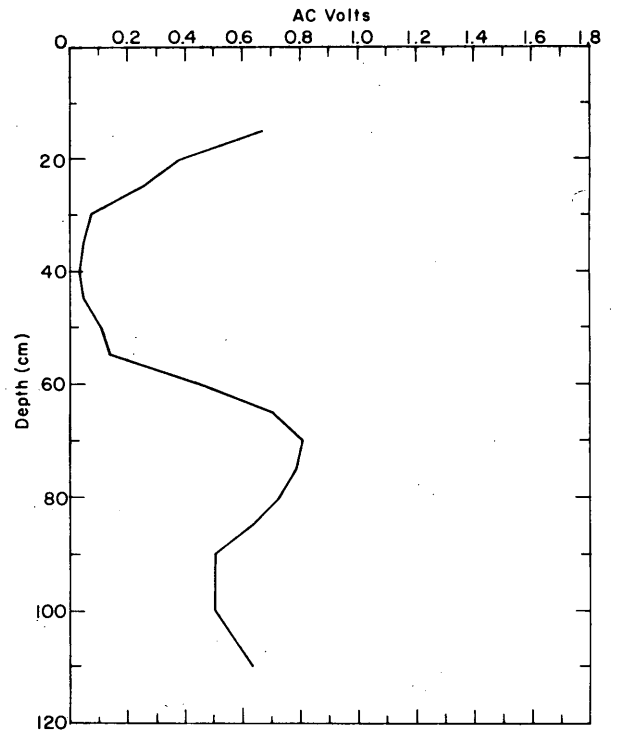

10 Mar 1975

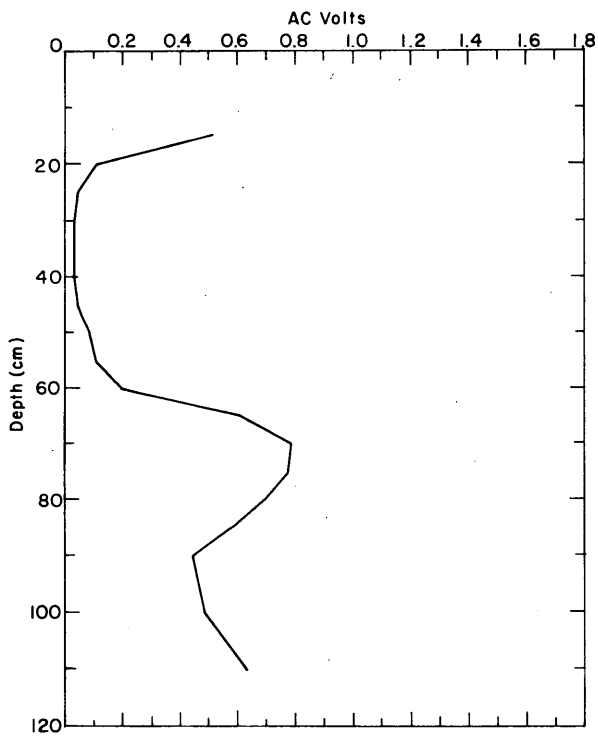

17 Mar 1975

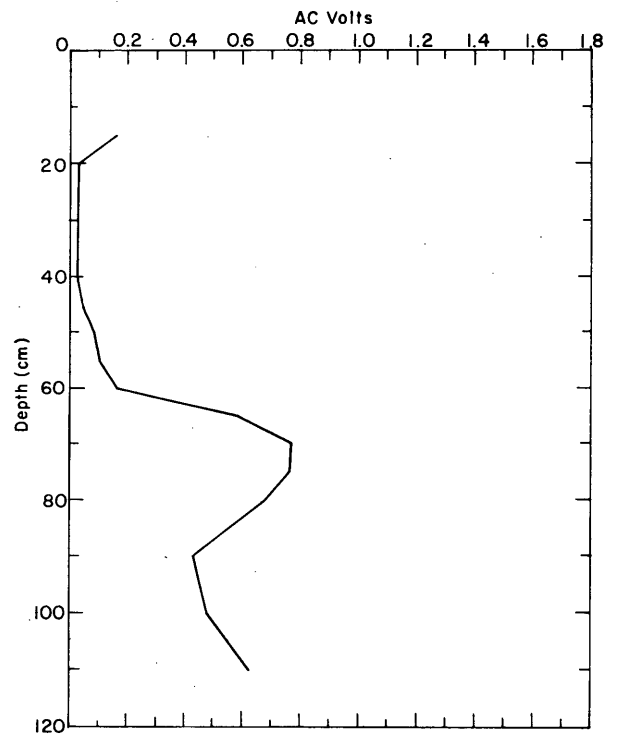

19 Mar 1975



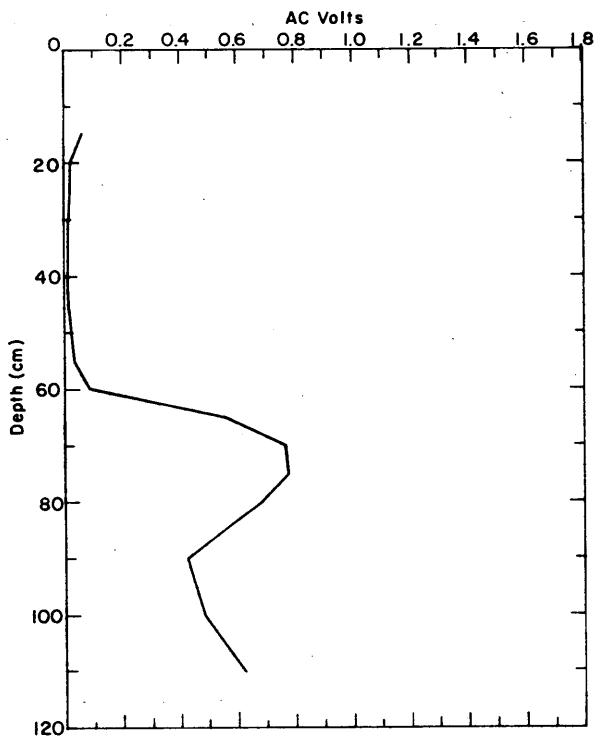

21 Mar 1975

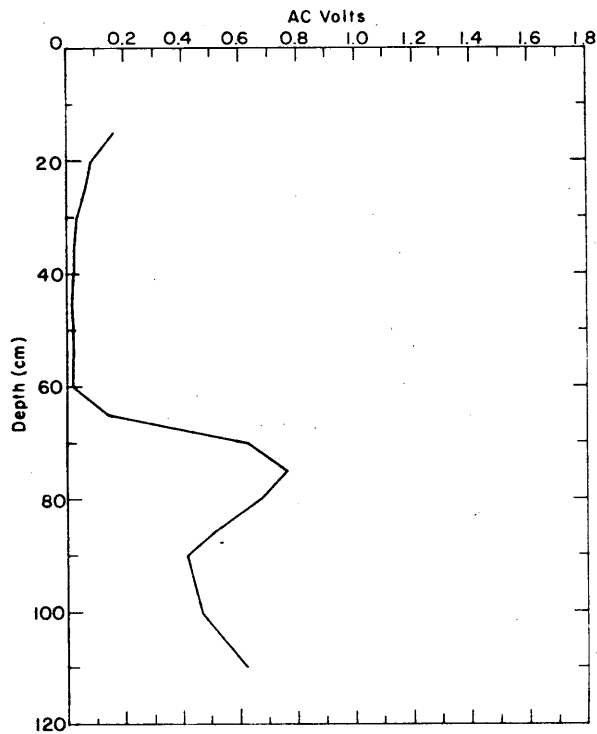

24 Mar 1975

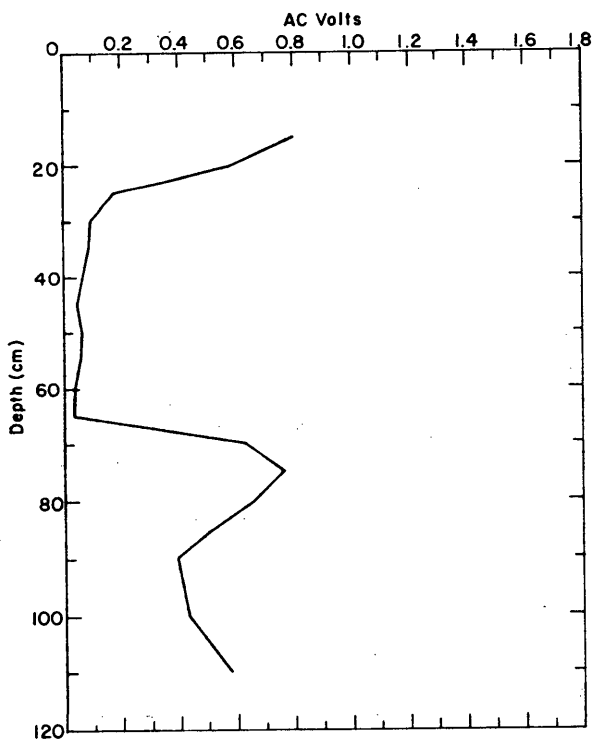

28 Mar 1975

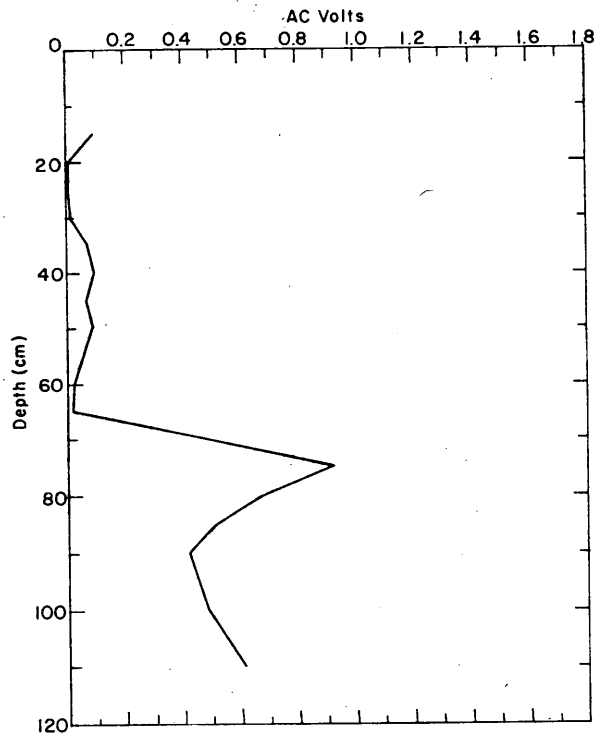

4 April 1975

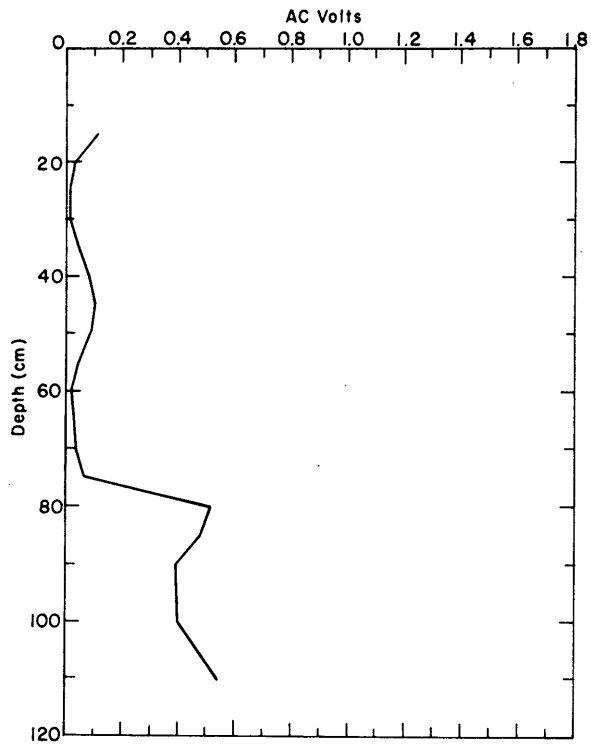

7 April 1975

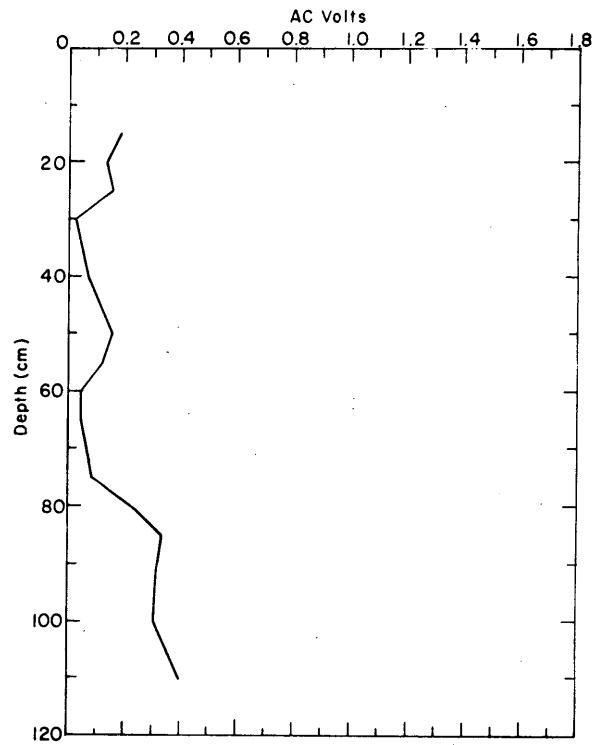

11 April 1975

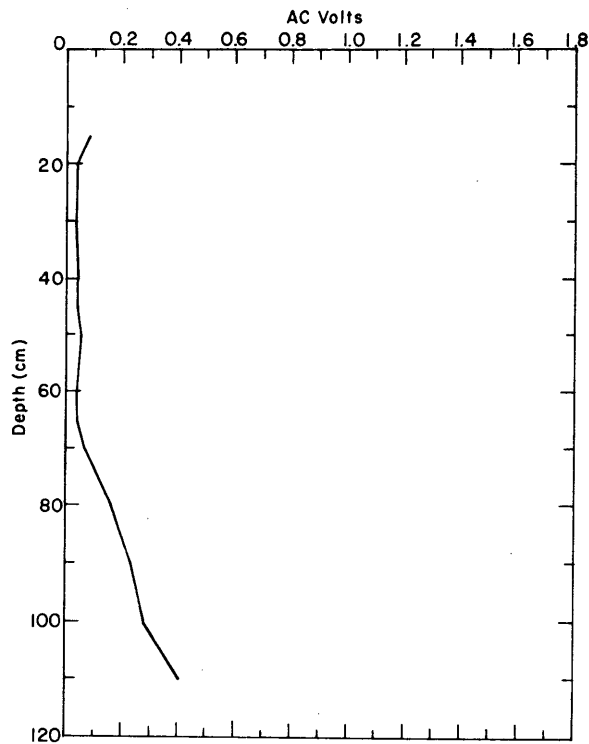

18 April 1975

## Appendix B: Thermocouple Data

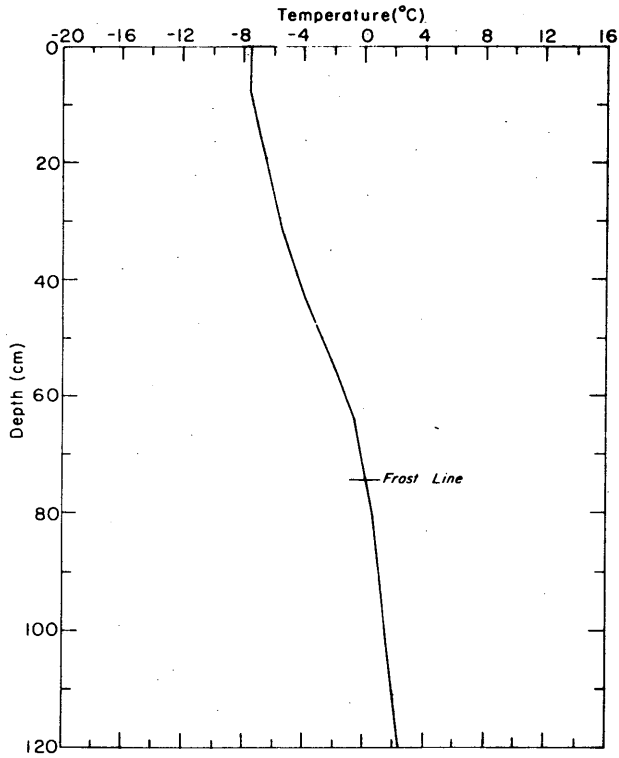

22 Jan 1975

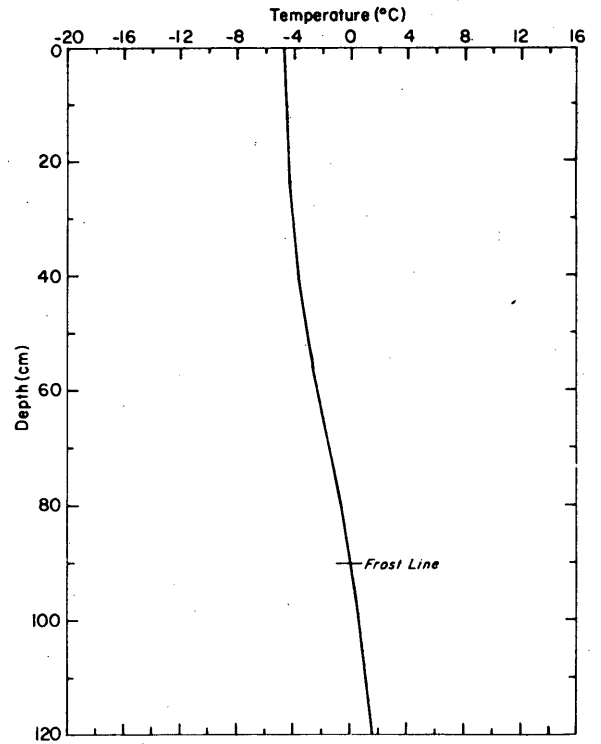

7 Feb 1975

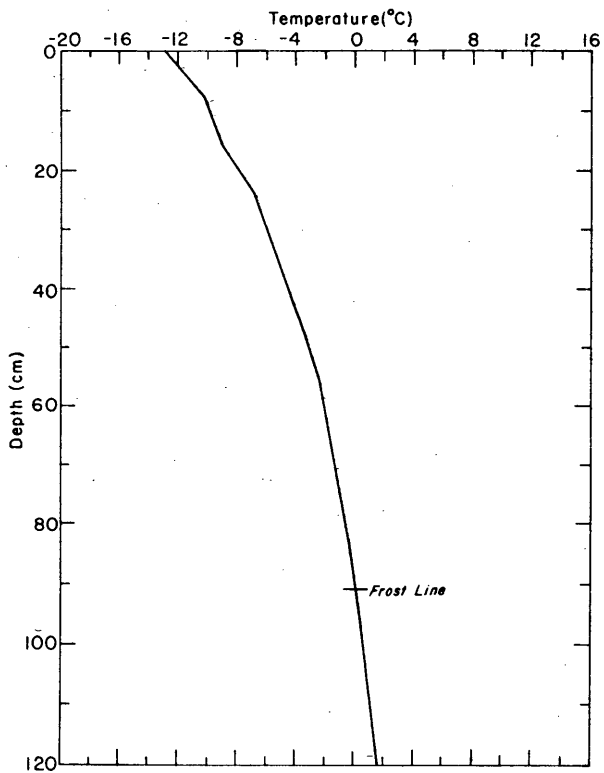

10 Feb 1975

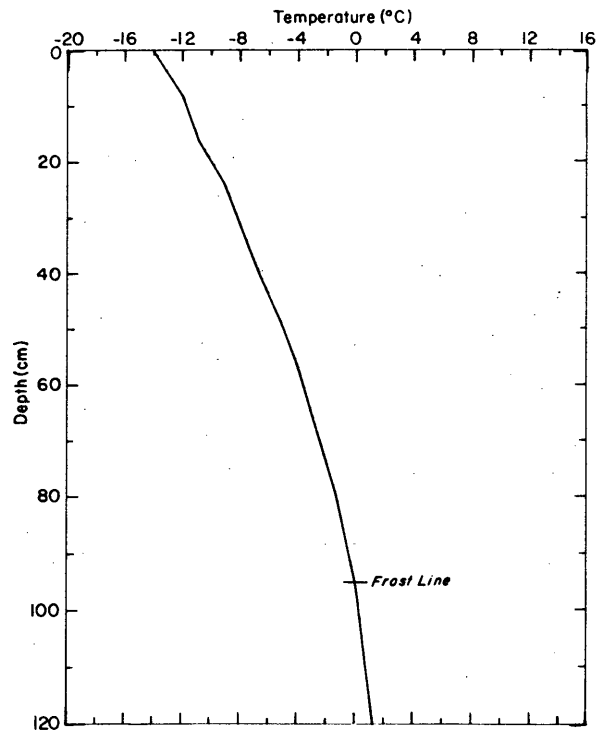

14 Feb 1975

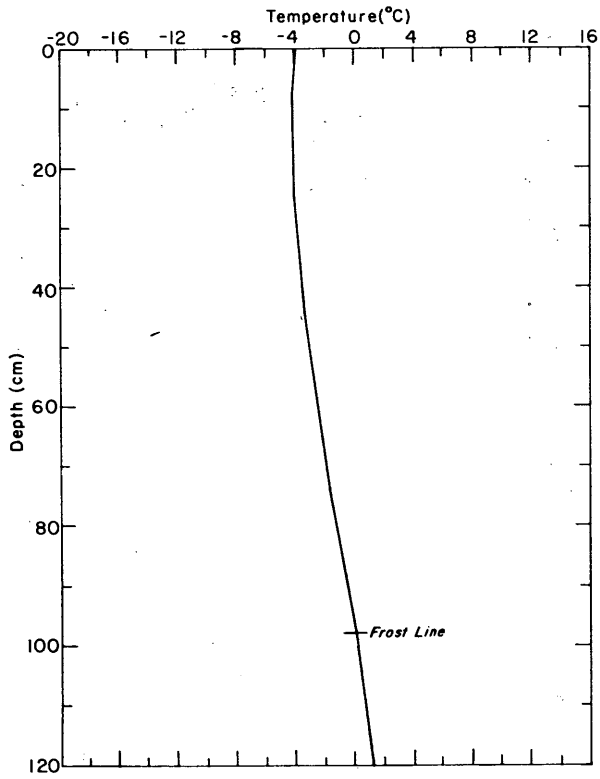

18 Feb 1975

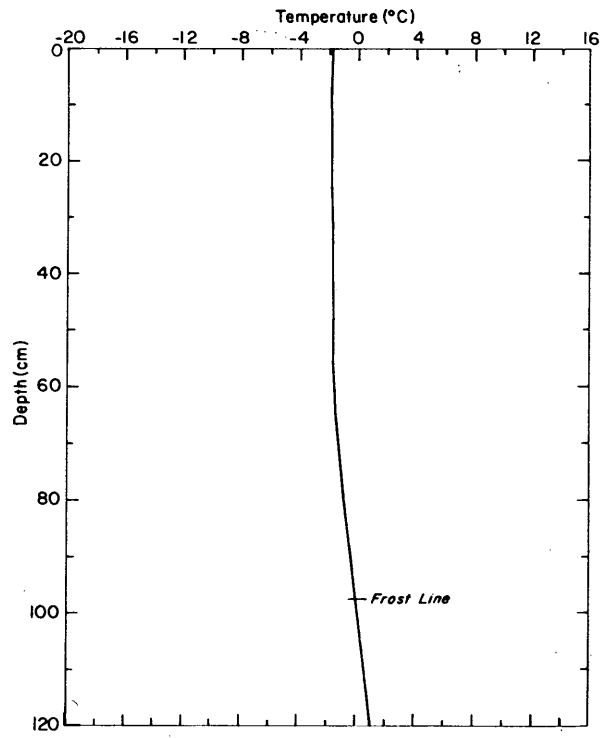

20 Feb 1975

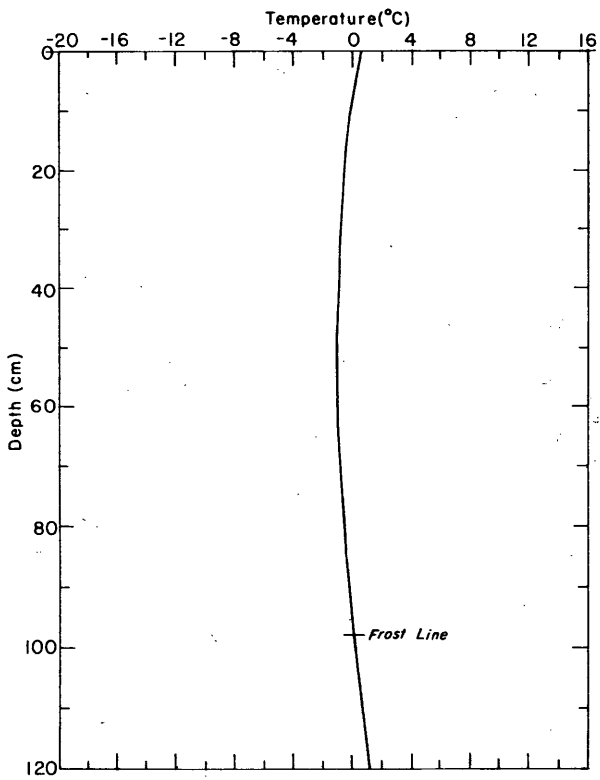

24 Feb 1975

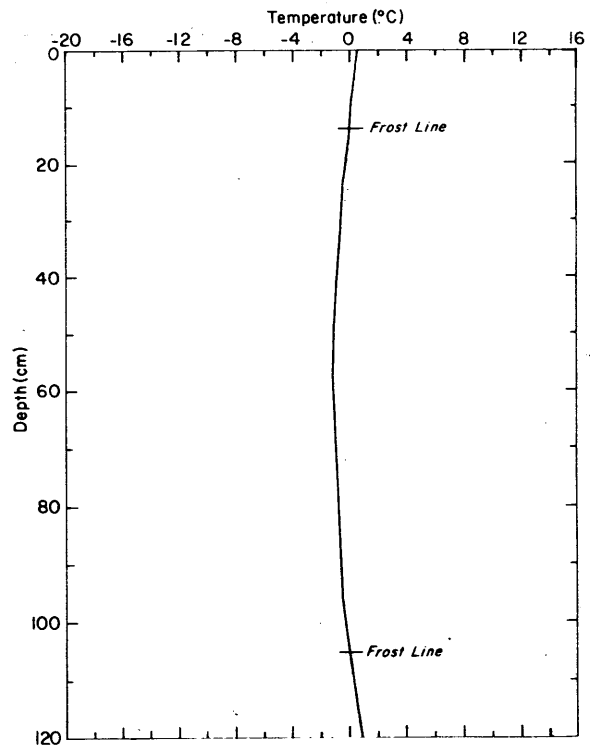

26 Feb 1975

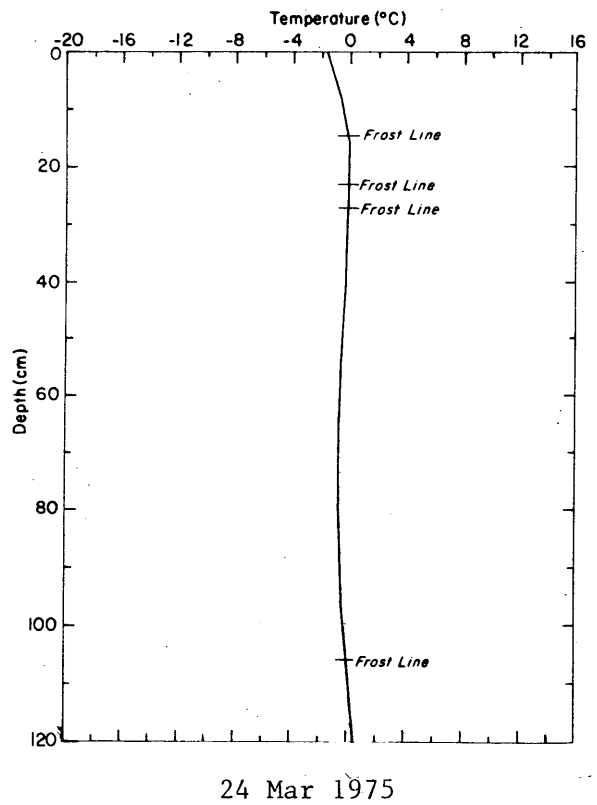
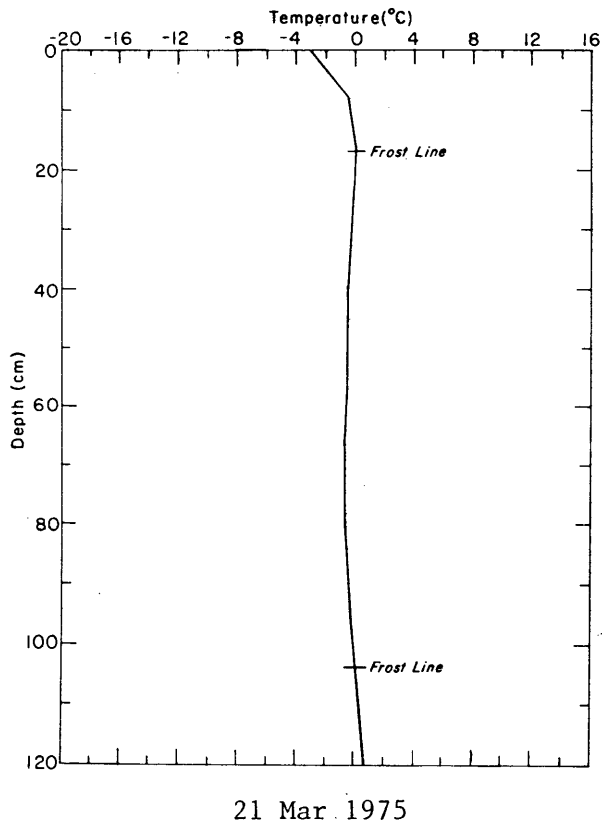
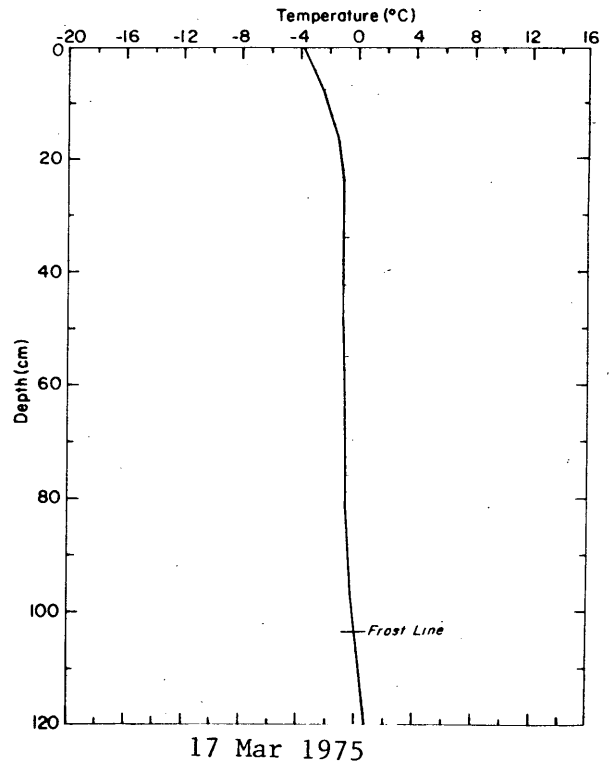
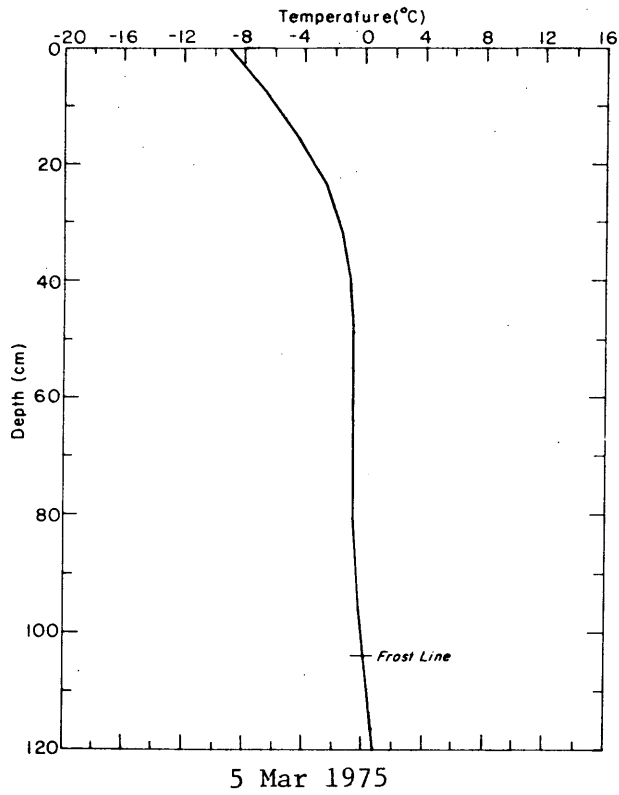

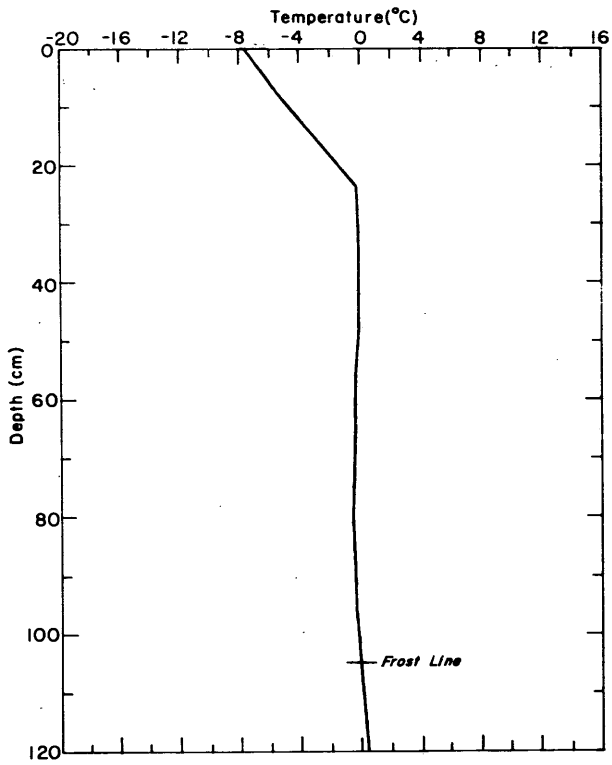

28 Mar 1975

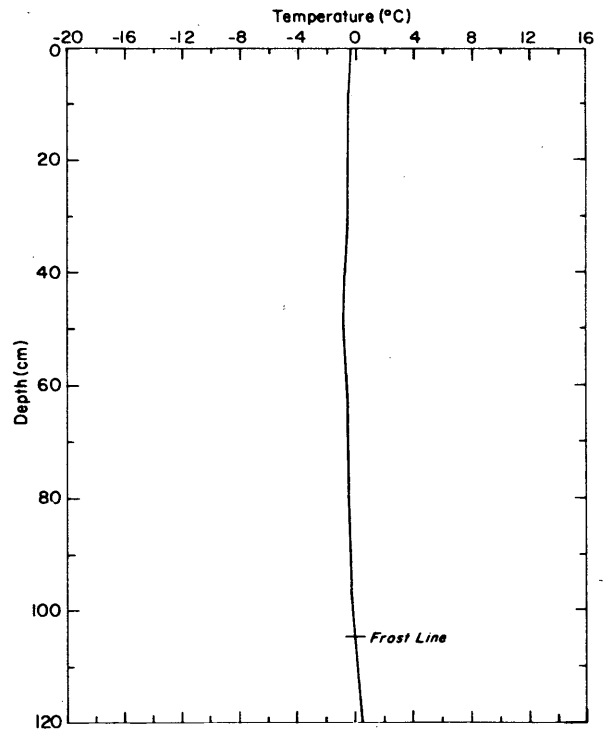

4 April 1975

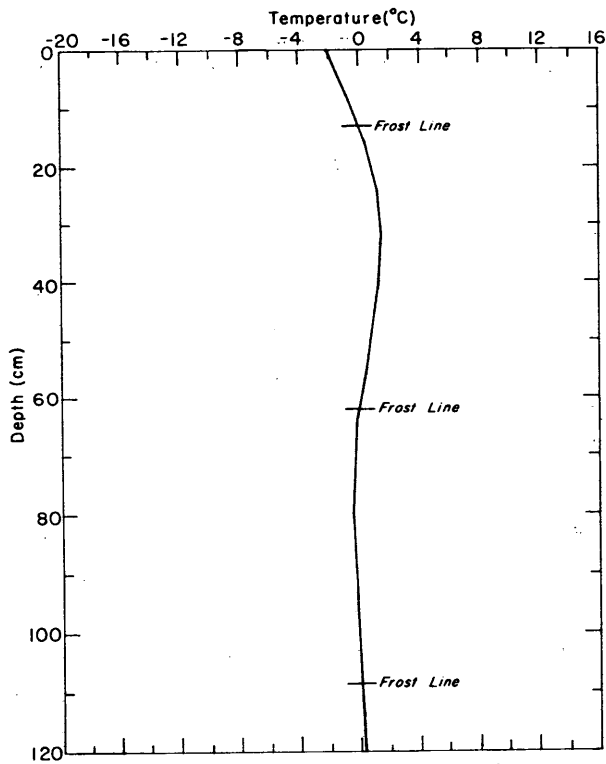

11 April 1975

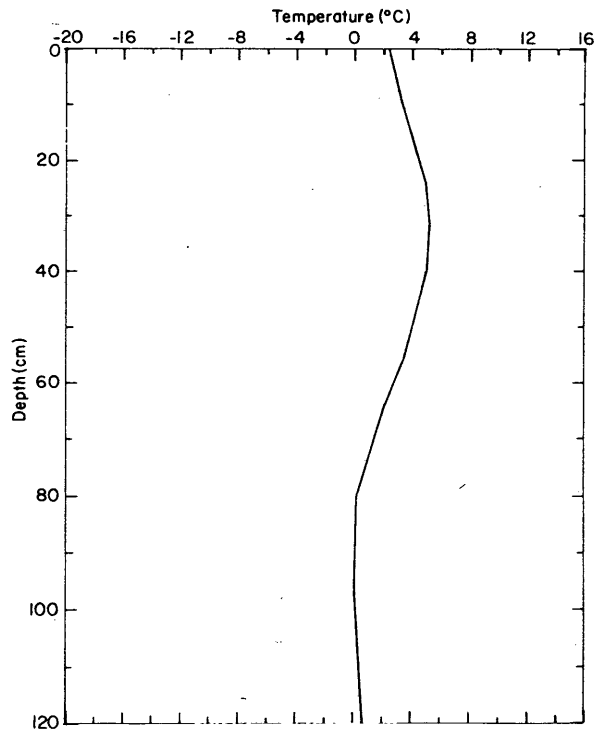

18 April 1975

Appendix C: Thermistor Data

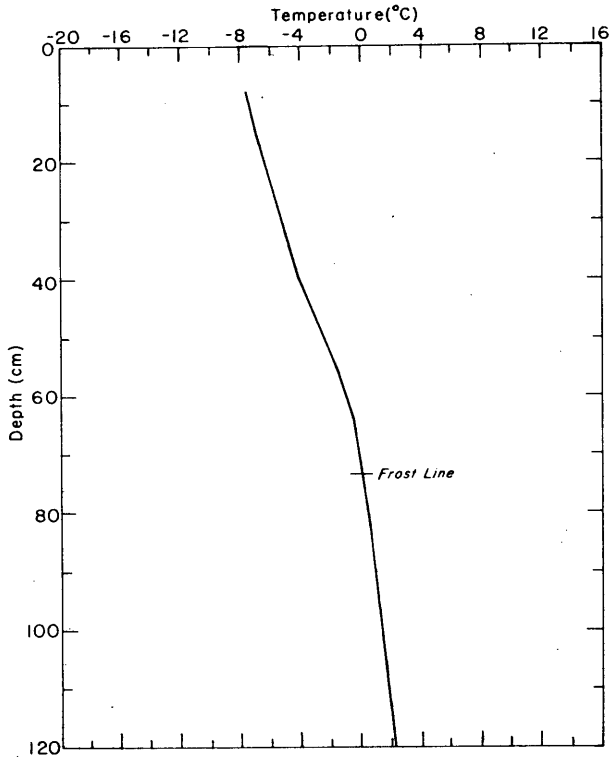

22 Jan 1975

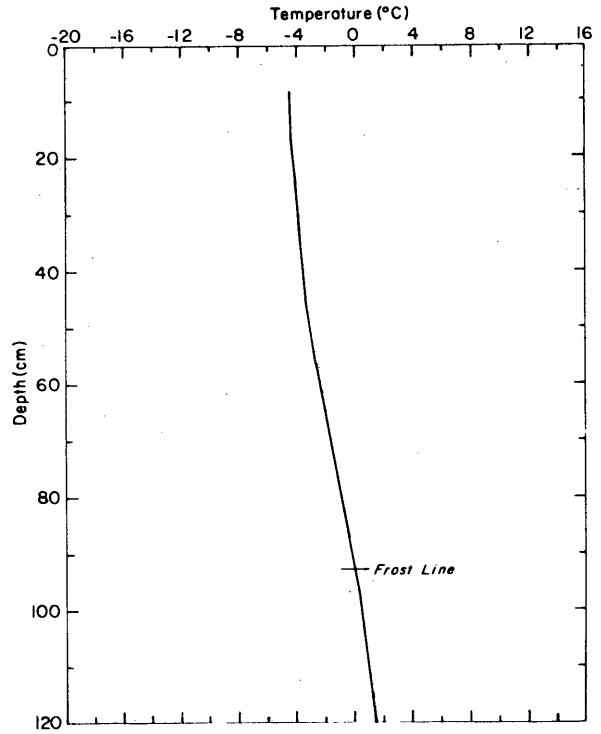

7 Feb 1975

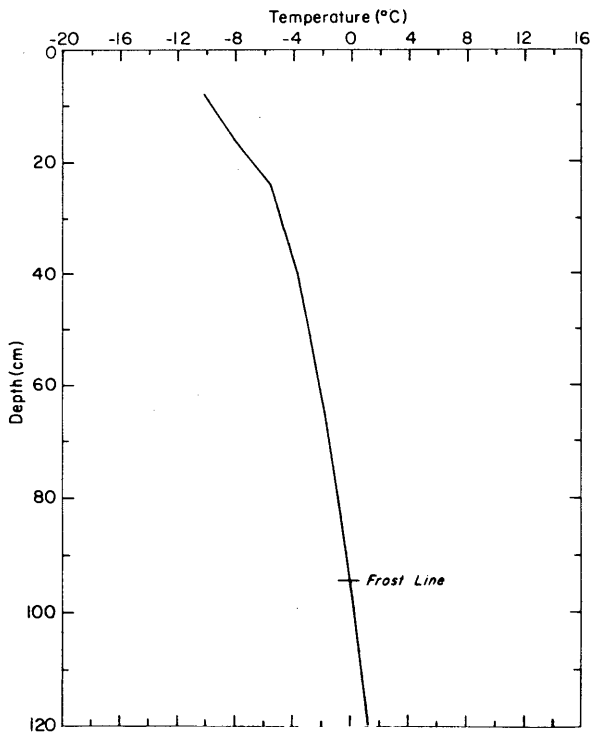

10 Feb 1975

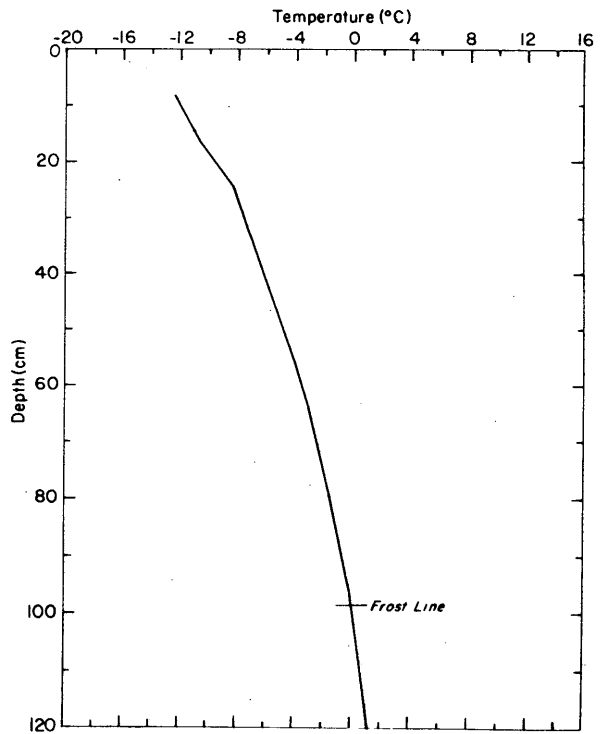

14 Feb 1975

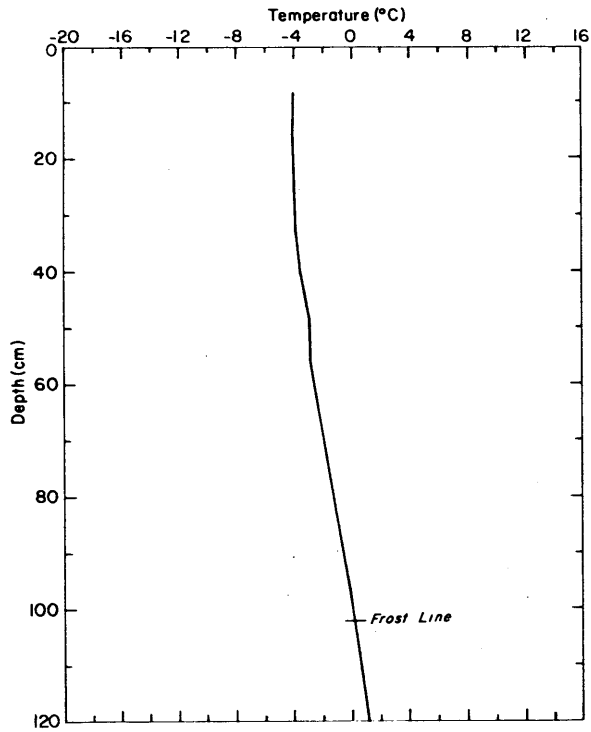

18 Feb 1975

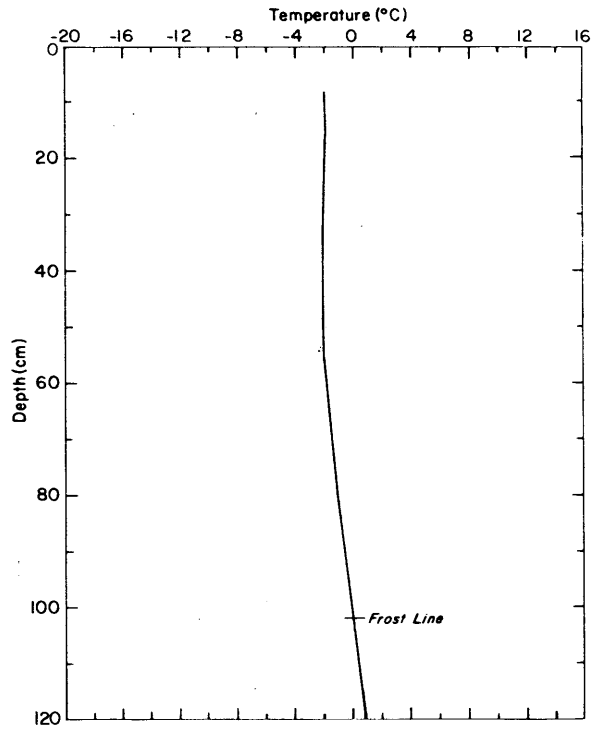

20 Feb 1975

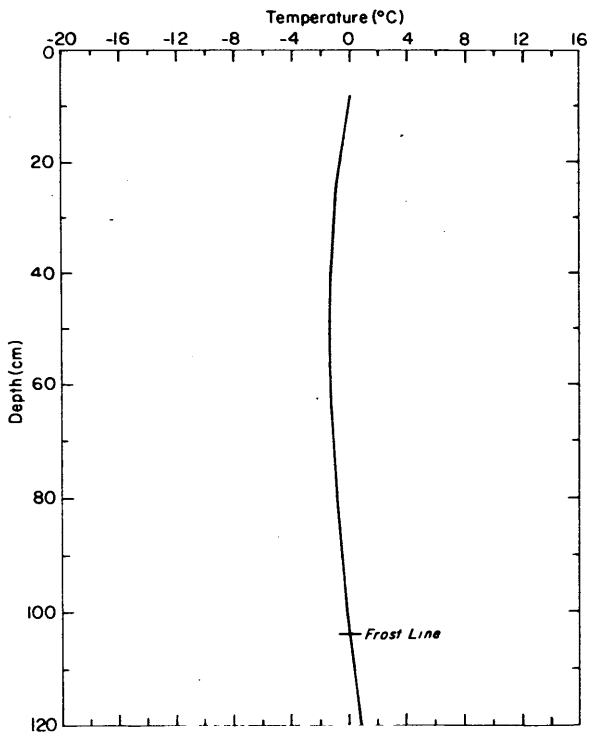

24 Feb 1975

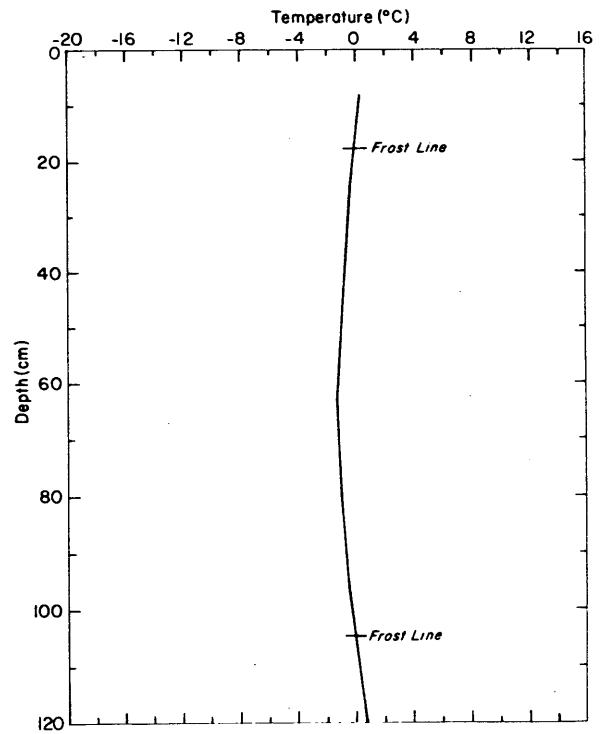

26 Feb 1975



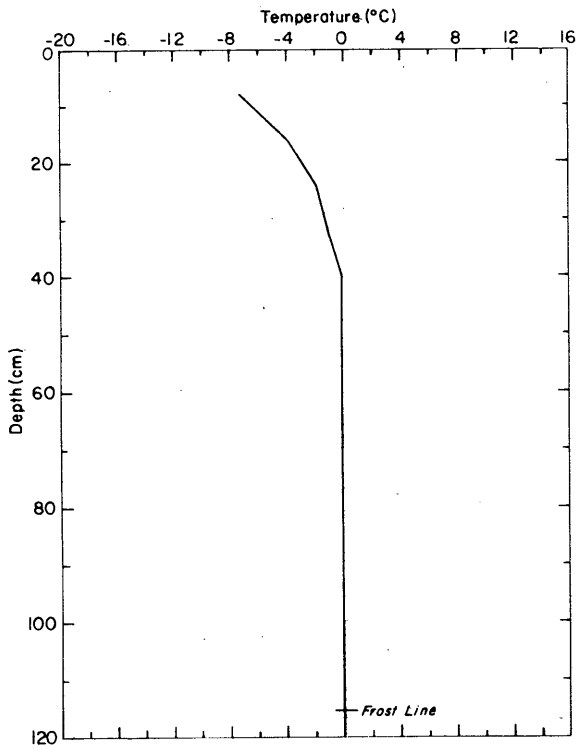

5 Mar 1975

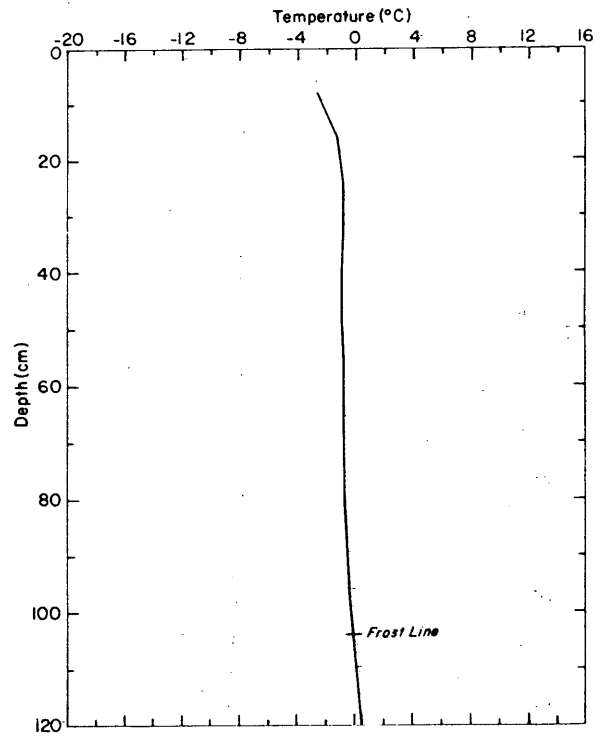

17 Mar 1975

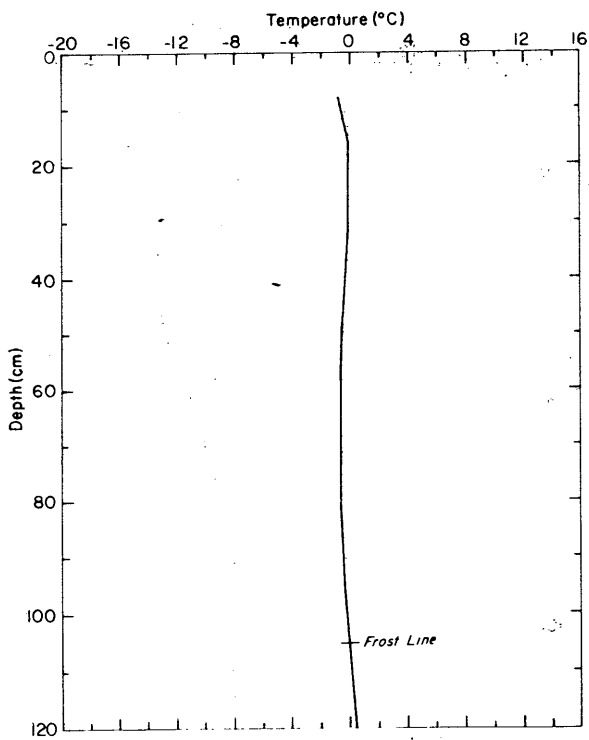

21 Mar 1975

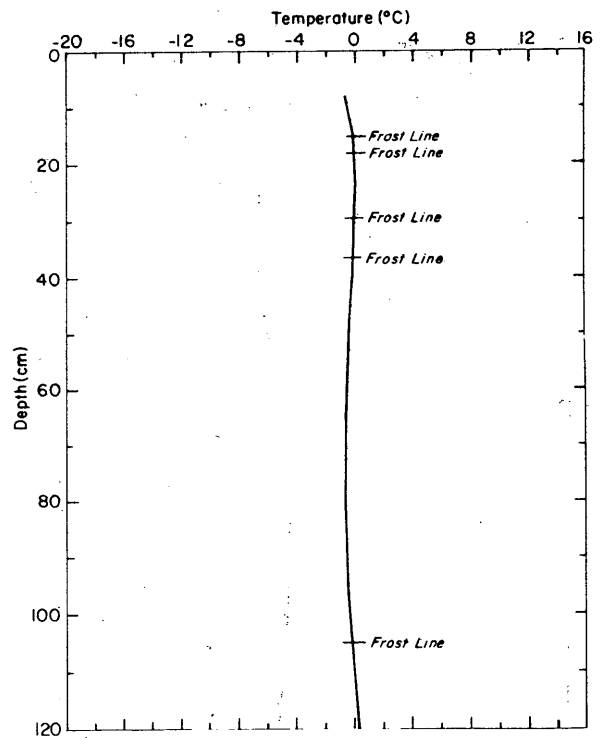

24 Mar 1975

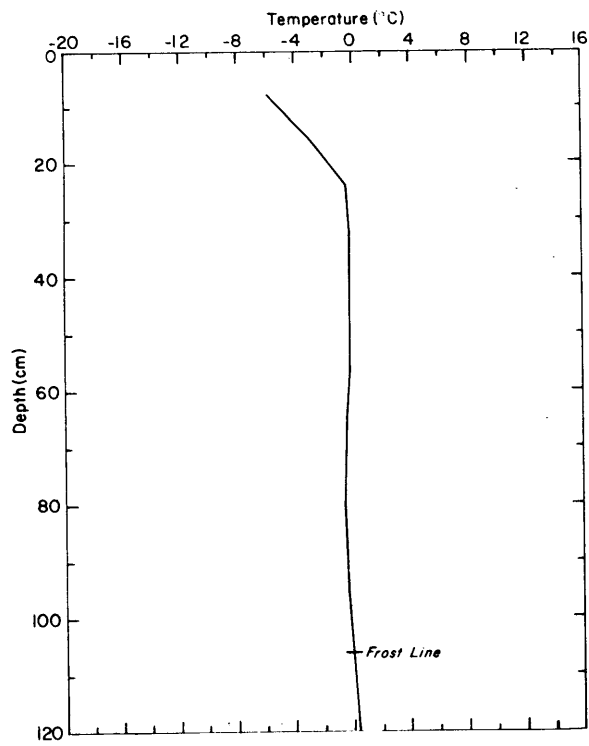

28 Mar 1975

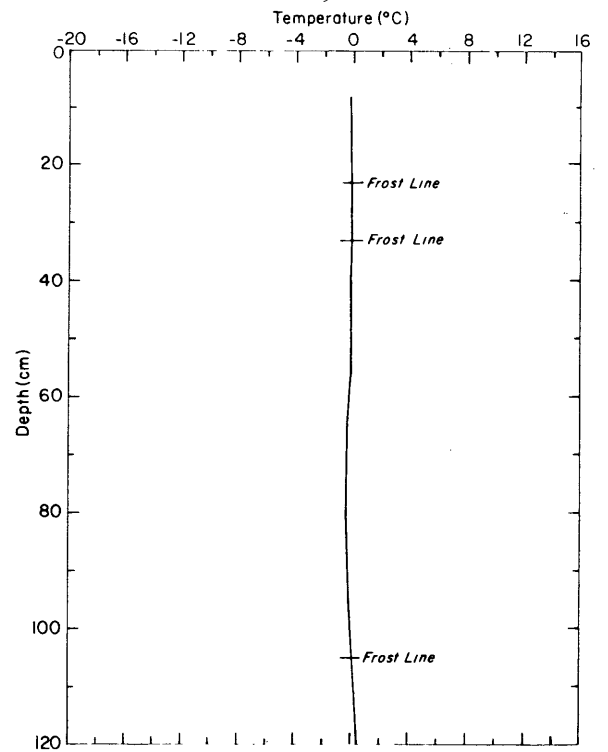

4 April 1975

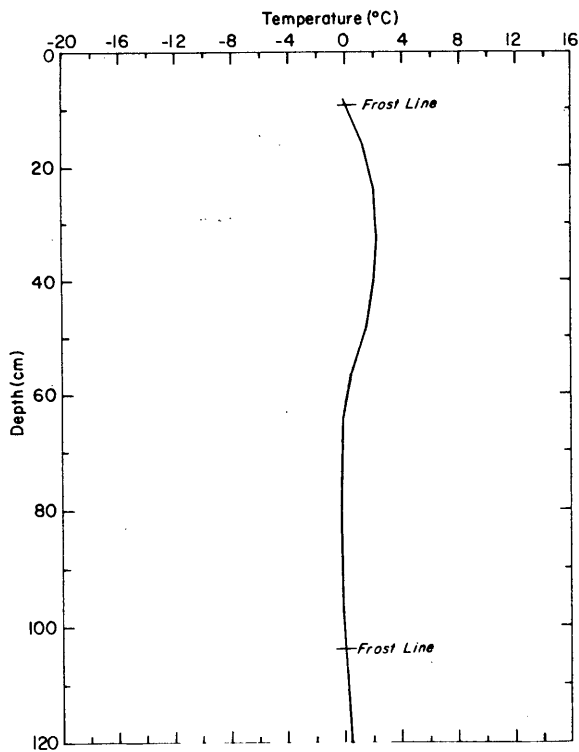

11 April 1975

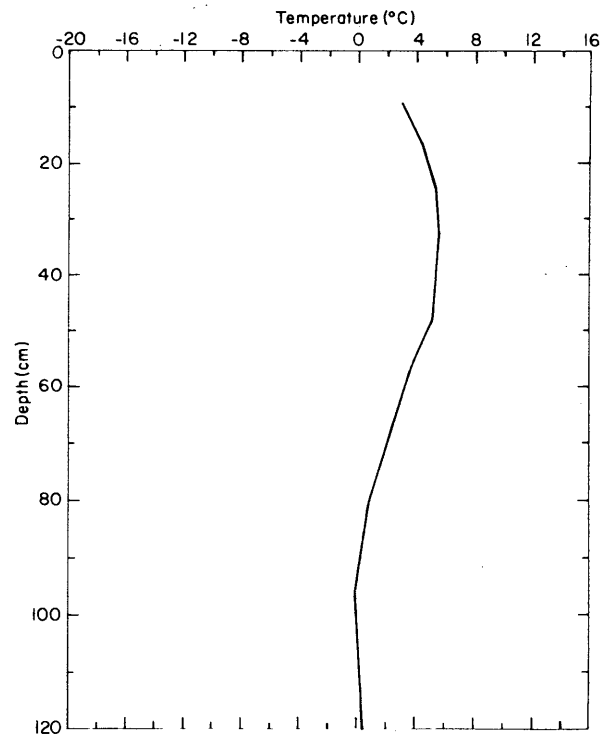

18 April 1975