



The CADD/GIS Technology Center

for facilities, infrastructure, and environment

A/E/C CADD Standard

Main Text and Appendices A, B, and C

Appendix D

The A/E/C CADD Standard is
compliant with Version 2.0
of the U.S. National
CAD Standard.

The A/E/C CADD Standard
contains supplemental materials
and DoD specific requirements
not addressed in the U.S. National
CAD Standard.



Release 2.0

Approved For Public Release; Distribution Is Unlimited

The contents of this report are not to be used for advertising, publication, or promotional purposes. Citation of trade names does not constitute an official endorsement or approval of the use of such commercial products.

The findings of this report are not to be construed as an official Department of the Army position, unless so designated by other authorized documents.



PRINTED ON RECYCLED PAPER

A/E/C CADD Standard

Main Text and Appendices A, B, and C
Appendix D

Release 2.0

Approved for public release; distribution is unlimited

Contents

- Preface viii

- 1 — Introduction 1
 - Acronyms 1
 - Scope 1
 - Purpose 1
 - Background 2
 - International System of Units (SI) Considerations 2
 - Future Technologies 2
 - Interchangeable Terminology 3
 - Target Systems 3
 - Additions/Revisions 3

- 2 — Drawing File Organization 5
 - Design Cube 5
 - Available drawing area 5
 - File accuracy (units) 6
 - Drawing units/working units recommendations 6
 - Origin (global origin) 6
 - Model Files and Sheet Files 7
 - Electronic Drawing File Naming Conventions 8
 - Model file naming convention 8
 - Sheet file naming convention 12
 - Coordination Between Sheet File Name and Sheet Identifier 17

- 3 — Graphic Concepts 19
 - Presentation Graphics 19
 - Line widths 19
 - Line types/styles 20
 - Line color 21
 - Screening 21
 - Text styles/fonts 23
 - Plotting 23
 - Border Sheets 23
 - Sheet sizes 23

Title block	25
Drawing Scales	27
Dimensioning in Metric (SI)	27
Millimeters	27
Meters	31
Large units of measure	31
Dual units	32
4 — Level/Layer Assignments	33
Levels/Layers	33
Level/layer naming conventions	35
ISO format	35
Model Files	35
Level/layer assignment tables	35
Border sheets	37
Reference files (XREFs)	37
Sheet Files	38
Level/layer assignment tables	38
Development of sheet files	39
5 — Standard Symbology	41
Introduction	41
Electronic Version of the Symbology/Elements	41
Deliverables	41
Line styles	41
Tabulated Version of the Symbology/Elements	41
6 — A/E/C CADD Standard Implementation Tools	44
References	47
Appendix A: Model File Level/Layer Assignment Tables	A1
Appendix B: Sheet File Level/Layer Assignment Tables	B1
Appendix C: Color Comparison	C1
Appendix D ¹ : A/E/C CADD Symbology	D1

SF 298

¹ Bound separately.

List of Figures

Figure 1.	Available drawing size	5
Figure 2.	AutoCAD Units Dialog Box	6
Figure 3.	Origins in MicroStation and AutoCAD	7
Figure 4.	Sheet file composition	8
Figure 5.	Model file naming convention	9
Figure 6.	Sheet file naming convention	17
Figure 7.	Typical border sheet title block with sheet identification block	18
Figure 8.	Sample metric drawing sheet with vertical title block	26
Figure 9.	Designer identification block (typ.)	26
Figure 10.	Issue block (typ.)	26
Figure 11.	Management block (typ.)	26
Figure 12.	Project identification block/sheet title block	27
Figure 13.	Sheet identification block	27
Figure 14.	Dimension in millimeters	31
Figure 15.	Dimension in meters	31
Figure 16.	Proper dimension presentations for metric measurements with four or more digits	31
Figure 17.	Unit format	31
Figure 18.	Typical levels/layers contained in a sheet file	33
Figure 19.	Sheet- and model-specific information	34
Figure 20.	Level/layer naming format methods	35
Figure 21.	ISO 13567-2 level/layer naming method	36
Figure 22.	Model file level/layer assignment table	37

Figure 23. Using referenced model files to build a new model file without redundant effort	38
Figure 24. Sheet file level/layer assignment table	39
Figure 25. Using multiple referenced model files to build a sheet file without redundant effort	40
Figure 26. Symbology directory structure	42
Figure 27. Line element	43
Figure 28. Pattern element	43
Figure 29. Symbol element	43
Figure 30. Object element	43
Figure 31. MicroStation workspace	45
Figure 32. Workspace checker	46
Figure 33. AutoCAD workspace	46

List of Tables

Table 1. Interchangeable Terminology	4
Table 2. MicroStation Working Units and Global Origins	7
Table 3. Discipline Designators	9
Table 4. Model File Types	10
Table 5. Discipline Designators with Level 2 Designators	13
Table 6. Sheet Type Designators	17
Table 7. Comparison of Line Widths	19
Table 8. Standard Line Types/Styles	20
Table 9. Screen Color Comparison	21
Table 10. Screened Colors	22

Table 11.	Comparison of Font Types	24
Table 12.	ISO, ANSI, and Architectural Sheet Size Comparison	25
Table 13.	Drawing Scales	28
Table 14.	Inch-pound Text Sizes	29
Table 15.	Metric Text Sizes	30

Preface

The “A/E/C CADD Standard Manual” has been developed by the CADD/GIS Technology Center (CGTC) for Facilities, Infrastructure, and Environment to eliminate redundant Computer-Aided Design and Drafting (CADD) standardization efforts within the Department of Defense (DoD) and the Federal Government. The manual is part of an initiative to consolidate existing CADD drafting standards and to develop data standards that address the entire life cycle of facilities within the DoD. The A/E/C CADD Standard Manual is part of a set of standards being developed by the CGTC. Additional manuals include the following:

- a. Contract Language Guidelines for Acquiring CADD and GIS Deliverables from Architect-Engineer (A-E) Consulting Firms
- b. Spatial Data Standard for Facilities, Infrastructure, and Environment
- c. Facility Management Standard for Facilities, Infrastructure, and Environment

Information on all these documents can be obtained from the CGTC’s web page at <http://tsc.wes.army.mil>.

Chapters 1-6 of this manual address topics such as presentation graphics, level/layer assignments, electronic file naming, and standard symbology. Appendices A-D contain tables on model and sheet file level/layer names, color comparisons, and A/E/C CADD symbology. The CGTC’s primary goal is to develop a nonproprietary CADD standard that

incorporates existing industry, national, and international standards.

Mr. Harold L. Smith is Chief of the CGTC, which is located in the Information Technology Laboratory (ITL), U.S. Army Engineer Research and Development Center, Waterways Experiment Station (WES), Vicksburg, MS. The Acting Director of ITL is Mr. Timothy D. Ables. At the time of publication of this report, the Director of ERDC was Dr. James R. Houston. Commander and Executive Director was COL John W. Morris III, EN.

United States National CAD Standard

In 1995, the combined resources of the CADD/GIS Technology Center, the American Institute of Architects (AIA), the Construction Specifications Institute (CSI), the United States Coast Guard, the Sheet Metal and Air Conditioning Contractors National Association (SMACNA), the General Services Administration (GSA), and the National Institute of Building Sciences’ (NIBS) Facility Information Council began an effort to develop a single CADD standard for the United States. Working together, these organizations agreed to develop an integrated set of documents that collectively would represent the United States National CAD Standard.

The sections of the United States National CAD Standard were developed as follows:

- Layering and model file naming were developed and published by AIA, with assistance from CSI and CGTC.

- Drawing set organization and sheet file naming were developed and published by CSI, assisted by CGTC, and reviewed by AIA.
- Sheet organization was developed and published by CSI, with assistance from AIA and CGTC.
- Schedules were developed and published by CSI, assisted by CGTC, and reviewed by AIA.
- Plotting guidelines (colors and line weights) were developed by CGTC and the United States Coast Guard, and reviewed by CSI and AIA.
- Drafting conventions including notations, symbols, diagrams, scales, and line types were developed by CSI, CGTC, the United States Coast Guard, and SMACNA; assisted by AIA; and published by CSI.
- Nongraphic attributes will be developed and published by CGTC, the International Alliance for Interoperability (IAI), vendors, and trade associations, with review by CSI and AIA.
- “The Uniform Drawing System”
The Construction Specifications Institute
601 Madison Street
Alexandria, VA 22314-1791
<http://www.csinet.org>
- “AIA CAD Layer Guidelines”
The American Institute of Architects Press
1735 New York Avenue, N. W.
Washington, DC 20006
<http://www.aiaonline.com/>

Each of these documents can currently be obtained from the authoring agency or can be purchased together as part of the United States National CAD Standard. Additional information on the United States National CAD Standard can be obtained from

- NIBS Facility Information Council
National Institute of Building Sciences
1090 Vermont Avenue, N. W., Suite 700
Washington, DC 20005-4905
<http://www.nationalcadstandard.org>

A Memorandum of Understanding (MOU) was signed on August 8, 1997. In accordance with that MOU, Release 2.0 of the A/E/C CADD Standard follows, utilizes, or references the work developed by each of the signatories. The two main documents referenced within Release 2.0 of the A/E/C CADD Standard are

The contents of this report are not to be used for advertising, publication, or promotional purposes. Citation of trade names does not constitute an official endorsement or approval of the use of such commercial products.

1 Introduction

Acronyms

First, a few useful acronyms:

- A-E - Architect-Engineer
- A/E/C - Architectural, Engineering, and Construction
- AIA - American Institute of Architects
- ANSI - American National Standards Institute
- ASTM - American Society for Testing and Materials
- CAD - Computer-Aided Design
- CADD - Computer-Aided Design and Drafting
- CGTC - The CADD/GIS Technology Center
- CSI - Construction Specifications Institute
- DoD - Department of Defense
- FM - Facility Management
- GIS - Geographic Information System
- IAI - International Alliance for Interoperability
- IFC - Industry Foundation Class
- IOC - Intelligent Object Class
- ISO - International Organization for Standardization
- NCS - National CAD Standard
- NIBS - National Institute of Building Sciences
- SI - International System of Units (Le Système International d'Unités)
- UDS - Uniform Drawing System

Scope

This manual provides guidance and procedures for preparing Computer-Aided Design and Drafting (CADD) products within the Department of Defense (DoD).

Chapters 1-6 of this manual address topics such as presentation graphics, level/layer assignments, electronic file naming, and standard symbology. Appendices A-D contain tables on model and sheet file level/layer names, color comparisons, as well as Architectural, Engineering, and Construction (A/E/C) CADD symbology.

Purpose

The purpose of this manual is to set a basic CADD standard to ensure consistent electronic deliverables (products) within the DoD. These consistent deliverables are part of a comprehensive installation life-cycle management strategy. This manual sets a CADD standard specifically for the architectural, engineering, and construction disciplines of facilities development and civil works projects. As this manual evolves, it will be integrated with other standards initiatives by the CADD/GIS Technology Center (CGTC) for

Facilities, Infrastructure, and Environment such as Contract Language Guidelines, Spatial Data Standards, and Facility Management (FM) Standards.

Background

The immediate benefits of CADD standards are many: consistent CADD products for customers; uniform requirements for A-E deliverables; sharing of products and expertise; and collection, manipulation, and exchange of database information. Recognizing such potential benefits, each of the DoD agencies independently initiated efforts to establish CADD standards in the late 1980's. The Air Force Logistics Command (1989) released the "Architectural and Engineering Services for CADD Implementation Within Air Force Logistics Command." Headquarters, U.S. Army Corps of Engineers (1990), published Engineer Manual 1110-1-1807, "Standards Manual for U.S. Army Corps of Engineers Computer-Aided Design and Drafting (CADD) Systems." In 1993, the Naval Facilities Engineering Command distributed its "Policy and Procedures for Electronic Deliverables of Facilities Computer-Aided Design and Drafting (CADD) Systems."

To consolidate these efforts into a single standard, the CGTC was tasked to develop standards for the A/E/C disciplines. This manual presents the CGTC's effort at standardizing CADD requirements for A/E/C design and construction documents. To facilitate the use of this standard, supplementary software packages are available that automate the implementation and use of the standard. This software allows the operator to select preset system variables to align with the requirements of the "A/E/C CADD Standard Manual" to ensure consistent and easy compliance with the standard (see Chapter 6, "A/E/C CADD Standard Implementation Tools").

International System of Units (SI) Considerations

For this standard manual, the impact of the SI, more commonly referred to as the metric system, is addressed on such items as drawing scales, sheet sizes, and dimensioning. The SI was established by the General Conference of Weights and Measures of 1960, as interpreted or modified from time to time for the United States by the Secretary of Commerce under the authority of Public Law 94-168, the Metric Conversion Act of 1975, and the Metric Education Act of 1978. As of January 1, 1992, in accordance with Public Laws 94-168 and 100-418, the Omnibus Trade and Competitiveness Act of 1988, and Executive Order 12770, "Metric Usage in Federal Government Programs," July 25, 1991, all new and revised construction standards and criteria must be developed using the SI.

Future Technologies

There are several ongoing initiatives to create a universal language for collaborative work in the area of building and construction software. This work stems from the need to automate current building and construction tasks to become more efficient and cost effective. One of these initiatives is by the International Alliance for Interoperability (IAI), a nonprofit building industry alliance comprising architects, engineers, contractors, software vendors, government agencies, research laboratories, and universities. The goal of the IAI is to unite the A/E/C and FM businesses by specifying Industry Foundation Classes (IFCs) as a universal language. The concept behind the IFCs is to create a series of standard intelligent software objects for the building industry that allow all process disciplines (i.e., architects, designers, engineers, builders, facilities managers) to exchange information. The IAI is developing IFCs that allow current software packages such as AutoCAD and MicroStation to share building and construction data. IFCs would improve the quality of the life-cycle of a building from

construction through maintenance and ultimately to demolition. These improvements would result from reductions in expense and delivery time, enhanced communications, and an increase in discipline proficiency.

A prerequisite of this effort is the deployment of mechanisms capable of retaining knowledge during the project life cycle. Intelligent Object Classes (IOCs) can serve this purpose. An IOC gathers information during the progression of the project and makes it available to the participants. Starting from the design phase, IOCs collect additional data about an object, for example, “how to design” or “how to construct” that particular object. The structure of an IOC contains information about the following:

- Generic attributes of common use (e.g., identification, material).
- Methods to support specialist tasks (e.g., volume calculations).
- CADD representation information including geometry and topology.
- Interrelationships with other objects.

In tandem with the IAI effort, the CGTC is developing nongraphic attribute data as part of the A/E/C CADD Standard.

Interchangeable Terminology

Within the various commercially available CADD systems, many identical or related concepts are given different names. To aid users of this manual, some instances of related or interchangeable terminology used in MicroStation and AutoCAD are listed in Table 1.

Target Systems

This manual is not targeted toward any specific CADD system or software. However, to ensure successful translations among CADD

applications, certain system-specific characteristics were considered and the standard adjusted accordingly. In preparing the standard, several baseline decisions were made:

- The standard must be applicable to the latest release of commercially available CADD packages. AutoCAD and MicroStation were chosen based on their prevalence in the DoD and their availability through the Installation Management/Facilities CAD2 contract.
- The standard is based on CADD applications that utilize layer/level names and reference files.
- The standard requires every final plotted drawing sheet to have its own separate electronic drawing file.
- Since three-dimensional files are not compatible with two-dimensional files, it is recommended that all drawings be created as 3-D files.

Additions/Revisions

This standard is intended to be neither static nor all-inclusive and thus will be updated and enhanced as appropriate. Suggestions for improvements are strongly encouraged so that subsequent updates will reflect the input and needs of CADD users.

Recommendations or suggested additions should be sent to:

The CADD/GIS Technology Center
USAE Research and Development Center,
Waterways Experiment Station
ATTN: CEERD-ID-C/Spangler
3909 Halls Ferry Road
Vicksburg, MS 39180-6199

Or by e-mail at: spangls@wes.army.mil

**Table 1
Interchangeable Terminology**

MicroStation	AutoCAD	Definition
Integer d/b	64-bit floating point d/b	The method for storing drawing attribute data.
Disk-based	Memory-based	Where drawing data are stored until the active file is closed.
Auxiliary Coordinate System (ACS)	User Coordinate System (UCS)	An XYZ coordinate system where the origin is selected by the user.
Active	Current	File or object in use.
Cell	Block	Single or multiple entities grouped together to create a single element.
Dimension attributes	Dimensions styles	Controls the appearance of dimension elements.
.dgn	.dwg	A DOS-based extension for drawing files.
Drop	Explode	Converts an element into multiple entities.
Dynamic update	Dragmode/rubberbanding	Display of element(s) being drawn or modified as pointer/cursor moves on the screen.
Element	Entity	A single object contained in a drawing.
Fit	Zoom all	Displays all graphics currently in the drawing file.
Global origin/design cube	World Coordinate System/Origin	Defines the location(s) of all entities in a design/drawing using the Cartesian coordinate system.
Identify/accept	Select/pick	Entity or entities chosen for manipulation or modification.
Image	Slide	A screen capture of graphics in raster format.
Key entry field	Command prompt	Allows for keyboard input from users.
Key point snap	Object snap (Osnap)	Controls the selection location for entities.
Levels	Layers	Used as transparent overlays for display graphics.
Line style	Linetype	Defines the appearance of lines.
Linestring	Polyline	Connected line segments.
Locate tolerance	Pickbox	Identification/selection limits for the drawing cursor.
MDL/Visual BASIC	ARX/AutoLISP	System-specific command language.
Message field	Status line	Displays current drawing status and/or text output from the application.
Monument point	Insertion point	Benchmark point used to place objects in a drawing.
Move element	Move	Relocation of entities.
Patterning	Hatching	To fill an area within a drawing with a symbolic texture.
Precision key in	Coordinate entry	User-defined XYZ values.
Reference file	External reference	A design/drawing file attached to an active drawing.
Seed file	Prototype drawing	A drawing design template file.
Tentative/Data point	Pointing/pick point	A point within the drawing selected using a pointing device.
Update	Redraw/Regenerate	Refreshes screen display.

2 Drawing File Organization

Design Cube

Available drawing area

The two most extensively used CADD applications within the DoD, AutoCAD and MicroStation, manage the available drawing area in an electronic file differently. MicroStation has a limited drawing area (design cube) composed of individual points that restrict the physical size of any drawing (Figure 1).

MicroStation's design cube has 4,294,967,296 points in each axis (x,y,z) of the design cube. These points are called positional units (PU). Positional units are grouped into larger units called subunits (SU), and subunits are grouped into even larger units called master units (MU). Together, these groups are called working units (MU:SU:PU). These groups will be discussed in more detail in the next section.

By defining the values of working units, the MicroStation user defines the measurable limits of the design cube. For example, the working units for most architectural drawings (feet-inches) are 1:12:8000 (MU = feet, SU = inches). With these working units, a design cube of 44,739 feet per side is created:

$$4,294,967,296 \div (12 \text{ in./ft} \times 8000) = 44,739 \text{ ft}$$

For an SI (metric) drawing with working units of 1:1:100 (MU = millimeters, SU = none), the design cube has a length of 42,949,672 millimeters per side.

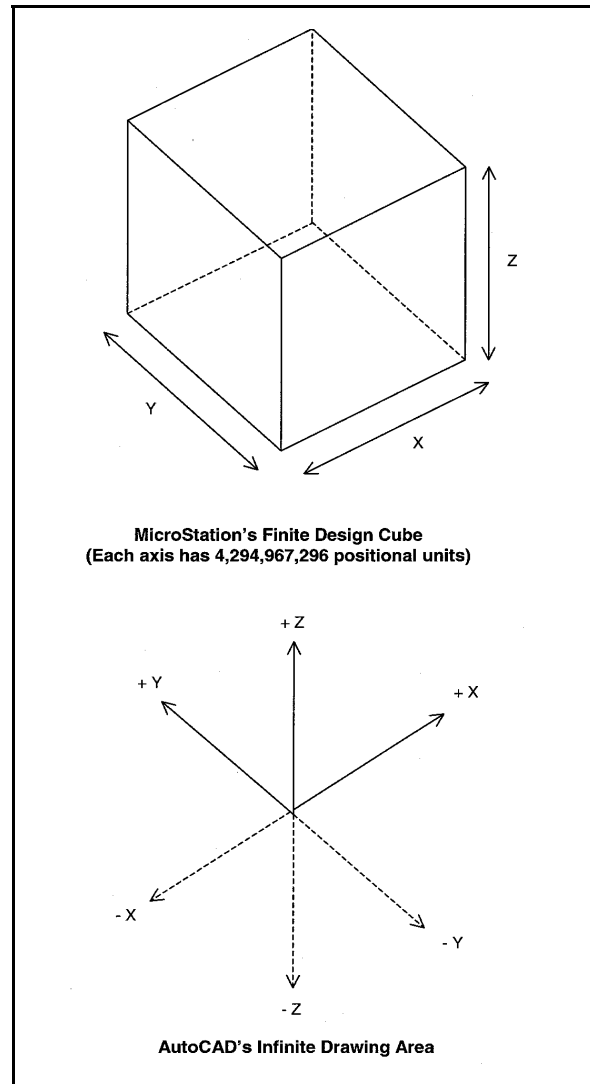

Figure 1. Available drawing size

$$4,294,967,296 \div (1 \text{ mm} \times 100) = 42,949,672 \text{ mm}$$

In contrast, AutoCAD’s approach provides for a drawing area with infinite range in each positive and negative axis (x,y,z).

Note: *The upcoming MicroStation V8 will also allow for an infinite drawing area.*

File accuracy (units)

CADD systems allow the designer to work in “real world” units. The most common units are feet and inches, feet and tenths of feet, meters, and millimeters.

MicroStation’s approach to file accuracy allows the user to set the working units (i.e., real world units) as the following, introduced in the previous section:

- Master units (MU) = The largest unit that may be referred to when working in the design file (e.g., feet, meters).
- Subunits (SU) = Subdivisions of master units in the working unit definition (e.g., inches, millimeters).
- Positional units (PU) = The smallest unit that may be addressed in the design file. The number of positional units per subunit determines the precision of the drawing and the size of the design cube.

In AutoCAD, the basic drawing unit for any file is the distance between two fixed Cartesian coordinates. For example, the distance between coordinates (1,1,1) and (1,1,2) is one drawing unit. A drawing unit can correspond to any measurement (e.g., inch, foot, meter, mile). AutoCAD users may enter the “Units” display option to set the desired drawing units.

The “Units” command of AutoCAD does not have a direct metric system setup. For metric designs, the recommended procedure is to choose the “Decimal” option in the drawing units dialogue box (Figure 2). This will allow

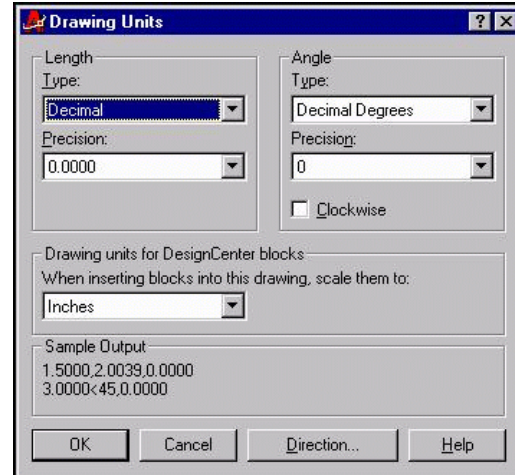

Figure 2. AutoCAD Units Dialog Box

each drawing unit to represent decimal meters, millimeters, etc., at the discretion of the user.

Drawing units/working units recommendations

Recommendations for working units in MicroStation design files are shown in Table 2.

AutoCAD users should choose either the architectural (feet and inches), engineering (feet and tenths), or decimal (suitable for meters or millimeters) options as provided in the “Units” command screen.

Origin (global origin)

Positioned within every electronic drawing file is an origin (“global origin” in MicroStation and “origin” in AutoCAD). The origin of a drawing file is important because it serves as the point of reference from which all other elements are located. Origins are typically defined (located) in a drawing file by the Cartesian coordinate system of x, y, and z (Figure 3).

Table 2 MicroStation Working Units and Global Origins					
Units	MU	SU	PU	Design Cube Size	Recommended Global Origin
Inch-pound (A/E/C)	1 (ft)	12 (in)	8000	44,739 ft/side	GO=22369.6213, 22369.6213, 22369.6213
Inch-pound (Civil, Civil Works, Geotechnical, Survey/Mapping)	1 (ft)	100	10	4,294,967 ft/side	GO=0, 0, 2147483.648
Metric (A/E/C)	1 (mm)	1	100	42,949,672 mm/side	GO=21474836.48, 21474836.48, 21474836.48
Metric (Civil, Civil Works, Geotechnical, Survey/Mapping)	1 (m)	1000	1	4,294,967 m/side	GO=0, 0, 2147483.648
Metric (Mechanical Machine Design)	1 (mm)	1000	1	4,294,967 mm/side	GO=2147483.648, 2147483.648, 2147483.648

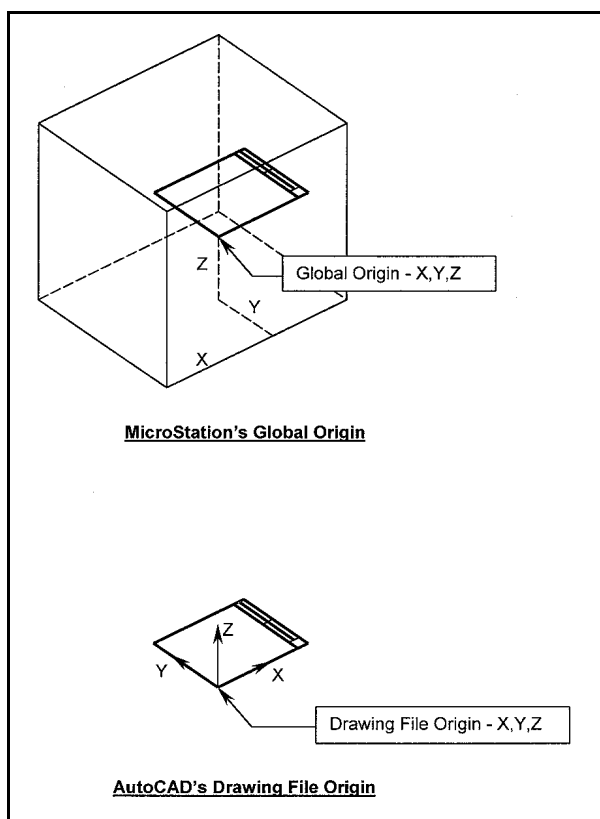

Figure 3. Origins in MicroStation and AutoCAD

The benefit of standardizing the location of the origin of a drawing is most notable in the use of reference files (see section “Reference Files (XREFs)” in Chapter 4). Also, in certain disciplines, particularly mapping, the location of the origin determines the available drawing area (MicroStation only). A standardized origin is also helpful when translating files between CADD applications. Origin recommendations are given in Table 2 (Note: for AutoCAD users the recommended global origin will be 0,0,0).

Note: In MicroStation, the location of the global origin does not affect the size of the design cube, but does limit the range of the positive and negative x , y , and z positional units. For example, a design file with the global origin located in the center of the design cube limits the number of positional units in each axis (x , y , and z) to 2,147,483,648.

Model Files and Sheet Files

Two distinct types of CADD files are addressed in this standard: model files and sheet files.

A model file contains the physical components of a building (e.g., columns, walls, windows, ductwork, piping, etc.). Model files are drawn at full scale and typically represent plans, elevations, sections, etc.

A sheet file is synonymous with a plotted CADD drawing file. A sheet file is a selected view or portion of the model file(s) within a border sheet. Sheet files are usually plotted at a particular scale, since the border sheet is scaled up to fit around the full scale model files. In other words, a sheet file is a “ready-to-plot” CADD file.

Figure 4 illustrates how different model files are referenced to a sheet file (notice that the border sheet is always a referenced model file). A sheet file is the combination of referenced model files with sheet-specific text/symbols to create a final “ready-to-plot” CADD file. A useful American Institute of Architects (AIA) rule of thumb states: “Model files are always referenced by other files, while sheet files are never referenced by other files.” See Chapter 4 for additional information.

Electronic Drawing File Naming Conventions

Naming conventions for electronic drawing files (both model files and sheet files) allow CADD users to determine the contents of a drawing without actually displaying the file. They also provide a convenient and clear structure for organizing drawing files within project directories.

Model file naming convention

The model file naming convention (Figure 5) has one optional field, followed by three mandatory fields. While the first field is optional and may be omitted, the remaining fields must be used and in the correct sequence.

The first field is entirely optional and can be used for a 0 to 20-character *Project Code*. Project codes are developed by the user or the system administrator and are not standardized within this document. The use of Project Codes in file names is highly recommended, because it prevents the same file name from existing in different directories. Following the optional

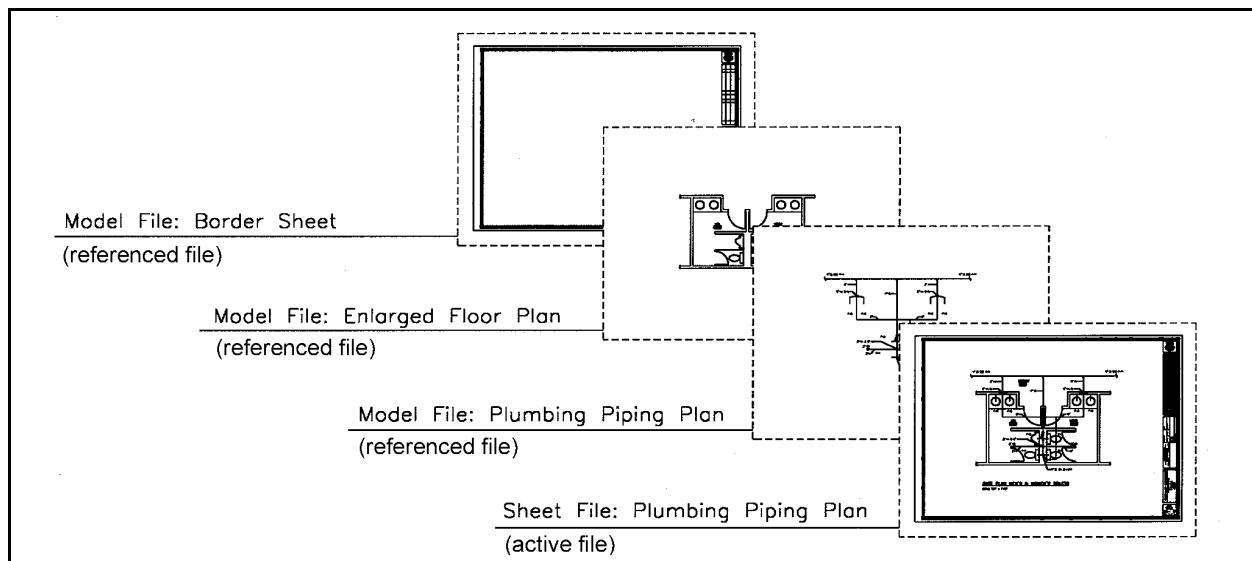

Figure 4. Sheet file composition

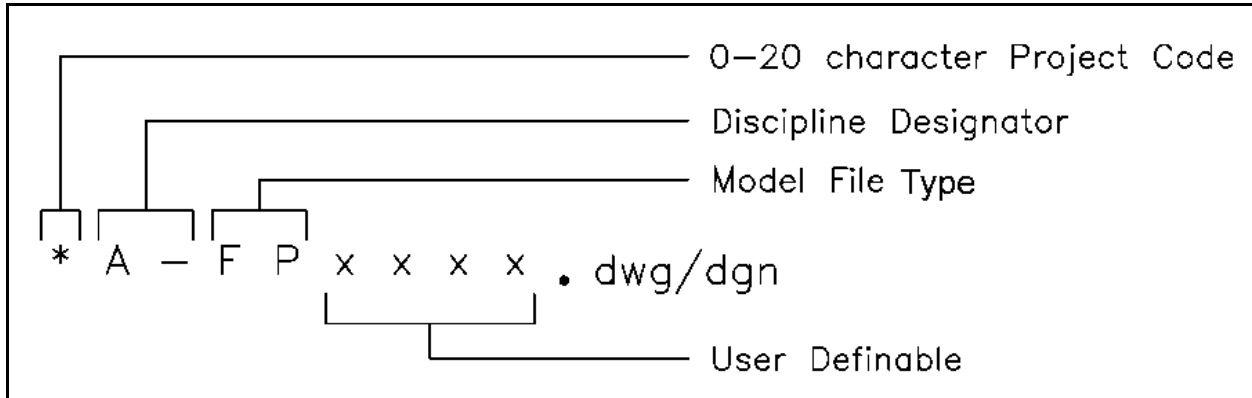

Figure 5. Model file naming convention

Project Code, the first two-character field represents the *Discipline Designator*. The allowable characters for the first character in the Discipline Designator are listed in Table 3. The second character of the Discipline Designator field is always a hyphen “-”. The next two-character field represents the *Model File Type* (Table 4). The final four-character field is user-definable.

Note: *If the Workspace and Checker are being implemented, all eight of the mandatory characters in the model file name must be used and in the correct sequence. If all of the User Definable characters are not needed, placeholders must be used for the Workspace to function properly.*

Example: The model file name for a project at Engineer Research and Development Center (ERDC), Building 8000, 1st floor, Architectural Floor Plan could be:

ERDC8000A-FPF1XX.dgn/dwg

where ERDC8000 is the Project Code, A- is the Discipline Designator, FP is the Model File Type (Floor Plan), and F1 is a user-definable set of characters for Floor 1. Since all the user definable characters were not used, the characters XX were used as placeholders.

Table 3 Discipline Designators	
Discipline	Designator
General	G
Hazardous Materials	H
Survey/Mapping	V
Geotechnical	B
Civil Works	W
Civil	C
Landscape	L
Structural	S
Architectural	A
Interiors	I
Equipment	Q
Fire Protection	F
Plumbing	P
Process	D
Mechanical	M
Electrical	E
Telecommunications	T
Resource	R
Other Disciplines	X
Contractor/Shop Drawings	Z
Operations	O

Existing/Demolition model file naming. There are instances when a facility is being renovated and the as-built designs need to be revised to show demolition and new items.

Table 4 Model File Types		
Discipline	Code	Definition
<i>General</i>		
	BS*	Border Sheet
	KP*	Keyplan
<i>Hazardous Materials</i>		
	DT	Detail
	EL	Elevation
	LG*	Legend
	PP*	Pollution Prevention Plan
	SC	Section
	XD*	Existing/Demolition Plan
<i>Survey/Mapping</i>		
	AL*	Existing Airfield Lighting Plan
	CP*	Existing Communication Plan
	EU*	Existing Electrical Utilities Plan
	FU*	Existing Liquid Fuel Utilities Plan
	HP*	Hydrographic Survey Plan
	HT*	Existing HTCW Utilities Plan
	IW*	Existing Industrial Waste Water Plan
	LG*	Legend
	NG*	Existing Natural Gas Utilities Plan
	PB*	Project Boundary
	PR*	Existing Profile
	SC	Existing Section
	SP*	Survey and Mapping Plan
	SS*	Existing Sanitary Sewer Plan
	ST*	Existing Storm Sewer Plan
	WA*	Existing Domestic Water Plan
<i>Geotechnical</i>		
	BL*	Boring Location Plan
	LB*	Boring Log
	LG*	Legend
	SH	Schedule
<i>Civil</i>		
	AF*	Airfield Plan
	AM*	Airfield Pavement Marking Plan
	CP*	Channel Plan
	DT	Detail
	EC*	Erosion Control Plan

Table 4 (Continued)		
Discipline	Code	Definition
<i>Civil (Continued)</i>		
	EL	Elevation
	FU*	Liquid Fuel Utilities Plan
	GP*	Grading Plan
	IP*	Installation Plan/Base Map
	IW*	Industrial Waste Water Plan
	JP*	Joint Layout Plan
	KP*	Staking Plan
	LG*	Legend
	NG*	Natural Gas Utilities Plan
	PL*	Project Location Map
	PR*	Profile
	SC	Section
	SH	Schedule
	SP	Site Plan
	SS*	Sanitary Sewer Plan
	ST*	Storm Sewer Plan
	TS*	Transportation Site Plan
	WA*	Domestic Water Plan
	XD*	Existing/Demolition Plan
<i>Landscape</i>		
	DT	Detail
	EL	Elevation
	IP*	Irrigation Plan
	LG*	Legend
	LP*	Landscape Plan
	SC	Section
	SH	Schedule
	XD*	Existing/Demolition Plan
<i>Structural</i>		
	3D	Isometric/3D
	CP*	Column Plan
	DT	Detail
	EL	Elevation
	EP*	Enlarged Plan
	FP*	Framing Plan
	LG*	Legend
	NB*	Non-Building Structures Plan
	NP*	Foundation Plan

Table 4 (Continued)		
Discipline	Code	Definition
<i>Structural (Continued)</i>		
	SC	Section
	SH	Schedule
	XD*	Existing/Demolition Plan
<i>Architectural</i>		
	3D	Isometric/3D
	AC*	Area Calculations/Occupancy Plan
	CP*	Reflected Ceiling Plan
	DT	Detail
	EL	Elevation
	EP*	Enlarged Plan
	FP	Floor Plan
	LG*	Legend
	QP	Equipment Plan
	RP*	Roof Plan
	SC	Section
	SH	Schedule
	XD*	Existing/Demolition Plan
<i>Interiors</i>		
	3D	Isometric/3D
	DT	Detail
	EL	Elevation
	EP*	Enlarged Plan
	LG*	Legend
	QP	Equipment Plan
	RP*	Furniture Plan
	SC	Section
	SH	Schedule
	SP*	Signage Placement Plan
	WP*	System/Prewired Workstation Plan
	XD*	Existing/Demolition Plan
<i>Fire Protection</i>		
	DG	Diagram
	DT	Detail
	FA*	Fire Alarm/Detection Plan
	FP*	Fire Suppression Plan
	LG*	Legend

Table 4 (Continued)		
Discipline	Code	Definition
	LP*	Life Safety Plan
	SH	Schedule
	XD*	Existing/Demolition Plan
<i>Plumbing</i>		
	DG	Diagram
	DT	Detail
	EL	Elevation
	EP*	Enlarged Plan
	LG*	Legend
	PP*	Piping Plan
	SH	Schedule
	XD*	Existing/Demolition Plan
<i>Mechanical</i>		
	3D	Isometric/3D
	DG	Diagram
	DT	Detail
	EL	Elevation
	EP*	Enlarged Plan
	HP*	HVAC Plan
	HT*	HTCW Utilities Plan
	LG*	Legend
	MD*	Machine Design Plan
	MH*	Material Handling Plan
	PP*	Piping Plan
	QP	Equipment Plan
	SC	Section
	SH	Schedule
	SP*	Specialty Piping Plan
	XD*	Existing/Demolition Plan
<i>Electrical</i>		
	AL*	Airfield Lighting Plan
	AP*	Auxiliary Power Plan
	CP*	Exterior Communication Systems Plan
	DG	Diagram
	DT	Detail
	EU*	Electrical Utilities Plan
	GP*	Grounding System Plan
	LG*	Legend

Table 4 (Concluded)		
Discipline	Code	Definition
<i>Electrical (Continued)</i>		
	LP*	Lighting Plan
	PP*	Power Plan
	SH	Schedule
	SS*	Special Systems Plan
	XD*	Existing/Demolition Plan
<i>Telecommunications</i>		
	DG	Diagram
	DT	Detail
	LG*	Legend
	SH	Schedule
	TP*	Telephone/Data Plan
	XD*	Existing/Demolition Plan
* = Not in NCS 2.0		

These revisions would not be made on existing as-built model files, but on copies to ensure the original as-builts are not modified.

A new model file type, Existing/Demolition (XD*, where * means this type is not in NCS 2.0), has been added to the standard to allow users to make revisions to as-built files. This model file type is used to aid users in separating existing to remain items from items that will be demolished (for more information on the demolition levels/layers, see Chapter 4, “Demolition levels/layers”).

Example: An Architect has an existing as-built Floor Plan model file for Building 1000, 2nd floor. For the current project, walls will be demolished and new walls constructed on the 2nd floor. First, a copy would be made of the original as-built file (B1000A-FPF2XX.dgn/dwg), which would be renamed to B1000RENA-XDF2XX.dgn/dwg (B1000REN is the Project Code, A- is the Discipline Designator, XD is the Model File Type (Existing/Demolition), and F2XX are user definable characters (F2=Floor 2)). The architect would open this file and move all demolition items to the first demolition

level/layer at that level/layer's correct symbology (if phased demolition is involved, the other levels/layers would be used). When the new items are drawn, the architect would open a new model file called something like

B1000RENA-FPF2XX.dgn/dwg

(B1000REN is the Project Code, A- is the Discipline Designator, FP is the Model File Type (Floor Plan), and F2XX are user definable characters (F2=Floor 2)). The file

B1000RENA-XDF2XX.dgn/dwg

would be referenced in with the Demolition levels/layers turned off. The architect would then use the Floor Plan active levels/layers to construct the new items for that project.

Sheet file naming convention

The sheet file naming convention (Figure 6) has one optional field, followed by four mandatory fields. Similar to the format for model file naming, the first field is optional, while the remaining fields must be used and in the correct sequence.

The first field is entirely optional and can be used for a 0 to 20-character *Project Code* (see "Model File naming convention"). The next two characters are the *Discipline Designator with Level 2 Designator* (see Table 5). The next character is the *Sheet Type Designator* (see Table 6) followed by a two-character *Sheet Sequence Number* (01-99). The remaining three characters are user-definable.

**Table 5
Discipline Designators with Level 2 Designators**

Discipline	Designator	Description	Content
General			
	G-	All General	All or any portion of subjects in the following Level 2 Designators
	GI	General Informational	Drawing index, code summary, symbol legend, orientation maps
	GC	General Contractual	Phasing, schedules, contractor staging areas, fencing, haul routes, erosion control, temporary and special requirements
	GR	General Resource	Photographs, soil borings
Hazardous Materials			
	H-	All Hazardous Materials	All or any portion of subjects in the following Level 2 Designators
	HA	Asbestos	Asbestos abatement, identification, or containment
	HC	Chemicals	Toxic chemicals handling, removal or storage
	HL	Lead	Lead piping or paint removal
	HP	PCB	PCB containment and removal
	HR	Refrigerants	Ozone depleting refrigerants
Survey/Mapping			
	V-	All Survey/Mapping	All or any portion of subjects in the following Level 2 Designators
	VA	Aerial Survey	
	VF	Field Survey	
	VH*	Hydrographic Survey	
	VI	Digital Survey	
	VU	Combined Utilities	
Geotechnical			
	B-	All Geotechnical	
Civil Works			
	W-	All Civil Works	
Civil			
	C-	All Civil	All or any portion of subjects in the following Level 2 Designators
	CD	Civil Demolition	Structure removal and site clearing
	CS	Civil Site	Plats, dimension control
	CG	Civil Grading	Excavation, grading , drainage, erosion control
	CP	Civil Paving	Roads, driveways, parking lots
	CI	Civil Improvements	Pavers, flagstone, exterior tile, furnishings, retaining walls, and water features
	CT	Civil Transportation	Waterways, wharves, docks, trams, railways, airfields, and people movers
	CU	Civil Utilities	Water, sanitary sewer, storm sewer, power, communications, fiber optic, telephone, cable television, natural gas, and steam systems

Table 5 (Continued)

Discipline	Designator	Description	Content
Landscape			
	L-	All Landscape	All or any portion of subjects in the following Level 2 Designators
	LD	Landscape Demolition	Protection and removal of existing landscaping
	LI	Landscape Irrigation	
	LP	Landscape Planting	
Structural			
	S-	All Structural	All or any portion of subjects in the following Level 2 Designators
	SD	Structural Demolition	Protection and removal
	SS	Structural Site	
	SB	Structural Substructure	Foundations, piers, slabs, and retaining walls
	SF	Structural Framing	Floors and roofs
Architectural			
	A-	All Architectural	All or any portion of subjects in the following Level 2 Designators
	AD	Architectural Demolition	Protection and removal
	AS	Architectural Site	
	AE	Architectural Elements	General architectural
	AI	Architectural Interiors	
	AF	Architectural Finishes	
	AG	Architectural Graphics	
Interiors			
	I-	All Interiors	All or any portion of subjects in the following Level 2 Designators
	ID	Interior Demolition	
	IN	Interior Design	
	IF	Interior Furnishings	
	IG	Interior Graphics	Murals and visuals
Equipment			
	Q-	All Equipment	All or any portion of subjects in the following Level 2 Designators
	QA	Athletic Equipment	Gymnasium, exercise, aquatic, and recreational
	QB	Bank Equipment	Vaults, teller units, ATMs, drive-through
	QC	Dry Cleaning Equipment	Washers, dryers, ironing, and dry cleaning
	QD	Detention Equipment	Prisons and jails
	QE	Educational Equipment	Chalkboards, library
	QF	Food Service Equipment	Kitchen, bar, service, storage, and processing
	QH	Hospital Equipment	Medical, exam, and treatment
	QL	Laboratory Equipment	Science labs, planetariums, observatories
	QM	Maintenance Equipment	Housekeeping, window washing, and vehicle servicing
	QP	Parking Lot Equipment	Gates, ticket, and card access

Table 5 (Continued)

Discipline	Designator	Description	Content
Equipment (Continued)			
	QR	Retail Equipment	Display, vending, and cash register
	QS	Site Equipment	Bicycle racks, benches, playgrounds
	QT	Theatrical Equipment	Stage, movie, rigging systems
	QV	Video/Photographic Equipment	Television, darkroom, and studio
	QY	Security Equipment	Access control and monitoring, surveillance
Fire Protection			
	F-	All Fire Protection	All or any portion of subjects in the following Level 2 Designators
	FA	Fire Detection and Alarm	
	FX	Fire Suppression	Fire extinguishing systems and equipment
Plumbing			
	P-	All Plumbing	All or any portion of subjects in the following Level 2 Designators
	PD	Plumbing Demolition	Protection, termination, and removal
	PS	Plumbing Site	Extensions and connections to Civil Utilities
	PP	Plumbing Piping	Piping, valves, and insulation
	PQ	Plumbing Equipment	Pumps and tanks
Process			
	D-	All Process	All or any portion of subjects in the following Level 2 Designators
	DD	Process Demolition	Protection, termination, and removal
	DS	Process Site	Extension and connection to civil utilities
	DL	Process Liquids	Liquid process systems
	DG	Process Gases	Gaseous process systems
	DP	Process Piping	Piping, valves, insulation, tanks pumps, etc.
	DQ	Process Equipment	Systems and equipment for thermal, electrical, materials handling, assembly and manufacturing, nuclear, power generation, chemical, refrigeration, and industrial processes
	DE	Process Electrical	Electrical exclusively associated with a process and not the facility
	DI	Process Instrumentation	Instrumentation, measurement, recorders, devices and controllers (electrical and mechanical)
Mechanical			
	M-	All Mechanical	All or any portion of subjects in the following Level 2 Designators
	MD	Mechanical Demolition	Protection, termination, and removal
	MS	Mechanical Site	Utility tunnels and piping between facilities
	MH	Mechanical HVAC	Ductwork, air devices, and equipment
	MP	Mechanical Piping	Chilled and heated water, steam
	MI	Mechanical Instrumentation	Instrumentation and controls

Table 5 (Concluded)			
Discipline	Designator	Description	Content
Electrical			
	E-	All Electrical	All or any portion of subjects in the following Level 2 Designators
	EA*	Electrical Airfield Lighting and Nav aids	Visual air navigation systems
	ED	Electrical Demolition	Protection, termination, and removal
	ES	Electrical Site	Exterior electrical systems (power, lighting, telecommunications, auxiliary)
	EP	Electrical Interior Power	Interior power
	EL	Electrical Interior Lighting	Interior lighting
	EI	Electrical Instrumentation	Controls, relays, instrumentation, and measurement devices
	ET	Electrical Interior Telecommunications	Interior telecommunications (telephone, network, voice and data cables)
	EY	Electrical Interior Auxiliary Systems	Interior auxiliary (alarms, nurse call, security, CCTV, PA, music, clock, and program)
Telecommunications			
	T-	All Telecommunications	All or any portion of subjects in the following Level 2 Designators
	TD*	Telecommunications Demolition	Protection, termination, and removal
	TN	Data Networks	Network cabling and equipment
	TT	Telephone	Telephone systems, wiring, and equipment
Resource			
	R-	All Resource	All or any portion of subjects in the following Level 2 Designators
	RC	Resource Civil	Surveyor's information and existing civil drawings
	RS	Resource Structural	Existing facility structural drawings
	RA	Resource Architectural	Existing facility architectural drawings
	RM	Resource Mechanical	Existing facility mechanical drawings
	RE	Resource Electrical	Existing facility electrical drawings
Other Disciplines	X		
Contractor/Shop Drawings	Z		
Operations	O		
* = Not in NCS 2.0			

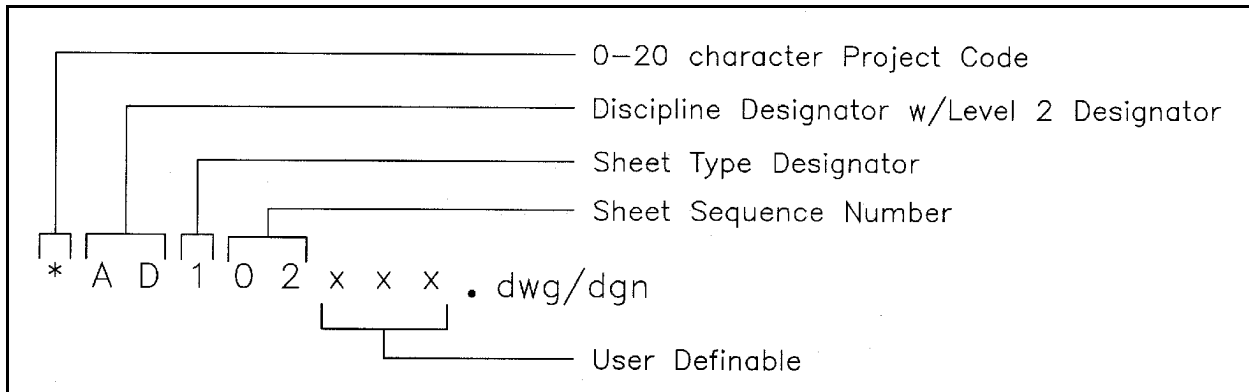

Figure 6. Sheet file naming convention

Table 6 Sheet Type Designators	
Sheet Type	Designator
General (symbols legend, notes, etc.)	0
Plans (horizontal views)	1
Elevations (vertical views)	2
Sections (sectional views)	3
Large Scale Views (plans, elevations, or sections that are not details)	4
Details	5
Schedules and Diagrams	6
User Defined	7
User Defined	8
3D Representations (isometrics, perspectives, photographs)	9

Note: If the sheet sequence number goes above 99 sheets for a particular discipline, the first character in the User Definable field could be used to expand the limit of sheets per discipline to 999. However, if more than 99 sheets are required for one discipline's drawings, the user might want to consider using the Level 2 Designator in the Discipline Designator to further subdivide the discipline (see Table 5).

Note: Occasionally, more than one Sheet Type (e.g., plan, elevation, detail) will be represented in one sheet file. If this is the case, the dominant sheet type determines the Sheet Type Designator.

Example: The sheet file name for a project at ERDC, Building 8000, 1st floor, Quadrant B, Architectural Floor Plan, sheet sequence 02 could be:

ERDC8000A-102F1B.dgn/dwg

where ERDC8000 is the Project Code, A- is the Discipline Designator, 1 is the Sheet Type Designator (Plan), 02 is the Sheet Sequence Number, and F1B is a user-definable set of characters for Floor 1, Quadrant B.

Coordination Between Sheet File Name and Sheet Identifier

In assigning a sheet identifier (for use in the sheet identification block, reference bubbles, etc.), the user should coordinate with the name assigned to the electronic sheet file. The sheet identifier should consist of the discipline designator, sheet type designator, and the sheet sequence number (Figure 7).

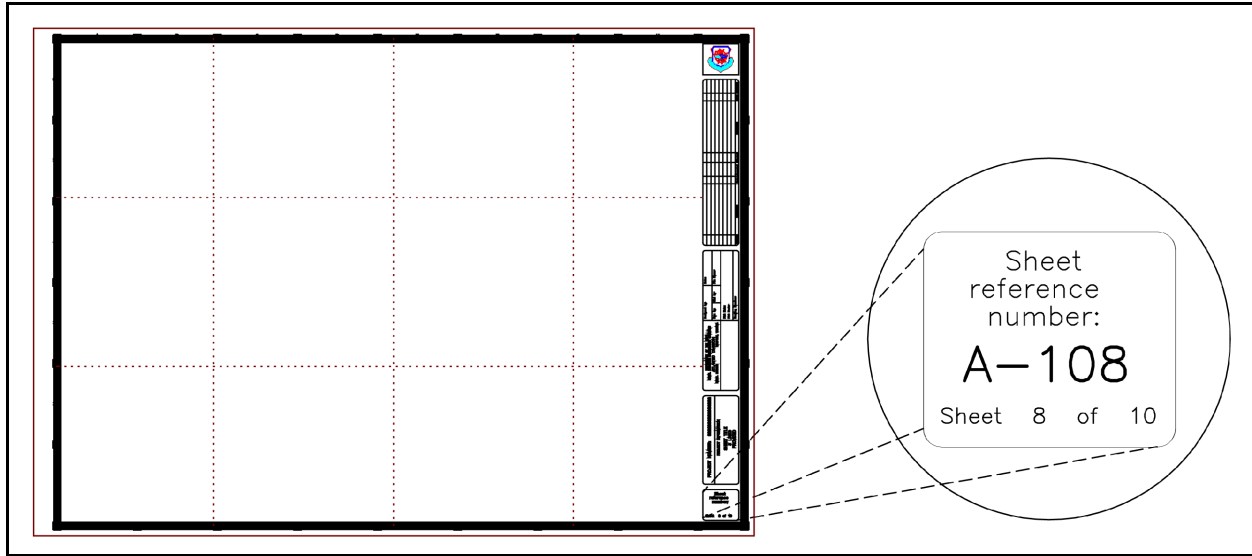

Figure 7. Typical border sheet title block with sheet identification block

As far as the sequence of the discipline designators in a drawing set, the National CAD Standard mandates that the disciplines follow the order as shown in Table 3.

3 Graphic Concepts

Presentation Graphics









The first step in establishing an effective CADD standard is the development of a uniform approach to presentation graphics. Presentation graphics typically consist of drawing elements such as lines, arcs, shapes, text, and their attributes (line color, line width, and line style). This chapter presents brief overviews of the characteristics of presentation graphics and the philosophy used to standardize them.

Line widths

Although “monotone” line work is not contractually improper, varied line widths substantially improve readability. Most commercial CADD systems provide an extensive variety of line widths. However, for the majority of A/E/C drawings, the five line widths defined

in Table 7, with the optional 1.00 mm, 1.40 mm, and 2.00 mm lines, are considered sufficient and should not be expanded unless an appreciable improvement in drawing clarity or contrast can be realized. The following are typical usages for the line widths shown in Table 7:

- Fine (0.18 mm). Fine lines should be used sparingly, mostly for poche/patterning (this line thickness typically does not reproduce well in blue-line format and/or in photocopies).
- Thin (0.25 mm). Thin lines should be used for depicting dimension lines, dimension leader/witness lines, note leader lines, line terminators (arrowheads, dots, slashes), phantom lines, hidden lines, center lines, long break lines, schedule grid lines, and object lines seen at a distance.









Line Thickness	Technical Pen Designation ¹	mm	in.	MicroStation Line Weight ²	Line Weight Example
Fine	0000	0.18	0.007	wt = 0	
Thin	000	0.25	0.010	wt = 1	
Medium	0	0.35	0.014	wt = 2	
Wide	1	0.50	0.020	wt = 3	
Extra Wide	2.5	0.70	0.028	wt = 5	
Option 1	3.5	1.00	0.040	wt = 7	
Option 2 ³	n/a	1.40	0.055	wt = 10	
Option 3 ³	n/a	2.00	0.079	wt = 15	

¹ Technical pen designation derived from Rapidograph and Rotring pen sizes.
² The weight of MicroStation lines remains constant when plotted, no matter if the design is scaled up or down.
³ Pens not standard for ink pen plotters.

- Medium (0.35 mm). Medium lines should be used for depicting minor object lines, dimension text, text for notes/callouts, and schedule text.
- Wide (0.50 mm). Wide lines should be used for major object lines, cut lines, section cutting plane lines, and titles.
- Extra wide (0.70 mm). Extra wide lines should be used for minor title underlining, schedule outlines, large titles, and object lines requiring special emphasis. For very large scale details drawn at 3 in. = 1 ft-0 in. or larger, the extra wide width should be used for the object lines. Extra wide widths are also appropriate for use as an elevation grade line, building footprint, or top of grade lines on section/foundation details.
- Option 1 (1.00 mm). This line weight should be used for major title underlining and separating portions of drawings.
- Option 2 (1.40 mm). This line weight should be used for border sheet outlines and cover sheet line work, and as an option for the designer as required.
- Option 3 (2.00 mm). This line weight should be used for border sheet outlines and cover sheet line work and as an option for the designer as required.

Line types/styles

The line types/styles selected for this standard are listed in Table 8. Only line IDs 0, 2, 7 and 11 are included in ISO 128 (ISO 1982). The CGTC has created line style files for MicroStation and AutoCAD (called *tsaec.rsc* and *tsaec.lin*, respectively) which include the line styles in Table 9, as well as additional discipline line styles. Appendix D contains additional line styles utilized in the standard. These files are available on the Release 2.0 CD, as well as on the CGTC's Internet site at tsc.wes.army.mil.

Table 8 Standard Line Types/Styles				
ID	Description	Example	MicroStation Designator	AutoCAD Designator
0	Continuous		0	Continuous
1	Dotted		1	ACAD_ISO07W100
2	Dashed		2	ACAD_ISO02W100
3	Dashed spaced		3	ACAD_ISO03W100
4	Dashed dotted		4	ACAD_ISO10W100
6	Dashed double-dotted		6	ACAD_ISO12W100
10	Dashed triple-dotted		_1	ACAD_ISO14W100
7	Chain		7	ACAD_ISO08W100
11	Chain double-dashed		_1	ACAD_ISO09W100

¹ This line style is not found in the default MicroStation line style resource file.

Line color

The primary reason to use color in CADD drawings is to improve the clarity of the drawing on a computer monitor. The variety of colors available in a CADD application depends on the capabilities of the computer monitor and its video card. Today, most systems are capable of displaying from 16 to 256 colors. Based on the limitations of monitor color display capabilities and differing CADD system plotting methods, this manual recommends that all A/E/C drawings be created using the basic colors presented in Table 9 whenever possible.

Note: *The recommended colors are best viewed on a monitor with a black background.*

Appendix C contains a 256-color map for the AutoCAD and MicroStation color palettes. The table maps AutoCAD's default color palette to MicroStation's default color palette. The color table is provided for those users who require more colors than the eight recommended by this standard.

Screening

Screened images are created through a process in which the density and pattern of black and white dots are varied to simulate different shades of gray. Varying the intensity of gray scales allows users to distinguish different aspects of a drawing when it is plotted. For example, an area on a site designated for demolition can be assigned a color that has been assigned a screening percentage. When plotted, the area will be shown at a lighter shade compared with other elements in the drawing. This will allow the contractor to immediately identify the demolition area on the drawing.

Table 10 lists colors recommended to be used for screening along with a recommended screening percentage. Using Table 10, MicroStation users can edit a plotter driver, using a text editor, to assign a screening percentage to the specific colors (see the MicroStation user's manuals for information on working with plotter/printer drivers).

Table 9 Screen Color Comparison					
Color	Color Number		Ratios of RGB, %		
	AutoCAD	MicroStation	Red	Green	Blue
Blue	5	1	0	0	255
Gray	8	9	128	128	128
Green	3	2	0	255	0
Red	1	3	255	0	0
Yellow	2	4	255	255	0
Magenta	6	5	255	0	255
Cyan	4	7	0	255	255
White	7	0	255	255	255

Note: Color numbers for AutoCAD and MicroStation were taken from default color tables.

**Table 10
Screened Colors**

AutoCAD				MicroStation			Gray Scale Ratios (RGB), percent		
Color No.	Line Width mm	Line Width in.	Screen percent	Color No.	Line Weight	Screen percent	Red	Green	Blue
10	0.18	0.007	10	10	0	10	230	230	230
11	0.25	0.010	10	19	1	10	230	230	230
12	0.35	0.014	10	27	2	10	230	230	230
13	0.50	0.020	10	35	3	10	230	230	230
14	0.70	0.028	10	43	5	10	230	230	230
15	1.00	0.039	10	51	7	10	230	230	230
16	1.40	0.055	10	59	10	10	230	230	230
19	2.00	0.079	10	83	15	10	230	230	230
50	0.18	0.007	20	20	0	20	204	204	204
51	0.25	0.010	20	28	1	20	204	204	204
52	0.35	0.014	20	36	2	20	204	204	204
53	0.50	0.020	20	44	3	20	204	204	204
54	0.70	0.028	20	52	5	20	204	204	204
55	1.00	0.039	20	60	7	20	204	204	204
56	1.40	0.055	20	68	10	20	204	204	204
59	2.00	0.079	20	92	15	20	204	204	204
90	0.18	0.007	30	82	0	30	179	179	179
91	0.25	0.010	30	106	1	30	179	179	179
92	0.35	0.014	30	92	2	30	179	179	179
93	0.50	0.020	30	122	3	30	179	179	179
94	0.70	0.028	30	114	5	30	179	179	179
95	1.00	0.039	30	138	7	30	179	179	179
96	1.40	0.055	30	130	10	30	179	179	179
99	2.00	0.079	30	170	15	30	179	179	179
130	0.18	0.007	40	87	0	40	153	153	153
131	0.25	0.010	40	95	1	40	153	153	153
132	0.35	0.014	40	103	2	40	153	153	153
133	0.50	0.020	40	111	3	40	153	153	153
134	0.70	0.028	40	119	5	40	153	153	153
135	1.00	0.039	40	127	7	40	153	153	153
136	1.40	0.055	40	135	10	40	153	153	153
139	2.00	0.079	40	159	15	40	153	153	153
170	0.18	0.007	50	97	0	50	128	128	128
171	0.25	0.010	50	105	1	50	128	128	128
172	0.35	0.014	50	113	2	50	128	128	128
173	0.50	0.020	50	121	3	50	128	128	128
174	0.70	0.028	50	129	5	50	128	128	128
175	1.00	0.039	50	137	7	50	128	128	128
176	1.40	0.055	50	145	10	50	128	128	128
179	2.00	0.079	50	169	15	50	128	128	128
210	0.18	0.007	50	85	0	50	128	128	128
211	0.25	0.010	50	109	1	50	128	128	128
212	0.35	0.014	50	101	2	50	128	128	128
213	0.50	0.020	50	125	3	50	128	128	128
214	0.70	0.028	50	117	5	50	128	128	128
215	1.00	0.039	50	141	7	50	128	128	128
216	1.40	0.055	50	133	10	50	128	128	128
219	2.00	0.079	50	173	15	50	128	128	128
250	0.25	0.010	50	8	1	50	128	128	128
251	0.35	0.014	50	200	2	50	128	128	128
252	0.50	0.020	50	168	3	50	128	128	128
253	0.70	0.028	50	120	5	50	128	128	128
254	1.00	0.039	50	56	7	50	128	128	128
255	2.00	0.079	50	24	15	50	128	128	128

AutoCAD users must specify requirements for screening according to the output device used. Due to the number of output devices AutoCAD supports, users should consult the help documentation provided within AutoCAD for information on assigning recommended screening percentages.

Text styles/fonts

Contrasting text styles (or fonts) are used within a drawing to delineate types of information. In most A/E/C drawings, the five fonts shown in Table 11 should be sufficient.

- **Monotext font.** This font creates text characters that are evenly spaced. Monotext font should be used where text fields need to be aligned such as in schedules or, in some cases, title blocks. In AutoCAD, use the `monotxt` font and in MicroStation use Font #3.
- **Proportional font.** This font creates text where the characters are proportionally spaced. It is appropriate for general notes, labels, or title blocks. In AutoCAD, use the romans (Roman Simplex) font with a width factor of 0.8. In MicroStation use Font #1.
- **Slanted font.** A slanted font is used where text needs to be easily distinguished from other text. This font can be created in AutoCAD by using the romans font with the Obliquing Angle set to 21.8 deg to achieve the American Standard slope of 2 in 5 (68.2 deg). In MicroStation use Font #23.
- **Filled font.** Filled fonts are used primarily for titles and on cover sheets. For AutoCAD, the recommended font is the swiss TrueType font (Note: The `TEXTFILL` system variable needs to be set to "1"). MicroStation users should use Font #43 (the Microsoft `arialbd.ttf` font file can be used as an alternate text style for the filled font).

- **Outline font.** When a pen plotter is used for final output, the outline font is used as a substitute for filled fonts for major titles such as cover sheet information to save plotting time. For AutoCAD, the recommended font is the `sasb` (Sans Serif-bold) PostScript font. For MicroStation, use Font #42.

Plotting

Printers and plotters are controlled by files called pen tables or feature tables. These files (tables) convert thicknesses and/or color in an electronic file to line thicknesses on a paper drawing.

This manual standardizes presentation graphics as they relate to electronic drawing files (screen display) and not the final printed or plotted paper drawing. By employing pen tables, each agency can ensure that consistent drawings are produced from an electronic file regardless of the type of printer or plotter used. It is the responsibility of each field activity to develop pen tables based on the printer/plotter used at that activity.

Border Sheets

Sheet sizes

Typical A/E/C projects (contract documents) will be prepared on A1 sheets in accordance with the ISO sheet size shown in Table 12, which also shows American National Standards Institute (ANSI) equivalents (American Society of Mechanical Engineers (ASME) Y14.1 (1995)).

The ISO A0 sheet is recommended for large maps (i.e., installation master plans and drawings for civil works projects).

Table 11
Comparison of Font Types

MicroStation	AutoCAD
<p>Monotext font (Font #3)</p> <p>ABCDEF GHIJKLMNOPQRST UVWXYZ abcdefghijklmnopqrst uvwxyz</p>	<p>Monotext font (monotxt)</p> <p>ABCDEF GHIJKLMNOPQRST UVWXYZ abcdefghijklmnopqrst uvwxyz</p>
<p>Proportional font (Font #1)</p> <p>ABCDEF GHIJKLMNOPQRST UVWXYZ abcdefghijklmnopqrst uvwxyz</p>	<p>Proportional font (romans)</p> <p>ABCDEF GHIJKLMNOPQRST UVWXYZ abcdefghijklmnopqrst uvwxyz</p>
<p>Slanted font (Font #23)</p> <p><i>ABCDEF GHIJKLMNOPQRST UVWXYZ abcdefghijklmnopqrst uvwxyz</i></p>	<p>Slanted font (romans, obliquing angle = 21.8)</p> <p><i>ABCDEF GHIJKLMNOPQRST UVWXYZ abcdefghijklmnopqrst uvwxyz</i></p>
<p>Filled font (Font #43)</p> <p>ABCDEF GHIJKLMNOPQRST UVWXYZ abcdefghijklmnopqrst uvwxyz</p>	<p>Filled font (swiss)</p> <p>ABCDEF GHIJKLMNOPQRST UVWXYZ abcdefghijklmnopqrst uvwxyz</p>
<p>Outline font (Font #42)</p> <p>ABCDEF GHIJKLMNOPQRST UVWXYZ abcdefghijklmnopqrst uvwxyz</p>	<p>Outline font (sasb)</p> <p>ABCDEF GHIJKLMNOPQRST UVWXYZ abcdefghijklmnopqrst uvwxyz</p>

Table 12
ISO, ANSI, and Architectural Sheet Size Comparison

ISO Designation	Width		Length		ANSI Equivalent		Architectural Equivalent	
	mm	in.	mm	in.	Letter	in.	Letter	in.
NA	NA	NA	NA	NA	F	28.0 x 40.0	F	30.0 x 42.0
A0	841	33.11	1189	46.81	E	34.0 x 44.0	E	36.0 x 48.0
A1	594	23.39	841	33.11	D	22.0 x 34.0	D	24.0 x 36.0
A2	420	16.54	594	23.39	C	17.0 x 22.0	C	18.0 x 24.0
A3	297	11.69	420	16.54	B	11.0 x 17.0	B	12.0 x 18.0
A4	210	8.27	297	11.69	A	8.5 x 11.0	A	9.0 x 12.0

Note: Users plotting A1 size drawings on ANSI D-size paper should reduce the width of the A1 border from 594 mm (23.39 in.) to 559 mm (22.0 in.). The length can remain the same. This revised border will fit on an ANSI D-size sheet (22 by 34 in.) and can be reproduced on standard office photocopiers.

Title block

The CGTC recommends the use of a vertical title block placed in the right-hand margin of the border sheet as shown in Figure 8. Use of the vertical title block provides the most usable drawing space on a sheet. The vertical title block also ensures that the most prevalent and pertinent information remains at the bottom right of the sheet. In compliance with the *Uniform Drawing System* (CSI 2001), title block data will include the following:

- Designer identification block
- Issue block
- Management block
- Project identification block/sheet title block
- Sheet identification block

Note: Local standards may modify the content of the title block but should not alter its size or configuration if possible. See the *Uniform Drawing System* for additional recommendations.

Designer identification block. The designer identification block (Figure 9) contains the logo or name of the agency that designed the sheet. This space could also be expanded (by reducing the size of the issue block) to accommodate professional seals when required.

Issue block. The issue block (Figure 10) contains a history of revisions, addenda, and/or clarifications to the sheet. The first entry should be placed on the lower left-hand line of the issue block and subsequent entries should be made above it.

Management block. The management block (Figure 11) contains information about the designer, reviewer, and submitter. This block can also be used to maintain filing information about the drawing, such as the file name, plot scale, and drawing code (this information is sometimes plotted outside the drawing sheet cut line). If an A-E has developed the drawings, there is room for information about the firm in the lower left portion of the block.

Project identification block/sheet title block. The project identification block/sheet title block (Figure 12) contains two sets of information. First, the project name is identified, possibly with the location or phase of the project identified. If small enough, a project logo can be presented in this block. The second set of information contains a description of the content of the sheet (e.g., Architectural Floor Plan). If more than one type of information is presented on the sheet (i.e., plans, schedules, details), the most important information is identified.

Sheet identification block. The sheet identification block (Figure 13) contains the sheet identifier. This sheet identifier is composed of the discipline designator, the sheet type designator, and the sheet sequence number described in the section, “Electronic Drawing File Naming Conventions” (Chapter 2). The “number of sheets” listing is optional and can contain either the total number of sheets for the entire project drawing set or the number of sheets for that particular discipline designator.

Drawing Scales

Typical drawing scales for both SI and inch-pound measurements are indicated in Table 13.

The A/E/C CADD Standard recommends text heights for these scales in accordance with Leroy lettering sizes. Table 14 lists recommended text sizes using inch-pound scales. Table 15 lists recommended text sizes using metric scales.

Dimensioning in Metric (SI)

Methodologies for dimensioning metric (SI) drawings are based upon the recommendations of the Construction Metrication Council of the National Institute of Building Sciences (NIBS), Washington, DC. These recommendations comply with the American Society for Testing and Materials (ASTM) E 621-94, “Standard Practice for the Use of Metric (SI) Units in Building Design and Construction” (ASTM 1999).

Millimeters

The preferred unit of measure for most A/E/C work is millimeters. Unit notations are unnecessary and should not be used. The dimension is provided as a whole number as shown in Figure 14. Also, a note should be added to the drawing stating, “All dimensions and/or dimensions shown in callouts/notes are in millimeters unless otherwise noted.”

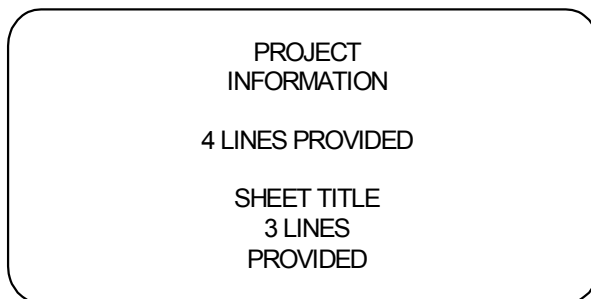

Figure 12. Project identification block/sheet title block

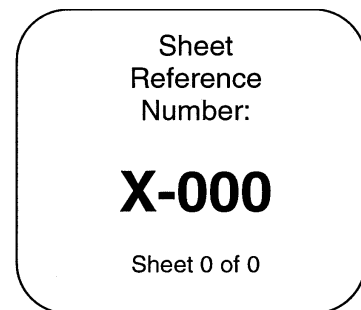

Figure 13. Sheet identification block

**Table 13
Drawing Scales**

Drawing Type	Metric	Inch-Pound
Site plans	1:200	1" = 20' - 0"
	1:400	1" = 30' - 0"
	1:500	1" = 40' - 0"
	1:600	1" = 50' - 0"
	1:700	1" = 60' - 0"
	1:1000	1" = 100' - 0"
	1:2000	1" = 200' - 0"
	1:5000	1" = 400' - 0"
	1:6000	1" = 500' - 0"
	1:10000	1" = 1000' - 0"
	1:20000	1" = 2000' - 0"
	Floor plans	1:50
1:100		1/8" = 1' - 0"
1:200		1/16" = 1' - 0"
Roof plan	1:200	1/16" = 1' - 0"
Exterior elevations	1:100	1/8" = 1' - 0"
	1:200	1/16" = 1' - 0"
Interior elevations	1:50	1/4" = 1' - 0"
	1:100	1/8" = 1' - 0"
Cross sections	1:50	1/4" = 1' - 0"
	1:100	1/8" = 1' - 0"
	1:200	1/16" = 1' - 0"
Wall sections	1:20	1/2" or 3/4" = 1' - 0"
Stair details	1:10	1" or 1-1/2" = 1' - 0"
Details	1:5	3" = 1' - 0"
	1:10	1" or 1-1/2" = 1' - 0"

Table 14 Inch-pound Text Sizes																
Leroy Lettering Sizes		60	80	100	120	140	175	200	240	290	350	425	500	1000		
Decimal Inch Equivalents		0.060	0.080	0.100	0.120	0.140	0.175	0.200	0.240	0.290	0.350	0.425	0.500	1.000		
		Text Sizes In Feet And Inches														
Drawing Scale =	1" = 2000'-0"	120:0	160:0	200:0	240:0	280:0	350:0	400:0	480:0	580:0	700:0	850:0	1000:0	2000:0		
Drawing Scale =	1" = 1000'-0"	60:0	80:0	100:0	120:0	140:0	175:0	200:0	240:0	290:0	350:0	425:0	500:0	1000:0		
Drawing Scale =	1" = 500'-0"	30:0	40:0	50:0	60:0	70:0	87:6	100:0	120:0	145:0	175:0	212:6	250:0	500:0		
Drawing Scale =	1" = 400'-0"	24:0	32:0	40:0	48:0	56:0	70:0	80:0	96:0	116:0	140:0	170:0	200:0	400:0		
Drawing Scale =	1" = 200'-0"	12:0	16:0	20:0	24:0	28:0	35:0	40:0	48:0	58:0	70:0	85:0	100:0	200:0		
Drawing Scale =	1" = 100'-0"	6:0	8:0	10:0	12:0	14:0	17:6	20:0	24:0	29:0	35:0	42:6	50:0	100:0		
Drawing Scale =	1" = 60'-0"	3:7	4:10	6:0	7:2	8:5	10:6	12:0	14:5	17:5	21:0	25:6	30:0	60:0		
Drawing Scale =	1" = 50'-0"	3:0	4:0	5:0	6:0	7:0	8:9	10:0	12:0	14:6	17:6	21:3	25:0	50:0		
Drawing Scale =	1" = 40'-0"	2:5	3:2	4:0	5:0	5:8	7:0	8:0	9:8	11:8	14:0	17:0	20:0	40:0		
Drawing Scale =	1" = 30'-0"	1:10	2:5	3:0	3:7	4:2	5:3	6:0	7:2	8:8	10:6	12:9	15:0	30:0		
Drawing Scale =	1" = 20'-0"	1:2	1:7	2:0	2:5	2:10	3:6	4:0	4:10	5:10	7:0	8:6	10:0	20:0		
Drawing Scale =	3" = 1'-0"	:0.2	:0.3	:0.4	:0.5	:0.6	:0.7	:0.8	:1	:1.2	:1.4	:1.7	:2	:4		
Drawing Scale =	1-1/2" = 1'-0"	:0.5	:0.6	:0.8	:1	:1.1	:1.4	:1.6	:2	:2.3	:2.8	:3.4	:4	:8		
Drawing Scale =	1" = 1'-0"	:0.7	:1	:1.2	:1.5	:1.7	:2.1	:2.4	:2.8	:3.5	:4.2	:5	:6	1:0		
Drawing Scale =	3/4" = 1'-0"	:1	:1.3	:1.6	:2	:2.2	:2.8	:3.2	:3.8	:4.6	:5.6	:7	:8	1:4		
Drawing Scale =	1/2" = 1'-0"	:1.5	:2	:2.4	:3	:3.4	:4.2	:4.8	:5.8	:7	:8.4	:10	1:0	2:0		
Drawing Scale =	3/8" = 1'-0"	:2	:2.5	:3	:4	:4.5	:5.6	:6.4	:7.7	:9.3	:11	1:1	1:4	2:8		
Drawing Scale =	1/4" = 1'-0"	:3	:4	:5	:6	:7	:8.4	:9.6	1:0	1:2	1:5	1:8	2:0	4:0		
Drawing Scale =	1/8" = 1'-0"	:6	:8	:10	1:0	1:1	1:5	1:7	1:11	2:4	2:10	3:5	4:0	8:0		
Drawing Scale =	3/32" = 1'-0"	:8	:10	1:0	1:3	1:6	1:10	2:1	2:6	3:1	3:8	4:6	5:4	10:8		
Drawing Scale =	1/16" = 1'-0"	1:0	1:3	1:7	2:0	2:3	2:10	3:2	3:10	4:8	5:7	6:10	8:0	16:0		
Drawing Scale =	1/32" = 1'-0"	2:0	2:6	3:2	3:10	4:6	5:7	6:5	7:8	9:4	11:2	13:7	16:0	32:0		
Drawing Scale =	FULL	:0.060	:0.080	:0.100	:0.120	:0.140	:0.175	:0.200	:0.240	:0.290	:0.350	:0.425	:0.500	1:000		

Table 15

Metric Text Sizes

Leroy Lettering Sizes		60	80	100	120	140	175	200	240	290	350	425	500	1000
Millimeter Approximates		1.5	2	2.5	3	3.5	4.5	5	6	7.5	9	11	12	25
Text Sizes In Millimeters														
Drawing Scale = 1:20000		30000	40000	50000	60000	70000	90000	100000	120000	150000	180000	220000	240000	500000
Drawing Scale = 1:10000		15000	20000	25000	30000	35000	45000	50000	60000	75000	90000	110000	120000	250000
Drawing Scale = 1:6000		9000	12000	15000	18000	21000	27000	30000	36000	45000	54000	66000	72000	150000
Drawing Scale = 1:5000		7500	10000	12500	15000	17500	22500	25000	30000	37500	45000	55000	60000	125000
Drawing Scale = 1:2000		3000	4000	5000	6000	7000	9000	10000	12000	15000	18000	22000	24000	50000
Drawing Scale = 1:1000		1500	2000	2500	3000	3500	4500	5000	6000	7500	9000	11000	12000	25000
Drawing Scale = 1:700		1050	1400	1750	2100	2450	3150	3500	4200	5250	6300	7700	8400	17500
Drawing Scale = 1:600		900	1200	1500	1800	2100	2700	3000	3600	4500	5400	6600	7200	15000
Drawing Scale = 1:500		750	1000	1250	1500	1750	2250	2500	3000	3750	4500	5500	6000	12500
Drawing Scale = 1:400		600	800	1000	1200	1400	1800	2000	2400	3000	3600	4400	4800	10000
Drawing Scale = 1:200		300	400	500	600	700	900	1000	1200	1500	1800	2200	2400	5000
Drawing Scale = 1:100		150	200	250	300	350	450	500	600	750	900	1100	1200	2500
Drawing Scale = 1:50		75	100	125	150	175	225	250	300	375	450	550	600	1250
Drawing Scale = 1:20		30	40	50	60	70	90	100	120	150	180	220	240	500
Drawing Scale = 1:10		15	20	25	30	35	45	50	60	75	90	110	120	250
Drawing Scale = 1.5		7.5	10	12.5	15	17.5	22.5	25	30	37.5	45	55	60	125
Drawing Scale = 1:2.5		3.75	5	6.25	7.5	8.75	11.25	12.5	15	18.75	22.5	27.5	30	62.5
Drawing Scale = FULL		1.5	2	2.5	3	3.5	4.5	5	6	7.5	9	11	12	25

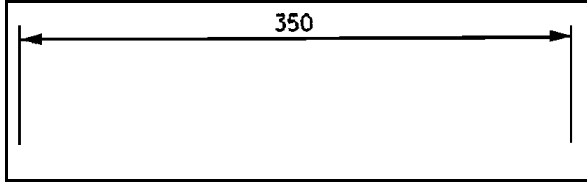

Figure 14. Dimension in millimeters. Always shown as a whole number

When meter measurements are included on the same sheet, the meter dimension is provided as a real number taken to three places past the decimal point (Figure 15). Again, unit notations are unnecessary.

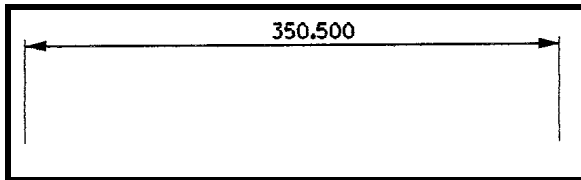

Figure 15. Dimension in meters. Always shown as a real number (with decimal)

Note: *In circumstances where very small dimensions are used (e.g., machine details), it is permissible to use real numbers for millimeter dimensions. A note should be placed on the detail regarding this fact.*

Meters

For site plans or other drawings drawn to scales over 1:200, the unit of measure is typically meters. Where greater accuracy is required, show dimensions to three decimal places (Figure 15). A note should be added to the drawing stating, "All dimensions and/or dimensions shown in callouts/notes are in meters unless otherwise noted."

Large units of measure

Commas shall not be used when providing large units of measure; instead, a space replaces the traditional comma in numbers containing

five or more digits (e.g., the number 45,000 is displayed as 45 000). In numbers containing four digits, no space is used (e.g., 5000). Both methods are shown in Figure 16.

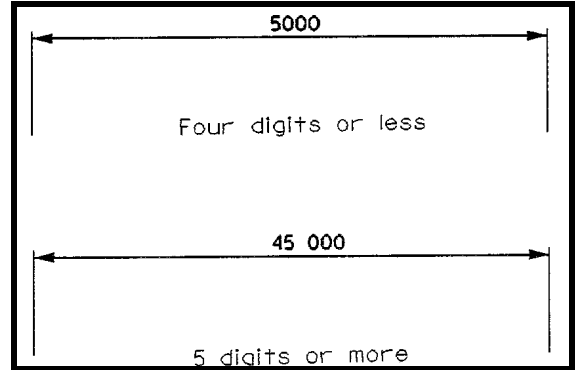

Figure 16. Proper dimension presentations for metric measurements with four or more digits

The Unit Separation toggle under the *Unit Format* setting for Dimension Settings can be used to add a space after the thousands place in a value (Figure 17). Since toggling this value on and off for drawing files containing varying dimension values would be tedious, recommend toggling Unit Separation "on" for files containing *any* dimension values over 5 digits and "off" for files containing dimension values with *only* 4 or fewer digits.

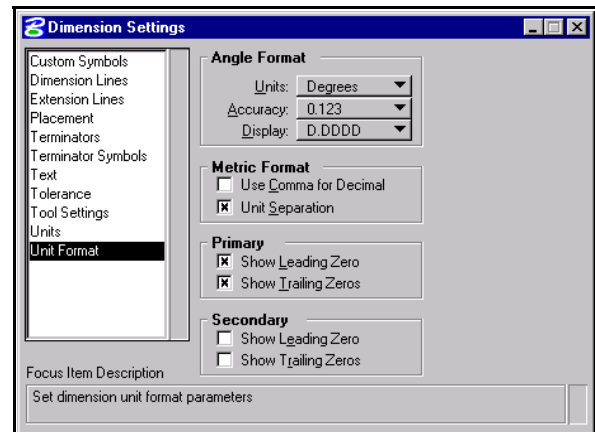

Figure 17. Unit format

Note: *The automatic dimensioning features of AutoCAD do not allow users to replace commas with spaces in dimension text. The dimension text will presently have to be edited to provide the spacing required by ASTM E 621-94 (ASTM 1999).*

Dual units

To avoid confusion, dual units (both inch-pound and metric) should not be used. As stated in Construction Metrication Council (1998), use

of dual units “increases dimensioning time, doubles the chance for errors, makes drawings more confusing, and only postpones the (metric) learning process.”

Exceptions to this include certain “standard building designs” where dual dimensions ensure that the design can be used in either SI or inch-pound projects and in situations where products/components used in an SI project are available only as inch-pound products.

4 Level/Layer Assignments

Levels/Layers

CADD levels or layers are analogous to overlays in manual drafting systems and serve to

separate graphic elements (lines, shapes, and text) according to the design discipline they represent (Figure 18).

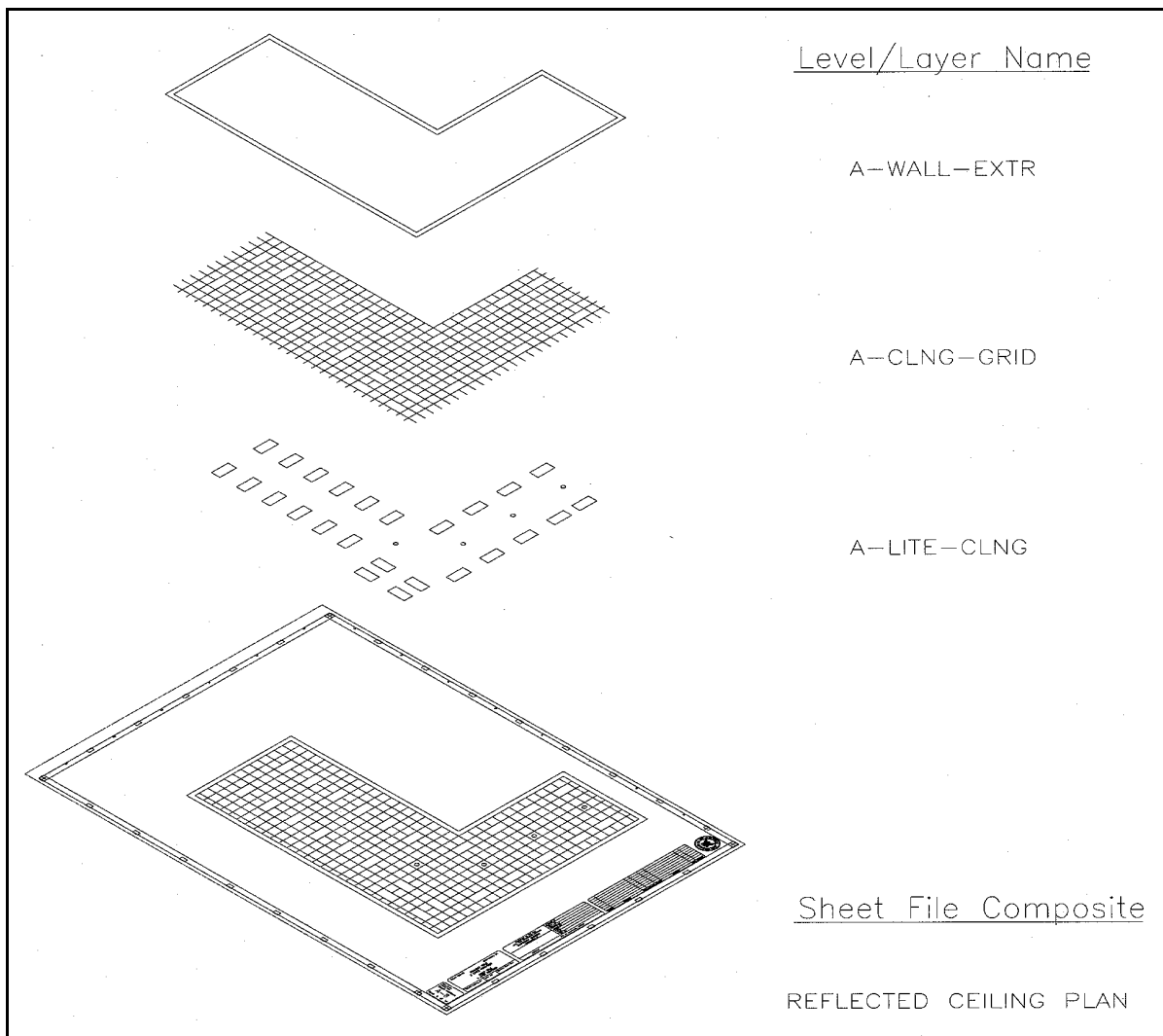

Figure 18. Typical levels/layers contained in a sheet file

The types of information represented by individual levels/layers can be grouped into two primary types: model-specific information and sheet-specific information (Figure 19).

- Model-specific information represents the physical form of a site, a building, or objects

composing a building. This information is often shared between drawings. Examples include walls, doors, light fixtures, and room numbers. Model-specific information may be either literal (e.g., walls) or symbolic (e.g., electrical outlets).

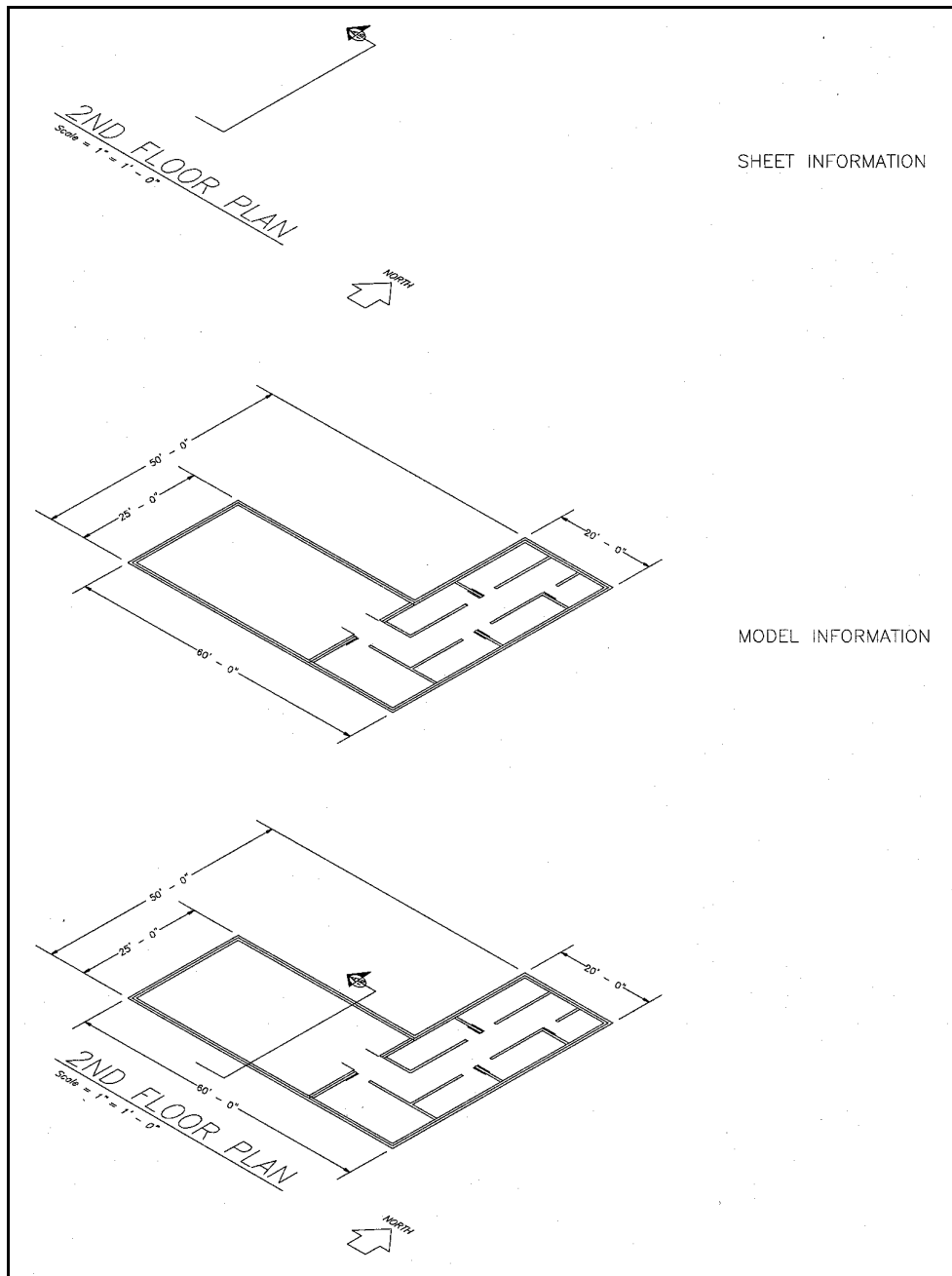

Figure 19. Sheet- and model-specific information

- Sheet-specific information may include notes, annotative symbols, and titles. This type of information is usually not shared between drawings.

To use and manipulate model-specific and sheet-specific information effectively, every level/layer must be defined (standardized) by its name and its use.

Level/layer naming convention

The reuse, not duplication, of graphic information reduces drawing time and improves project coordination. The level/layer is the basic tool used in CADD for managing graphic information. The levels/layers defined within these standards are based on the recommendations set forth in "AIA CAD Layer Guidelines" (AIA 2001).

Level/layer names consist of a two-character *Discipline Designator* (e.g., "A-" for Architectural, "M-" for Mechanical), followed by a four-character *Major Group* (e.g., "DOOR" for Doors, "LITE" for Lighting Fixtures), followed by four-character *Minor Group* (e.g., A-WALL-FULL-EXTR for exterior full height walls versus A-WALL-FULL-INTR for interior full height walls) (Figure 20).

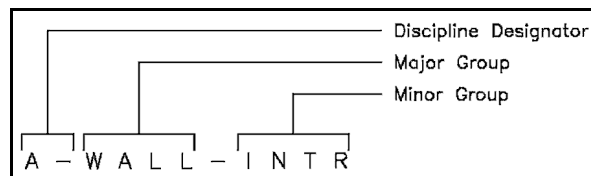

Figure 20. Level/layer naming format

ISO format

ISO 13567-2 (ISO 1998) presents an international method for level/layer naming (Figure 21). This method consists of 10 mandatory alphanumeric characters, followed by 10 optional alphanumeric characters. The first two-character field, *Agent Responsible*,

correlates to the AIA's Discipline Designator. The following six-character field, *Element*, can map to a shortened version of the AIA's Major and Minor Groups (e.g., DOOR-FULL becomes DOORFU, DOOR-PRHT becomes DOORPR). The final two-character field in the mandatory level/layer name, *Presentation*, designates whether the level/layer information is Model information (i.e., model-specific information) or Page/Paper information (i.e., sheet-specific information). Appendix A gives a corresponding ISO Format level/layer name for each AIA Format level/layer name.

Model Files

As mentioned in Chapter 2, model files represent full-size drawings of building elements, systems, or information (e.g., the mechanical HVAC system, the architectural floor plan, details, sections) and sheet files represent final plotted sheets. Model files are used as components in creating plotted sheet files. The information contained within a model file for a discipline may be referenced by other disciplines to create the particular model files or sheet files for that discipline.

A model file can be considered a "work in progress." For instance, a mechanical engineer may reference the architect's floor plan model file to begin development of the HVAC ductwork layout model file. Meanwhile, the architect can continue developing the floor plan to meet new requirements. Any changes to the floor plan would be immediately accessible to the mechanical engineer. The viewing of real-time updates eliminates a great deal of frustration for other disciplines because it allows for on-the-spot rather than after-the-fact modifications.

Level/layer assignment tables

The level/layer assignment tables in Appendix A present the following (Figure 22 presents an excerpt):

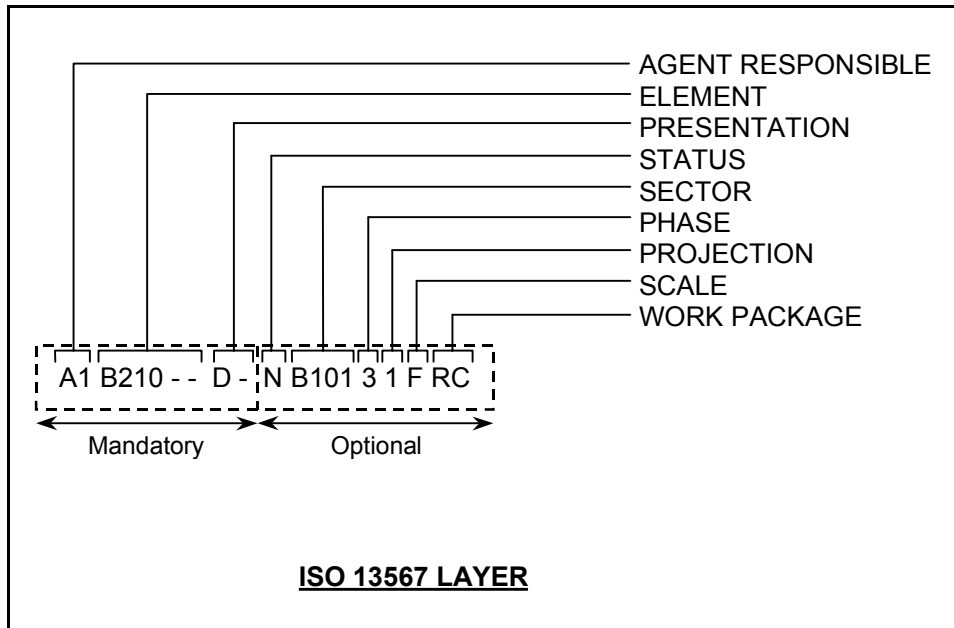

Figure 21. ISO 13567-2 level/layer naming method

- The levels/layers assigned to each model file.
- The level number assigned to each level/layer name (MicroStation users only).
- An AIA and corresponding ISO format level/layer name for each level/layer.
- A detailed description for each level/layer.
- The presentation graphics associated with each level/layer. This includes the line style, line width, and color.

Annotation levels/layers. Users should note that the first eight level/layers for every model file type (with the exception of detail model file types) are the same, the only difference being that the Discipline Designator changes depending on the discipline for that model file type. The unique function of these eight annotation levels/layers is to contain model-specific information that might not be required by other disciplines. These levels/layers are as follows with ** representing a Discipline Designator (e.g., A-, C-):

- **ANNO-DIMS
Witness/extension lines, dimension terminators and dimension text.
- **ANNO-KEYN
Reference keynotes with associated leaders.
- **ANNO-NOTE
General notes and remarks.
- **ANNO-NPLT
Non-plotting graphic information.
- **ANNO-PATT
Miscellaneous patterning and hatching.
- **ANNO-SYMB
Miscellaneous symbols.
- **ANNO-TEXT
Miscellaneous text and callouts with associated leaders.
- **ANNO-REFR
An AutoCAD user-specific layer for use in attachment of external references (i.e., reference files).

Demolition levels/layers. Users should note that several model files have three levels/layers reserved for demolition items. These levels/layers are as follows with ** representing a Discipline Designator (e.g., A-, C-):

Discipline: Architectural Model File Type: Floor Plan							
Level #	Level/Layer Naming		Level/Layer Description	Graphics			
	AIA Format	ISO Format		Line Style	Line Width (mm)	AutoCAD Line Color#	MicroStation Line Colo
General Information							
1	A-ANNO-DIMS	A----DIP-	Witness/extension lines, dimension terminators, dimension text	0	V	V	V
2	A-ANNO-KEYN	A----KEP-	Reference keynotes with associated leaders	0	V	V	V
3	A-ANNO-NPLT	A----NPP-	Non-plotting graphic information	V	0.18	B/5	B/1
4	A-ANNO-PATT	A----PAP-	Miscellaneous patterning and hatching	0	0.18	Gr/8	Gr/9
5	A-ANNO-NOTE	A----NOP-	General notes and general remarks	0	0.35	Y/2	Y/4
6	A-ANNO-SYMB	A----SYP-	Miscellaneous symbols	V	0.35	M/6	M/5
7	A-ANNO-TEXT	A----TEP-	Miscellaneous text and callouts with associated leaders	0	V	V	V
NA	A-ANNO-REFR	A----RFP-	Reference files (AutoCAD users only, see Chapter 4)	NA	NA	NA	NA
Floor Information							
10	A-FLOR-IDEN	A-FLORIDM-	Room name, space identification text	0	0.25	G/3	G/2
11	A-FLOR-NUMB	A-FLORNUM-	Room/space identification number and symbol	0	0.25	G/3	G/2
12	A-FLOR-FIXT	A-FLORFIM-	Floor mounted/Free standing miscellaneous fixtures	0	0.25	G/3	G/2
13	A-FLOR-LEVL	A-FLORLEM-	Level changes, shafts, ramps, pits, breaks in construction, and depressions	0	0.35	M/6	M/5
15	A-FLOR-OTLN	A-FLOROTM-	Floor outline/perimeter/building footprint	0	0.35	M/6	M/5
16	A-FLOR-PATT	A-FLORPAM-	Paving, tile, carpet patterns	0	0.18	Gr/8	Gr/9
17	A-FLOR-RAIS	A-FLORRAM-	Access (raised) flooring	0	0.25	G/3	G/2
18	A-FLOR-RPRM	A-FLORRPM-	Room perimeter shape (interior walls)	0	0.35	Y/2	Y/4
19	A-FLOR-SIGN	A-FLORSIM-	Signage	0	0.25	R/1	R/3
20	A-FLOR-SPCL	A-FLORSPM-	Architectural specialties (e.g., toilet room accessories, display cases)	0	0.25	G/3	G/2

Figure 22. Model file level/layer assignment table

****STAT-DEMO-PHS1**

Demolition - phase 1.

****STAT-DEMO-PHS2**

Demolition - phase 2.

****STAT-DEMO-PHS3**

Demolition - phase 3.

These levels/layers should only be used when an Existing/Demolition model file is being created (see Chapter 2, "Model File naming convention"). For instance, the architect or engineer will sometimes have existing as-built model files, such as Site Plans and Floor Plans from a previous project. A copy of the as-built file will be made for use in the current project. This copy is renamed to be the Existing/Demolition Plan model file for that discipline. In order to distinguish items to be demolished from existing items that will remain, those items should be moved to the Demolition levels/layers (if the demolition is not phased, all items should be moved to the ****STAT-DEMO-PHS1** level/layer). When the Existing/Demolition Plan model file is referenced into a new file to create the New construction items, the Demolition levels/layers would be turned off.

Border sheets

As mentioned before, a model file contains information that can be referenced by other disciplines to create other model files or final sheet files. A border sheet model file contains border sheet linework, the title block, and project-specific symbols and text. Typically, each discipline will use the same border sheet and fill in sheet-specific information within the title block or revision block prior to printing the final sheet file (e.g., sheet number, designer names).

Reference files (XREFs)

Reference files (external references or XREFs) enable designers to share drawing information electronically, eliminating the need to exchange hard copy drawings between the design disciplines. With the use of reference files, the structural engineer need not wait for the architect to complete the architectural floor plans before beginning the structural framing plan model file. Nor does the engineer have to redraw the architect's structural walls on the structural framing plan model file.

Referencing electronic drawing information makes any future changes made by the architect apparent to the structural designer. This real-time access to the work of others ensures accuracy and consistency within a set of drawings and helps promote concurrent design efforts. No longer does one discipline have to wait until another discipline is nearly finished before they begin their drawings.

The use of reference files is a key component in the successful use of the level/layer assignments. To create either a model file or a final sheet file, multiple referenced model files may be required. Figure 23 shows how a simple Plumbing Piping Plan model file is developed using levels/layers referenced from the Enlarged Floor Plan model file. These referenced levels/layers show the current locations of walls, toilets, and sinks placed by the architect. The engineer uses this information to design the piping system required to service the plumbing fixtures. The architectural floor plan would then be detached and the Plumbing Piping Plan would be saved as a separate model file.

Sheet Files

Sheet files are the final project sheets that are ready to be plotted. A sheet file is an assembly of referenced model files plus additional sheet-specific information (e.g., north arrows, scales, section cuts, title block information).

Level/layer assignment tables

The level/layer assignment tables in Appendix B present the following (Figure 24):

- The levels/layers assigned to each sheet file.
- The level number assigned to each level/layer (MicroStation users only).
- An AIA and corresponding ISO format level/layer name for each level/layer.
- A detailed definition for each level/layer.

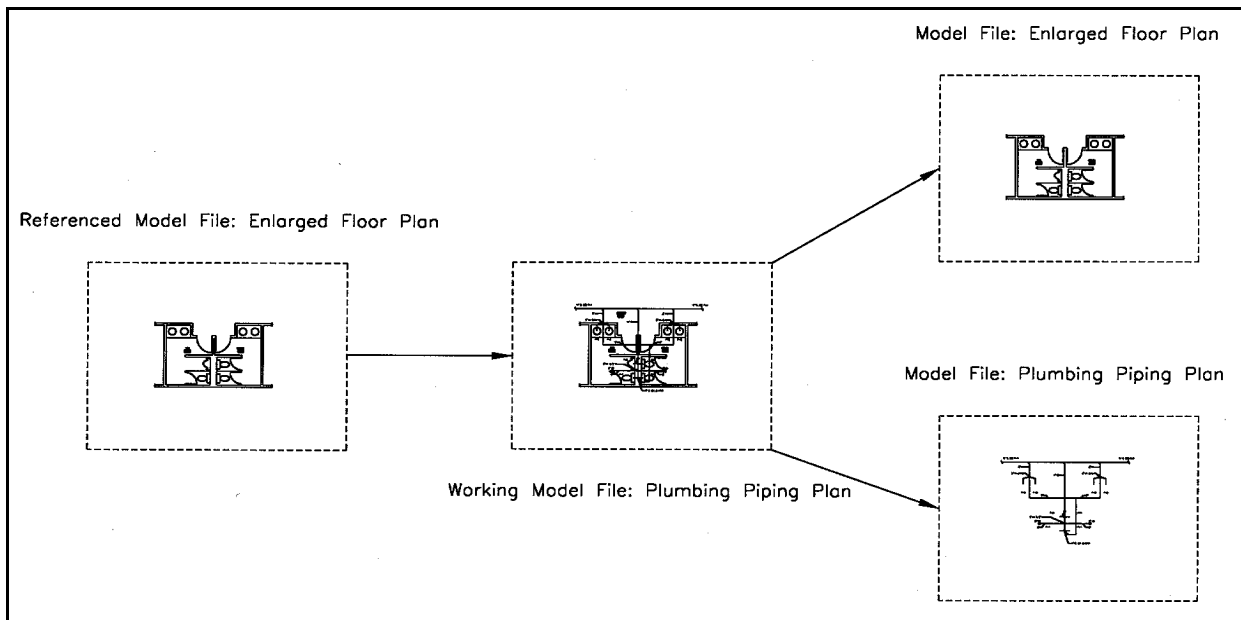

Figure 23. Using referenced model files to build a new model file without redundant effort

Discipline: Architectural							
Level #	Level/Layer Naming		Level/Layer Description	Graphics			
	AIA Format	ISO Format		Line Style	Line Width (mm)	AutoCAD Line Color/#	MicroStation Line Color
General Information							
1	A-ANNO-DIMS	A-----DIP-	Sheet-specific dimensions (includes witness/extension lines, dimension terminators, dimension text)	0	V	V	V
2	A-ANNO-KEYN	A-----KEP-	Sheet-specific reference keynotes with associated leaders	0	V	V	V
3	A-ANNO-LEGN	A-----LEP-	Legends and schedules	0	V	V	V
4	A-ANNO-PATT	A-----PAP-	Sheet-specific patterning, cross-hatching, poche (e.g., keyplan patterning)	0	0.18	Gr/8	Gr/9
5	A-ANNO-NOTE	A-----NOP-	Sheet-specific notes and general remarks	0	0.35	Y/2	Y/4
6	A-ANNO-SYMB	A-----SYP-	Sheet-specific symbols (e.g., scales, north arrow, section cuts, detail bubbles, etc.)	V	0.35	M/6	M/5
7	A-ANNO-TEXT	A-----TEP-	Sheet-specific text and callouts with associated leaders (e.g., title block text, legend and schedule text)	0	V	V	V
62	A-ANNO-REDL	A-----REP-	Redlines	0	0.25	R/1	R/3
63	A-ANNO-REVS	A-----RVP-	Revisions	0	0.50	C/4	C/7
NA	A-ANNO-REFR	A-----RFP-	Referenced model files (AutoCAD users only, see Chapter 4)	NA	NA	NA	NA

Figure 24. Sheet file level/layer assignment table

- The presentation graphics associated with each level/layer. This includes the line style, line width, and color.

Users should note that the first ten level/layers of the sheet file type for every discipline are the same, with the exception that the Discipline Designator changes depending on the discipline for that sheet file type. The unique function of these ten Annotation levels/layers is to contain sheet-specific information. These levels/layers are as follows with ** representing a Discipline Designator (e.g., A-, C-):

****ANNO-DIMS**

Sheet-specific witness/extension lines, dimension terminators, and dimension text.

****ANNO-KEYN**

Sheet-specific keynotes with associated leaders.

****ANNO-LEGN**

Legends and schedules.

****ANNO-NOTE**

Sheet-specific general notes and remarks.

****ANNO-PATT**

Sheet-specific patterning and hatching (e.g., keyplan patterning).

****ANNO-REDL**

Redlines, markups.

****ANNO-REVS**

Revisions, amendments, addenda, and modifications.

****ANNO-SYMB**

Sheet-specific symbols (e.g., north arrow, scales).

****ANNO-TEXT**

Sheet-specific text and callouts with associated leaders.

****ANNO-REFR**

An AutoCAD user-specific layer for use in attachment of external references (i.e., reference files).

Development of sheet files

As mentioned previously, referenced model files are used in the construction of sheet files. The user opens the sheet file type from Appendix B that is appropriate to his/her discipline then references existing model files.

As an example, in order to create a final Plumbing Plan sheet file (Figure 25), the engineer would first open/create a new sheet file.

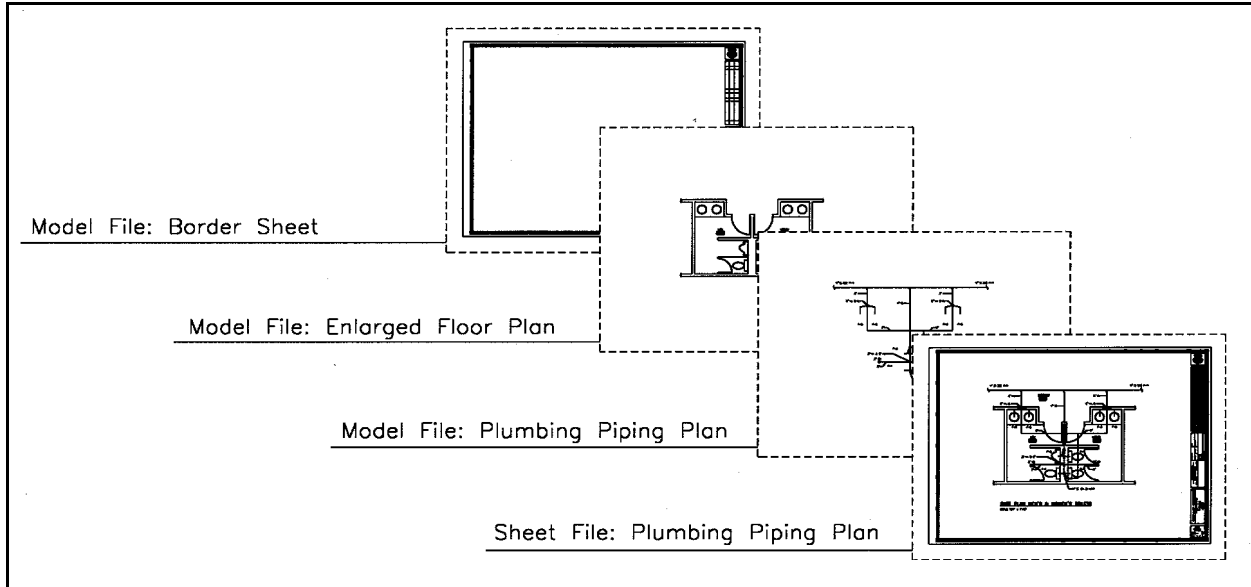

Figure 25. Using multiple referenced model files to build a sheet file without redundant effort

The engineer would reference various model files, such as the Architectural Floor Plan and the Plumbing Piping Plan. The engineer would have to "turn off" levels/layers within each referenced model file to achieve the desired sheet file. Then the Border Sheet model file would be referenced and scaled up to fit around the other referenced model files. Finally, the ten sheet file levels/layers such as P-ANNO-TEXT would be used to fill in sheet-specific information (e.g., sheet number, designer name). Once the final sheet file is achieved, the resulting file is saved (with all reference files attached).

5 Standard Symbology

Introduction

A “cell” in MicroStation and a “block” in AutoCAD are groups of graphical elements that can be manipulated as a single entity. Examples of typical cells/blocks are windows, doors, graphic scale keys, furniture, etc. The use of such symbology enhances CADD productivity and provides an excellent opportunity for CADD standardization.

Electronic Version of the Symbology/Elements

Deliverables

Within the electronic deliverables available as part of the A/E/C CADD Standard, the following symbology is provided (Figure 26):

- MicroStation cells contained in cell libraries (.cel) and custom line styles contained in resource files (.rsc).
- AutoCAD blocks, each in an individual drawing (.dwg) file, patterns in a pattern library file (.pat), multilines in a multiline library file (.mln), and custom line styles in a line type library file (.lin).

Line styles

Line style definitions determine the particular dash-dot sequence and relative length

of dashes, blank spaces, and the characteristics of any included text or shapes. Working with line styles provides a means of distinguishing the purpose of one line from another.

AutoCAD and MicroStation both provide a set of standard line styles, as well as allowing the user to define custom line styles. In AutoCAD these custom line styles are defined in a line type library file (.lin) and a multiline library file (.mln). In MicroStation, custom line styles are contained in resource files (.rsc) (see Chapter 3 “Line Types/Styles” for more information.

Note: *Custom line styles do not readily translate between systems; therefore users should anticipate that translated custom line styles may revert into their primitive graphics.*

Tabulated Version of the Symbology/Elements

Graphical presentations of the entire symbology library are shown in Appendix D “A/E/C CADD Symbology.”

The symbology library contains four types of elements: Lines, Patterns, Symbols, and Objects. Lines are defined as a graphical representation of linear drawing features (e.g., utility lines, fence lines, contours). Patterns are defined as repeated drawing elements (e.g., lines, dots, circles) within a defined area. Symbols are defined as MicroStation cells or AutoCAD blocks that are

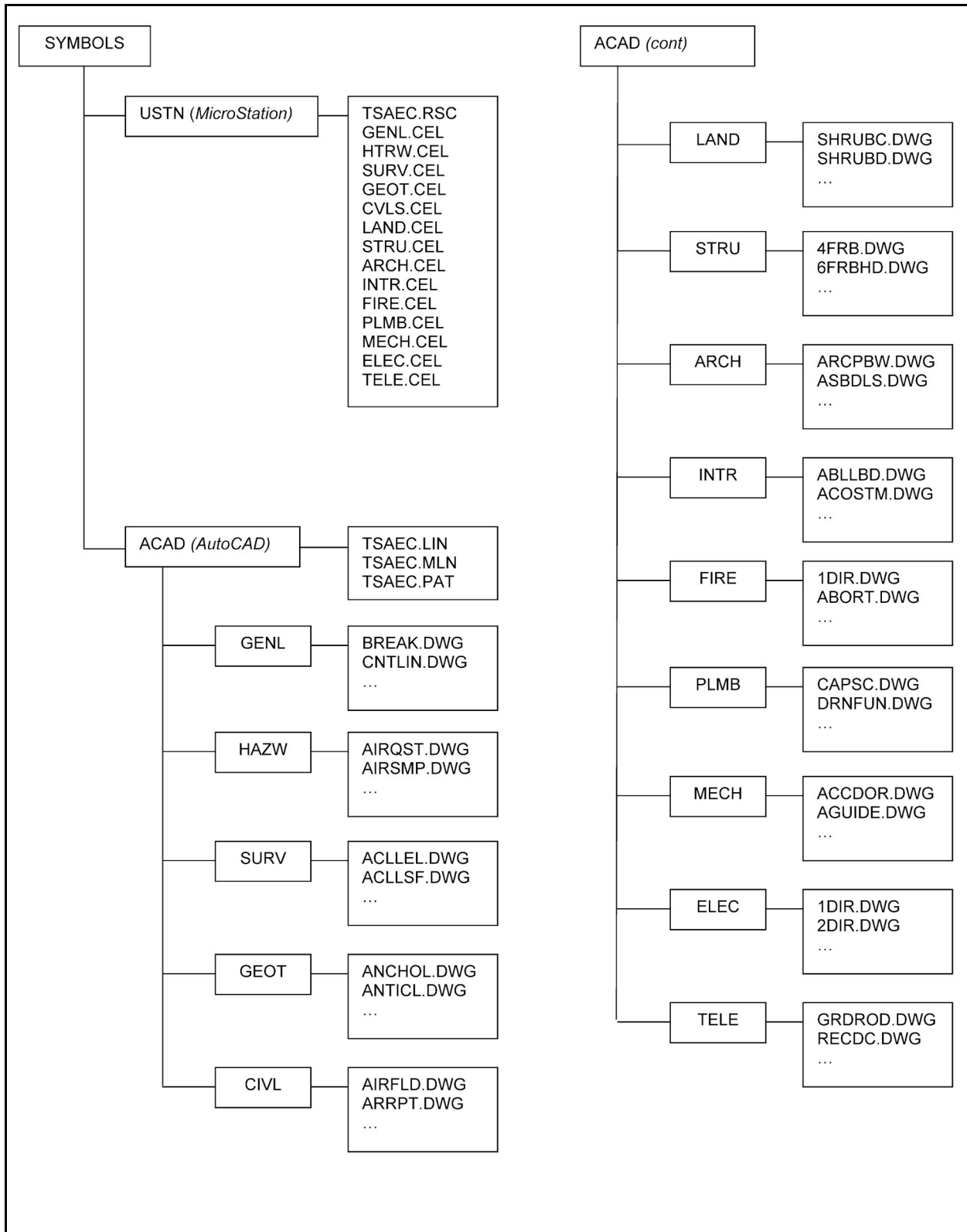

Figure 26. Symbology directory structure

representative of objects (e.g., electrical outlets, smoke detectors). Objects are defined as MicroStation cells or AutoCAD blocks that retain their actual size no matter the scale of the drawing (e.g., 30- by 50-in. desk, 3'-0" door).

Examples of the four element types are shown in Figures 27-30 and include the following information:

- **Name** - The name of the line type, pattern, symbol, or object. This is the name used when accessing the element with AutoCAD or MicroStation.
- **Description** - A brief explanation of what the symbol represents.
- **Element type** - The type of element that the symbology represents (i.e., line, pattern, symbol, or object).

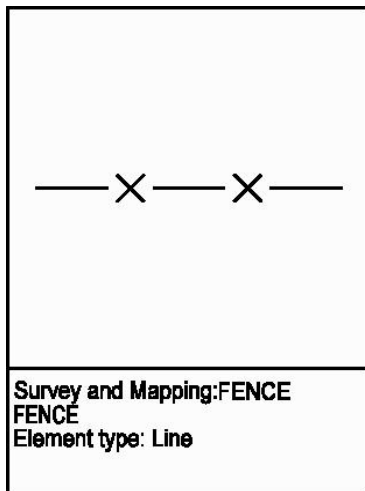

Figure 27. Line element

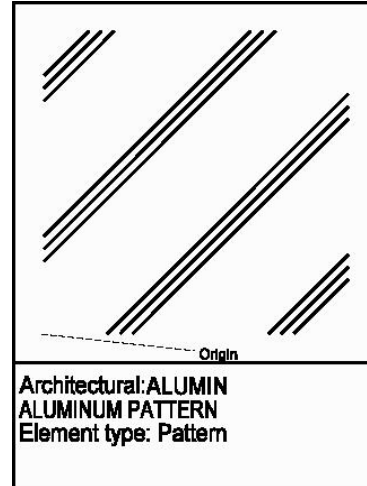

Figure 28. Pattern element

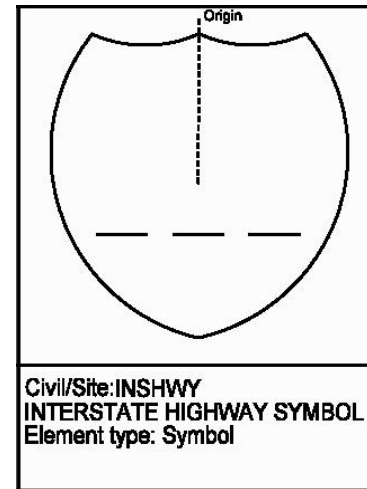

Figure 29. Symbol element

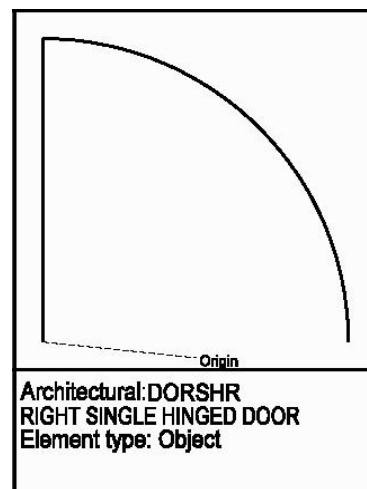

Figure 30. Object element

6 A/E/C CADD Standard Implementation Tools

CADD users throughout the DoD have indicated a need for customized shortcuts or utilities to facilitate efficient production of architectural and engineering CADD documents. Since the distribution of Release 1.4 of the A/E/C CADD Standard, users have been requesting tools to implement this detailed standard.

To meet this demand, the CADD/GIS Technology Center has developed applications for both AutoCAD and MicroStation that help in implementing the CADD Standard (i.e., the user will rarely have to refer to the standard document when developing CADD files).

The MicroStation-based tool (called Workspace) is distributed in three components: the Workspace generator, the Workspace itself, and a standard compliance checker. The generator creates the workspace tools (palettes, icons, etc.) using a Microsoft Access database that contains all the information within the model file tables in the CADD Standard. Using a “generator” gives system administrators the ability to edit the Access database and rerun the generator to create a Workspace that meets site-specific needs. The Workspace (Figure 31) allows the user to select the type of model or sheet file he/she wants to create (e.g., Architectural Floor Plan), and a palette of the various items that can be placed in that type of file is generated (e.g., doors, windows). The user then selects the specific type of item required (e.g., full height doors, partial height

doors, door symbols) and the workspace sets the proper level settings (e.g., level number, color, line weight, line style).

The final part of the workspace is the checker (Figure 32). The checker can evaluate individual model files to determine if they are in compliance with the A/E/C CADD Standard. The checker records which elements are not in compliance and can locate those elements for the user within the file.

The AutoCAD counterpart to the MicroStation A/E/C Workspace is also available. Using the same Access database as the MicroStation version, the AutoCAD A/E/C Workspace also assists the user in setting the correct drawing layer properties (Figure 33). The symbology in the A/E/C CADD Standard is also available for placement.

The Coast Guard is also adapting their CE-CADD software, which runs in AutoCAD, to follow the A/E/C CADD Standard. This product will be completed in the latter half of FY2001.

Further information on these implementation tools can be obtained from the CADD/GIS Technology Center web site at <http://tsc.wes.army.mil>.

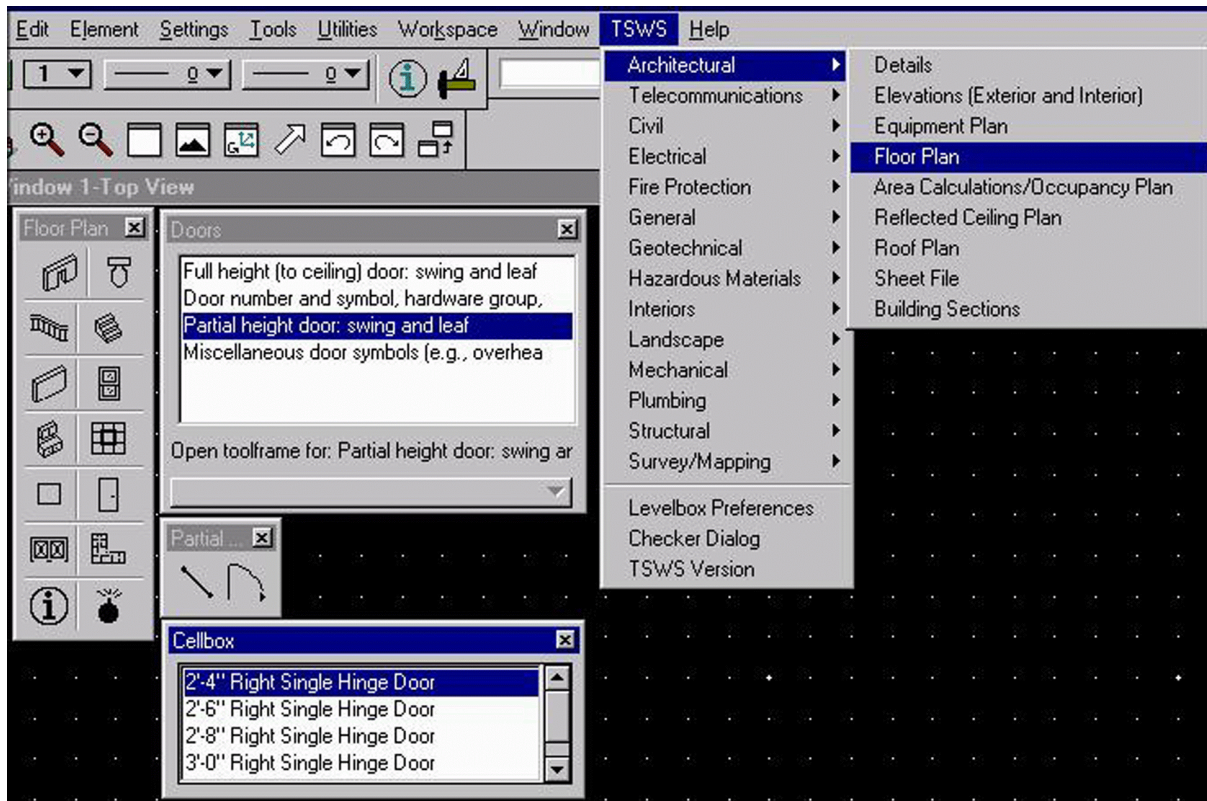

Figure 31. MicroStation workspace

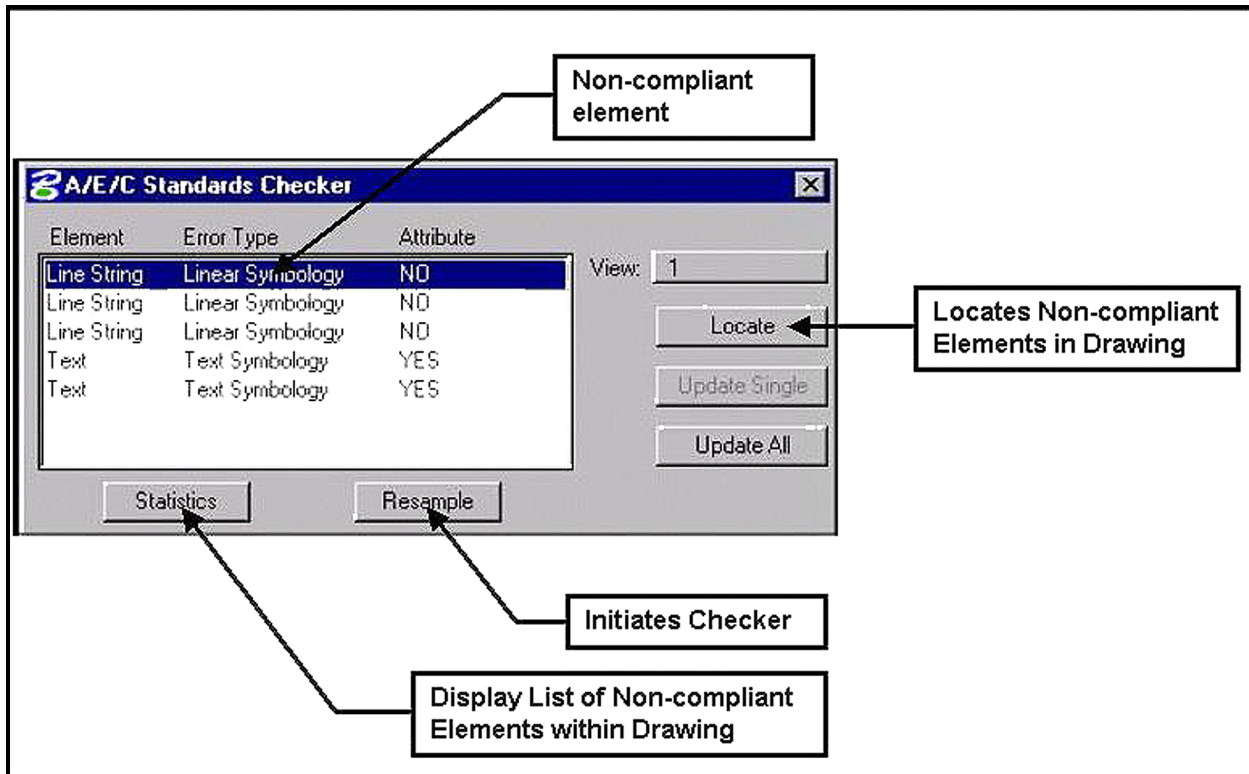

Figure 32. Workspace checker

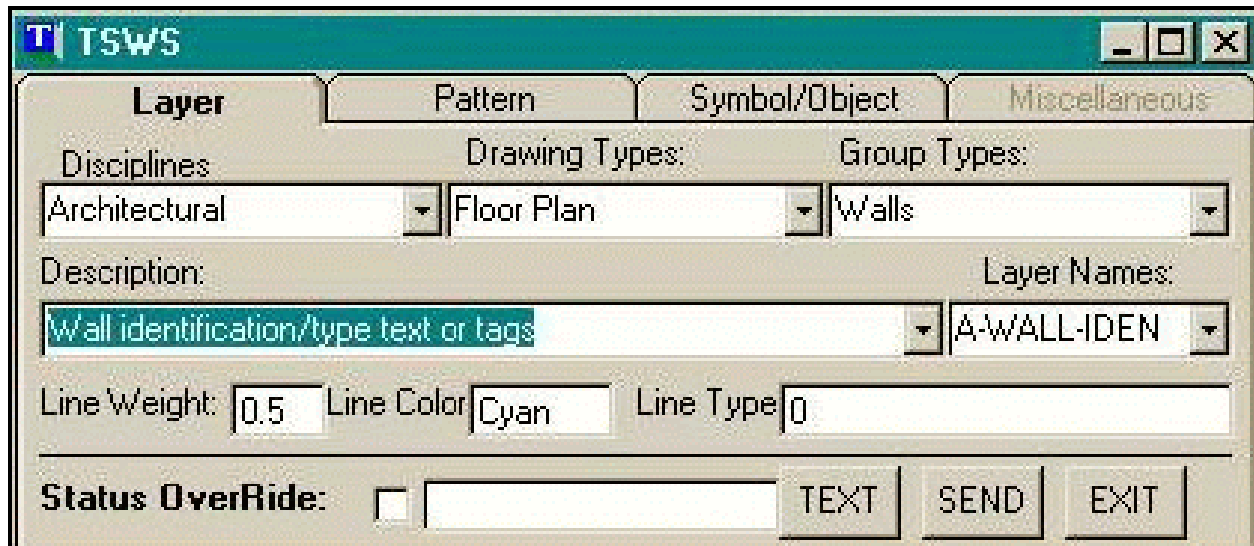

Figure 33. AutoCAD workspace

References

- American Institute of Architects. (1988). *Architectural graphic standards*. 8th ed., John Wiley and Sons, New York.
- American Institute of Architects. (2001). *AIA CAD layer guidelines: U.S. national CAD standard version 2*. American Institute of Architects Press, Washington, DC.
- American National Standard Institute. (1972). "Graphic symbols for electrical wiring and layout diagrams used in architect and building construction," ANSI Y32.9-1972, Institute of Electrical and Electronics Engineers, New York.
- American Society of Heating, Refrigerating and Air-Conditioning Engineers, Inc. (1997). "1997 ASHRAE fundamentals handbook," Atlanta, GA.
- American Society of Mechanical Engineers. (1995). "Decimal inch drawing sheet size and format," ASME Y14.1-1995, New York.
- _____. (1995). "Metric drawing sheet size and format," ASME Y14.1M-1995, New York.
- American Society of Plumbing Engineers. (1998). "Data book Volume 1: Fundamentals of plumbing engineering," Chicago, IL.
- American Society for Testing and Materials. (1999). "Standard practice for the use of metric (SI) units in building design and construction (Committee E-6 Supplement to E380)," ASTM E621-94, Philadelphia, PA.
- Construction Metrication Council. (1998). *Construction metrication*. Vol 7, Issue 1, National Institute of Building Sciences, Washington, DC.
- Construction Specifications Institute. (2001). *Uniform drawing system*. Alexandria, VA.
- Department of Commerce/Department of Defense. (1997). *United States of America nautical chart symbols, abbreviations, and terms*. 10th ed., Department of Commerce, Washington, DC.
- Headquarters, U. S. Army Corps of Engineers. (1990). "Standards manual for U. S. Army Corps of Engineers Computer-Aided Design and Drafting (CADD) systems," Engineer Manual 1110-1-1807, Washington, DC.

International Organization for Standardization. (1982). "Technical drawings - General principles of presentation," ISO 128, Switzerland.

_____. (1998). "Technical product documentation - Organization and naming of layers for CAD - Part 2: Concepts, format and codes used in construction documentation," ISO 13567-2, Switzerland.

National Fire Protection Association. (1999). "Standard for fire safety symbols," NFPA 170, Quincy, MA.

Sheet Metal and Air Conditioning Contractors' National Association. (1995). *HVAC duct construction standards-metal and flexible*. 2nd ed., Chantilly, VA.

The CADD/GIS Technology Center. (1999). "A/E/C CADD standard: Main text and appendices A-E," U.S. Army Engineer Research and Development Center, Vicksburg, MS.

_____. (2001). "Spatial data standards/facility management standards," Release 2.0, U.S. Army Engineer Research and Development Center, Vicksburg, MS.

Appendix A

Model File Level/Layer Assignment Tables

This appendix provides the model file level/layer assignment tables:

General

Border Sheet.....	A3
Keyplan.....	A4

Hazardous Materials

Pollution Prevention Plan.....	A5
Sections.....	A6
Details.....	A7

Survey/Mapping

Survey and Mapping Plan.....	A8
Hydrographic Survey and Mapping Plan.....	A10
Property Boundary.....	A11
Existing Electrical Utilities Plan.....	A12
Existing Communication Systems Plan.....	A13
Existing Domestic Water Plan.....	A14
Existing Sanitary Sewer Plan.....	A15
Existing Storm Sewer Plan.....	A16
Existing Industrial Waste Water Plan.....	A17
Existing Natural Gas Utilities Plan.....	A18
Existing Liquid Fuel Utilities Plan.....	A19
Existing HTCW Utilities Plan.....	A20
Existing Airfield Lighting Plan.....	A21
Existing Profiles.....	A22
Existing X-Sections.....	A23

Geotechnical

Boring Location Plan.....	A24
Boring Log.....	A25

Civil

Site Plan.....	A26
Grading Plan.....	A28
Dredging Plan.....	A29
Transportation Site Plan.....	A30
Joint Layout Plan.....	A31
Airfield Plan.....	A32
Airfield Pavement Marking Plan.....	A33
Domestic Water Plan.....	A34
Sanitary Sewer Plan.....	A35
Storm Sewer Plan.....	A36
Industrial Waste Water Plan.....	A37
Natural Gas Utilities Plan.....	A38
Liquid Fuel Utilities Plan.....	A39
Profiles.....	A40
Elevations.....	A41
X-Sections.....	A42
Details.....	A43

Landscape

Landscape Plan.....	A44
Irrigation Plan.....	A45
Details.....	A46

Structural

Foundation Plan.....	A47
Framing Plan.....	A48
Column Plan.....	A49
Non-Building Structures.....	A50
Elevations.....	A51
Sections.....	A52
Details.....	A53

Architectural

Floor Plan..... A54
 Reflected Ceiling Plan..... A56
 Roof Plan A57
 Equipment Plan..... A58
 Area Calculations/Occupancy Plan A59
 Elevations..... A60
 Sections A61
 Details A62

Interiors

Furniture Plan A63
 System Furniture Plan/Workstation
 Typicals A64
 Signage Placement Plan A65
 Elevations..... A66
 Details A67

Fire Protection

Life Safety Plan..... A68
 Fire Suppression Plan..... A69
 Fire Alarm/Detection Plan A70
 Details A71

Plumbing

Piping Plan..... A72
 Details A73
 Riser Diagrams..... A74

Mechanical

HVAC Plan..... A75
 Specialty Piping and Equipment Plan A77
 HTCW Plan..... A78
 Material Handling. A79
 Machine Design A80
 Elevations..... A81
 Sections A82
 Details A83
 Control Diagrams A84

Electrical

Lighting Plan..... A85
 Power Plan A86
 Special Systems Plan..... A87
 Grounding System Plan..... A89
 Electrical Utilities Plan..... A90
 Exterior Communication Systems Plan.. A92
 Airfield Lighting Plan A93
 Details A94
 Riser/One-Line Diagrams..... A95

Telecommunications

Telephone/Data Plan A96
 Riser Diagrams..... A97

Discipline: General

Model File Type: Border Sheet

Level #	Level/Layer Naming		Level/Layer Description	Graphics			
	AIA Format	ISO Format		Line Style	Line Width (mm)	AutoCAD Line Color#	MicroStation Line Color#
General Information							
6	G-ANNO-SYMB	G-----SYP-	Miscellaneous symbols	V	0.35	M/6	M/5
7	G-ANNO-TEXT	G-----TEP-	Miscellaneous text	0	V	V	V
10	G-ANNO-TTLB	G-----TTP-	Border and title block linework	0	V	V	V

Note: V = Varies, NA = Not Applicable

Discipline: General
Model File Type: Key Plan

Level #	Level/Layer Naming		Level/Layer Description	Graphics			
	AIA Format	ISO Format		Line Style	Line Width (mm)	AutoCAD Line Color/#	MicroStation Line Color/#
General Information							
3	G-ANNO-NPLT	G-----NPP-	Non-plotting graphic information	V	0.18	B/5	B/1
4	G-ANNO-PATT	G-----PAP-	Miscellaneous patterning and hatching	0	0.18	Gr/8	Gr/9
6	G-ANNO-SYMB	G-----SYP-	Miscellaneous symbols	V	0.35	M/6	M/5
7	G-ANNO-TEXT	G-----TEP-	Miscellaneous text and callouts with associated leaders	0	V	V	V
NA	G-ANNO-REFR	G-----RFP-	Reference files (AutoCAD users only, see Chapter 4)	NA	NA	NA	NA
Grid Lines							
11	G-GRID-EXTR	G-GRIDEXM-	Column grid outside building	7	0.18	B/5	B/1
12	G-GRID-IDEN	G-GRIDIDM-	Column grid tags	0	0.25	R/1	R/3
Floor Information							
15	G-PLAN-OTLN	G-PLANOTM-	Floor outline/perimeter/building footprint	0	0.35	M/6	M/5
Site Information							
20	G-SITE-OTLN	G-SITEOTM-	Site plan - key map	0	0.35	M/6	M/5

Note: V = Varies, NA = Not Applicable

Discipline: Hazardous Materials

Model File Type: Pollution Prevention Plan

Level #	Level/Layer Naming		Level/Layer Description	Graphics			
	AIA Format	ISO Format		Line Style	Line Width (mm)	AutoCAD Line Color#	MicroStation Line Color#
General Information							
1	H-ANNO-DIMS	H----DIP	Witness/extension lines, dimension terminators, dimension text	0	V	V	V
2	H-ANNO-KEYN	H----KEP-	Reference keynotes with associated leaders	0	V	V	V
3	H-ANNO-NPLT	H----NPP-	Non-plotting graphic information	V	0.18	B/5	B/1
4	H-ANNO-PATT	H----PAP-	Miscellaneous patterning and hatching	0	0.18	Gr/8	Gr/9
5	H-ANNO-NOTE	H----NOP-	General notes and general remarks	0	0.35	Y/2	Y/4
6	H-ANNO-SYMB	H----SYP-	Miscellaneous symbols	V	0.35	M/6	M/5
7	H-ANNO-TEXT	H----TEP-	Miscellaneous text and callouts with associated leaders	0	V	V	V
NA	H-ANNO-REFR	H----RFP-	Reference files (AutoCAD users only, see Chapter 4)	NA	NA	NA	NA
Buildings							
11	H-BLDG-IDEN	H-BLDGIDM-	Annotation	0	0.35	Y/2	Y/4
12	H-BLDG-OTLN	H-BLDGOTM-	Command posts, information centers	0	0.35	Y/2	Y/4
Storage Facilities							
13	H-STOR-HAZM	H-STORHMM-	Hazardous materials	0	0.35	M/6	M/5
14	H-STOR-HAZW	H-STORHWM-	Hazardous waste	0	0.35	M/6	M/5
15	H-STOR-IDEN	H-STORIDM-	Annotation	0	0.35	M/6	M/5
Monitoring Stations							
17	H-MNST-GWTR	H-MNSTGWM-	Ground water	0	0.25	G/3	G/2
18	H-MNST-SWTR	H-MNSTSWM-	Surface water	0	0.25	G/3	G/2
19	H-MNST-AIRQ	H-MNSTAIM-	Air quality	0	0.25	G/3	G/2
20	H-MNST-SOIL	H-MNSTSOM-	Soil gas	0	0.25	G/3	G/2
21	H-MNST-LAND	H-MNSTLAM-	Landfill gas	0	0.25	G/3	G/2
22	H-MNST-IDEN	H-MNSTIDM-	Annotation	0	0.25	G/3	G/2
Pollution Areas							
23	H-POLL-ORIG	H-POLLORM-	Point of pollution origin	0	0.35	Y/2	Y/4
24	H-POLL-CONC	H-POLLCOM-	Polluted area of concern	0	0.35	Y/2	Y/4
25	H-POLL-POTN	H-POLLPOM-	Potential spill, emission, or release source	0	0.35	Y/2	Y/4
26	H-POLL-IDEN	H-POLLIDM-	Annotation	0	0.35	Y/2	Y/4
Decontamination							
29	H-DECN-EQPM	H-DECNEQM-	Decontamination equipment	0	0.25	R/1	R/3
30	H-DECN-IDEN	H-DECNIDM-	Annotation	0	0.35	M/6	M/5
Emergency Fixtures							
31	H-FIXT-EYEW	H-FIXTEYM-	Emergency eyewashes	0	0.25	G/3	G/2
32	H-FIXT-SHOW	H-FIXTSHM-	Emergency showers	0	0.25	G/3	G/2
Disposal Areas							
34	H-DISP-HAZW	H-DISPHWM-	Hazardous waste	0	0.18	B/5	B/1
35	H-DISP-MUNT	H-DISPMUM-	Munitions	0	0.18	B/5	B/1
36	H-DISP-TANK	H-DISPTAM-	Spill containment tanks	0	0.35	M/6	M/5
37	H-DISP-IDEN	H-DISPIDM-	Annotation	0	0.35	M/6	M/5
Sample Points							
39	H-SAMP-AIRS	H-SAMPAIM-	Air samples	0	0.25	R/1	R/3
40	H-SAMP-BIOL	H-SAMPBIM-	Biological samples	0	0.25	R/1	R/3
41	H-SAMP-GWTR	H-SAMPGWM-	Ground water samples	0	0.25	R/1	R/3
42	H-SAMP-SEDI	H-SAMPSEM-	Sediment samples	0	0.25	R/1	R/3
43	H-SAMP-SOIL	H-SAMPSEM-	Soil samples	0	0.25	R/1	R/3
44	H-SAMP-SOLI	H-SAMPSLM-	Solid material samples	0	0.25	R/1	R/3
45	H-SAMP-SWTR	H-SAMPSSWM-	Surface water samples	0	0.25	R/1	R/3
46	H-SAMP-WAST	H-SAMPWAM-	Waste samples	0	0.25	R/1	R/3
47	H-SAMP-MAGN	H-SAMPMAM-	Magnetometer location points	0	0.25	R/1	R/3
48	H-SAMP-IDEN	H-SAMPIDM-	Annotation	0	0.25	R/1	R/3
Demolition (used only in creating Existing/Demolition model files)							
56	H-STAT-DEMO-PHS1	H-----M-D---1	Demolition - phase 1	0	0.50	203	45
57	H-STAT-DEMO-PHS2	H-----M-D---2	Demolition - phase 2	0	0.50	83	42
58	H-STAT-DEMO-PHS3	H-----M-D---3	Demolition - phase 3	0	0.50	163	41

Note: V = Varies, NA = Not Applicable

Discipline: Hazardous Materials

Model File Type: Sections

Level #	Level/Layer Naming		Level/Layer Description	Graphics			
	AIA Format	ISO Format		Line Style	Line Width (mm)	AutoCAD Line Color/#	MicroStation Line Color/#
General Information							
1	H-ANNO-DIMS	H-----DIP-	Witness/extension lines, dimension terminators, dimension text	0	V	V	V
2	H-ANNO-KEYN	H-----KEP-	Reference keynotes with associated leaders	0	V	V	V
3	H-ANNO-NPLT	H-----NPP-	Non-plotting graphic information	V	0.18	B/5	B/1
4	H-ANNO-PATT	H-----PAP-	Miscellaneous patterning and hatching	0	0.18	Gr/8	Gr/9
5	H-ANNO-NOTE	H-----NOP-	General notes and general remarks	0	0.35	Y/2	Y/4
6	H-ANNO-SYMB	H-----SYP-	Miscellaneous symbols	V	0.35	M/6	M/5
7	H-ANNO-TEXT	H-----TEP-	Miscellaneous text and callouts with associated leaders	0	V	V	V
NA	H-ANNO-REFR	H-----RFP-	Reference files (AutoCAD users only, see Chapter 4)	NA	NA	NA	NA
Sections							
45	H-SECT-IDEN	H-SECTIDM-	Component identification numbers	0	0.35	Y/2	Y/4
46	H-SECT-MBND	H-SECTMBM-	Material beyond section cut	0	0.18	B/5	B/1
47	H-SECT-MCUT	H-SECTMCM-	Material cut by section	0	0.50	C/4	C/7
48	H-SECT-PATT	H-SECTPAM-	Textures and hatch patterns	0	0.18	Gr/8	Gr/9
Demolition (used only in creating Existing/Demolition model files)							
56	H-STAT-DEMO-PHS1	H-----M-D----1	Demolition - phase 1	0	0.50	203	45
57	H-STAT-DEMO-PHS2	H-----M-D----2	Demolition - phase 2	0	0.50	83	42
58	H-STAT-DEMO-PHS3	H-----M-D----3	Demolition - phase 3	0	0.50	163	41

Note: V = Varies, NA = Not Applicable

Discipline: Hazardous Materials

Model File Type: Details

Level #	Level/Layer Naming		Level/Layer Description	Graphics			
	AIA Format	ISO Format		Line Style	Line Width (mm)	AutoCAD Line Color/#	MicroStation Line Color/#
General Information							
1	H-ANNO-DIMS	H-----DIP-	Witness/extension lines, dimension terminators, dimension text	0	V	V	V
2	H-ANNO-KEYN	H-----KEP-	Reference keynotes with associated leaders	0	V	V	V
3	H-ANNO-NPLT	H-----NPP-	Non-plotting graphic information	V	0.18	B/5	B/1
4	H-ANNO-PATT	H-----PAP-	Miscellaneous patterning	0	0.18	Gr/8	Gr/9
6	H-ANNO-SYMB	H-----SYP-	Reference bubbles, matchlines and breaklines	V	0.35	M/6	M/5
7	H-ANNO-TEXT	H-----TEP-	Detail title text, text and associated leaders, notes	V	V	V	V
Detail Information							
11	H-DETL-GRPH	H-DETLGRM-	Graphics, gridlines, non-text items	V	V	V	V
12	H-DETL-METR	H-DETLMEM-	Metric-specific dimensions and notes	0	0.25	G/3	G/2
13	H-DETL-INPD	H-DETLINM-	Inch-pound-specific dimensions and notes	0	0.25	R/1	R/3
Demolition (used only in creating Existing/Demolition model files)							
56	H-STAT-DEMO-PHS1	H-----M-D----1	Demolition - phase 1	0	0.50	203	45
57	H-STAT-DEMO-PHS2	H-----M-D----2	Demolition - phase 2	0	0.50	83	42
58	H-STAT-DEMO-PHS3	H-----M-D----3	Demolition - phase 3	0	0.50	163	41

Note: V = Varies, NA = Not Applicable

Discipline: Survey/Mapping

Model File Type: Survey and Mapping Plan

Level #	Level/Layer Naming		Level/Layer Description	Graphics			
	AIA Format	ISO Format		Line Style	Line Width (mm)	AutoCAD Line Color#	MicroStation Line Color#
General Information							
1	V-ANNO-DIMS	V-----DIP-	Witness/extension lines, dimension terminators, dimension text	0	V	V	V
2	V-ANNO-KEYN	V-----KEP-	Reference keynotes with associated leaders	0	V	V	V
3	V-ANNO-NPLT	V-----NPP-	Non-plotting graphic information	V	0.18	B/5	B/1
4	V-ANNO-PATT	V-----PAP-	Miscellaneous patterning and hatching	0	0.18	Gr/8	Gr/9
5	V-ANNO-NOTE	V-----NOP-	General notes and general remarks	0	0.35	Y/2	Y/4
6	V-ANNO-SYMB	V-----SYP-	Miscellaneous symbols	V	0.35	M/6	M/5
7	V-ANNO-TEXT	V-----TEP-	Miscellaneous text and callouts with associated leaders	0	V	V	V
NA	V-ANNO-REFR	V-----RFP-	Reference files (AutoCAD users only, see Chapter 4)	NA	NA	NA	NA
Survey Lines							
8	V-SURV-DATA	V-SURVDAM-	Survey data (benchmarks and horizontal control points or monuments)	0	0.35	M/6	M/5
9	V-SURV-LINE	V-SURVLIM-	Survey, baseline, and control line	2	0.50	C/4	C/7
10	V-SURV-IDEN	V-SURVIDM-	Survey, baseline, and control line annotator	0	0.35	M/6	M/5
Buildings and Structures							
11	V-BLDG-OTLN	V-BLDGOTM-	Buildings and other structures	0	0.70	W/7	W/0
12	V-BLDG-IDEN	V-BLDGIDM-	Building and other structure annotator	0	0.35	Y/2	Y/4
Site							
13	V-SITE-FENC	V-SITEFEM-	Fences and handrails	0, FENCE	0.35	M/6	M/5
14	V-SITE-FENC-IDEN	V-SITEFIM-	Fence, handrail, ramp, and trail annotation	0	0.35	M/6	M/5
15	V-SITE-STRC	V-SITESRM-	Structures (bridges, sheds, foundation pads, footings, etc.)	0	0.35	22	22
16	V-SITE-IDEN	V-SITEIDM-	Existing site feature/structure annotation	0	0.35	M/6	M/5
17	V-SITE-OTLN	V-SITEOTM-	Existing site features (play structures, bike racks, benches, recreational equipment)	0	0.50	C/4	C/7
18	V-SITE-EROS	V-SITEERM-	Riprap, revetments/stone protection, breakwaters, dikes, jetties, and drains	0	0.25	R/1	R/3
19	V-SITE-EWAT	V-SITEEWM-	Water features	0	0.35	162	33
20	V-SITE-STRS	V-SITESTM-	Stairs and ramps	0	0.35	M/6	M/5
21	V-SITE-WALK	V-SITEWAM-	Walks, trails, and bicycle paths	0	0.35	Y/2	Y/4
22	V-SITE-VEGE	V-SITEVEM-	Existing treelines and vegetation	0, TREEL	0.35	82	18
Utilities (for more detailed surveys, use Survey and Mapping Utility model files)							
23	V-UTIL-SSWR	V-UTILSSM-	Sanitary lines and manholes	0, SSWAFX	0.50	C/4	C/7
24	V-UTIL-SSWR-IDEN	V-UTILSDM-	Sanitary annotation	0	0.35	Y/2	Y/4
25	V-UTIL-WATR	V-UTILWAM-	Water lines, hydrants, tanks	0, WATRX	0.50	C/4	C/7
26	V-UTIL-WATR-IDEN	V-UTILWIM-	Water annotation	0	0.35	Y/2	Y/4
27	V-UTIL-NGAS	V-UTILNGM-	Gas lines, features, and valves	0, NTGASX	0.50	C/4	C/7
28	V-UTIL-NGAS-IDEN	V-UTILNIM-	Gas annotation	0	0.35	Y/2	Y/4
29	V-UTIL-STEM	V-UTILSEM-	Steam lines and annotation	0	0.35	Y/2	Y/4
30	V-UTIL-STRM	V-UTILSTM-	Storm sewer lines, culverts, manholes, and headwalls	0, STRAFX, CULVRT	0.50	C/4	C/7
31	V-UTIL-STRM-IDEN	V-UTILSIM-	Storm sewer annotation	0	0.35	Y/2	Y/4
32	V-UTIL-ELEC	V-UTILELM-	Power lines, lights, telephone poles, communication lines	0, COMARX, COMUGX, EPARX, EPUGX, ESARX, ESUGX	0.50	C/4	C/7
33	V-UTIL-ELEC-IDEN	V-UTILEIM-	Power/communication annotator	0	0.35	Y/2	Y/4
Pavements/Transportation							
34	V-PVMT-ROAD	V-PVMTROM-	Roads, parking lots, railroads, airfield pavements	0, RAILS	0.35	Y/2	Y/4
35	V-PVMT-IDEN	V-PVMTIDM-	Road, parking lot, railroad, airfield pavement annotation	0	0.35	Y/2	Y/4
36	V-PVMT-PATT	V-PVMTSAM-	Joint patterns, text and dimensions	0	0.35	Y/2	Y/4
37	V-PVMT-MRKG	V-PVMTMRM-	Pavement markings and signs	0	0.35	Y/2	Y/4

Discipline: Survey/Mapping

Model File Type: Survey and Mapping Plan

Topography							
38	V-TOPO-DTCH	V-TOPODTM-	Ditches and swales	0, DITCH	0.25	G/3	G/2
39	V-TOPO-BORE	V-TOPOBOM-	Boring locations	0	0.35	M/6	M/5
40	V-TOPO-COOR	V-TOPOCOM-	Coordinate grid ticks and text	0	0.35	122	23
41	V-TOPO-MAJR-IDEN	V-TOPOMAM-	Major contours - annotation	0	0.35	Y/2	Y/4
42	V-TOPO-MAJR	V-TOPOMJM-	Major contours	0	0.35	Y/2	Y/4
43	V-TOPO-MINR-IDEN	V-TOPOMIM-	Minor contours - annotation	0	0.25	G/3	G/2
44	V-TOPO-MINR	V-TOPOMNM-	Minor contours	0	0.25	G/3	G/2
48	V-TOPO-SPOT	V-TOPOSPM-	Spot elevations	0	0.35	Y/2	Y/4
49	V-TOPO-SLOP-TOPT	V-TOPOSTM-	Top/toe slopes	0	0.35	M/6	M/5
50	V-TOPO-BKLN	V-TOPOBKM-	Breaklines	4	0.70	W/7	W/0
51	V-TOPO-DTMT	V-TOPODTM-	DTM triangles	0	0.35	22	22
52	V-TOPO-DTMP	V-TOPODPM-	DTM points	0	0.35	M/6	M/5
Aerial Survey							
53	V-AERI-PATH	V-AERIPAM-	Aerial flight lines/paths	11	0.35	22	22
54	V-AERI-BNDY	V-AERIBNM-	Aerial photography boundaries	0	0.35	M/6	M/5
55	V-AERI-INDX	V-AERIINM-	Aerial photo index	0	0.70	W/7	W/0

Note: V = Varies, NA = Not Applicable

Discipline: Survey/Mapping

Model File Type: Hydrographic Survey and Mapping Plan

Level #	Level/Layer Naming		Level/Layer Description	Graphics			
	AIA Format	ISO Format		Line Style	Line Width (mm)	AutoCAD Line Color/#	MicroStation Line Color/#
General Information							
1	V-ANNO-DIMS	V-----DIP-	Witness/extension lines, dimension terminators, dimension text	0	V	V	V
2	V-ANNO-KEYN	V-----KEP-	Reference keynotes with associated leaders	0	V	V	V
3	V-ANNO-NPLT	V-----NPP-	Non-plotting graphic information	V	0.18	B/5	B/1
4	V-ANNO-PATT	V-----PAP-	Miscellaneous patterning and hatching	0	0.18	Gr/8	Gr/9
5	V-ANNO-NOTE	V-----NOP-	General notes and general remarks	0	0.35	Y/2	Y/4
6	V-ANNO-SYMB	V-----SYP-	Miscellaneous symbols	V	0.35	M/6	M/5
7	V-ANNO-TEXT	V-----TEP-	Miscellaneous text and callouts with associated leaders	0	V	V	V
NA	V-ANNO-REFR	V-----RFP-	Reference files (AutoCAD users only, see Chapter 4)	NA	NA	NA	NA
Survey Lines							
8	V-SURV-DATA	V-SURVDAM-	Survey data (benchmarks and horizontal control points or monuments)	0	0.35	M/6	M/5
9	V-SURV-LINE	V-SURVLIM-	Survey, baseline, and control lines	2	0.50	C/4	C/7
10	V-SURV-IDEN	V-SURVIDM-	Survey, baseline, and control line annotator	0	0.35	M/6	M/5
Structures							
11	V-STRC-OTLN	V-STRCOTM-	Bridges, piers, breakwaters, docks, floats, etc. - outlines	0	0.50	C/4	C/7
12	V-STRC-IDEN	V-STRCIDM-	Bridges, piers, breakwaters, docks, floats, etc. - annotator	0	0.35	Y/2	Y/4
Channels							
14	V-CHAN-LIMT	V-CHANLIM-	Channel limits, anchorages, turning basins, disposal areas, etc.	0	0.35	M/6	M/5
15	V-CHAN-IDEN	V-CHANIDM-	Channel limits, anchorages, turning basins, disposal areas, etc. - annotation	0	0.35	M/6	M/5
16	V-CHAN-DACL	V-CHANDAM-	De-authorized channel limits, anchorages, etc.	0	0.25	G/3	G/2
17	V-CHAN-DACL-IDEN	V-CHANDIM-	De-authorized channel limits, anchorages, etc. - annotation	0	0.25	G/3	G/2
18	V-CHAN-CNTR	V-CHANCNM-	Channel centerline and survey report lines	4	0.18	B/5	B/1
19	V-CHAN-CNTR-IDEN	V-CHANCIM-	Channel centerline and survey report lines - annotation	0	0.18	B/5	B/1
20	V-CHAN-AIDS	V-CHANAIM-	Navigation aids and text	0	0.35	Y/2	Y/4
Topography							
39	V-TOPO-BORE	V-TOPOBOM-	Boring locations	0	0.35	M/6	M/5
40	V-TOPO-COOR	V-TOPOCOM-	Coordinate grid ticks and text	0	0.35	122	23
41	V-TOPO-MAJR-IDEN	V-TOPOMAM-	Major contours - annotation	0	0.35	Y/2	Y/4
42	V-TOPO-MAJR	V-TOPOMJM-	Major contours	0	0.35	Y/2	Y/4
43	V-TOPO-MINR-IDEN	V-TOPOMIM-	Minor contours - annotation	0	0.25	G/3	G/2
44	V-TOPO-MINR	V-TOPOMNM-	Minor contours	0	0.25	G/3	G/2
45	V-TOPO-SHOR	V-TOPOSHM-	Shorelines, land features, and references	0	0.50	C/4	C/7
49	V-TOPO-SOUN	V-TOPOSOM-	Soundings	0	0.18	V	V

Note: V = Varies, NA = Not Applicable

Discipline: Survey/Mapping
Model File Type: Property Boundary

Level #	Level/Layer Naming		Level/Layer Description	Graphics			
	AIA Format	ISO Format		Line Style	Line Width (mm)	AutoCAD Line Color#	MicroStation Line Color#
General Information							
1	V-ANNO-DIMS	V-----DIP-	Witness/extension lines, dimension terminators, dimension text	0	V	V	V
2	V-ANNO-KEYN	V-----KEP-	Reference keynotes with associated leaders	0	V	V	V
3	V-ANNO-NPLT	V-----NPP-	Non-plotting graphic information	V	0.18	B/5	B/1
4	V-ANNO-PATT	V-----PAP-	Miscellaneous patterning and hatching	0	0.18	Gr/8	Gr/9
5	V-ANNO-NOTE	V-----NOP-	General notes and general remarks	0	0.35	Y/2	Y/4
6	V-ANNO-SYMB	V-----SYP-	Miscellaneous symbols	V	0.35	M/6	M/5
7	V-ANNO-TEXT	V-----TEP-	Miscellaneous text and callouts with associated leaders	0	V	V	V
NA	V-ANNO-REFR	V-----RFP-	Reference files (AutoCAD users only, see Chapter 4)	NA	NA	NA	NA
Survey Lines							
8	V-SURV-DATA	V-SURVDAM-	Survey data and benchmarks (PI, PT, etc information)	0	0.35	M/6	M/5
9	V-SURV-LINE	V-SURVLIM-	Survey and control line	2	0.50	C/4	C/7
10	V-SURV-IDEN	V-SURVIDM-	Survey and control line annotator	0	0.35	M/6	M/5
Buildings and Structures							
11	V-BLDG-OTLN	V-BLDGOTM-	Buildings and other structures	0	0.35	Y/2	Y/4
12	V-BLDG-IDEN	V-BLDGIDM-	Building and other structure annotator	0	0.50	C/4	C/7
Site							
13	V-SITE-FENC	V-SITEFEM-	Fences and handrails	0, FENCE	0.35	M/6	M/5
14	V-SITE-FENC-IDEN	V-SITEFIM-	Fence, handrail, ramp, sign, and trail annotation	0	0.35	M/6	M/5
15	V-SITE-STRC	V-SITESRM-	Structures (bridges, sheds, foundation pads, footings, etc.)	0	0.35	22	22
16	V-SITE-IDEN	V-SITEIDM-	Existing site feature/structure annotation	0	0.35	M/6	M/5
17	V-SITE-OTLN	V-SITEOTM-	Existing site features (play structures, bike racks, benches, recreational equipment)	0	0.50	C/4	C/7
18	V-SITE-EROS	V-SITEERM-	Riprap, revetments/stone protection, breakwaters, dikes, jetties, and drains	0	0.25	R/1	R/3
19	V-SITE-EWAT	V-SITEEWM-	Water features	0	0.35	162	33
20	V-SITE-STRS	V-SITESTM-	Stairs and ramps	0	0.35	M/6	M/5
21	V-SITE-WALK	V-SITEWAM-	Walks, trails, and bicycle paths	0	0.35	Y/2	Y/4
22	V-SITE-VEGE	V-SITEVEM-	Existing treelines and vegetation	0, TREEL	0.35	82	18
Property							
22	V-PROP-SECT	V-PROPSEM-	Section lines	7	0.35	M/6	M/5
23	V-PROP-QTRS	V-PROPQTM-	Quarter lines	11	0.35	M/6	M/5
24	V-PROP-BRNG	V-PROPB RM-	Bearings and distance labels	0	0.35	M/6	M/5
25	V-PROP-ESMT	V-PROPE SM-	Government easements/property lines	0	0.50	C/4	C/7
26	V-PROP-LINE	V-PROPLIM-	Property lines (Existing recorded plats)	3	0.35	Y/2	Y/4
27	V-PROP-RWAY	V-PROPRWM-	Right of ways	RTOFWY	0.70	W/7	W/0
28	V-PROP-IDEN	V-PROPIDM-	Property annotation	0	0.35	M/6	M/5
29	V-PROP-SXTS	V-PROPSXM-	Sixteenth lines (40 lines)	16THLN	0.35	M/6	M/5
Utilities							
30	V-UTIL-LINE	V-UTILLIM-	Utilities	V	0.50	C/4	C/7
31	V-UTIL-IDEN	V-UTILIDM-	Utility annotation	0	0.35	Y/2	Y/4
Pavements/Transportation							
34	V-PVMT-ROAD	V-PVMTROM-	Roads, parking lots, railroads, airfield pavements	0, RAILS	0.35	Y/2	Y/4
35	V-PVMT-IDEN	V-PVMTIDM-	Road, parking lot, railroad, airfield pavement annotation	0	0.35	Y/2	Y/4
37	V-PVMT-MRKG	V-PVMTMRM-	Signs	0	0.35	Y/2	Y/4

Note: V = Varies, NA = Not Applicable

Discipline: Survey/Mapping

Model File Type: Existing Electrical Utilities Plan

Level #	Level/Layer Naming		Level/Layer Description	Graphics			
	AIA Format	ISO Format		Line Style	Line Width (mm)	AutoCAD Line Color/#	MicroStation Line Color/#
General Information							
1	V-ANNO-DIMS	V-----DIP-	Witness/extension lines, dimension terminators, dimension text	0	V	V	V
2	V-ANNO-KEYN	V-----KEP-	Reference keynotes with associated leaders	0	V	V	V
3	V-ANNO-NPLT	V-----NPP-	Non-plotting graphic information	V	0.18	B/5	B/1
4	V-ANNO-PATT	V-----PAP-	Miscellaneous patterning and hatching	0	0.18	Gr/8	Gr/9
5	V-ANNO-NOTE	V-----NOP-	General notes and general remarks	0	0.35	Y/2	Y/4
6	V-ANNO-SYMB	V-----SYP-	Miscellaneous symbols	V	0.35	M/6	M/5
7	V-ANNO-TEXT	V-----TEP-	Miscellaneous text and callouts with associated leaders	0	V	V	V
NA	V-ANNO-REFR	V-----RFP-	Reference files (AutoCAD users only, see Chapter 4)	NA	NA	NA	NA
Primary Electrical Cables							
11	V-PRIM-OVHD	V-PRIMOVM-	Overhead electrical utility lines	EPARX	0.25	R/1	R/3
12	V-PRIM-OVHD-IDEN	V-PRIMOIM-	Identifier tags, symbol modifier, and text	0	0.25	R/1	R/3
13	V-PRIM-UNDR	V-PRIMUNM-	Underground electrical utility lines	EPUGX	0.25	R/1	R/3
14	V-PRIM-UNDR-IDEN	V-PRIMUIM-	Identifier tags, symbol modifier, and text	0	0.25	R/1	R/3
Secondary Electrical Cables							
15	V-SECD-OVHD	V-SECDOVM-	Overhead electrical utility lines	ESARX	0.25	61	108
16	V-SECD-OVHD-IDEN	V-SECDOIM-	Identifier tags, symbol modifier, and text	0	0.25	61	108
17	V-SECD-UNDR	V-SECDUNM-	Underground electrical utility lines	ESUGX	0.25	61	108
18	V-SECD-UNDR-IDEN	V-SECDUIM-	Identifier tags, symbol modifier, and text	0	0.25	61	108
Transformers							
19	V-TRAN-PADM	V-TRANPAM-	Pad mounted transformers	0	0.25	21	30
20	V-TRAN-PADM-IDEN	V-TRANPAM-	Identifier tags, symbol modifier, and text	0	0.25	21	30
21	V-TRAN-POLE	V-TRANPOM-	Pole mounted transformers	0	0.25	21	30
22	V-TRAN-POLE-IDEN	V-TRANPIM-	Identifier tags, symbol modifier, and text	0	0.25	21	30
Electrical Support Equipment							
23	V-ELEC-JBOX	V-ELECBJM-	Junction boxes, pull boxes, manholes, handholes, pedestals, splices	0	0.25	21	30
24	V-ELEC-DEVC	V-ELECDM-	Capacitors, voltage regulators, motors, buses, generators, meters, grounds, and markers	0	0.25	21	30
25	V-ELEC-SWCH	V-ELECSWM-	Fuse cutouts, pole mounted switches, circuit breakers, gang operated disconnects, reclosers, cubicle switches	0	0.25	21	30
26	V-ELEC-SUBS	V-ELECSUM-	Other substation equipment	0	0.25	21	30
Lights							
31	V-LITE-FIXT	V-LITEFXM-	Exterior Lights	0	0.25	121	15
32	V-LITE-FIXT-IDEN	V-LITEFIM-	Identifier tags, symbol modifier, and text	0	0.25	121	15
Utility Poles							
33	V-POLE-UTIL	V-POLEUTM-	Utility poles	0	0.25	G/3	G/2
34	V-POLE-IDEN	V-POLEUIM-	Utility pole identifier tags, symbol modifier, and text	0	0.25	G/3	G/2
35	V-POLE-GUYS	V-POLEGYM-	Guying equipment	0	0.25	G/3	G/2
36	V-POLE-GUYS-IDEN	V-POLEGIM-	Guying equipment identifier tags, symbol modifiers, and text	0	0.25	G/3	G/2
Underground Ductbanks (to be used when multiple systems are in one ductbank system)							
37	V-DUCT-MULT	V-DUCTMUM-	Ductbank	EUDUCX	0.25	201	29
38	V-DUCT-MULT-IDEN	V-DUCTMIM-	Identifier tags, symbol modifier and text	0	0.25	201	29
Cathodic Protection System							
40	V-CATH-ANOD	V-CATHANM-	Sacrificial anode system	0	0.25	161	25
41	V-CATH-CURR	V-CATHCUM-	Impress current system	0	0.25	161	25
42	V-CATH-TEST	V-CATHTEM-	Test stations	0	0.25	161	25
43	V-CATH-IDEN	V-CATHIDM-	Identifier tags, symbol modifier, and text	0	0.25	161	25
Special Systems							
45	V-SPCL-TRAF	V-SPCLTRM-	Traffic signal system	0	0.25	151	72
46	V-SPCL-TRAF-IDEN	V-SPCLTIM-	Traffic signal identifier tags, symbol modifier, and text	0	0.25	151	72
47	V-SPCL-SYST	V-SPCLSPM-	Special systems (UMCS, EMCS, CATV, etc.)	0	0.25	151	72
48	V-SPCL-IDEN	V-SPCLIDM-	Special systems (UMCS, EMCS, CATV, etc.) identifier tags, symbol modifier, and text	0	0.25	151	72

Note: V = Varies, NA = Not Applicable

Discipline: Survey/Mapping

Model File Type: Existing Communication Systems Plan

Level #	Level/Layer Naming		Level/Layer Description	Graphics			
	AIA Format	ISO Format		Line Style	Line Width (mm)	AutoCAD Line Color/#	MicroStation Line Color/#
General Information							
1	V-ANNO-DIMS	V-----DIP-	Witness/extension lines, dimension terminators, dimension text	0	V	V	V
2	V-ANNO-KEYN	V-----KEP-	Reference keynotes with associated leaders	0	V	V	V
3	V-ANNO-NPLT	V-----NPP-	Non-plotting graphic information	V	0.18	B/5	B/1
4	V-ANNO-PATT	V-----PAP-	Miscellaneous patterning and hatching	0	0.18	Gr/8	Gr/9
5	V-ANNO-NOTE	V-----NOP-	General notes and general remarks	0	0.35	Y/2	Y/4
6	V-ANNO-SYMB	V-----SYP-	Miscellaneous symbols	V	0.35	M/6	M/5
7	V-ANNO-TEXT	V-----TEP-	Miscellaneous text and callouts with associated leaders	0	V	V	V
NA	V-ANNO-REFR	V-----RFP-	Reference files (AutoCAD users only, see Chapter 4)	NA	NA	NA	NA
Communications Cables (Copper and Fiber Optic)							
11	V-COMM-OVHD	V-COMMOVM-	Overhead communications/telephone lines	COMARX	0.25	81	26
12	V-COMM-OVHD-IDEN	V-COMMOIM-	Identifier tags, symbol modifier and text	0	0.25	81	26
13	V-COMM-UNDR	V-COMMUM-	Underground communications/telephone lines	COMUGX	0.25	81	26
14	V-COMM-UNDR-IDEN	V-COMMUIM-	Identifier tags, symbol modifier and text	0	0.25	81	26
Communications Support Equipment							
23	V-COMM-JBOX	V-COMMJBM-	Communication junction boxes, pull boxes, manholes, handholes, pedestals, splices	0	0.25	21	30
26	V-COMM-EQPM	V-COMMEQM-	Other communications distribution equipment	0	0.25	21	30
Utility Poles (Use only if different from Existing Electrical Utilities Plan poles)							
33	V-POLE-UTIL	V-POLEUTM-	Poles	0	0.25	G/3	G/2
34	V-POLE-IDEN	V-POLEIDM-	Identifier tags, symbol modifier, and text	0	0.25	G/3	G/2
35	V-POLE-GUYS	V-POLEGYM-	Guying equipment	0	0.25	G/3	G/2
36	V-POLE-GUYS-IDEN	V-POLEGIM-	Guying equipment identifier tags, symbol modifiers, and text	0	0.25	G/3	G/2
Underground Ductbanks (to be used when multiple systems are in one ductbank system)							
37	V-DUCT-MULT	V-DUCTMUM-	Ductbank	EUDUCX	0.25	201	29
38	V-DUCT-MULT-IDEN	V-DUCTMIM-	Identifier tags, symbol modifier and text	0	0.25	201	29

Note: V = Varies, NA = Not Applicable

Discipline: Survey/Mapping

Model File Type: Existing Domestic Water Plan

Level #	Level/Layer Naming		Level/Layer Description	Graphics			
	AIA Format	ISO Format		Line Style	Line Width (mm)	AutoCAD Line Color/#	MicroStation Line Color/#
General Information							
1	V-ANNO-DIMS	V-----DIP-	Witness/extension lines, dimension terminators, dimension text	0	V	V	V
2	V-ANNO-KEYN	V-----KEP-	Reference keynotes with associated leaders	0	V	V	V
3	V-ANNO-NPLT	V-----NPP-	Non-plotting graphic information	V	0.18	B/5	B/1
4	V-ANNO-PATT	V-----PAP-	Miscellaneous patterning and hatching	0	0.18	Gr/8	Gr/9
5	V-ANNO-NOTE	V-----NOP-	General notes and general remarks	0	0.35	Y/2	Y/4
6	V-ANNO-SYMB	V-----SYP-	Miscellaneous symbols	V	0.35	M/6	M/5
7	V-ANNO-TEXT	V-----TEP-	Miscellaneous text and callouts with associated leaders	0	V	V	V
NA	V-ANNO-REFR	V-----RFP-	Reference files (AutoCAD users only, see Chapter 4)	NA	NA	NA	NA
Alignments							
8	V-ALGN-DATA	V-ALGNDAM-	Alignment coordinates and curve data	0	0.25	G/3	G/2
9	V-ALGN-LINE	V-ALGNLIM-	Alignments	4	0.35	Y/2	Y/4
10	V-ALGN-STAT	V-ALGNSTM-	Alignment stationing and tick marks	0	0.25	G/3	G/2
Devices							
11	V-DOMW-DEVC	V-DOMWDEM-	Connectors, faucets, reducers, regulators, vents, intake points, tanks, taps, backflow preventers, and valves	0	0.35	M/6	M/5
12	V-DOMW-HYDR	V-DOMWHYM-	Hydrants	0	0.25	R/1	R/3
13	V-DOMW-METR	V-DOMWMEM-	Meters	0	0.25	G/3	G/2
14	V-DOMW-NHYD	V-DOMWNHM-	Non-potable hydrants/flushing hydrant	0	0.25	R/1	R/3
Stations							
16	V-DOMW-PUMP	V-DOMWPUM-	Booster pump stations	0	0.35	M/6	M/5
17	V-DOMW-REDC	V-DOMWREM-	Pressure reducing stations	0	0.35	M/6	M/5
18	V-DOMW-STNS-IDEN	V-DOMWSIM-	Identifier tags, symbol modifier, and tex	0	0.35	Y/2	Y/4
Reservoirs							
19	V-DOMW-RSVR-IDEN	V-DOMWRIM-	Identifier tags, symbol modifier, and text	0	0.25	R/1	R/3
20	V-DOMW-RSVR	V-DOMWRSM-	Reservoirs	0	0.25	R/1	R/3
21	V-DOMW-TANK	V-DOMWTAM-	Water storage tanks	0	0.25	R/1	R/3
22	V-DOMW-WELL	V-DOMWWEM-	Water well houses	0	0.25	R/1	R/3
Pits							
26	V-DOMW-PITS-IDEN	V-DOMWPIM-	Identifier tags, symbol modifier, and text	0	0.25	R/1	R/3
27	V-DOMW-VENT	V-DOMWVEM-	Vent pits	0	0.25	G/3	G/2
28	V-DOMW-VLVE	V-DOMWVLM-	Valve pits/vaults	0	0.25	G/3	G/2
Piping							
32	V-DOMW-ABND	V-DOMWABM-	Abandoned piping	2	0.35	M/6	M/5
37	V-DOMW-FTTG	V-DOMWFTM-	Caps, cleanouts, crosses, and tees	0	0.35	M/6	M/5
40	V-DOMW-IDEN	V-DOMWIDM-	Identifier tags, symbol modifier, and text	0	0.35	Y/2	Y/4
43	V-DOMW-MAIN	V-DOMWMAM-	Main domestic water piping	WATRX	0.35	M/6	M/5
44	V-DOMW-NPOT	V-DOMWNPM-	Non-potable water piping	NONPOT	0.35	M/6	M/5
45	V-DOMW-FIRE	V-DOMWFIM-	Fire lines	FIRE	0.25	R/1	R/3
46	V-DOMW-SERV	V-DOMWSEM-	Domestic water service piping	0	0.35	M/6	M/5
47	V-DOMW-SIGN	V-DOMWSIM-	Surface markers/signs	0	0.25	R/1	R/3

Note: V = Varies, NA = Not Applicable

Discipline: Survey/Mapping

Model File Type: Existing Sanitary Sewer Plan

Level #	Level/Layer Naming		Level/Layer Description	Graphics			
	AIA Format	ISO Format		Line Style	Line Width (mm)	AutoCAD Line Color/#	MicroStation Line Color/#
General Information							
1	V-ANNO-DIMS	V-----DIP-	Witness/extension lines, dimension terminators, dimension text	0	V	V	V
2	V-ANNO-KEYN	V-----KEP-	Reference keynotes with associated leaders	0	V	V	V
3	V-ANNO-NPLT	V-----NPP-	Non-plotting graphic information	V	0.18	B/5	B/1
4	V-ANNO-PATT	V-----PAP-	Miscellaneous patterning and hatching	0	0.18	Gr/8	Gr/9
5	V-ANNO-NOTE	V-----NOP-	General notes and general remarks	0	0.35	Y/2	Y/4
6	V-ANNO-SYMB	V-----SYP-	Miscellaneous symbols	V	0.35	M/6	M/5
7	V-ANNO-TEXT	V-----TEP-	Miscellaneous text and callouts with associated leaders	0	V	V	V
NA	V-ANNO-REFR	V-----RFP-	Reference files (AutoCAD users only, see Chapter 4)	NA	NA	NA	NA
Alignments							
8	V-ALGN-DATA	V-ALGNDAM-	Alignment coordinates and curve data	0	0.25	G/3	G/2
9	V-ALGN-LINE	V-ALGNLIM-	Alignments	4	0.35	Y/2	Y/4
10	V-ALGN-STAT	V-ALGNSTM-	Alignment stationing and tick marks	0	0.25	G/3	G/2
Devices							
11	V-SSWR-DEVC	V-SSWRDEM-	Grease traps, grit chambers, flumes, neutralizers, oil/water separators, ejectors, and valves	0	0.35	M/6	M/5
12	V-SSWR-DEVC-IDEN	V-SSWRDIM-	Identifier tags, symbol modifier, and tex	0	0.35	M/6	M/5
Stations							
15	V-SSWR-PLNT	V-SSWRPLM-	Treatment plants	0	0.35	M/6	M/5
16	V-SSWR-PUMP	V-SSWRPUM-	Booster pump stations	0	0.35	M/6	M/5
18	V-SSWR-STNS-IDEN	V-SSWRSIM-	Identifier tags, symbol modifier, and tex	0	0.35	Y/2	Y/4
Reservoirs							
19	V-SSWR-RSVR-IDEN	V-SSWRRIM-	Identifier tags, symbol modifier, and text	0	0.25	G/3	G/2
20	V-SSWR-LAGN	V-SSWRLAM-	Lagoons	0	0.25	G/3	G/2
21	V-SSWR-TANK	V-SSWRTAM-	Septic tanks	0	0.25	G/3	G/2
Junction Boxes							
22	V-SSWR-JBOX	V-SSWRJBM-	Junction boxes and manholes	0	0.25	R/1	R/3
23	V-SSWR-JBOX-IDEN	V-SSWRJIM-	Identifier tags, symbol modifier, and tex	0	0.25	R/1	R/3
Filtration/Drainage Areas							
26	V-SSWR-FILT	V-SSWRFIM-	Filtration beds	0	0.25	G/3	G/2
27	V-SSWR-FILT-IDEN	V-SSWRFDM-	Identifier tags, symbol modifier, and text	0	0.25	G/3	G/2
28	V-SSWR-NITF	V-SSWRNIM-	Nitrification drain fields	0	0.25	G/3	G/2
29	V-SSWR-LEAC	V-SSWRLEM-	Leach field	0	0.25	G/3	G/2
Piping							
32	V-SSWR-ABND	V-SSWRABM-	Abandoned piping	2	0.35	M/6	M/5
33	V-SSWR-FLOW	V-SSWRFLM-	Flow direction arrows	0	0.35	M/6	M/5
37	V-SSWR-FTTG	V-SSWRFTM-	Caps and cleanouts	0	0.35	M/6	M/5
40	V-SSWR-IDEN	V-SSWRIDM-	Identifier tags, symbol modifier, and text	0	0.35	Y/2	Y/4
43	V-SSWR-MAIN	V-SSWRMAM-	Sanitary sewer piping	SSWAFX	0.35	M/6	M/5
46	V-SSWR-SERV	V-SSWRSEM-	Sanitary sewer service piping	0	0.25	R/1	R/3
47	V-SSWR-SIGN	V-SSWRSIM-	Surface markers/signs	0	0.25	R/1	R/3

Note: V = Varies, NA = Not Applicable

Discipline: Survey/Mapping
Model File Type: Existing Storm Sewer Plan

Level #	Level/Layer Naming		Level/Layer Description	Graphics			
	AIA Format	ISO Format		Line Style	Line Width (mm)	AutoCAD Line Color#	MicroStation Line Color#
General Information							
1	V-ANNO-DIMS	V-----DIP-	Witness/extension lines, dimension terminators, dimension text	0	V	V	V
2	V-ANNO-KEYN	V-----KEP-	Reference keynotes with associated leaders	0	V	V	V
3	V-ANNO-NPLT	V-----NPP-	Non-plotting graphic information	V	0.18	B/5	B/1
4	V-ANNO-PATT	V-----PAP-	Miscellaneous patterning and hatching	0	0.18	Gr/8	Gr/9
5	V-ANNO-NOTE	V-----NOP-	General notes and general remarks	0	0.35	Y/2	Y/4
6	V-ANNO-SYMB	V-----SYP-	Miscellaneous symbols	V	0.35	M/6	M/5
7	V-ANNO-TEXT	V-----TEP-	Miscellaneous text and callouts with associated leaders	0	V	V	V
NA	V-ANNO-REFR	V-----RFP-	Reference files (AutoCAD users only, see Chapter 4)	NA	NA	NA	NA
Alignments							
8	V-ALGN-DATA	V-ALGNDAM-	Alignment coordinates and curve data	0	0.25	G/3	G/2
9	V-ALGN-LINE	V-ALGNLIM-	Alignments	4	0.35	Y/2	Y/4
10	V-ALGN-STAT	V-ALGNSTM-	Alignment stationing and tick marks	0	0.25	G/3	G/2
Devices							
11	V-STRM-DEVC	V-STRMDEM-	Downspouts, flumes, oil/water separators, and flap gates	0	0.35	M/6	M/5
Stations							
16	V-STRM-PUMP	V-STRMPUM-	Pump stations	0	0.35	M/6	M/5
17	V-STRM-FMON	V-STRMFMM-	Flow monitoring station	0	0.35	M/6	M/5
18	V-STRM-STNS-IDEN	V-STRMSIM-	Identifier tags, symbol modifier, and text	0	0.35	Y/2	Y/4
Reservoirs/Watersheds							
19	V-STRM-RSVR-IDEN	V-STRMRIM-	Identifier tags, symbol modifier, and text	0	0.25	G/3	G/2
20	V-STRM-LAGN	V-STRMLAM-	Lagoons, ponds, watersheds, and basins	0	0.25	G/3	G/2
21	V-STRM-AFFF	V-STRMAFM-	AFFF lagoon/detention pond	0	0.25	G/3	G/2
Drainage Structures							
22	V-STRM-MHOL	V-STRMMHM-	Manholes	0	0.25	R/1	R/3
26	V-STRM-DRAN-IDEN	V-STRMDRM-	Identifier tags, symbol modifier, and text	0	0.25	G/3	G/2
27	V-STRM-EROS	V-STRMERM-	Erosion control (riprap)	0	0.18	B/5	B/1
28	V-STRM-CHUT	V-STRMCHM-	Chutes and concrete erosion control structures	0	0.25	R/1	R/3
29	V-STRM-HDWL	V-STRMHDM-	Headwalls and endwalls	0	0.70	W/7	W/0
30	V-STRM-INLT	V-STRMINM-	Inlets (curb, surface, and catch basins)	0	0.25	G/3	G/2
Piping							
32	V-STRM-ABND	V-STRMABM-	Abandoned piping	2	0.35	M/6	M/5
33	V-STRM-FLOW	V-STRMFLM-	Flow direction arrows	0	0.35	M/6	M/5
37	V-STRM-FTTG	V-STRMFTM-	Caps and cleanouts	0	0.35	M/6	M/5
40	V-STRM-IDEN	V-STRMIDM-	Identifier tags, symbol modifier, and text	0	0.35	Y/2	Y/4
42	V-STRM-CULV	V-STRMCLM-	Culverts	0	0.25	G/3	G/2
43	V-STRM-MAIN	V-STRMMAM-	Storm sewer piping	STRAFX	0.35	M/6	M/5
44	V-STRM-SUBS	V-STRMSUM-	Subsurface drain piping	0	0.25	G/3	G/2
45	V-STRM-ROOF	V-STRMROM-	Roof drain line	0	0.25	G/3	G/2
46	V-STRM-SERV	V-STRMSEM-	Storm sewer service piping	0	0.25	R/1	R/3
47	V-STRM-SIGN	V-STRMSIM-	Surface markers/signs	0	0.25	R/1	R/3

Note: V = Varies, NA = Not Applicable

Discipline: Survey/Mapping

Model File Type: Existing Industrial Waste Water Plan

Level #	Level/Layer Naming		Level/Layer Description	Graphics			
	AIA Format	ISO Format		Line Style	Line Width (mm)	AutoCAD Line Color/#	MicroStation Line Color/#
General Information							
1	V-ANNO-DIMS	V-----DIP-	Witness/extension lines, dimension terminators, dimension text	0	V	V	V
2	V-ANNO-KEYN	V-----KEP-	Reference keynotes with associated leaders	0	V	V	V
3	V-ANNO-NPLT	V-----NPP-	Non-plotting graphic information	V	0.18	B/5	B/1
4	V-ANNO-PATT	V-----PAP-	Miscellaneous patterning and hatching	0	0.18	Gr/8	Gr/9
5	V-ANNO-NOTE	V-----NOP-	General notes and general remarks	0	0.35	Y/2	Y/4
6	V-ANNO-SYMB	V-----SYP-	Miscellaneous symbols	V	0.35	M/6	M/5
7	V-ANNO-TEXT	V-----TEP-	Miscellaneous text and callouts with associated leaders	0	V	V	V
NA	V-ANNO-REFR	V-----RFP-	Reference files (AutoCAD users only, see Chapter 4)	NA	NA	NA	NA
Alignments							
8	V-ALGN-DATA	V-ALGNDAM-	Alignment coordinates and curve data	0	0.25	G/3	G/2
9	V-ALGN-LINE	V-ALGNLIM-	Alignments	4	0.35	Y/2	Y/4
10	V-ALGN-STAT	V-ALGNSTM-	Alignment stationing and tick marks	0	0.25	G/3	G/2
Devices							
11	V-INDW-DEVC	V-INDWDEM-	Grit chambers, meters, flumes, neutralizers, oil/water separators, ejectors, tanks, and valves	0	0.35	M/6	M/5
Stations							
15	V-INDW-PLNT	V-INDWPLM-	Treatment plants	0	0.35	M/6	M/5
16	V-INDW-LIFT	V-INDWLIM-	Lift stations	0	0.35	M/6	M/5
18	V-INDW-STNS-IDEN	V-INDWSIM-	Identifier tags, symbol modifier, and text	0	0.35	Y/2	Y/4
Reservoirs							
19	V-INDW-RSVR-IDEN	V-INDWRIM-	Identifier tags, symbol modifier, and text	0	0.35	M/6	M/5
20	V-INDW-LAGN	V-INDWLAM-	Lagoons	0	0.35	M/6	M/5
Junction Boxes							
22	V-INDW-JBOX	V-INDWJBM-	Junction boxes and manholes	0	0.25	R/1	R/3
Piping							
32	V-INDW-ABND	V-INDWABM-	Abandoned piping	2	0.35	M/6	M/5
33	V-INDW-FLOW	V-INDWFLM-	Flow direction arrows	0	0.35	M/6	M/5
37	V-INDW-FTTG	V-INDWFTM-	Caps and cleanouts	0	0.35	M/6	M/5
40	V-INDW-IDEN	V-INDWIDM-	Identifier tags, symbol modifier, and text	0	0.35	Y/2	Y/4
43	V-INDW-MAIN	V-INDWMAM-	Main industrial waste water piping	IWASTE	0.35	M/6	M/5
46	V-INDW-SERV	V-INDWSEM-	Industrial waste water service piping	0	0.25	R/1	R/3
47	V-INDW-SIGN	V-INDWSIM-	Surface markers/signs	0	0.25	R/1	R/3

Note: V = Varies, NA = Not Applicable

Discipline: Survey/Mapping

Model File Type: Existing Natural Gas Utilities Plan

Level #	Level/Layer Naming		Level/Layer Description	Graphics			
	AIA Format	ISO Format		Line Style	Line Width (mm)	AutoCAD Line Color#	MicroStation Line Color#
General Information							
1	V-ANNO-DIMS	V-----DIP-	Witness/extension lines, dimension terminators, dimension text	0	V	V	V
2	V-ANNO-KEYN	V-----KEP-	Reference keynotes with associated leaders	0	V	V	V
3	V-ANNO-NPLT	V-----NPP-	Non-plotting graphic information	V	0.18	B/5	B/1
4	V-ANNO-PATT	V-----PAP-	Miscellaneous patterning and hatching	0	0.18	Gr/8	Gr/9
5	V-ANNO-NOTE	V-----NOP-	General notes and general remarks	0	0.35	Y/2	Y/4
6	V-ANNO-SYMB	V-----SYP-	Miscellaneous symbols	V	0.35	M/6	M/5
7	V-ANNO-TEXT	V-----TEP-	Miscellaneous text and callouts with associated leaders	0	V	V	V
NA	V-ANNO-REFR	V-----RFP-	Reference files (AutoCAD users only, see Chapter 4)	NA	NA	NA	NA
Alignments							
8	V-ALGN-DATA	V-ALGNDAM-	Alignment coordinates and curve data	0	0.25	G/3	G/2
9	V-ALGN-LINE	V-ALGNLIM-	Alignments	4	0.35	Y/2	Y/4
10	V-ALGN-STAT	V-ALGNSTM-	Alignment stationing and tick marks	0	0.25	G/3	G/2
Devices							
11	V-NGAS-DEVC	V-NGASDEM-	Hydrant fill points, lights, vents, markers, rectifiers, reducers, regulators, sources, tanks, drip pots, taps, and valves	0	0.35	M/6	M/5
12	V-NGAS-DEVC-IDEN	V-NGASDIM-	Identifier tags, symbol modifier, and text	0	0.35	M/6	M/5
13	V-NGAS-METR	V-NGASMEM-	Meters	0	0.25	G/3	G/2
Stations							
16	V-NGAS-PUMP	V-NGASPUM-	Compressor stations	0	0.35	M/6	M/5
17	V-NGAS-REDC	V-NGASREM-	Reducing stations	0	0.35	M/6	M/5
18	V-NGAS-STNS-IDEN	V-NGASSIM-	Identifier tags, symbol modifier, and text	0	0.35	Y/2	Y/4
Pits							
26	V-NGAS-PITS-IDEN	V-NGASPIM-	Identifier tags, symbol modifier, and text	0	0.25	R/1	R/3
27	V-NGAS-VENT	V-NGASVEM-	Vent pits	0	0.25	G/3	G/2
28	V-NGAS-VLVE	V-NGASVLM-	Valve pits/boxes	0	0.25	G/3	G/2
Piping							
32	V-NGAS-ABND	V-NGASABM-	Abandoned piping	2	0.35	M/6	M/5
33	V-NGAS-FLOW	V-NGASFLM-	Flow direction arrows	0	0.25	M/6	M/5
37	V-NGAS-FTTG	V-NGASFTM-	Caps, crosses, and tees	0	0.35	M/6	M/5
40	V-NGAS-IDEN	V-NGASIDM-	Identifier tags, symbol modifier, and text	0	0.35	Y/2	Y/4
43	V-NGAS-MAIN	V-NGASMAM-	Main natural gas piping	NTGASX	0.35	M/6	M/5
46	V-NGAS-SERV	V-NGASSEM-	Service piping	0	0.25	R/1	R/3
47	V-NGAS-SIGN	V-NGASSIM-	Surface markers/signs	0	0.25	R/1	R/3

Note: V = Varies, NA = Not Applicable

Discipline: Survey/Mapping

Model File Type: Existing Liquid Fuel Utilities Plan

Level #	Level/Layer Naming		Level/Layer Description	Graphics			
	AIA Format	ISO Format		Line Style	Line Width (mm)	AutoCAD Line Color/#	MicroStation Line Color/#
General Information							
1	V-ANNO-DIMS	V-----DIP-	Witness/extension lines, dimension terminators, dimension text	0	V	V	V
2	V-ANNO-KEYN	V-----KEP-	Reference keynotes with associated leaders	0	V	V	V
3	V-ANNO-NPLT	V-----NPP-	Non-plotting graphic information	V	0.18	B/5	B/1
4	V-ANNO-PATT	V-----PAP-	Miscellaneous patterning and hatching	0	0.18	Gr/8	Gr/9
5	V-ANNO-NOTE	V-----NOP-	General notes and general remarks	0	0.35	Y/2	Y/4
6	V-ANNO-SYMB	V-----SYP-	Miscellaneous symbols	V	0.35	M/6	M/5
7	V-ANNO-TEXT	V-----TEP-	Miscellaneous text and callouts with associated leaders	0	V	V	V
NA	V-ANNO-REFR	V-----RFP-	Reference files (AutoCAD users only, see Chapter 4)	NA	NA	NA	NA
Alignments							
8	V-ALGN-DATA	V-ALGNDAM-	Alignment coordinates and curve data	0	0.25	G/3	G/2
9	V-ALGN-LINE	V-ALGNLIM-	Alignments	4	0.35	Y/2	Y/4
10	V-ALGN-STAT	V-ALGNSTM-	Alignment stationing and tick marks	0	0.25	G/3	G/2
Devices							
11	V-FUEL-DEVC	V-FUELDEM-	Air eliminators, filter strainers, hydrant fill points, line vents, markers, oil/water separators, reducers, regulators, and valves	0	0.35	M/6	M/5
13	V-FUEL-METR	V-FUELMEM-	Meters	0	0.25	G/3	G/2
Stations							
16	V-FUEL-PUMP	V-FUELPU-	Booster pump stations	0	0.35	M/6	M/5
18	V-FUEL-STNS-IDEN	V-FUELSIM-	Identifier tags, symbol modifier, and text	0	0.35	Y/2	Y/4
Reservoirs							
21	V-FUEL-TANK	V-FUELTAM-	Fuel tanks	0	0.25	G/3	G/2
Junction Boxes							
22	V-FUEL-JBOX	V-FUELJBM-	Junction boxes, manholes, handholes, test boxes	0	0.25	R/1	R/3
Pits							
25	V-FUEL-HYDR	V-FUELHYM-	Hydrant control pits	0	0.25	G/3	G/2
26	V-FUEL-PITS-IDEN	V-FUELPI-	Identifier tags, symbol modifier, and text	0	0.25	R/1	R/3
27	V-FUEL-VENT	V-FUELVE-	Vent pits	0	0.25	G/3	G/2
28	V-FUEL-VLVE	V-FUELVL-	Valve pits	0	0.25	G/3	G/2
29	V-FUEL-TRCH	V-FUELTRM-	Fuel line trench	0	0.25	G/3	G/2
Piping							
32	V-FUEL-ABND	V-FUELABM-	Abandoned piping	2	0.35	M/6	M/5
33	V-FUEL-FLOW	V-FUELFLM-	Flow direction arrows	0	0.35	M/6	M/5
36	V-FUEL-DEFL	V-FUELDEM-	Defueling piping	0	0.35	M/6	M/5
37	V-FUEL-FTTG	V-FUELFTM-	Caps, crosses, and tees	0	0.35	M/6	M/5
40	V-FUEL-IDEN	V-FUELIDM-	Identifier tags, symbol modifier, and text	0	0.35	Y/2	Y/4
43	V-FUEL-MAIN	V-FUELMAM-	Main fuel piping	LIQPET	0.35	M/6	M/5
46	V-FUEL-SERV	V-FUELSEM-	Service piping	0	0.35	M/6	M/5

Note: V = Varies, NA = Not Applicable

Discipline: Survey/Mapping
Model File Type: Existing HTCW Utilities Plan

Level #	Level/Layer Naming		Level/Layer Description	Graphics			
	AIA Format	ISO Format		Line Style	Line Width (mm)	AutoCAD Line Color#	MicroStation Line Color#
General Information							
1	V-ANNO-DIMS	V-----DIP-	Witness/extension lines, dimension terminators, dimension text	0	V	V	V
2	V-ANNO-KEYN	V-----KEP-	Reference keynotes with associated leaders	0	V	V	V
3	V-ANNO-NPLT	V-----NPP-	Non-plotting graphic information	V	0.18	B/5	B/1
4	V-ANNO-PATT	V-----PAP-	Miscellaneous patterning and hatching	0	0.18	Gr/8	Gr/9
5	V-ANNO-NOTE	V-----NOP-	General notes and general remarks	0	0.35	Y/2	Y/4
6	V-ANNO-SYMB	V-----SYP-	Miscellaneous symbols	V	0.35	M/6	M/5
7	V-ANNO-TEXT	V-----TEP-	Miscellaneous text and callouts with associated leaders	0	V	V	V
NA	V-ANNO-REFR	V-----RFP-	Reference files (AutoCAD users only, see Chapter 4)	NA	NA	NA	NA
Alignments							
8	V-ALGN-DATA	V-ALGNDAM-	Alignment coordinates and curve data	0	0.25	G/3	G/2
9	V-ALGN-LINE	V-ALGNLIM-	Alignments	4	0.35	Y/2	Y/4
10	V-ALGN-STAT	V-ALGNSTM-	Alignment stationing and tick marks	0	0.25	G/3	G/2
Devices							
11	V-HTCW-DEVC	V-HTCWDEM-	Rigid anchors, anchor guides, rectifiers, reducers, markers, meters, pumps, regulators, tanks, and valves	0	0.35	M/6	M/5
Stations							
16	V-HTCW-PUMP	V-HTCWpum-	Pump stations	0	0.35	M/6	M/5
18	V-HTCW-STNS-IDEN	V-HTCWSIM-	Identifier tags, symbol modifier, and tex	0	0.35	Y/2	Y/4
Plants							
19	V-HTCW-CHLP	V-HTCWCPM-	Chilled water plant	0	0.35	M/6	M/5
20	V-HTCW-HTPP	V-HTCWHPM-	High temperature water plant	0	0.35	M/6	M/5
21	V-HTCW-PLNT-IDEN	V-HTCWpim-	Identifier tags, symbol modifier, and tex	0	0.35	Y/2	Y/4
Junction Boxes							
22	V-HTCW-JBOX	V-HTCWJBM-	Junction boxes, manholes, handholes, test boxes	0	0.25	R/1	R/3
Pits							
25	V-HTCW-PITS	V-HTCWPTM-	Valve pits/vaults, steam pits	0	0.25	G/3	G/2
Piping							
32	V-HTCW-ABND	V-HTCWABM-	Abandoned piping	2	0.35	M/6	M/5
33	V-HTCW-FLOW	V-HTCWFLM-	Flow direction arrows	0	0.25	G/3	G/2
34	V-HTCW-CHLL	V-HTCWCHM-	Main chilled water piping	0	0.35	M/6	M/5
35	V-HTCW-CHLS	V-HTCWCSM-	Chilled water service piping	0	0.25	G/3	G/2
37	V-HTCW-FTTG	V-HTCWFTM-	Caps and flanges	0	0.35	M/6	M/5
38	V-HTCW-HTPL	V-HTCWHM-	Main high temperature piping	0	0.25	R/1	R/3
39	V-HTCW-HTPS	V-HTCWHSM-	High temperature service piping	0	0.25	G/3	G/2
40	V-HTCW-IDEN	V-HTCWIDM-	Identifier tags, symbol modifier, and text	0	0.35	Y/2	Y/4
41	V-HTCW-LTPL	V-HTCWLTM-	Main low temperature piping	0	0.35	Y/2	Y/4
42	V-HTCW-LTPS	V-HTCWLSM-	Low temperature service piping	0	0.25	G/3	G/2
45	V-HTCW-RTRN	V-HTCWRM-	Return for all HTCW lines	0	0.18	B/5	B/1
48	V-HTCW-STML	V-HTCWSTM-	Main steam piping	0	0.25	R/1	R/3
49	V-HTCW-STMS	V-HTCWSSM-	Steam service piping	0	0.25	G/3	G/2
Geothermal Heat Pump System							
50	V-GTHP-EQPM	V-GTHPEQM-	Equipment	0	0.35	M/6	M/5
51	V-GTHP-PIPE	V-GTHPPIM-	Piping (includes fittings, valves)	0	0.35	M/6	M/5

Note: V = Varies, NA = Not Applicable

Discipline: Survey/Mapping
Model File Type: Existing Airfield Lighting Plan

Level #	Level/Layer Naming		Level/Layer Description	Graphics			
	AIA Format	ISO Format		Line Style	Line Width (mm)	AutoCAD Line Color/#	MicroStation Line Color/#
General Information							
1	V-ANNO-DIMS	V-----DIP-	Witness/extension lines, dimension terminators, dimension text	0	V	V	V
2	V-ANNO-KEYN	V-----KEP-	Reference keynotes with associated leaders	0	V	V	V
3	V-ANNO-NPLT	V-----NPP-	Non-plotting graphic information	V	0.18	B/5	B/1
4	V-ANNO-PATT	V-----PAP-	Miscellaneous patterning and hatching	0	0.18	Gr/8	Gr/9
5	V-ANNO-NOTE	V-----NOP-	General notes and general remarks	0	0.35	Y/2	Y/4
6	V-ANNO-SYMB	V-----SYP-	Miscellaneous symbols	V	0.35	M/6	M/5
7	V-ANNO-TEXT	V-----TEP-	Miscellaneous text and callouts with associated leaders	0	V	V	V
NA	V-ANNO-REFR	V-----RFP-	Reference files (AutoCAD users only, see Chapter 4)	NA	NA	NA	NA
Airfield Lighting Circuits							
11	V-CIRC-SERS	V-CIRCSEM-	Series circuits	0	0.35	82	18
12	V-CIRC-MULT	V-CIRCMUM-	Multiple circuits	0	0.35	22	22
13	V-CIRC-CTRL	V-CIRCCTM-	Control and monitoring circuits	0	0.35	12	27
15	V-CIRC-IDEN	V-CIRCIDM-	Identifier tags, symbol modifier, and tex	0	0.35	Y/2	Y/4
Devices							
20	V-AIRF-DEVC	V-AIRFDEM-	Capacitors, voltage regulators, motors, buses, generators, meters, grounds, and markers	0	0.35	M/6	M/5
Junction Boxes							
23	V-AIRF-JBOX	V-AIRFJBM-	Junction boxes, pull boxes, manholes, handholes, pedestals, splice	0	0.25	R/1	R/3
Lights							
25	V-LITE-OBST	V-LITEOBM-	Obstruction lights	0	0.35	Y/2	Y/4
26	V-LITE-DIST	V-LITEDIM-	Distance and arresting gear markers	0	0.35	M/6	M/5
28	V-LITE-APPR	V-LITEAPM-	Approach lights	0	0.35	M/6	M/5
29	V-LITE-THRS	V-LITETHM-	Threshold lights	0	0.35	M/6	M/5
30	V-LITE-RUNW	V-LITERUM-	Runway lights	0	0.35	M/6	M/5
31	V-LITE-TAXI	V-LITETAM-	Taxiway lights	0	0.35	M/6	M/5
32	V-LITE-LANE	V-LITELAM-	Hoverlane, taxilane, and helipad lights	0	0.35	M/6	M/5
33	V-LITE-SIGN	V-LITESIM-	Taxiway guidance signs	0	0.35	M/6	M/5
Ductbank							
37	V-AIRF-DUCT	V-AIRFDUM-	Ductbanks	0	0.25	G/3	G/2
Beacons							
42	V-BCNS-IDEN	V-BCNSIDM-	Identifier tags, symbol modifier, and text	0	0.35	M/6	M/5
43	V-BCNS-STRB	V-BCNSSTM-	Strobe beacons	0	0.35	M/6	M/5
44	V-BCNS-MISC	V-BCNSMIM-	Miscellaneous nav aids - windcones and beacons	0	0.35	M/6	M/5

Note: V = Varies, NA = Not Applicable

Discipline: Survey/Mapping
Model File Type: Existing Profiles

Level #	Level/Layer Naming		Level/Layer Description	Graphics			
	AIA Format	ISO Format		Line Style	Line Width (mm)	AutoCAD Line Color/#	MicroStation Line Color/#
General Information							
1	V-ANNO-DIMS	V-----DIP-	Witness/extension lines, dimension terminators, dimension text	0	V	V	V
2	V-ANNO-KEYN	V-----KEP-	Reference keynotes with associated leaders	0	V	V	V
3	V-ANNO-NPLT	V-----NPP-	Non-plotting graphic information	V	0.18	B/5	B/1
4	V-ANNO-PATT	V-----PAP-	Miscellaneous patterning and hatching	0	0.18	Gr/8	Gr/9
5	V-ANNO-NOTE	V-----NOP-	General notes and general remarks	0	0.35	Y/2	Y/4
6	V-ANNO-SYMB	V-----SYP-	Miscellaneous symbols	V	0.35	M/6	M/5
7	V-ANNO-TEXT	V-----TEP-	Miscellaneous text and callouts with associated leaders	0	V	V	V
NA	V-ANNO-REFR	V-----RFP-	Reference files (AutoCAD users only, see Chapter 4)	NA	NA	NA	NA
Crossing Elements - Use symbology from previous model files							
Grade Linework							
41	V-GRAD-FNSH	V-GRADFNM-	Finished grade	0	0.50	C/4	C/7
44	V-GRAD-EXST	V-GRADEXM-	Existing grade, ground line	3	0.35	M/6	M/5
Grid Lines							
48	V-GRID-MAJR	V-GRIDMAM-	Major grid lines	0	0.25	R/1	R/3
49	V-GRID-MINR	V-GRIDMIM-	Minor grid lines	1	0.18	Gr/8	Gr/9
50	V-GRID-FRAM	V-GRIDFRM-	Frame	0	0.50	C/4	C/7
51	V-GRID-TEXT	V-GRIDTEM-	Border text, annotation	0	0.35	Y/2	Y/4

Note: V = Varies, NA = Not Applicable

Discipline: Survey/Mapping
Model File Type: Existing X-Sections

Level #	Level/Layer Naming		Level/Layer Description	Graphics			
	AIA Format	ISO Format		Line Style	Line Width (mm)	AutoCAD Line Color#	MicroStation Line Color#
General Information							
1	V-ANNO-DIMS	V-----DIP-	Witness/extension lines, dimension terminators, dimension text	0	V	V	V
2	V-ANNO-KEYN	V-----KEP-	Reference keynotes with associated leaders	0	V	V	V
3	V-ANNO-NPLT	V-----NPP-	Non-plotting graphic information	V	0.18	B/5	B/1
4	V-ANNO-PATT	V-----PAP-	Miscellaneous patterning and hatching	0	0.18	Gr/8	Gr/9
5	V-ANNO-NOTE	V-----NOP-	General notes and general remarks	0	0.35	Y/2	Y/4
6	V-ANNO-SYMB	V-----SYP-	Miscellaneous symbols	V	0.35	M/6	M/5
7	V-ANNO-TEXT	V-----TEP-	Miscellaneous text and callouts with associated leaders	0	V	V	V
NA	V-ANNO-REFR	V-----RFP-	Reference files (AutoCAD users only, see Chapter 4)	NA	NA	NA	NA
Crossing Elements - Use symbology from previous model files							
Sections							
35	V-SECT-IDEN	V-SECTIDM-	Component identification numbers	0	0.35	Y/2	Y/4
36	V-SECT-MBND	V-SECTMBM-	Material beyond section cut	0	0.18	B/5	B/1
37	V-SECT-MCUT	V-SECTMCM-	Material cut by section	0	0.50	C/4	C/7
38	V-SECT-PATT	V-SECTPAM-	Textures and hatch patterns	0	0.18	Gr/8	Gr/9
Grade Linework							
41	V-GRAD-FNSH	V-GRADFNM-	Finished grade	0	0.50	C/4	C/7
44	V-GRAD-EXST	V-GRADEXM-	Existing grade, ground line	3	0.35	M/6	M/5
Grid Lines							
48	V-GRID-MAJR	V-GRIDMAM-	Major grid lines	0	0.25	R/1	R/3
49	V-GRID-MINR	V-GRIDMIM-	Minor grid lines	1	0.18	Gr/8	Gr/9
50	V-GRID-FRAM	V-GRIDFRM-	Frame	0	0.50	C/4	C/7
51	V-GRID-TEXT	V-GRIDTEM-	Border text, annotation	0	0.35	Y/2	Y/4

Note: V = Varies, NA = Not Applicable

Discipline: Geotechnical

Model File Type: Boring Location Plan

Level #	Level/Layer Naming		Level/Layer Description	Graphics			
	AIA Format	ISO Format		Line Style	Line Width (mm)	AutoCAD Line Color#	MicroStation Line Color#
General Information							
1	B-ANNO-DIMS	B-----DIP-	Witness/extension lines, dimension terminators, dimension text	0	V	V	V
2	B-ANNO-KEYN	B-----KEP-	Reference keynotes with associated leaders	0	V	V	V
3	B-ANNO-NPLT	B-----NPP-	Non-plotting graphic information	V	0.18	B/5	B/1
4	B-ANNO-PATT	B-----PAP-	Miscellaneous patterning and hatching	0	0.18	Gr/8	Gr/9
5	B-ANNO-NOTE	B-----NOP-	General notes and general remarks	0	0.35	Y/2	Y/4
6	B-ANNO-SYMB	B-----SYP-	Miscellaneous symbols	V	0.35	M/6	M/5
7	B-ANNO-TEXT	B-----TEP-	Miscellaneous text and callouts with associated leaders	0	V	V	V
NA	B-ANNO-REFR	B-----RFP-	Reference files (AutoCAD users only, see Chapter 4)	NA	NA	NA	NA
Borings/Perc Holes							
12	B-BORE-HOLE	B-BOREHOM-	Bore/perc hole locations	0	0.35	Y/2	Y/4
13	B-BORE-IDEN	B-BOREIDM-	Bore/perc hole numbers	0	0.35	Y/2	Y/4

Note: V = Varies, NA = Not Applicable

Discipline: Geotechnical
Model File Type: Boring Log

Level #	Level/Layer Naming		Level/Layer Description	Graphics			
	AIA Format	ISO Format		Line Style	Line Width (mm)	AutoCAD Line Color#	MicroStation Line Color#
General Information							
1	B-ANNO-DIMS	B-----DIP-	Witness/extension lines, dimension terminators, dimension text	0	V	V	V
2	B-ANNO-KEYN	B-----KEP-	Reference keynotes with associated leaders	0	V	V	V
3	B-ANNO-NPLT	B-----NPP-	Non-plotting graphic information	V	0.18	B/5	B/1
4	B-ANNO-PATT	B-----PAP-	Miscellaneous patterning and hatching	0	0.18	Gr/8	Gr/9
5	B-ANNO-NOTE	B-----NOP-	General notes and general remarks	0	0.35	Y/2	Y/4
6	B-ANNO-SYMB	B-----SYP-	Miscellaneous symbols	V	0.35	M/6	M/5
7	B-ANNO-TEXT	B-----TEP-	Miscellaneous text and callouts with associated leaders	0	V	V	V
NA	B-ANNO-REFR	B-----RFP-	Reference files (AutoCAD users only, see Chapter 4)	NA	NA	NA	NA
Borings/Perc Holes							
10	B-BORE-ELEV	B-BOREELM-	Boring elevations	0	0.25	G/3	G/2
11	B-BORE-FDTA	B-BOREFDM-	Field data	0	0.25	G/3	G/2
12	B-BORE-HOLE	B-BOREHOM-	Bore/perc hole number	0	0.35	Y/2	Y/4
13	B-BORE-IDEN	B-BOREIDM-	Component identification numbers	0	0.35	Y/2	Y/4
14	B-BORE-LDTA	B-BORELDM-	Laboratory data	0	0.25	R/1	R/3
15	B-BORE-PATT	B-BOREPAM-	Soil/rock patterns	0	0.18	Gr/8	Gr/9

Note: V = Varies, NA = Not Applicable

Discipline: Civil
Model File Type: Site Plan

Level #	Level/Layer Naming		Level/Layer Description	Graphics			
	AIA Format	ISO Format		Line Style	Line Width (mm)	AutoCAD Line Color/#	MicroStation Line Color/#
General Information							
1	C-ANNO-DIMS	C-----DIP-	Witness/extension lines, dimension terminators, dimension text	0	V	V	V
2	C-ANNO-KEYN	C-----KEP-	Reference keynotes with associated leaders	0	V	V	V
3	C-ANNO-NPLT	C-----NPP-	Non-plotting graphic information	V	0.18	B/5	B/1
4	C-ANNO-PATT	C-----PAP-	Miscellaneous patterning and hatching	0	0.18	Gr/8	Gr/9
5	C-ANNO-NOTE	C-----NOP-	General notes and general remarks	0	0.35	Y/2	Y/4
6	C-ANNO-SYMB	C-----SYP-	Miscellaneous symbols	V	0.35	M/6	M/5
7	C-ANNO-TEXT	C-----TEP-	Miscellaneous text and callouts with associated leaders	0	V	V	V
NA	C-ANNO-REFR	C-----RFP-	Reference files (AutoCAD users only, see Chapter 4)	NA	NA	NA	NA
Alignments							
8	C-ALGN-DATA	C-ALGNDAM-	Alignment coordinates and curve data	0	0.25	G/3	G/2
9	C-ALGN-LINE	C-ALGNLIM-	Alignments	4	0.35	Y/2	Y/4
10	C-ALGN-STAT	C-ALGNSTM-	Alignment stationing and tick marks	0	0.25	G/3	G/2
Buildings and Structures							
11	C-BLDG-OTLN	C-BLDGOTM-	Buildings and other structures	0	0.70	W/7	W/0
12	C-BLDG-IDEN	C-BLDGIDM-	Building and other structure annotator	0	0.35	Y/2	Y/4
Site Improvement							
13	C-SITE-FENC	C-SITEFEM-	Fences and handrails	0, FENCE	0.35	M/6	M/5
14	C-SITE-FENC-IDEN	C-SITEFIM-	Fence, handrail, ramp, sign, and trail annotation	0	0.35	M/6	M/5
15	C-SITE-STRC	C-SITESRM-	Structures (bridges, sheds, foundation pads, footings, etc.)	0	0.35	22	22
16	C-SITE-IDEN	C-SITEIDM-	Site improvement annotation	0	0.35	M/6	M/5
17	C-SITE-IMPR	C-SITEIMM-	Site improvements (channel or levee features)	0	0.50	C/4	C/7
18	C-SITE-EROS	C-SITEERM-	Riprap, revetments/stone protection, breakwaters, dikes, jetties, and drains	0	0.25	R/1	R/3
19	C-SITE-EROS-IDEN	C-SITEEIM-	Riprap, revetment/stone protection, breakwater, dike, jetty, and drain annotation	0	0.35	12	27
20	C-SITE-STRS	C-SITESTM-	Stairs and ramps	0	0.35	M/6	M/5
21	C-SITE-WALK	C-SITEWAM-	Walks, trails and bicycle paths	V	0.35	Y/2	Y/4
Property							
25	C-PROP-ESMT	C-PROPEM-	Easements	3	0.70	84	34
26	C-PROP-CONS	C-PROPCOM-	Construction limits/controls, staging area	11	0.70	W/7	W/0
27	C-PROP-RWAY	C-PROPRWM-	Right of ways	RTOFWY	0.70	W/7	W/0
28	C-PROP-IDEN	C-PROPIDM-	Property annotation	0	0.35	M/6	M/5
Storm Drainage (for more detailed storm drainage, use the Civil - Storm Drainage model file)							
30	C-STRM-STRC	C-STRMSTM-	Storm drainage, headwalls, inlets, manholes, culverts, and drainage structures	0, STRAF	0.50	C/4	C/7
31	C-STRM-IDEN	C-STRMIDM-	Storm drainage, headwall, inlet, manhole, culvert, and drainage structure annotation	0	0.35	Y/2	Y/4
Pavements/Transportation (for more detailed transportation, use the Civil - Transportation Site Plan model file)							
34	C-PVMT-ROAD	C-PVMTROM-	Roads, parking lots, railroads, airfield pavements	0, RAILRD	0.35	Y/2	Y/4
35	C-PVMT-IDEN	C-PVMTIDM-	Road, parking lot, railroad, airfield pavement annotation	0	0.35	Y/2	Y/4
36	C-PVMT-PATT	C-PVMTMAM-	Joint patterns, text and dimensions	0	0.35	Y/2	Y/4
37	C-PVMT-MRKG	C-PVMTMRM-	Pavement markings and signs	0	0.35	Y/2	Y/4
Secondary Alignments							
38	C-ALGN-SECD	C-ALGNSCM-	Secondary alignments	0	0.25	G/3	G/2
39	C-ALGN-SECD-IDEN	C-ALGNSIM-	Alignment stationing and tick marks	0	0.35	82	18
Topography							
40	C-TOPO-COOR	C-TOPOCOM-	Coordinate grid ticks and text	0	0.35	122	23
41	C-TOPO-MAJR-IDEN	C-TOPOMAM-	Major contours - annotation	0	0.35	Y/2	Y/4
42	C-TOPO-MAJR	C-TOPOMJM-	Major contours	0	0.35	Y/2	Y/4
43	C-TOPO-MINR-IDEN	C-TOPOMIM-	Minor contours - annotation	0	0.25	G/3	G/2
44	C-TOPO-MINR	C-TOPOMNM-	Minor contours	0	0.25	G/3	G/2
46	C-TOPO-SLOP-IDEN	C-TOPOSIM-	Cut/fill slope, top/toe slope annotation	0	0.35	Y/2	Y/4
47	C-TOPO-SLOP-FILL	C-TOPOSFM-	Cut/fill slopes	0	0.35	Y/2	Y/4
48	C-TOPO-SPOT	C-TOPOSPM-	Spot elevations	0	0.35	Y/2	Y/4
49	C-TOPO-SLOP-TOPT	C-TOPOSTM-	Top/toe slopes	0	0.35	M/6	M/5

Discipline: Civil
Model File Type: Site Plan

Demolition (used only in creating Existing/Demolition model files)						
56	C-STAT-DEMO-PHS1	C-----M-D----1	Demolition - phase 1	0	0.50	203 45
57	C-STAT-DEMO-PHS2	C-----M-D----2	Demolition - phase 2	0	0.50	83 42
58	C-STAT-DEMO-PHS3	C-----M-D----3	Demolition - phase 3	0	0.50	163 41

Note: V = Varies, NA = Not Applicable

Discipline: Civil

Model File Type: Grading Plan

Level #	Level/Layer Naming		Level/Layer Description	Graphics			
	AIA Format	ISO Format		Line Style	Line Width (mm)	AutoCAD Line Color#	MicroStation Line Color#
General Information							
1	C-ANNO-DIMS	C-----DIP-	Witness/extension lines, dimension terminators, dimension text	0	V	V	V
2	C-ANNO-KEYN	C-----KEP-	Reference keynotes with associated leaders	0	V	V	V
3	C-ANNO-NPLT	C-----NPP-	Non-plotting graphic information	V	0.18	B/5	B/1
4	C-ANNO-PATT	C-----PAP-	Miscellaneous patterning and hatching	0	0.18	Gr/8	Gr/9
5	C-ANNO-NOTE	C-----NOP-	General notes and general remarks	0	0.35	Y/2	Y/4
6	C-ANNO-SYMB	C-----SYP-	Miscellaneous symbols	V	0.35	M/6	M/5
7	C-ANNO-TEXT	C-----TEP-	Miscellaneous text and callouts with associated leaders	0	V	V	V
NA	C-ANNO-REFR	C-----RFP-	Reference files (AutoCAD users only, see Chapter 4)	NA	NA	NA	NA
Alignments							
8	C-ALGN-DATA	C-ALGNDAM-	Alignment coordinates and curve data	0	0.25	G/3	G/2
9	C-ALGN-LINE	C-ALGNLIM-	Alignments	4	0.35	Y/2	Y/4
10	C-ALGN-STAT	C-ALGNSTM-	Alignment stationing and tick marks	0	0.25	G/3	G/2
Borrow Areas							
21	C-BORW-LINE	C-BORWLNM-	Borrow/Spoil area	2	0.35	Y/2	Y/4
22	C-BORW-IDEN	C-BORWIDM-	Borrow/Spoil area annotation	0	0.35	Y/2	Y/4
Topography							
40	C-TOPO-COOR	C-TOPOCOM-	Coordinate grid ticks and text	0	0.35	122	23
41	C-TOPO-MAJR-IDEN	C-TOPOMAM-	Major contours - annotation	0	0.35	Y/2	Y/4
42	C-TOPO-MAJR	C-TOPOMJM-	Major contours	0	0.35	Y/2	Y/4
43	C-TOPO-MINR-IDEN	C-TOPOMIM-	Minor contours - annotation	0	0.25	G/3	G/2
44	C-TOPO-MINR	C-TOPOMNM-	Minor contours	0	0.25	G/3	G/2
46	C-TOPO-SLOP-IDEN	C-TOPOSIM-	Cut/fill slope, top/toe slope annotation	0	0.35	Y/2	Y/4
47	C-TOPO-SLOP-FILL	C-TOPOSFM-	Cut/fill slopes	0	0.35	Y/2	Y/4
48	C-TOPO-SPOT	C-TOPOSPM-	Spot elevations	0	0.35	Y/2	Y/4
49	C-TOPO-SLOP-TOPT	C-TOPOSTM-	Top/toe slopes	0	0.35	M/6	M/5
50	C-TOPO-BKLN	C-TOPOBKM-	Breaklines	4	0.70	W/7	W/0
51	C-TOPO-DTMT	C-TOPODTM-	DTM triangles	0	0.35	22	22
52	C-TOPO-DTMP	C-TOPODPM-	DTM points	0	0.35	M/6	M/5
Demolition (used only in creating Existing/Demolition model files)							
56	C-STAT-DEMO-PHS1	C-----M-D----1	Demolition - phase 1	0	0.50	203	45
57	C-STAT-DEMO-PHS2	C-----M-D----2	Demolition - phase 2	0	0.50	83	42
58	C-STAT-DEMO-PHS3	C-----M-D----3	Demolition - phase 3	0	0.50	163	41

Note: V = Varies, NA = Not Applicable

Discipline: Civil

Model File Type: Dredging Plan

Level #	Level/Layer Naming		Level/Layer Description	Graphics			
	AIA Format	ISO Format		Line Style	Line Width (mm)	AutoCAD Line Color/#	MicroStation Line Color/#
General Information							
1	C-ANNO-DIMS	C-----DIP-	Witness/extension lines, dimension terminators, dimension text	0	V	V	V
2	C-ANNO-KEYN	C-----KEP-	Reference keynotes with associated leaders	0	V	V	V
3	C-ANNO-NPLT	C-----NPP-	Non-plotting graphic information	V	0.18	B/5	B/1
4	C-ANNO-PATT	C-----PAP-	Miscellaneous patterning and hatching	0	0.18	Gr/8	Gr/9
5	C-ANNO-NOTE	C-----NOP-	General notes and general remarks	0	0.35	Y/2	Y/4
6	C-ANNO-SYMB	C-----SYP-	Miscellaneous symbols	V	0.35	M/6	M/5
7	C-ANNO-TEXT	C-----TEP-	Miscellaneous text and callouts with associated leaders	0	V	V	V
NA	C-ANNO-REFR	C-----RFP-	Reference files (AutoCAD users only, see Chapter 4)	NA	NA	NA	NA
Survey Lines							
8	C-SURV-DATA	C-SURVDAM-	Survey data (benchmarks and horizontal control points or monuments)	0	0.35	M/6	M/5
9	C-SURV-LINE	C-SURVLIM-	Survey, baseline, and control lines	2	0.50	C/4	C/7
10	C-SURV-IDEN	C-SURVIDM-	Survey, baseline, and control line annotator	0	0.35	M/6	M/5
Structures							
11	C-STRC-OTLN	C-STRCOTM-	Bridges, piers, breakwaters, docks, floats, etc. - outlines	0	0.50	C/4	C/7
12	C-STRC-IDEN	C-STRCIDM-	Bridges, piers, breakwaters, docks, floats, etc. - annotator	0	0.35	Y/2	Y/4
Channels							
14	C-CHAN-LIMIT	C-CHANLIM-	Channel limits, anchorages, turning basins, disposal areas, etc.	0	0.35	M/6	M/5
15	C-CHAN-IDEN	C-CHANIDM-	Channel limits, anchorages, turning basins, disposal areas, etc. - annotation	0	0.35	M/6	M/5
16	C-CHAN-DACL	C-CHANDAM-	De-authorized channel limits, anchorages, etc.	0	0.25	G/3	G/2
17	C-CHAN-DACL-IDEN	C-CHANDIM-	De-authorized channel limits, anchorages, etc. - annotation	0	0.25	G/3	G/2
18	C-CHAN-CNTR	C-CHANCNM-	Channel centerline and survey report lines	4	0.18	B/5	B/1
19	C-CHAN-CNTR-IDEN	C-CHANCNM-	Channel centerline and survey report lines - annotation	0	0.18	B/5	B/1
20	C-CHAN-AIDS	C-CHANAIM-	Navigation aids and text	0	0.35	Y/2	Y/4
21	C-CHAN-TURN	C-CHANTUM-	Turning points	0	0.35	Y/2	Y/4
Dredging							
25	C-DRED-LIMIT	C-DREDLIM-	Dredge limit lines	0	0.50	C/4	C/7
26	C-DRED-OHWM	C-DREDOHM-	Ordinary high water marks	0	0.35	Y/2	Y/4
Topography							
39	C-TOPO-BORE	C-TOPOBOM-	Boring locations	0	0.35	M/6	M/5
40	C-TOPO-COOR	C-TOPOCOM-	Coordinate grid ticks and text	0	0.35	122	23
41	C-TOPO-MAJR-IDEN	C-TOPOMAM-	Major contours - annotation	0	0.35	Y/2	Y/4
42	C-TOPO-MAJR	C-TOPOMJM-	Major contours	0	0.35	Y/2	Y/4
43	C-TOPO-MINR-IDEN	C-TOPOMIM-	Minor contours - annotation	0	0.25	G/3	G/2
44	C-TOPO-MINR	C-TOPOMNM-	Minor contours	0	0.25	G/3	G/2
45	C-TOPO-SHOR	C-TOPOSHM-	Shorelines, land features, and references	0	0.50	C/4	C/7
49	C-TOPO-SOUN	C-TOPOSOM-	Soundings	0	0.18	150	40
Demolition (used only in creating Existing/Demolition model files)							
56	C-STAT-DEMO-PHS1	C-----M-D----1	Demolition - phase 1	0	0.50	203	45
57	C-STAT-DEMO-PHS2	C-----M-D----2	Demolition - phase 2	0	0.50	83	42
58	C-STAT-DEMO-PHS3	C-----M-D----3	Demolition - phase 3	0	0.50	163	41

Note: V = Varies, NA = Not Applicable

Discipline: Civil

Model File Type: Transportation Site Plan

Level #	Level/Layer Naming		Level/Layer Description	Graphics			
	AIA Format	ISO Format		Line Style	Line Width (mm)	AutoCAD Line Color#	MicroStation Line Color#
General Information							
1	C-ANNO-DIMS	C-----DIP-	Witness/extension lines, dimension terminators, dimension text	0	V	V	V
2	C-ANNO-KEYN	C-----KEP-	Reference keynotes with associated leaders	0	V	V	V
3	C-ANNO-NPLT	C-----NPP-	Non-plotting graphic information	V	0.18	B/5	B/1
4	C-ANNO-PATT	C-----PAP-	Miscellaneous patterning and hatching	0	0.18	Gr/8	Gr/9
5	C-ANNO-NOTE	C-----NOP-	General notes and general remarks	0	0.35	Y/2	Y/4
6	C-ANNO-SYMB	C-----SYP-	Miscellaneous symbols	V	0.35	M/6	M/5
7	C-ANNO-TEXT	C-----TEP-	Miscellaneous text and callouts with associated leaders	0	V	V	V
NA	C-ANNO-REFR	C-----RFP-	Reference files (AutoCAD users only, see Chapter 4)	NA	NA	NA	NA
Alignments							
8	C-ALGN-DATA	C-ALGNDAM-	Alignment coordinates and curve data	0	0.25	G/3	G/2
9	C-ALGN-LINE	C-ALGNLIM-	Alignments	4	0.35	Y/2	Y/4
10	C-ALGN-STAT	C-ALGNSTM-	Alignment stationing and tick marks	0	0.25	G/3	G/2
Major Roads							
11	C-ROAD-CNTR-IDEN	C-ROADCIM-	Centerline annotation	0	0.35	M/6	M/5
12	C-ROAD-CNTR	C-ROADCTM-	Centerlines	7	0.25	R/1	R/3
13	C-ROAD-CURB	C-ROADCUM-	Curbs	0	0.35	M/6	M/5
14	C-ROAD-GRAL	C-ROADGRM-	Guardrails	0	0.35	M/6	M/5
15	C-ROAD-IDEN	C-ROADIDM-	Road, curb, and guardrail annotation	0	0.35	M/6	M/5
16	C-ROAD-OTLN	C-ROADOTM-	Roads	0	0.50	C/4	C/7
Parking Lots and Minor Roads							
21	C-PKNG-CARS	C-PKNGCAM-	Graphic illustration of cars	0	0.35	Y/2	Y/4
22	C-PKNG-CNTR-IDEN	C-PKNGCIM-	Centerline annotation	0	0.35	M/6	M/5
23	C-PKNG-CNTR	C-PKNGCTM-	Centerlines	7	0.25	R/1	R/3
24	C-PKNG-CURB	C-PKNGCUM-	Curbs and gutters	0	0.25	G/3	G/2
25	C-PKNG-DRAN	C-PKNGDRM-	Parking lot drainage slope indications	0	0.25	R/1	R/3
26	C-PKNG-IDEN	C-PKNGIDM-	Parking lot, minor road, and curb annotation	0	0.35	M/6	M/5
27	C-PKNG-FIXT	C-PKNGFIM-	Parking lot fixtures (e.g., wheel stops, parking meters)	0	0.25	91	106
28	C-PKNG-OTLN	C-PKNGOTM-	Parking lots and minor roads	0	0.50	C/4	C/7
Railroads							
32	C-RAIL-EQPM	C-RAILEQM-	Railroad equipment (e.g., gates, signals)	0	0.25	91	106
33	C-RAIL-CNTR-IDEN	C-RAILCIM-	Centerline annotation	0	0.35	M/6	M/5
34	C-RAIL-CNTR	C-RAILCTM-	Centerlines	7	0.25	R/1	R/3
35	C-RAIL-IDEN	C-RAILIDM-	Railroad - annotation	0	0.35	M/6	M/5
36	C-RAIL-TRAK	C-RAILTRM-	Railroads	0	0.35	Y/2	Y/4
Signage and Pavement Markings							
37	C-PVMT-MRKG	C-PVMTMRM-	Pavement markings and traffic signs	0	0.35	Y/2	Y/4
38	C-PVMT-SIGN	C-PVMTSIM-	Other signs	0	0.35	Y/2	Y/4
Pavement Types							
41	C-PVMT-ASPH	C-PVMTASM-	Pavement pattern - asphalt	0	0.18	Gr/8	Gr/9
42	C-PVMT-CONC	C-PVMTCOM-	Pavement pattern - concrete	0	0.18	Gr/8	Gr/9
43	C-PVMT-GRVL	C-PVMTGRM-	Pavement pattern - gravel	0	0.18	Gr/8	Gr/9
Demolition (used only in creating Existing/Demolition model files)							
56	C-STAT-DEMO-PHS1	C-----M-D---1	Demolition - phase 1	0	0.50	203	45
57	C-STAT-DEMO-PHS2	C-----M-D---2	Demolition - phase 2	0	0.50	83	42
58	C-STAT-DEMO-PHS3	C-----M-D---3	Demolition - phase 3	0	0.50	163	41

Note: V = Varies, NA = Not Applicable

Discipline: Civil

Model File Type: Joint Layout Plan

Level #	Level/Layer Naming		Level/Layer Description	Graphics			
	AIA Format	ISO Format		Line Style	Line Width (mm)	AutoCAD Line Color/#	MicroStation Line Color/#
General Information							
1	C-ANNO-DIMS	C-----DIP-	Witness/extension lines, dimension terminators, dimension text	0	V	V	V
2	C-ANNO-KEYN	C-----KEP-	Reference keynotes with associated leaders	0	V	V	V
3	C-ANNO-NPLT	C-----NPP-	Non-plotting graphic information	V	0.18	B/5	B/1
4	C-ANNO-PATT	C-----PAP-	Miscellaneous patterning and hatching	0	0.18	Gr/8	Gr/9
5	C-ANNO-NOTE	C-----NOP-	General notes and general remarks	0	0.35	Y/2	Y/4
6	C-ANNO-SYMB	C-----SYP-	Miscellaneous symbols	V	0.35	M/6	M/5
7	C-ANNO-TEXT	C-----TEP-	Miscellaneous text and callouts with associated leaders	0	V	V	V
NA	C-ANNO-REFR	C-----RFP-	Reference files (AutoCAD users only, see Chapter 4)	NA	NA	NA	NA
Joints							
11	C-JOIN-CNSL	C-JOINSLM-	Construction joints - longitudinal	0	0.35	M/6	M/5
12	C-JOIN-CNST	C-JOINSTM-	Construction joints - transverse	0	0.35	M/6	M/5
13	C-JOIN-CNTL	C-JOINTLM-	Contraction joints - longitudinal	0	0.35	Y/2	Y/4
14	C-JOIN-CNTT	C-JOINTTM-	Contraction joints - transverse	0	0.35	Y/2	Y/4
15	C-JOIN-EXPN	C-JOINEXM-	Expansion joints	0	0.35	12	27
16	C-JOIN-EDGE	C-JOINEDM-	Thickened edges	0	0.50	C/4	C/7
Pavements							
36	C-PVMT-PATT	C-PVMTSAM-	Reinforced pavement pattern	0	0.18	Gr/8	Gr/9
Topography							
48	C-TOPO-SPOT	C-TOPOSPM-	Spot elevations	0	0.35	Y/2	Y/4
Demolition (used only in creating Existing/Demolition model files)							
56	C-STAT-DEMO-PHS1	C-----M-D----1	Demolition - phase 1	0	0.50	203	45
57	C-STAT-DEMO-PHS2	C-----M-D----2	Demolition - phase 2	0	0.50	83	42
58	C-STAT-DEMO-PHS3	C-----M-D----3	Demolition - phase 3	0	0.50	163	41

Note: V = Varies, NA = Not Applicable

Discipline: Civil

Model File Type: Airfield Plan

Level #	Level/Layer Naming		Level/Layer Description	Graphics			
	AIA Format	ISO Format		Line Style	Line Width (mm)	AutoCAD Line Color/#	MicroStation Line Color/#
General Information							
1	C-ANNO-DIMS	C-----DIP-	Witness/extension lines, dimension terminators, dimension text	0	V	V	V
2	C-ANNO-KEYN	C-----KEP-	Reference keynotes with associated leaders	0	V	V	V
3	C-ANNO-NPLT	C-----NPP-	Non-plotting graphic information	V	0.18	B/5	B/1
4	C-ANNO-PATT	C-----PAP-	Miscellaneous patterning and hatching	0	0.18	Gr/8	Gr/9
5	C-ANNO-NOTE	C-----NOP-	General notes and general remarks	0	0.35	Y/2	Y/4
6	C-ANNO-SYMB	C-----SYP-	Miscellaneous symbols	V	0.35	M/6	M/5
7	C-ANNO-TEXT	C-----TEP-	Miscellaneous text and callouts with associated leaders	0	V	V	V
NA	C-ANNO-REFR	C-----RFP-	Reference files (AutoCAD users only, see Chapter 4)	NA	NA	NA	NA
Alignments							
8	C-ALGN-DATA	C-ALGNDAM-	Alignment coordinates and curve data	0	0.25	G/3	G/2
9	C-ALGN-LINE	C-ALGNLIM-	Alignments	4	0.35	Y/2	Y/4
10	C-ALGN-STAT	C-ALGNSTM-	Alignment stationing and tick marks	0	0.25	G/3	G/2
Taxiway							
11	C-TAXI-CNTR-IDEN	C-TAXICIM-	Centerline annotation	0	0.35	Y/2	Y/4
12	C-TAXI-CNTR	C-TAXICTM-	Centerlines	7	0.25	R/1	R/3
13	C-TAXI-IDEN	C-TAXIIDM-	Taxiway - annotation	0	0.35	Y/2	Y/4
15	C-TAXI-OTLN	C-TAXIOTM-	Taxiway - outlines	0	0.50	C/4	C/7
16	C-TAXI-SHLD	C-TAXISHM-	Shoulders with annotation	0	0.35	Y/2	Y/4
Apron							
18	C-APRN-CNTR-IDEN	C-APRNCIM-	Centerline annotation	0	0.35	Y/2	Y/4
19	C-APRN-CNTR	C-APRNCMT-	Centerlines	7	0.25	R/1	R/3
20	C-APRN-IDEN	C-APRNIDM-	Airfield apron - annotation	0	0.35	Y/2	Y/4
22	C-APRN-OTLN	C-APRNOTM-	Airfield apron - outlines	0	0.50	C/4	C/7
23	C-APRN-SHLD	C-APRNSHM-	Shoulders with annotation	0	0.35	Y/2	Y/4
Overrun Areas							
25	C-OVRN-CNTR-IDEN	C-OVRNCIM-	Centerline annotation	0	0.35	Y/2	Y/4
26	C-OVRN-CNTR	C-OVRNCMT-	Centerlines	7	0.25	R/1	R/3
27	C-OVRN-IDEN	C-OVRNIDM-	Airfield overrun area - annotation	0	0.35	Y/2	Y/4
29	C-OVRN-OTLN	C-OVRNOTM-	Airfield overrun area - outlines	0	0.50	C/4	C/7
Airfield Traffic Types							
31	C-TRAF-TYPA	C-TRAFTAM-	Type A traffic area	4	0.50	C/4	C/7
32	C-TRAF-TYPB	C-TRAFTBM-	Type B traffic area	6	0.50	C/4	C/7
33	C-TRAF-TYPC	C-TRAFTCM-	Type C traffic area	10	0.50	C/4	C/7
34	C-TRAF-IDEN	C-TRAFIDM-	Airfield traffic area annotation	0	0.35	Y/2	Y/4
Runway							
35	C-RUNW-CNTR	C-RUNWCTM-	Centerlines	7	0.25	R/1	R/3
36	C-RUNW-IDEN	C-RUNWIDM-	Airfield runway annotation	0	0.35	Y/2	Y/4
37	C-RUNW-EDGE	C-RUNWRUM-	Airfield runway edges	0	0.35	M/6	M/5
Obstructions							
40	C-OBST-AIRS	C-OBSTAIM-	Airspace obstructions	0	0.25	G/3	G/2
Pavement Types							
41	C-PVMT-ASPH	C-PVMTASM-	Pavement pattern - asphalt	0	0.18	Gr/8	Gr/9
42	C-PVMT-CONC	C-PVMTCOM-	Pavement pattern - concrete	0	0.18	Gr/8	Gr/9
43	C-PVMT-GRVL	C-PVMTGRM-	Pavement pattern - gravel	0	0.18	Gr/8	Gr/9
Pads (Arm/Disarm, Calibration, etc.)							
45	C-PADS-CNTR-IDEN	C-PADSCIM-	Centerline annotation	0	0.35	Y/2	Y/4
46	C-PADS-CNTR	C-PADSCTM-	Centerlines	7	0.25	R/1	R/3
47	C-PADS-IDEN	C-PADSIDM-	Pads - annotation	0	0.35	Y/2	Y/4
48	C-PADS-OTLN	C-PADSOTM-	Pad - outlines	0	0.50	C/4	C/7
49	C-PADS-SHLD	C-PADSSHM-	Shoulders with annotation	0	0.35	Y/2	Y/4
Demolition (used only in creating Existing/Demolition model files)							
56	C-STAT-DEMO-PHS1	C-----M-D----1	Demolition - phase 1	0	0.50	203	45
57	C-STAT-DEMO-PHS2	C-----M-D----2	Demolition - phase 2	0	0.50	83	42
58	C-STAT-DEMO-PHS3	C-----M-D----3	Demolition - phase 3	0	0.50	163	41

Note: V = Varies, NA = Not Applicable

Discipline: Civil

Model File Type: Airfield Pavement Marking Plan

Level #	Level/Layer Naming		Level/Layer Description	Graphics			
	AIA Format	ISO Format		Line Style	Line Width (mm)	AutoCAD Line Color/#	MicroStation Line Color/#
General Information							
1	C-ANNO-DIMS	C-----DIP-	Witness/extension lines, dimension terminators, dimension text	0	V	V	V
2	C-ANNO-KEYN	C-----KEP-	Reference keynotes with associated leaders	0	V	V	V
3	C-ANNO-NPLT	C-----NPP-	Non-plotting graphic information	V	0.18	B/5	B/1
4	C-ANNO-PATT	C-----PAP-	Miscellaneous patterning and hatching	0	0.18	Gr/8	Gr/9
5	C-ANNO-NOTE	C-----NOP-	General notes and general remarks	0	0.35	Y/2	Y/4
6	C-ANNO-SYMB	C-----SYP-	Miscellaneous symbols	V	0.35	M/6	M/5
7	C-ANNO-TEXT	C-----TEP-	Miscellaneous text and callouts with associated leaders	0	V	V	V
NA	C-ANNO-REFR	C-----RFP-	Reference files (AutoCAD users only, see Chapter 4)	NA	NA	NA	NA
Taxiway							
12	C-TAXI-CNTR	C-TAXICTM-	Centerline markings	0	0.25	R/1	R/3
13	C-TAXI-IDEN	C-TAXIIDM-	Annotation	0	0.35	Y/2	Y/4
14	C-TAXI-HOLD	C-TAXIHOM-	Holding lines	0	0.35	Y/2	Y/4
15	C-TAXI-EDGE	C-TAXIEDM-	Edge markings	0	0.50	C/4	C/7
16	C-TAXI-SHLD	C-TAXISHM-	Shoulder transverse stripes	0	0.35	Y/2	Y/4
Apron							
18	C-APRN-GRND	C-APRNGRM-	Grounding points	0	0.35	Y/2	Y/4
19	C-APRN-HOLD	C-APRNHOM-	Holding position markings	0	0.25	R/1	R/3
20	C-APRN-IDEN	C-APRNIDM-	Annotation	0	0.35	Y/2	Y/4
21	C-APRN-MOOR	C-APRNMOM-	Mooring points	0	0.35	Y/2	Y/4
22	C-APRN-MRKG	C-APRNMRM-	Apron markings	0	0.50	C/4	C/7
23	C-APRN-SHLD	C-APRNSHM-	Shoulder stripes	0	0.35	Y/2	Y/4
24	C-APRN-SECU	C-APRNSEM-	Security zone markings	0	0.25	R/1	R/3
Overrun Areas							
29	C-OVRN-SHLD	C-OVRNSHM-	Shoulder markings	0	0.50	C/4	C/7
Precision and Nonprecision Runways							
32	C-RUNW-BLST	C-RUNWBLM-	Blast pad and stopway markings	0	0.25	R/1	R/3
33	C-RUNW-DIST	C-RUNWDIM-	Fixed distance markings	0	0.25	R/1	R/3
34	C-RUNW-DISP	C-RUNWDISM-	Displaced threshold markings	0	0.25	R/1	R/3
35	C-RUNW-CNTR	C-RUNWCNM-	Centerline markings	0	0.25	R/1	R/3
36	C-RUNW-IDEN	C-RUNWIDM-	Runway numbers and letters	0	0.35	Y/2	Y/4
37	C-RUNW-SHLD	C-RUNWSHM-	Shoulder markings	0	0.35	M/6	M/5
38	C-RUNW-SIDE	C-RUNWSIM-	Side stripes	0	0.50	C/4	C/7
39	C-RUNW-TDZM	C-RUNWTDZM-	Touchdown zone markers	0	0.35	M/6	M/5
40	C-RUNW-THRS	C-RUNWTHM-	Threshold markers	0	0.35	M/6	M/5
Heliports							
41	C-HELI-BLST	C-HELIBLM-	Blast pad and stopway markings	0	0.25	R/1	R/3
42	C-HELI-DIST	C-HELIDIM-	Fixed distance markings	0	0.25	R/1	R/3
43	C-HELI-DISP	C-HELIDISM-	Displaced threshold markings	0	0.25	R/1	R/3
44	C-HELI-CNTR	C-HELICNM-	Centerline markings	0	0.25	R/1	R/3
45	C-HELI-IDEN	C-HELIIDM-	Heliport numbers and letters	0	0.35	Y/2	Y/4
46	C-HELI-SHLD	C-HELISHM-	Shoulder markings	0	0.35	M/6	M/5
47	C-HELI-SIDE	C-HELISIM-	Side stripes	0	0.50	C/4	C/7
48	C-HELI-TDZM	C-HELITDZM-	Touchdown zone markers	0	0.35	M/6	M/5
49	C-HELI-THRS	C-HELITHM-	Threshold markers	0	0.35	M/6	M/5
Demolition (used only in creating Existing/Demolition model files)							
56	C-STAT-DEMO-PHS1	C-----M-D----1	Demolition - phase 1	0	0.50	203	45
57	C-STAT-DEMO-PHS2	C-----M-D----2	Demolition - phase 2	0	0.50	83	42
58	C-STAT-DEMO-PHS3	C-----M-D----3	Demolition - phase 3	0	0.50	163	41

Note: V = Varies, NA = Not Applicable

Discipline: Civil

Model File Type: Domestic Water Plan

Level #	Level/Layer Naming		Level/Layer Description	Graphics			
	AIA Format	ISO Format		Line Style	Line Width (mm)	AutoCAD Line Color/#	MicroStation Line Color/#
General Information							
1	C-ANNO-DIMS	C-----DIP-	Witness/extension lines, dimension terminators, dimension text	0	V	V	V
2	C-ANNO-KEYN	C-----KEP-	Reference keynotes with associated leaders	0	V	V	V
3	C-ANNO-NPLT	C-----NPP-	Non-plotting graphic information	V	0.18	B/5	B/1
4	C-ANNO-PATT	C-----PAP-	Miscellaneous patterning and hatching	0	0.18	Gr/8	Gr/9
5	C-ANNO-NOTE	C-----NOP-	General notes and general remarks	0	0.35	Y/2	Y/4
6	C-ANNO-SYMB	C-----SYP-	Miscellaneous symbols	V	0.35	M/6	M/5
7	C-ANNO-TEXT	C-----TEP-	Miscellaneous text and callouts with associated leaders	0	V	V	V
NA	C-ANNO-REFR	C-----RFP-	Reference files (AutoCAD users only, see Chapter 4)	NA	NA	NA	NA
Alignments							
8	C-ALGN-DATA	C-ALGNDAM-	Alignment coordinates and curve data	0	0.25	G/3	G/2
9	C-ALGN-LINE	C-ALGNLIM-	Alignments	4	0.35	Y/2	Y/4
10	C-ALGN-STAT	C-ALGNSTM-	Alignment stationing and tick marks	0	0.25	G/3	G/2
Devices							
11	C-DOMW-DEVC	C-DOMWDEM-	Connectors, faucets, reducers, regulators, vents, intake points, tanks, taps, backflow preventers, and valves	0	0.35	M/6	M/5
12	C-DOMW-HYDR	C-DOMWWHYM-	Hydrants	0	0.25	R/1	R/3
13	C-DOMW-METR	C-DOMWMEM-	Meters	0	0.25	G/3	G/2
14	C-DOMW-NHYD	C-DOMWNHM-	Non-potable hydrants/flushing hydrants	0	0.25	R/1	R/3
Stations							
16	C-DOMW-PUMP	C-DOMWPUM-	Booster pump stations	0	0.35	M/6	M/5
17	C-DOMW-REDC	C-DOMWREM-	Pressure reducing stations	0	0.35	M/6	M/5
18	C-DOMW-STNS-IDEN	C-DOMWSIM-	Identifier tags, symbol modifier, and tex	0	0.35	Y/2	Y/4
Reservoirs							
19	C-DOMW-RSVR-IDEN	C-DOMWRIM-	Identifier tags, symbol modifier, and text	0	0.25	R/1	R/3
20	C-DOMW-RSVR	C-DOMWRSM-	Reservoirs	0	0.25	R/1	R/3
21	C-DOMW-TANK	C-DOMWTAM-	Water storage tanks	0	0.25	R/1	R/3
22	C-DOMW-WELL	C-DOMWWEM-	Water well houses	0	0.25	R/1	R/3
Pits							
26	C-DOMW-PITS-IDEN	C-DOMWPIM-	Identifier tags, symbol modifier, and text	0	0.25	R/1	R/3
27	C-DOMW-VENT	C-DOMWVEM-	Vent pits	0	0.25	G/3	G/2
28	C-DOMW-VLVE	C-DOMWVLM-	Valve pits/vaults	0	0.25	G/3	G/2
Piping							
32	C-DOMW-ABND	C-DOMWABM-	Abandoned piping	2	0.35	M/6	M/5
37	C-DOMW-FTTG	C-DOMWFTM-	Caps, cleanouts, crosses, and tees	0	0.35	M/6	M/5
40	C-DOMW-IDEN	C-DOMWIDM-	Identifier tags, symbol modifier, and text	0	0.35	Y/2	Y/4
43	C-DOMW-MAIN	C-DOMWMAM-	Main domestic water piping	WATERL	0.35	M/6	M/5
44	C-DOMW-NPOT	C-DOMWNPM-	Non-potable water piping	NONPOT	0.35	M/6	M/5
45	C-DOMW-FIRE	C-DOMWFIM-	Fire lines	FIRE	0.25	R/1	R/3
46	C-DOMW-SERV	C-DOMWSEM-	Domestic water service piping	0	0.35	M/6	M/5
47	C-DOMW-SIGN	C-DOMWSIM-	Surface markers/signs	0	0.25	R/1	R/3
Demolition (used only in creating Existing/Demolition model files)							
56	C-STAT-DEMO-PHS1	C-----M-D----1	Demolition - phase 1	0	0.50	203	45
57	C-STAT-DEMO-PHS2	C-----M-D----2	Demolition - phase 2	0	0.50	83	42
58	C-STAT-DEMO-PHS3	C-----M-D----3	Demolition - phase 3	0	0.50	163	41

Note: V = Varies, NA = Not Applicable

Discipline: Civil

Model File Type: Sanitary Sewer Plan

Level #	Level/Layer Naming		Level/Layer Description	Graphics			
	AIA Format	ISO Format		Line Style	Line Width (mm)	AutoCAD Line Color/#	MicroStation Line Color/#
General Information							
1	C-ANNO-DIMS	C-----DIP-	Witness/extension lines, dimension terminators, dimension text	0	V	V	V
2	C-ANNO-KEYN	C-----KEP-	Reference keynotes with associated leaders	0	V	V	V
3	C-ANNO-NPLT	C-----NPP-	Non-plotting graphic information	V	0.18	B/5	B/1
4	C-ANNO-PATT	C-----PAP-	Miscellaneous patterning and hatching	0	0.18	Gr/8	Gr/9
5	C-ANNO-NOTE	C-----NOP-	General notes and general remarks	0	0.35	Y/2	Y/4
6	C-ANNO-SYMB	C-----SYP-	Miscellaneous symbols	V	0.35	M/6	M/5
7	C-ANNO-TEXT	C-----TEP-	Miscellaneous text and callouts with associated leaders	0	V	V	V
NA	C-ANNO-REFR	C-----RFP-	Reference files (AutoCAD users only, see Chapter 4)	NA	NA	NA	NA
Alignments							
8	C-ALGN-DATA	C-ALGNDAM-	Alignment coordinates and curve data	0	0.25	G/3	G/2
9	C-ALGN-LINE	C-ALGNLIM-	Alignments	4	0.35	Y/2	Y/4
10	C-ALGN-STAT	C-ALGNSTM-	Alignment stationing and tick marks	0	0.25	G/3	G/2
Devices							
11	C-SSWR-DEVC	C-SSWRDEM-	Grease traps, grit chambers, flumes, neutralizers, oil/water separators, ejectors, and valves	0	0.35	M/6	M/5
12	C-SSWR-DEVC-IDEN	C-SSWRDIM-	Identifier tags, symbol modifier, and tex	0	0.35	M/6	M/5
Stations							
15	C-SSWR-PLNT	C-SSWRPLM-	Treatment plants	0	0.35	M/6	M/5
16	C-SSWR-PUMP	C-SSWRPUM-	Booster pump stations	0	0.35	M/6	M/5
18	C-SSWR-STNS-IDEN	C-SSWRSIM-	Identifier tags, symbol modifier, and tex	0	0.35	Y/2	Y/4
Reservoirs							
19	C-SSWR-RSVR-IDEN	C-SSWRRIM-	Identifier tags, symbol modifier, and text	0	0.25	G/3	G/2
20	C-SSWR-LAGN	C-SSWRLAM-	Lagoons	0	0.25	G/3	G/2
21	C-SSWR-TANK	C-SSWRTAM-	Septic tanks	0	0.25	G/3	G/2
Junction Boxes							
22	C-SSWR-JBOX	C-SSWRJBM-	Junction boxes and manholes	0	0.25	R/1	R/3
23	C-SSWR-JBOX-IDEN	C-SSWRJIM-	Identifier tags, symbol modifier, and tex	0	0.25	R/1	R/3
Filtration/Drainage Areas							
26	C-SSWR-FILT	C-SSWRFIM-	Filtration beds	0	0.25	G/3	G/2
27	C-SSWR-FILT-IDEN	C-SSWRFDM-	Identifier tags, symbol modifier, and text	0	0.25	G/3	G/2
28	C-SSWR-NITF	C-SSWRNIM-	Nitrification drain fields	0	0.25	G/3	G/2
29	C-SSWR-LEAC	C-SSWRLEM-	Leach field	0	0.25	G/3	G/2
Piping							
32	C-SSWR-ABND	C-SSWRABM-	Abandoned piping	2	0.35	M/6	M/5
33	C-SSWR-FLOW	C-SSWRFLM-	Flow direction arrows	0	0.35	M/6	M/5
37	C-SSWR-FTTG	C-SSWRFTM-	Caps and cleanouts	0	0.35	M/6	M/5
40	C-SSWR-IDEN	C-SSWRIDM-	Identifier tags, symbol modifier, and text	0	0.35	Y/2	Y/4
43	C-SSWR-MAIN	C-SSWRMAM-	Sanitary sewer piping	SSWAF	0.35	M/6	M/5
46	C-SSWR-SERV	C-SSWRSEM-	Sanitary sewer service piping	0	0.25	R/1	R/3
47	C-SSWR-SIGN	C-SSWRSIM-	Surface markers/signs	0	0.25	R/1	R/3
Demolition (used only in creating Existing/Demolition model files)							
56	C-STAT-DEMO-PHS1	C-----M-D----1	Demolition - phase 1	0	0.50	203	45
57	C-STAT-DEMO-PHS2	C-----M-D----2	Demolition - phase 2	0	0.50	83	42
58	C-STAT-DEMO-PHS3	C-----M-D----3	Demolition - phase 3	0	0.50	163	41

Note: V = Varies, NA = Not Applicable

Discipline: Civil

Model File Type: Storm Sewer Plan

Level #	Level/Layer Naming		Level/Layer Description	Graphics			
	AIA Format	ISO Format		Line Style	Line Width (mm)	AutoCAD Line Color#	MicroStation Line Color#
General Information							
1	C-ANNO-DIMS	C-----DIP-	Witness/extension lines, dimension terminators, dimension text	0	V	V	V
2	C-ANNO-KEYN	C-----KEP-	Reference keynotes with associated leaders	0	V	V	V
3	C-ANNO-NPLT	C-----NPP-	Non-plotting graphic information	V	0.18	B/5	B/1
4	C-ANNO-PATT	C-----PAP-	Miscellaneous patterning and hatching	0	0.18	Gr/8	Gr/9
5	C-ANNO-NOTE	C-----NOP-	General notes and general remarks	0	0.35	Y/2	Y/4
6	C-ANNO-SYMB	C-----SYP-	Miscellaneous symbols	V	0.35	M/6	M/5
7	C-ANNO-TEXT	C-----TEP-	Miscellaneous text and callouts with associated leaders	0	V	V	V
NA	C-ANNO-REFR	C-----RFP-	Reference files (AutoCAD users only, see Chapter 4)	NA	NA	NA	NA
Alignments							
8	C-ALGN-DATA	C-ALGNDAM-	Alignment coordinates and curve data	0	0.25	G/3	G/2
9	C-ALGN-LINE	C-ALGNLIM-	Alignments	4	0.35	Y/2	Y/4
10	C-ALGN-STAT	C-ALGNSTM-	Alignment stationing and tick marks	0	0.25	G/3	G/2
Devices							
11	C-STRM-DEVC	C-STRMDEM-	Downspouts, flumes, oil/water separators, and flap gate	0	0.35	M/6	M/5
Stations							
16	C-STRM-PUMP	C-STRMPUM-	Pump stations	0	0.35	M/6	M/5
17	C-STRM-FMON	C-STRMFMM-	Flow monitoring station	0	0.35	M/6	M/5
18	C-STRM-STNS-IDEN	C-STRMSIM-	Identifier tags, symbol modifier, and text	0	0.35	Y/2	Y/4
Reservoirs/Watersheds							
19	C-STRM-RSVR-IDEN	C-STRMRIM-	Identifier tags, symbol modifier, and text	0	0.25	G/3	G/2
20	C-STRM-LAGN	C-STRMLAM-	Lagoons, ponds, watersheds, and basins	0	0.25	G/3	G/2
21	C-STRM-AFFF	C-STRMAFM-	AFFF lagoon/detention pond	0	0.25	G/3	G/2
Drainage Structures							
22	C-STRM-MHOL	C-STRMMHM-	Manholes	0	0.25	R/1	R/3
26	C-STRM-DRAN-IDEN	C-STRMDRM-	Identifier tags, symbol modifier, and text	0	0.25	G/3	G/2
27	C-STRM-EROS	C-STRMERM-	Erosion control (riprap)	0	0.18	B/5	B/1
28	C-STRM-CHUT	C-STRMCHM-	Chutes and concrete erosion control structures	0	0.25	R/1	R/3
29	C-STRM-HDWL	C-STRMHDM-	Headwalls and endwalls	0	0.70	W/7	W/0
30	C-STRM-INLT	C-STRMINM-	Inlets (curb, surface, and catch basins)	0	0.25	G/3	G/2
Piping							
32	C-STRM-ABND	C-STRMABM-	Abandoned piping	2	0.35	M/6	M/5
33	C-STRM-FLOW	C-STRMFLM-	Flow direction arrows	0	0.35	M/6	M/5
37	C-STRM-FITG	C-STRMFTM-	Caps and cleanouts	0	0.35	M/6	M/5
40	C-STRM-IDEN	C-STRMIDM-	Identifier tags, symbol modifier, and text	0	0.35	Y/2	Y/4
42	C-STRM-CULV	C-STRMCLM-	Culverts	CULVRT	0.25	G/3	G/2
43	C-STRM-MAIN	C-STRMMAM-	Storm sewer piping	STRAF	0.35	M/6	M/5
44	C-STRM-SUBS	C-STRMSUM-	Subsurface drain piping	0	0.25	G/3	G/2
45	C-STRM-ROOF	C-STRMROM-	Roof drain line	0	0.25	G/3	G/2
46	C-STRM-SERV	C-STRMSEM-	Storm sewer service piping	0	0.25	R/1	R/3
47	C-STRM-SIGN	C-STRMSIM-	Surface markers/signs	0	0.25	R/1	R/3
Demolition (used only in creating Existing/Demolition model files)							
56	C-STAT-DEMO-PHS1	C-----M-D----1	Demolition - phase 1	0	0.50	203	45
57	C-STAT-DEMO-PHS2	C-----M-D----2	Demolition - phase 2	0	0.50	83	42
58	C-STAT-DEMO-PHS3	C-----M-D----3	Demolition - phase 3	0	0.50	163	41

Note: V = Varies, NA = Not Applicable

Discipline: Civil

Model File Type: Industrial Waste Water Plan

Level #	Level/Layer Naming		Level/Layer Description	Graphics			
	AIA Format	ISO Format		Line Style	Line Width (mm)	AutoCAD Line Color#	MicroStation Line Color#
General Information							
1	C-ANNO-DIMS	C-----DIP-	Witness/extension lines, dimension terminators, dimension text	0	V	V	V
2	C-ANNO-KEYN	C-----KEP-	Reference keynotes with associated leaders	0	V	V	V
3	C-ANNO-NPLT	C-----NPP-	Non-plotting graphic information	V	0.18	B/5	B/1
4	C-ANNO-PATT	C-----PAP-	Miscellaneous patterning and hatching	0	0.18	Gr/8	Gr/9
5	C-ANNO-NOTE	C-----NOP-	General notes and general remarks	0	0.35	Y/2	Y/4
6	C-ANNO-SYMB	C-----SYP-	Miscellaneous symbols	V	0.35	M/6	M/5
7	C-ANNO-TEXT	C-----TEP-	Miscellaneous text and callouts with associated leaders	0	V	V	V
NA	C-ANNO-REFR	C-----RFP-	Reference files (AutoCAD users only, see Chapter 4)	NA	NA	NA	NA
Alignments							
8	C-ALGN-DATA	C-ALGNDAM-	Alignment coordinates and curve data	0	0.25	G/3	G/2
9	C-ALGN-LINE	C-ALGNLIM-	Alignments	4	0.35	Y/2	Y/4
10	C-ALGN-STAT	C-ALGNSTM-	Alignment stationing and tick marks	0	0.25	G/3	G/2
Devices							
11	C-INDW-DEVC	C-INDWDEM-	Grit chambers, meters, flumes, neutralizers, oil/water separators, ejectors, tanks, and valves	0	0.35	M/6	M/5
Stations							
15	C-INDW-PLNT	C-INDWPLM-	Treatment plants	0	0.35	M/6	M/5
16	C-INDW-LIFT	C-INDWLIM-	Lift stations	0	0.35	M/6	M/5
18	C-INDW-STNS-IDEN	C-INDWSIM-	Identifier tags, symbol modifier, and text	0	0.35	Y/2	Y/4
Reservoirs							
19	C-INDW-RSVR-IDEN	C-INDWRIM-	Identifier tags, symbol modifier, and text	0	0.35	M/6	M/5
20	C-INDW-LAGN	C-INDWLAM-	Lagoons	0	0.35	M/6	M/5
Junction Boxes							
22	C-INDW-JBOX	C-INDWJBM-	Junction boxes and manholes	0	0.25	R/1	R/3
Piping							
32	C-INDW-ABND	C-INDWABM-	Abandoned piping	2	0.35	M/6	M/5
33	C-INDW-FLOW	C-INDWFLM-	Flow direction arrows	0	0.35	M/6	M/5
37	C-INDW-FTTG	C-INDWFTM-	Caps and cleanouts	0	0.35	M/6	M/5
40	C-INDW-IDEN	C-INDWIDM-	Identifier tags, symbol modifier, and text	0	0.35	Y/2	Y/4
43	C-INDW-MAIN	C-INDWMAM-	Main industrial waste water piping	IWASTE	0.35	M/6	M/5
46	C-INDW-SERV	C-INDWSEM-	Industrial waste water service piping	0	0.25	R/1	R/3
47	C-INDW-SIGN	C-INDWSIM-	Surface markers/signs	0	0.25	R/1	R/3
Demolition (used only in creating Existing/Demolition model files)							
56	C-STAT-DEMO-PHS1	C-----M-D----1	Demolition - phase 1	0	0.50	203	45
57	C-STAT-DEMO-PHS2	C-----M-D----2	Demolition - phase 2	0	0.50	83	42
58	C-STAT-DEMO-PHS3	C-----M-D----3	Demolition - phase 3	0	0.50	163	41

Note: V = Varies, NA = Not Applicable

Discipline: Civil

Model File Type: Natural Gas Utilities Plan

Level #	Level/Layer Naming		Level/Layer Description	Graphics			
	AIA Format	ISO Format		Line Style	Line Width (mm)	AutoCAD Line Color#	MicroStation Line Color#
General Information							
1	C-ANNO-DIMS	C-----DIP-	Witness/extension lines, dimension terminators, dimension text	0	V	V	V
2	C-ANNO-KEYN	C-----KEP-	Reference keynotes with associated leaders	0	V	V	V
3	C-ANNO-NPLT	C-----NPP-	Non-plotting graphic information	V	0.18	B/5	B/1
4	C-ANNO-PATT	C-----PAP-	Miscellaneous patterning and hatching	0	0.18	Gr/8	Gr/9
5	C-ANNO-NOTE	C-----NOP-	General notes and general remarks	0	0.35	Y/2	Y/4
6	C-ANNO-SYMB	C-----SYP-	Miscellaneous symbols	V	0.35	M/6	M/5
7	C-ANNO-TEXT	C-----TEP-	Miscellaneous text and callouts with associated leaders	0	V	V	V
NA	C-ANNO-REFR	C-----RFP-	Reference files (AutoCAD users only, see Chapter 4)	NA	NA	NA	NA
Alignments							
8	C-ALGN-DATA	C-ALGNDAM-	Alignment coordinates and curve data	0	0.25	G/3	G/2
9	C-ALGN-LINE	C-ALGNLIM-	Alignments	4	0.35	Y/2	Y/4
10	C-ALGN-STAT	C-ALGNSTM-	Alignment stationing and tick marks	0	0.25	G/3	G/2
Devices							
11	C-NGAS-DEVC	C-NGASDEM-	Hydrant fill points, lights, vents, markers, rectifiers, reducers, regulators, sources, tanks, drip pots, taps, and valves	0	0.35	M/6	M/5
12	C-NGAS-DEVC-IDEN	C-NGASDIM-	Identifier tags, symbol modifier, and text	0	0.35	M/6	M/5
13	C-NGAS-METR	C-NGASMEM-	Meters	0	0.25	G/3	G/2
Stations							
16	C-NGAS-PUMP	C-NGASPUM-	Compressor stations	0	0.35	M/6	M/5
17	C-NGAS-REDC	C-NGASREM-	Reducing stations	0	0.35	M/6	M/5
18	C-NGAS-STNS-IDEN	C-NGASSIM-	Identifier tags, symbol modifier, and text	0	0.35	Y/2	Y/4
Pits							
26	C-NGAS-PITS-IDEN	C-NGASPIM-	Identifier tags, symbol modifier, and text	0	0.25	R/1	R/3
27	C-NGAS-VENT	C-NGASVEM-	Vent pits	0	0.25	G/3	G/2
28	C-NGAS-VLVE	C-NGASVLM-	Valve pits/boxes	0	0.25	G/3	G/2
Piping							
32	C-NGAS-ABND	C-NGASABM-	Abandoned piping	2	0.35	M/6	M/5
33	C-NGAS-FLOW	C-NGASFLM-	Flow direction arrows	0	0.25	M/6	M/5
37	C-NGAS-FTTG	C-NGASFTM-	Caps, crosses, and tees	0	0.35	M/6	M/5
40	C-NGAS-IDEN	C-NGASIDM-	Identifier tags, symbol modifier, and text	0	0.35	Y/2	Y/4
43	C-NGAS-MAIN	C-NGASMAM-	Main natural gas piping	NTGASN	0.35	M/6	M/5
46	C-NGAS-SERV	C-NGASSEM-	Service piping	0	0.25	R/1	R/3
47	C-NGAS-SIGN	C-NGASSIM-	Surface markers/signs	0	0.25	R/1	R/3
Demolition (used only in creating Existing/Demolition model files)							
56	C-STAT-DEMO-PHS1	C-----M-D----1	Demolition - phase 1	0	0.50	203	45
57	C-STAT-DEMO-PHS2	C-----M-D----2	Demolition - phase 2	0	0.50	83	42
58	C-STAT-DEMO-PHS3	C-----M-D----3	Demolition - phase 3	0	0.50	163	41

Note: V = Varies, NA = Not Applicable

Discipline: Civil

Model File Type: Liquid Fuel Utilities Plan

Level #	Level/Layer Naming		Level/Layer Description	Graphics			
	AIA Format	ISO Format		Line Style	Line Width (mm)	AutoCAD Line Color#	MicroStation Line Color#
General Information							
1	C-ANNO-DIMS	C-----DIP-	Witness/extension lines, dimension terminators, dimension text	0	V	V	V
2	C-ANNO-KEYN	C-----KEP-	Reference keynotes with associated leaders	0	V	V	V
3	C-ANNO-NPLT	C-----NPP-	Non-plotting graphic information	V	0.18	B/5	B/1
4	C-ANNO-PATT	C-----PAP-	Miscellaneous patterning and hatching	0	0.18	Gr/8	Gr/9
5	C-ANNO-NOTE	C-----NOP-	General notes and general remarks	0	0.35	Y/2	Y/4
6	C-ANNO-SYMB	C-----SYP-	Miscellaneous symbols	V	0.35	M/6	M/5
7	C-ANNO-TEXT	C-----TEP-	Miscellaneous text and callouts with associated leaders	0	V	V	V
NA	C-ANNO-REFR	C-----RFP-	Reference files (AutoCAD users only, see Chapter 4)	NA	NA	NA	NA
Alignments							
8	C-ALGN-DATA	C-ALGNDAM-	Alignment coordinates and curve data	0	0.25	G/3	G/2
9	C-ALGN-LINE	C-ALGNLIM-	Alignments	4	0.35	Y/2	Y/4
10	C-ALGN-STAT	C-ALGNSTM-	Alignment stationing and tick marks	0	0.25	G/3	G/2
Devices							
11	C-FUEL-DEVC	C-FUELDEM-	Air eliminators, filter strainers, hydrant fill points, line vents, markers, oil/water separators, reducers, regulators, and valves	0	0.35	M/6	M/5
13	C-FUEL-METR	C-FUELMEM-	Meters	0	0.25	G/3	G/2
Stations							
16	C-FUEL-PUMP	C-FUELPU-	Booster pump stations	0	0.35	M/6	M/5
18	C-FUEL-STNS-IDEN	C-FUELSIM-	Identifier tags, symbol modifier, and text	0	0.35	Y/2	Y/4
Reservoirs							
21	C-FUEL-TANK	C-FUELTAM-	Fuel tanks	0	0.25	G/3	G/2
Junction Boxes							
22	C-FUEL-JBOX	C-FUELJBM-	Junction boxes, manholes, handholes, test boxes	0	0.25	R/1	R/3
Pits							
25	C-FUEL-HYDR	C-FUELHYM-	Hydrant control pits	0	0.25	G/3	G/2
26	C-FUEL-PITS-IDEN	C-FUELPI-	Identifier tags, symbol modifier, and text	0	0.25	R/1	R/3
27	C-FUEL-VENT	C-FUELVE-	Vent pits	0	0.25	G/3	G/2
28	C-FUEL-VLVE	C-FUELVLM-	Valve pits	0	0.25	G/3	G/2
29	C-FUEL-TRCH	C-FUELTRM-	Fuel line trench	0	0.25	G/3	G/2
Piping							
32	C-FUEL-ABND	C-FUELABM-	Abandoned piping	2	0.35	M/6	M/5
33	C-FUEL-FLOW	C-FUELFLM-	Flow direction arrows	0	0.35	M/6	M/5
36	C-FUEL-DEFL	C-FUELDEM-	Defueling piping	0	0.35	M/6	M/5
37	C-FUEL-FTTG	C-FUELFTM-	Caps, crosses, and tees	0	0.35	M/6	M/5
40	C-FUEL-IDEN	C-FUELIDM-	Identifier tags, symbol modifier, and text	0	0.35	Y/2	Y/4
43	C-FUEL-MAIN	C-FUELMAM-	Main fuel piping	LIQPET	0.35	M/6	M/5
46	C-FUEL-SERV	C-FUELSEM-	Service piping	0	0.35	M/6	M/5
Demolition (used only in creating Existing/Demolition model files)							
56	C-STAT-DEMO-PHS1	C-----M-D----1	Demolition - phase 1	0	0.50	203	45
57	C-STAT-DEMO-PHS2	C-----M-D----2	Demolition - phase 2	0	0.50	83	42
58	C-STAT-DEMO-PHS3	C-----M-D----3	Demolition - phase 3	0	0.50	163	41

Note: V = Varies, NA = Not Applicable

Discipline: Civil
Model File Type: Profiles

Level #	Level/Layer Naming		Level/Layer Description	Graphics			
	AIA Format	ISO Format		Line Style	Line Width (mm)	AutoCAD Line Color#	MicroStation Line Color#
General Information							
1	C-ANNO-DIMS	C-----DIP-	Witness/extension lines, dimension terminators, dimension text	0	V	V	V
2	C-ANNO-KEYN	C-----KEP-	Reference keynotes with associated leaders	0	V	V	V
3	C-ANNO-NPLT	C-----NPP-	Non-plotting graphic information	V	0.18	B/5	B/1
4	C-ANNO-PATT	C-----PAP-	Miscellaneous patterning and hatching	0	0.18	Gr/8	Gr/9
5	C-ANNO-NOTE	C-----NOP-	General notes and general remarks	0	0.35	Y/2	Y/4
6	C-ANNO-SYMB	C-----SYP-	Miscellaneous symbols	V	0.35	M/6	M/5
7	C-ANNO-TEXT	C-----TEP-	Miscellaneous text and callouts with associated leaders	0	V	V	V
NA	C-ANNO-REFR	C-----RFP-	Reference files (AutoCAD users only, see Chapter 4)	NA	NA	NA	NA
Alignments							
8	C-ALGN-DATA	C-ALGNDAM-	Alignment coordinates and curve data	0	0.25	G/3	G/2
9	C-ALGN-LINE	C-ALGNLIM-	Alignments	4	0.35	Y/2	Y/4
10	C-ALGN-STAT	C-ALGNSTM-	Alignment stationing and tick marks	0	0.25	G/3	G/2
Crossing Elements - Use symbology from previous model files							
Grade Linework							
41	C-GRAD-FNSH	C-GRADFNM-	Finished grade	0	0.50	C/4	C/7
44	C-GRAD-EXST	C-GRADEXM-	Existing grade, ground line	3	0.35	M/6	M/5
Grid Lines							
48	C-GRID-MAJR	C-GRIDMAM-	Major grid lines	0	0.25	R/1	R/3
49	C-GRID-MINR	C-GRIDMIM-	Minor grid lines	1	0.18	Gr/8	Gr/9
50	C-GRID-FRAM	C-GRIDFRM-	Frame	0	0.50	C/4	C/7
51	C-GRID-TEXT	C-GRIDTEM-	Border text, annotation	0	0.35	Y/2	Y/4
Demolition (used only in creating Existing/Demolition model files)							
56	C-STAT-DEMO-PHS1	C-----M-D----1	Demolition - phase 1	0	0.50	203	45
57	C-STAT-DEMO-PHS2	C-----M-D----2	Demolition - phase 2	0	0.50	83	42
58	C-STAT-DEMO-PHS3	C-----M-D----3	Demolition - phase 3	0	0.50	163	41

Note: V = Varies, NA = Not Applicable

Discipline: Civil
Model File Type: Elevations

Level #	Level/Layer Naming		Level/Layer Description	Graphics			
	AIA Format	ISO Format		Line Style	Line Width (mm)	AutoCAD Line Color/#	MicroStation Line Color/#
General Information							
1	C-ANNO-DIMS	C-----DIP-	Witness/extension lines, dimension terminators, dimension text	0	V	V	V
2	C-ANNO-KEYN	C-----KEP-	Reference keynotes with associated leaders	0	V	V	V
3	C-ANNO-NPLT	C-----NPP-	Non-plotting graphic information	V	0.18	B/5	B/1
4	C-ANNO-PATT	C-----PAP-	Miscellaneous patterning and hatching	0	0.18	Gr/8	Gr/9
5	C-ANNO-NOTE	C-----NOP-	General notes and general remarks	0	0.35	Y/2	Y/4
6	C-ANNO-SYMB	C-----SYP-	Miscellaneous symbols	V	0.35	M/6	M/5
7	C-ANNO-TEXT	C-----TEP-	Miscellaneous text and callouts with associated leaders	0	V	V	V
NA	C-ANNO-REFR	C-----RFP-	Reference files (AutoCAD users only, see Chapter 4)	NA	NA	NA	NA
Elevations							
38	C-ELEV-FIXT	C-ELEV-FIM-	Miscellaneous fixtures	0	0.35	Y/2	Y/4
40	C-ELEV-IDEN	C-ELEV-IDM-	Component identification numbers	0	0.35	Y/2	Y/4
41	C-ELEV-OTLN	C-ELEV-OTM-	Building outlines	0	0.35	M/6	M/5
42	C-ELEV-PATT	C-ELEV-PAM-	Textures and hatch patterns	0	0.18	Gr/8	Gr/9
44	C-ELEV-SIGN	C-ELEV-SIM-	Signage	0	0.25	R/1	R/3
Demolition (used only in creating Existing/Demolition model files)							
56	C-STAT-DEMO-PHS1	C-----M-D----1	Demolition - phase 1	0	0.50	203	45
57	C-STAT-DEMO-PHS2	C-----M-D----2	Demolition - phase 2	0	0.50	83	42
58	C-STAT-DEMO-PHS3	C-----M-D----3	Demolition - phase 3	0	0.50	163	41

Note: V = Varies, NA = Not Applicable

Discipline: Civil
Model File Type: X-Sections

Level #	Level/Layer Naming		Level/Layer Description	Graphics			
	AIA Format	ISO Format		Line Style	Line Width (mm)	AutoCAD Line Color/#	MicroStation Line Color/#
General Information							
1	C-ANNO-DIMS	C-----DIP-	Witness/extension lines, dimension terminators, dimension text	0	V	V	V
2	C-ANNO-KEYN	C-----KEP-	Reference keynotes with associated leaders	0	V	V	V
3	C-ANNO-NPLT	C-----NPP-	Non-plotting graphic information	V	0.18	B/5	B/1
4	C-ANNO-PATT	C-----PAP-	Miscellaneous patterning and hatching	0	0.18	Gr/8	Gr/9
5	C-ANNO-NOTE	C-----NOP-	General notes and general remarks	0	0.35	Y/2	Y/4
6	C-ANNO-SYMB	C-----SYP-	Miscellaneous symbols	V	0.35	M/6	M/5
7	C-ANNO-TEXT	C-----TEP-	Miscellaneous text and callouts with associated leaders	0	V	V	V
NA	C-ANNO-REFR	C-----RFP-	Reference files (AutoCAD users only, see Chapter 4)	NA	NA	NA	NA
Crossing Elements - Use symbology from previous model files							
Sections							
35	C-SECT-IDEN	C-SECTIDM-	Component identification numbers	0	0.35	Y/2	Y/4
36	C-SECT-MBND	C-SECTMBM-	Material beyond section cut	0	0.18	B/5	B/1
37	C-SECT-MCUT	C-SECTMCM-	Material cut by section	0	0.50	C/4	C/7
38	C-SECT-PATT	C-SECTPAM-	Textures and hatch patterns	0	0.18	Gr/8	Gr/9
Grade Linework							
41	C-GRAD-FNSH	C-GRADFNM-	Finished grade	0	0.50	C/4	C/7
44	C-GRAD-EXST	C-GRADEXM-	Existing grade, ground line	3	0.35	M/6	M/5
Grid Lines							
48	C-GRID-MAJR	C-GRIDMAM-	Major grid lines	0	0.25	R/1	R/3
49	C-GRID-MINR	C-GRIDMIM-	Minor grid lines	1	0.18	Gr/8	Gr/9
50	C-GRID-FRAM	C-GRIDFRM-	Frame	0	0.50	C/4	C/7
51	C-GRID-TEXT	C-GRIDTEM-	Border text, annotation	0	0.35	Y/2	Y/4
Demolition (used only in creating Existing/Demolition model files)							
56	C-STAT-DEMO-PHS1	C-----M-D----1	Demolition - phase 1	0	0.50	203	45
57	C-STAT-DEMO-PHS2	C-----M-D----2	Demolition - phase 2	0	0.50	83	42
58	C-STAT-DEMO-PHS3	C-----M-D----3	Demolition - phase 3	0	0.50	163	41

Note: V = Varies, NA = Not Applicable

Discipline: Civil
Model File Type: Details

Level #	Level/Layer Naming		Level/Layer Description	Graphics			
	AIA Format	ISO Format		Line Style	Line Width (mm)	AutoCAD Line Color/#	MicroStation Line Color/#
General Information							
1	C-ANNO-DIMS	C-----DIP-	Witness/extension lines, dimension terminators, dimension text	0	V	V	V
2	C-ANNO-KEYN	C-----KEP-	Reference keynotes with associated leaders	0	V	V	V
3	C-ANNO-NPLT	C-----NPP-	Non-plotting graphic information	V	0.18	B/5	B/1
4	C-ANNO-PATT	C-----PAP-	Miscellaneous patterning	0	0.18	Gr/8	Gr/9
5	C-ANNO-NOTE	C-----NOP-	General notes and general remarks	0	0.35	Y/2	Y/4
6	C-ANNO-SYMB	C-----SYP-	Reference bubbles, matchlines and breaklines	V	0.35	M/6	M/5
7	C-ANNO-TEXT	C-----TEP-	Detail title text, text and associated leaders, notes	V	V	V	V
Detail Information							
11	C-DETL-GRPH	C-DETLGRM-	Graphics, gridlines, non-text items	V	V	V	V
12	C-DETL-METR	C-DETLMEM-	Metric-specific dimensions and notes	0	0.25	G/3	G/2
13	C-DETL-INPD	C-DETLINM-	Inch-pound-specific dimensions and notes	0	0.25	R/1	R/3
Demolition							
56	C-STAT-DEMO-PHS1	C-----M-D----1	Demolition - phase 1	0	0.50	203	45
57	C-STAT-DEMO-PHS2	C-----M-D----2	Demolition - phase 2	0	0.50	83	42
58	C-STAT-DEMO-PHS3	C-----M-D----3	Demolition - phase 3	0	0.50	163	41

Note: V = Varies, NA = Not Applicable

Discipline: Landscape

Model File Type: Landscape Plan

Level #	Level/Layer Naming		Level/Layer Description	Graphics			
	AIA Format	ISO Format		Line Style	Line Width (mm)	AutoCAD Line Color/#	MicroStation Line Color/#
General Information							
1	L-ANNO-DIMS	L-----DIP-	Witness/extension lines, dimension terminators, dimension text	0	V	V	V
2	L-ANNO-KEYN	L-----KEP-	Reference keynotes with associated leaders	0	V	V	V
3	L-ANNO-NPLT	L-----NPP-	Non-plotting graphic information	V	0.18	B/5	B/1
4	L-ANNO-PATT	L-----PAP-	Miscellaneous patterning and hatching	0	0.18	Gr/8	Gr/9
5	L-ANNO-NOTE	L-----NOP-	General notes and general remarks	0	0.35	Y/2	Y/4
6	L-ANNO-SYMB	L-----SYP-	Miscellaneous symbols	V	0.35	M/6	M/5
7	L-ANNO-TEXT	L-----TEP-	Miscellaneous text and callouts with associated leaders	0	V	V	V
NA	L-ANNO-REFR	L-----RFP-	Reference files (AutoCAD users only, see Chapter 4)	NA	NA	NA	NA
Site Improvements							
11	L-SITE-BRDG	L-SITEBRM-	Bridges	0	0.35	22	22
12	L-SITE-DECK	L-SITEDEM-	Decks	0	0.35	232	107
13	L-SITE-FENC	L-SITEFEM-	Fencing	0	0.35	Y/2	Y/4
14	L-SITE-FURN	L-SITEFUM-	Furnishings	0	0.50	C/4	C/7
15	L-SITE-IDEN	L-SITEIDM-	Annotation	0	0.35	M/6	M/5
16	L-SITE-PLAY	L-SITEPLM-	Play structures	0	0.35	Y/2	Y/4
17	L-SITE-POOL	L-SITEPOM-	Pools and spas	0	0.35	162	33
18	L-SITE-ROCK	L-SITEROM-	Boulders and cobble	0	0.25	R/1	R/3
19	L-SITE-SPRT	L-SITESPM-	Sports fields	0	0.35	Y/2	Y/4
20	L-SITE-WALK	L-SITEWAM-	Walks and steps	0	V	V	V
21	L-SITE-RTWL	L-SITERTM-	Retaining walls	0	0.50	C/4	C/7
Landscape Plants							
23	L-PLNT-BEDS	L-PLNTBEM-	Planting beds	0	0.35	M/6	M/5
24	L-PLNT-TURF	L-PLNTTUM-	Lawn areas (turfing limits)	0	0.50	23	46
25	L-PLNT-MLCH	L-PLNTMLM-	Mulches - organic and inorganic	0	0.25	G/3	G/2
26	L-PLNT-GRND	L-PLNTGRM-	Groundcover and vines	0	0.35	82	18
27	L-PLNT-IDEN	L-PLNTIDM-	Annotation	0	0.35	M/6	M/5
28	L-PLNT-PLTS	L-PLNTPLM-	Planting plants (e.g., ornamental annuals and perennials)	0	0.50	83	42
29	L-PLNT-BUSH-LINE	L-PLNTBLM-	Bush and shrub line	0	0.50	83	42
30	L-PLNT-BUSH	L-PLNTBUM-	Bushes and shrubs (e.g., evergreen, deciduous)	0	0.50	83	42
31	L-PLNT-TREE-LINE	L-PLNTTLM-	Tree line	TREEL	0.50	83	42
32	L-PLNT-TREE	L-PLNTTRM-	Trees (e.g., evergreen, deciduous, etc.)	0	0.50	83	42
33	L-PLNT-SPRG	L-PLNTSPM-	Sprigs	0	0.25	G/3	G/2
34	L-PLNT-CTNR	L-PLNTCTM-	Containers or planters	0	0.25	R/1	R/3
35	L-PLNT-SHAD	L-PLNTSHM-	Shadow areas	0	0.18	B/5	B/1
Demolition (used only in creating Existing/Demolition model files)							
56	L-STAT-DEMO-PHS1	L-----M-D----1	Demolition - phase 1	0	0.50	203	45
57	L-STAT-DEMO-PHS2	L-----M-D----2	Demolition - phase 2	0	0.50	83	42
58	L-STAT-DEMO-PHS3	L-----M-D----3	Demolition - phase 3	0	0.50	163	41

Note: V = Varies, NA = Not Applicable

Discipline: Landscape
Model File Type: Irrigation Plan

Level #	Level/Layer Naming		Level/Layer Description	Graphics			
	AIA Format	ISO Format		Line Style	Line Width (mm)	AutoCAD Line Color/#	MicroStation Line Color/#
General Information							
1	L-ANNO-DIMS	L-----DIP-	Witness/extension lines, dimension terminators, dimension text	0	V	V	V
2	L-ANNO-KEYN	L-----KEP-	Reference keynotes with associated leaders	0	V	V	V
3	L-ANNO-NPLT	L-----NPP-	Non-plotting graphic information	V	0.18	B/5	B/1
4	L-ANNO-PATT	L-----PAP-	Miscellaneous patterning and hatching	0	0.18	Gr/8	Gr/9
5	L-ANNO-NOTE	L-----NOP-	General notes and general remarks	0	0.35	Y/2	Y/4
6	L-ANNO-SYMB	L-----SYP-	Miscellaneous symbols	V	0.35	M/6	M/5
7	L-ANNO-TEXT	L-----TEP-	Miscellaneous text and callouts with associated leaders	0	V	V	V
NA	L-ANNO-REFR	L-----RFP-	Reference files (AutoCAD users only, see Chapter 4)	NA	NA	NA	NA
Irrigation System							
25	L-IRRG-COVR	L-IRRGCOM-	Irrigation coverage, spray distribution patterns	0	0.18	B/5	B/1
26	L-IRRG-EQPM	L-IRRGEQM-	Equipment (e.g., controllers, valves, RPBPs, etc.)	0	0.35	M/6	M/5
27	L-IRRG-IDEN	L-IRRGIDM-	Annotation	0	0.35	Y/2	Y/4
28	L-IRRG-PIPE	L-IRRGPIM-	Piping	LAWNSP	0.35	M/6	M/5
31	L-IRRG-SPKL	L-IRRGSPM-	Sprinklers	0	0.35	M/6	M/5
34	L-IRRG-HEAD	L-IRRGHEM-	Irrigation heads, bubblers, and drip irrigation emitter:	0	0.25	R/1	R/3
Demolition (used only in creating Existing/Demolition model files)							
56	L-STAT-DEMO-PHS1	L-----M-D----1	Demolition - phase 1	0	0.50	203	45
57	L-STAT-DEMO-PHS2	L-----M-D----2	Demolition - phase 2	0	0.50	83	42
58	L-STAT-DEMO-PHS3	L-----M-D----3	Demolition - phase 3	0	0.50	163	41

Note: V = Varies, NA = Not Applicable

Discipline: Landscape

Model File Type: Details

Level #	Level/Layer Naming		Level/Layer Description	Graphics			
	AIA Format	ISO Format		Line Style	Line Width (mm)	AutoCAD Line Color/#	MicroStation Line Color/#
General Information							
1	L-ANNO-DIMS	L-----DIP-	Witness/extension lines, dimension terminators, dimension text	0	V	V	V
2	L-ANNO-KEYN	L-----KEP-	Reference keynotes with associated leaders	0	V	V	V
3	L-ANNO-NPLT	L-----NPP-	Non-plotting graphic information	V	0.18	B/5	B/1
4	L-ANNO-PATT	L-----PAP-	Miscellaneous patterning	0	0.18	Gr/8	Gr/9
5	L-ANNO-NOTE	L-----NOP-	General notes and general remarks	0	0.35	Y/2	Y/4
6	L-ANNO-SYMB	L-----SYP-	Reference bubbles, matchlines and breaklines	V	0.35	M/6	M/5
7	L-ANNO-TEXT	L-----TEP-	Detail title text, text and associated leaders, notes	V	V	V	V
Detail Information							
11	L-DETL-GRPH	L-DETLGRM-	Graphics, gridlines, non-text items	V	V	V	V
12	L-DETL-METR	L-DETLMEM-	Metric-specific dimensions and notes	0	0.25	G/3	G/2
13	L-DETL-INPD	L-DETLINM-	Inch-pound-specific dimensions and notes	0	0.25	R/1	R/3
Demolition							
56	L-STAT-DEMO-PHS1	L-----M-D----1	Demolition - phase 1	0	0.50	203	45
57	L-STAT-DEMO-PHS2	L-----M-D----2	Demolition - phase 2	0	0.50	83	42
58	L-STAT-DEMO-PHS3	L-----M-D----3	Demolition - phase 3	0	0.50	163	41

Note: V = Varies, NA = Not Applicable

Discipline: Structural

Model File Type: Foundation Plan

Level #	Level/Layer Naming		Level/Layer Description	Graphics			
	AIA Format	ISO Format		Line Style	Line Width (mm)	AutoCAD Line Color/#	MicroStation Line Color/#
General Information							
1	S-ANNO-DIMS	S-----DIP-	Witness/extension lines, dimension terminators, dimension text	0	V	V	V
2	S-ANNO-KEYN	S-----KEP-	Reference keynotes with associated leaders	0	V	V	V
3	S-ANNO-NPLT	S-----NPP-	Non-plotting graphic information	V	0.18	B/5	B/1
4	S-ANNO-PATT	S-----PAP-	Miscellaneous patterning and hatching	0	0.18	Gr/8	Gr/9
5	S-ANNO-NOTE	S-----NOP-	General notes and general remarks	0	0.35	Y/2	Y/4
6	S-ANNO-SYMB	S-----SYP-	Miscellaneous symbols	V	0.35	M/6	M/5
7	S-ANNO-TEXT	S-----TEP-	Miscellaneous text and callouts with associated leaders	0	V	V	V
NA	S-ANNO-REFR	S-----RFP-	Reference files (AutoCAD users only, see Chapter 4)	NA	NA	NA	NA
Foundation							
11	S-FNDN-CNTR	S-FNDNCNM-	Beam centerlines	7	0.18	B/5	B/1
16	S-FNDN-FTNG	S-FNDNFTM-	Footings	0, 2	0.50	C/4	C/7
17	S-FNDN-GRBM	S-FNDNGRM-	Grade beams	0, 2	0.50	C/4	C/7
18	S-FNDN-PEDS	S-FNDNPEM-	Column pedestals	0, 2	0.50	C/4	C/7
19	S-FNDN-PILE	S-FNDNPIM-	Piles (steel sheet, concrete, wood), piers, caisson piers, drilled piers	0, 2	0.35	Y/2	Y/4
20	S-FNDN-RBAR	S-FNDNRBM-	Foundation reinforcing	0, 2	0.70	W/7	W/0
Slabs							
21	S-SLAB-OPEN	S-SLABOPM-	Openings and penetrations	0, 2	0.25	R/1	R/3
26	S-SLAB-EDGE	S-SLABEDM-	Edge of slab	0, 2	0.35	Y/2	Y/4
28	S-SLAB-RBAR	S-SLABRBM-	Slab reinforcing	0, 2	0.70	W/7	W/0
Grating							
30	S-GRAT-ELEV	S-GRATELM-	Elevated grating (catwalks)	0, 2	0.25	G/3	G/2
31	S-GRAT-FLOR	S-GRATFLM-	Floor grating	0, 2	0.25	G/3	G/2
Joints							
33	S-JOIN-CNST	S-JOINCNM-	Construction joints	0	0.25	G/3	G/2
34	S-JOIN-CTRL	S-JOINCTM-	Control/expansion joints	0	0.25	R/1	R/3
Miscellaneous Supports							
35	S-SPPT-MISC	S-SPPTMIM-	Miscellaneous fasteners, anchor bolts, supports	0, 2	0.25	G/3	G/2
36	S-SPPT-SHPS	S-SPPTSHM-	Miscellaneous shapes, plates	0, 2	0.25	G/3	G/2
Stairs and Elevators							
38	S-STRS-FRAM	S-STRSFRM-	Stair/elevator framing	0, 2	0.35	M/6	M/5
39	S-STRS-LADD	S-STRSLAM-	Ladders, ladder handrails, safety guard, grab bars	0, 2	0.25	G/3	G/2
40	S-STRS-RBAR	S-STRSRBM-	Stair reinforcing	0, 2	0.70	W/7	W/0
Walls							
43	S-WALL-CONC	S-WALLCOM-	Concrete walls	0, 2	0.35	Y/2	Y/4
44	S-WALL-LOAD	S-WALLLOM-	Load bearing CMU walls	0, 2	0.35	Y/2	Y/4
45	S-WALL-NONL	S-WALLNOM-	Non-load bearing CMU walls	0, 2	0.35	M/6	M/5
46	S-WALL-PCST	S-WALLPCM-	Precast walls	0, 2	0.35	Y/2	Y/4
47	S-WALL-STUD	S-WALLSTM-	Stud walls	0, 2	0.35	Y/2	Y/4
48	S-WALL-RBAR	S-WALLRBM-	Wall reinforcing	0, 2	0.70	W/7	W/0
Pads							
49	S-PADS-EQPM	S-PADSEQM-	Equipment pads	0, 2	0.35	M/6	M/5
Demolition (used only in creating Existing/Demolition model files)							
56	S-STAT-DEMO-PHS1	S-----M-D----1	Demolition - phase 1	0	0.50	203	45
57	S-STAT-DEMO-PHS2	S-----M-D----2	Demolition - phase 2	0	0.50	83	42
58	S-STAT-DEMO-PHS3	S-----M-D----3	Demolition - phase 3	0	0.50	163	41

Note: V = Varies, NA = Not Applicable

Discipline: Structural

Model File Type: Framing Plan

Level #	Level/Layer Naming		Level/Layer Description	Graphics			
	AIA Format	ISO Format		Line Style	Line Width (mm)	AutoCAD Line Color#	MicroStation Line Color#
General Information							
1	S-ANNO-DIMS	S-----DIP-	Witness/extension lines, dimension terminators, dimension text, welding symbols	0	V	V	V
2	S-ANNO-KEYN	S-----KEP-	Reference keynotes with associated leaders	0	V	V	V
3	S-ANNO-NPLT	S-----NPP-	Non-plotting graphic information	V	0.18	B/5	B/1
4	S-ANNO-PATT	S-----PAP-	Miscellaneous patterning and hatching	0	0.18	Gr/8	Gr/9
5	S-ANNO-NOTE	S-----NOP-	General notes and general remarks	0	0.35	Y/2	Y/4
6	S-ANNO-SYMB	S-----SYP-	Miscellaneous symbols	V	0.35	M/6	M/5
7	S-ANNO-TEXT	S-----TEP-	Miscellaneous text and callouts with associated leaders	0	V	V	V
NA	S-ANNO-REFR	S-----RFP-	Reference files (AutoCAD users only, see Chapter 4)	NA	NA	NA	NA
Beams							
11	S-BEAM-CNTR	S-BEAMCNM-	Beam centerlines	7	0.18	B/5	B/1
12	S-BEAM-PRIM	S-BEAMPRM-	Primary beams, girders	0, 2	0.50	C/4	C/7
13	S-BEAM-SECD	S-BEAMSCM-	Secondary beams, girders	0, 2	0.35	M/6	M/5
Bracing							
16	S-BRAC-LATL	S-BRACLAM-	Lateral bracing	0, 2	0.35	Y/2	Y/4
17	S-BRAC-SHEA	S-BRACSHM-	Shear walls	0, 2	0.35	Y/2	Y/4
18	S-BRAC-VERT	S-BRACVEM-	Vertical bracing	0, 2	0.35	Y/2	Y/4
Deck							
19	S-DECK-FLOR	S-DECKFLM-	Floor deck	0, 2	0.25	G/3	G/2
20	S-DECK-RBAR	S-DECKRBM-	Deck/slab reinforcing	0, 2	0.70	W/7	W/0
21	S-DECK-OPEN	S-DECKOPM-	Openings and penetrations	0, 2	0.25	R/1	R/3
22	S-DECK-ROOF	S-DECKROM-	Roof deck	0	0.25	G/3	G/2
Open Web Joists							
23	S-JOIS-PRIM	S-JOISPRM-	Primary joists	0, 2	0.50	C/4	C/7
24	S-JOIS-SECD	S-JOISSCM-	Secondary joists	0, 2	0.35	M/6	M/5
25	S-JOIS-BRDG	S-JOISBRM-	Bridging	2	0.25	R/1	R/3
Miscellaneous Metal							
29	S-METL-MISC	S-METLMIM-	Miscellaneous metal	0, 2	0.35	M/6	M/5
Joints							
33	S-JOIN-CNST	S-JOINCNM-	Construction joints	0	0.25	G/3	G/2
34	S-JOIN-CTRL	S-JOINCTM-	Control/expansion joints	0	0.25	R/1	R/3
Miscellaneous Supports							
35	S-SPPT-MISC	S-SPPTMIM-	Miscellaneous fasteners, anchor bolts, supports	0, 2	0.25	G/3	G/2
36	S-SPPT-SHPS	S-SPPTSHM-	Miscellaneous shapes, plates	0, 2	0.25	G/3	G/2
Stairs and Elevators							
38	S-STRS-FRAM	S-STRSFRM-	Stair/elevator framing	0, 2	0.35	M/6	M/5
39	S-STRS-LADD	S-STRSLAM-	Ladders, ladder handrails, safety guard, grab bars	0, 2	0.25	G/3	G/2
40	S-STRS-RBAR	S-STRSRBM-	Stair reinforcing	0, 2	0.70	W/7	W/0
Trusses							
41	S-TRUS-PRIM	S-TRUSPRM-	Primary trusses	0, 2	0.50	C/4	C/7
42	S-TRUS-SECD	S-TRUSSCM-	Secondary trusses	0, 2	0.35	M/6	M/5
Walls							
43	S-WALL-CONC	S-WALLCOM-	Concrete walls	0, 2	0.35	Y/2	Y/4
44	S-WALL-LOAD	S-WALLLOM-	Load bearing CMU walls	0, 2	0.35	Y/2	Y/4
45	S-WALL-NONL	S-WALLNOM-	Non-load bearing CMU walls	0, 2	0.35	M/6	M/5
46	S-WALL-PCST	S-WALLPCM-	Precast walls	0, 2	0.35	Y/2	Y/4
47	S-WALL-STUD	S-WALLSTM-	Stud walls	0, 2	0.35	Y/2	Y/4
48	S-WALL-RBAR	S-WALLRBM-	Wall reinforcing	0, 2	0.70	W/7	W/0
Demolition (used only in creating Existing/Demolition model files)							
56	S-STAT-DEMO-PHS1	S-----M-D----1	Demolition - phase 1	0	0.50	203	45
57	S-STAT-DEMO-PHS2	S-----M-D----2	Demolition - phase 2	0	0.50	83	42
58	S-STAT-DEMO-PHS3	S-----M-D----3	Demolition - phase 3	0	0.50	163	41

Note: V = Varies, NA = Not Applicable

Discipline: Structural

Model File Type: Column Plan

Level #	Level/Layer Naming		Level/Layer Description	Graphics			
	AIA Format	ISO Format		Line Style	Line Width (mm)	AutoCAD Line Color/#	MicroStation Line Color/#
General Information							
1	S-ANNO-DIMS	S-----DIP-	Witness/extension lines, dimension terminators, dimension text	0	V	V	V
2	S-ANNO-KEYN	S-----KEP-	Reference keynotes with associated leaders	0	V	V	V
3	S-ANNO-NPLT	S-----NPP-	Non-plotting graphic information	V	0.18	B/5	B/1
4	S-ANNO-PATT	S-----PAP-	Miscellaneous patterning and hatching	0	0.18	Gr/8	Gr/9
5	S-ANNO-NOTE	S-----NOP-	General notes and general remarks	0	0.35	Y/2	Y/4
6	S-ANNO-SYMB	S-----SYP-	Miscellaneous symbols	V	0.35	M/6	M/5
7	S-ANNO-TEXT	S-----TEP-	Miscellaneous text and callouts with associated leaders	0	V	V	V
NA	S-ANNO-REFR	S-----RFP-	Reference files (AutoCAD users only, see Chapter 4)	NA	NA	NA	NA
Grid Lines							
8	S-GRID-IDEN	S-GRIDIDM-	Column I.D. tags	0	0.25	R/1	R/3
9	S-GRID-HORZ	S-GRIDHOM-	Primary grid lines (horizontal)	7	0.18	B/5	B/1
10	S-GRID-VERT	S-GRIDVEM-	Primary grid lines (vertical)	7	0.18	B/5	B/1
11	S-GRID-MSC1	S-GRIDM1M-	Miscellaneous grid lines (Type 1)	0	0.18	Gr/8	Gr/9
12	S-GRID-MSC2	S-GRIDM2M-	Miscellaneous grid lines (Type 2)	0	0.18	Gr/8	Gr/9
13	S-GRID-MSC3	S-GRIDM3M-	Miscellaneous grid lines (Type 3)	0	0.18	Gr/8	Gr/9
14	S-GRID-MSC4	S-GRIDM4M-	Miscellaneous grid lines (Type 4)	0	0.18	Gr/8	Gr/9
Columns							
16	S-COLS-CNTR	S-COLSCNM-	Column centerlines/working lines	7	0.18	10	10
17	S-COLS-PRIM	S-COLSPRM-	Primary columns	0	0.35	M/6	M/5
18	S-COLS-SCND	S-COLSSCM-	Secondary columns	0	0.35	Y/2	Y/4
19	S-COLS-MSC1	S-COLSM1M-	Miscellaneous columns (Type 1)	0	0.35	22	22
20	S-COLS-MSC2	S-COLSM2M-	Miscellaneous columns (Type 2)	0	0.35	22	22
21	S-COLS-MSC3	S-COLSM3M-	Miscellaneous columns (Type 3)	0	0.35	22	22
22	S-COLS-MSC4	S-COLSM4M-	Miscellaneous columns (Type 4)	0	0.35	22	22
Demolition (used only in creating Existing/Demolition model files)							
56	S-STAT-DEMO-PHS1	S-----M-D----1	Demolition - phase 1	0	0.50	203	45
57	S-STAT-DEMO-PHS2	S-----M-D----2	Demolition - phase 2	0	0.50	83	42
58	S-STAT-DEMO-PHS3	S-----M-D----3	Demolition - phase 3	0	0.50	163	41

Note: V = Varies, NA = Not Applicable

Discipline: Structural

Model File Type: Non-Building Structures

Level #	Level/Layer Naming		Level/Layer Description	Graphics			
	AIA Format	ISO Format		Line Style	Line Width (mm)	AutoCAD Line Color#	MicroStation Line Color#
General Information							
1	S-ANNO-DIMS	S-----DIP-	Witness/extension lines, dimension terminators, dimension text, welding symbols	0	V	V	V
2	S-ANNO-KEYN	S-----KEP-	Reference keynotes with associated leaders	0	V	V	V
3	S-ANNO-NPLT	S-----NPP-	Non-plotting graphic information	V	0.18	B/5	B/1
4	S-ANNO-PATT	S-----PAP-	Miscellaneous patterning and hatching	0	0.18	Gr/8	Gr/9
5	S-ANNO-NOTE	S-----NOP-	General notes and general remarks	0	0.35	Y/2	Y/4
6	S-ANNO-SYMB	S-----SYP-	Miscellaneous symbols	V	0.35	M/6	M/5
7	S-ANNO-TEXT	S-----TEP-	Miscellaneous text and callouts with associated leaders	0	V	V	V
NA	S-ANNO-REFR	S-----RFP-	Reference files (AutoCAD users only, see Chapter 4)	NA	NA	NA	NA
Features							
9	S-FEAT-GENL	S-FEATGEM-	General features (miscellaneous items)	0, 2	0.35	M/6	M/5
10	S-FEAT-CMUW	S-FEATCMM-	CMU outline (no patterning)	0, 2	0.35	Y/2	Y/4
11	S-FEAT-CNTR	S-FEATCNM-	Feature centerlines	7	0.18	B/5	B/1
15	S-FEAT-CONC	S-FEATCOM-	Concrete outline (no patterning)	0, 2	0.35	M/6	M/5
20	S-FEAT-WOOD	S-FEATWOM-	Wood outline (no patterning)	0, 2	0.35	Y/2	Y/4
Foundation							
19	S-FNDN-PILE	S-FNDNPIM-	Piles (steel sheet, concrete, wood), piers, caisson piers, drilled pier:	0, 2	0.35	Y/2	Y/4
Openings							
21	S-OPEN-MISC	S-OPENMIM-	Openings and penetrations	0, 2	0.25	R/1	R/3
Piping							
25	S-PIPE-MISC	S-PIPEMIM-	Miscellaneous piping/culverts	0, 2	0.35	Y/2	Y/4
26	S-PIPE-GATE	S-PIPEGAM-	Gates (flap gates, sluice gates, other)	0, 2	0.25	G/3	G/2
27	S-PIPE-TRSH	S-PIPETRM-	Trash racks	0, 2	0.25	G/3	G/2
Grating							
30	S-GRAT-ELEV	S-GRATELM-	Elevated grating (catwalks)	0, 2	0.25	G/3	G/2
31	S-GRAT-FLOR	S-GRATFLM-	Floor/surface grating, manhole covers/frames	0, 2	0.25	G/3	G/2
32	S-GRAT-SUBS	S-GRATSUM-	Subsurface grating	0, 2	0.25	G/3	G/2
Joints							
33	S-JOIN-CNST	S-JOINCNM-	Construction joints	0	0.25	G/3	G/2
34	S-JOIN-CTRL	S-JOINCTM-	Control/expansion joints, joint materials (e.g., felt), vapor barrier, waterstops, other	0	0.25	R/1	R/3
Miscellaneous Supports							
35	S-SPPT-MISC	S-SPPTMIM-	Miscellaneous fasteners, anchor bolts, supports	0, 2	0.25	G/3	G/2
36	S-SPPT-SHPS	S-SPPTSHM-	Miscellaneous shapes, plates	0, 2	0.25	G/3	G/2
Stairs and Elevators							
38	S-STRS-FRAM	S-STRSFRM-	Stair/elevator framing	0, 2	0.35	M/6	M/5
39	S-STRS-LADD	S-STRSLAM-	Ladders, ladder handrails, safety guard, grab bars	0, 2	0.25	G/3	G/2
Reinforcing							
40	S-REIN-RBAR	S-REINRBM-	Rebar, welded wire mesh	0, 2	0.70	W/7	W/0
Safety Barriers							
42	S-SAFE-HRAL	S-SAFEHRM-	Handrails	0	0.25	G/3	G/2
43	S-SAFE-FENC	S-SAFEFEM-	Fencing	0	0.25	G/3	G/2
Grade Lines							
45	S-GRDL-FNGR	S-GRDLFNM-	Finished grade	0	0.35	Y/2	Y/4
46	S-GRDL-EXGL	S-GRDLEXM-	Existing ground	3	0.25	G/3	G/2
47	S-GRDL-WATR	S-GRDLWAM-	Water surface	0	0.25	G/3	G/2
Demolition (used only in creating Existing/Demolition model files)							
56	S-STAT-DEMO-PHS1	S-----M-D----1	Demolition - phase 1	0	0.50	203	45
57	S-STAT-DEMO-PHS2	S-----M-D----2	Demolition - phase 2	0	0.50	83	42
58	S-STAT-DEMO-PHS3	S-----M-D----3	Demolition - phase 3	0	0.50	163	41

Note: V = Varies, NA = Not Applicable

Discipline: Structural
Model File Type: Elevations

Level #	Level/Layer Naming		Level/Layer Description	Graphics			
	AIA Format	ISO Format		Line Style	Line Width (mm)	AutoCAD Line Color/#	MicroStation Line Color/#
General Information							
1	S-ANNO-DIMS	S-----DIP-	Witness/extension lines, dimension terminators, dimension text	0	V	V	V
2	S-ANNO-KEYN	S-----KEP-	Reference keynotes with associated leaders	0	0.35	Y/2	Y/4
3	S-ANNO-NPLT	S-----NPP-	Non-plotting graphic information	V	0.18	B/5	B/1
4	S-ANNO-PATT	S-----PAP-	Miscellaneous patterning and hatching	0	0.18	Gr/8	Gr/9
5	S-ANNO-NOTE	S-----NOP-	General notes and general remarks	0	0.35	Y/2	Y/4
6	S-ANNO-SYMB	S-----SYP-	Miscellaneous symbols	V	0.35	M/6	M/5
7	S-ANNO-TEXT	S-----TEP-	Miscellaneous text and callouts with associated leaders	0	0.35	Y/2	Y/4
NA	S-ANNO-REFR	S-----RFP-	Reference files (AutoCAD users only, see Chapter 4)	NA	NA	NA	NA
Beams							
11	S-BEAM-CNTR	S-BEAMCNM-	Beam centerlines	7	0.18	B/5	B/1
12	S-BEAM-PRIM	S-BEAMPRM-	Primary beams/girders outlines	0, 2	0.50	C/4	C/7
13	S-BEAM-SECD	S-BEAMSCM-	Secondary beams/girders outlines	0, 2	0.35	M/6	M/5
Joints							
33	S-JOIN-CNST	S-JOINCNM-	Construction joints	0	0.25	G/3	G/2
34	S-JOIN-CTRL	S-JOINCTM-	Control/expansion joints	0	0.25	R/1	R/3
Miscellaneous Supports							
35	S-SPPT-MISC	S-SPPTMIM-	Miscellaneous fasteners, anchor bolts, supports	0, 2	0.25	G/3	G/2
36	S-SPPT-SHPS	S-SPPTSHM-	Miscellaneous shapes, plates	0, 2	0.25	G/3	G/2
Walls							
43	S-WALL-OTLN	S-WALLOTM-	Wall outline	0, 2	0.35	Y/2	Y/4
45	S-WALL-VBAR	S-WALLVBM-	Vertical/primary reinforcement	0, 2	0.50	C/4	C/7
46	S-WALL-HBAR	S-WALLHBM-	Horizontal/secondary reinforcement	0, 2	0.50	C/4	C/7
49	S-WALL-OPEN	S-WALLOPM-	Openings and penetrations	0, 2	0.25	R/1	R/3
Demolition (used only in creating Existing/Demolition model files)							
56	S-STAT-DEMO-PHS1	S-----M-D---1	Demolition - phase 1	0	0.50	203	45
57	S-STAT-DEMO-PHS2	S-----M-D---2	Demolition - phase 2	0	0.50	83	42
58	S-STAT-DEMO-PHS3	S-----M-D---3	Demolition - phase 3	0	0.50	163	41

Note: V = Varies, NA = Not Applicable

Discipline: Structural
Model File Type: Sections

Level #	Level/Layer Naming		Level/Layer Description	Graphics			
	AIA Format	ISO Format		Line Style	Line Width (mm)	AutoCAD Line Color#	MicroStation Line Color#
General Information							
1	S-ANNO-DIMS	S-----DIP-	Witness/extension lines, dimension terminators, dimension text, welding symbols	0	V	V	V
2	S-ANNO-KEYN	S-----KEP-	Reference keynotes with associated leaders	0	V	V	V
3	S-ANNO-NPLT	S-----NPP-	Non-plotting graphic information	V	0.18	B/5	B/1
4	S-ANNO-PATT	S-----PAP-	Miscellaneous patterning and hatching	0	0.18	Gr/8	Gr/9
5	S-ANNO-NOTE	S-----NOP-	General notes and general remarks	0	0.35	Y/2	Y/4
6	S-ANNO-SYMB	S-----SYP-	Reference bubbles, matchlines and breaklines	V	0.35	M/6	M/5
7	S-ANNO-TEXT	S-----TEP-	Miscellaneous text and callouts with associated leaders	0	V	V	V
NA	S-ANNO-REFR	S-----RFP-	Reference files (AutoCAD users only, see Chapter 4)	NA	NA	NA	NA
Section Information							
9	S-SECT-GENF	S-SECTGEM-	General features (miscellaneous items)	0, 2	0.35	M/6	M/5
10	S-SECT-CMUW	S-SECTCMM-	CMU outline (no patterning)	0, 2	0.35	Y/2	Y/4
11	S-SECT-CNTR	S-SECTCNM-	Centerlines	7	0.18	B/5	B/1
12	S-SECT-PRIM	S-SECTPRM-	Primary beams/girders outlines	0, 2	0.50	C/4	C/7
15	S-SECT-CONC	S-SECTCOM-	Concrete outline (no patterning)	0, 2	0.35	M/6	M/5
20	S-SECT-WOOD	S-SECTWOM-	Wood outline (no patterning)	0, 2	0.35	Y/2	Y/4
33	S-SECT-JOIN	S-SECTJOM-	Joint materials (e.g., felt), vapor barrier, other	0, 2	0.25	R/1	R/3
34	S-SECT-STLS	S-SECTSTM-	Wide flange shapes, plates, open web joists, decking	0, 2	0.25	G/3	G/2
35	S-SECT-MISC	S-SECTMIM-	Miscellaneous fasteners, anchor bolts, supports	0, 2	0.25	G/3	G/2
36	S-SECT-SHPS	S-SECTSHM-	Miscellaneous shapes, plates	0, 2	0.25	G/3	G/2
40	S-SECT-RBAR	S-SECTRBM-	Rebar, welded wire mesh	0, 2, WWFBRC	0.70	W/7	W/0
45	S-SECT-FNGR	S-SECTFNM-	Finished grade	0	0.35	Y/2	Y/4

Note: V = Varies, NA = Not Applicable

Discipline: Structural

Model File Type: Details

Level #	Level/Layer Naming		Level/Layer Description	Graphics			
	AIA Format	ISO Format		Line Style	Line Width (mm)	AutoCAD Line Color#	MicroStation Line Color#
General Information							
1	S-ANNO-DIMS	S-----DIP-	Witness/extension lines, dimension terminators, dimension text, welding symbols	0	V	V	V
2	S-ANNO-KEYN	S-----KEP-	Reference keynotes with associated leaders	0	V	V	V
3	S-ANNO-NPLT	S-----NPP-	Non-plotting graphic information	V	0.18	B/5	B/1
4	S-ANNO-PATT	S-----PAP-	Miscellaneous patterning and hatching	0	0.18	Gr/8	Gr/9
5	S-ANNO-NOTE	S-----NOP-	General notes and general remarks	0	0.35	Y/2	Y/4
6	S-ANNO-SYMB	S-----SYP-	Reference bubbles, matchlines and breaklines	V	0.35	M/6	M/5
7	S-ANNO-TEXT	S-----TEP-	Miscellaneous text and callouts with associated leaders	0	V	V	V
NA	S-ANNO-REFR	S-----RFP-	Reference files (AutoCAD users only, see Chapter 4)	NA	NA	NA	NA
Detail Information							
11	S-DETL-GRPH	S-DETLGRM-	Graphics, gridlines, non-text items	V	V	V	V
12	S-DETL-METR	S-DETLMEM-	Metric-specific dimensions and notes	0	0.35	Y/2	Y/4
13	S-DETL-INPD	S-DETLINM-	Inch-pound-specific dimensions and notes	0	0.35	Y/2	Y/4
Demolition							
56	S-STAT-DEMO-PHS1	S-----M-D----1	Demolition - phase 1	0	0.50	203	45
57	S-STAT-DEMO-PHS2	S-----M-D----2	Demolition - phase 2	0	0.50	83	42
58	S-STAT-DEMO-PHS3	S-----M-D----3	Demolition - phase 3	0	0.50	163	41

Note: V = Varies, NA = Not Applicable

Discipline: Architectural
Model File Type: Floor Plan

Level #	Level/Layer Naming		Level/Layer Description	Graphics			
	AIA Format	ISO Format		Line Style	Line Width (mm)	AutoCAD Line Color/#	MicroStation Line Color/#
General Information							
1	A-ANNO-DIMS	A-----DIP-	Witness/extension lines, dimension terminators, dimension text	0	V	V	V
2	A-ANNO-KEYN	A-----KEP-	Reference keynotes with associated leaders	0	V	V	V
3	A-ANNO-NPLT	A-----NPP-	Non-plotting graphic information	V	0.18	B/5	B/1
4	A-ANNO-PATT	A-----PAP-	Miscellaneous patterning and hatching	0	0.18	Gr/8	Gr/9
5	A-ANNO-NOTE	A-----NOP-	General notes and general remarks	0	0.35	Y/2	Y/4
6	A-ANNO-SYMB	A-----SYP-	Miscellaneous symbols	V	0.35	M/6	M/5
7	A-ANNO-TEXT	A-----TEP-	Miscellaneous text and callouts with associated leaders	0	V	V	V
NA	A-ANNO-REFR	A-----RFP-	Reference files (AutoCAD users only, see Chapter 4)	NA	NA	NA	NA
Floor Information							
8	A-FLOR-IDEN	A-FLORIDM-	Room name, space identification text	0	0.25	G/3	G/2
9	A-FLOR-NUMB	A-FLORNUM-	Room/space identification number and symbol	0	0.25	G/3	G/2
13	A-FLOR-LEVL	A-FLORLEM-	Level changes, shafts, ramps, pits, breaks in construction, and depressions	0	0.35	M/6	M/5
15	A-FLOR-OTLN	A-FLOROTM-	Floor outline/perimeter/building footprint	0	0.35	M/6	M/5
16	A-FLOR-PATT	A-FLORPAM-	Paving, tile, carpet patterns	0	0.18	Gr/8	Gr/9
17	A-FLOR-RAIS	A-FLORRAM-	Access (raised) flooring	0	0.25	G/3	G/2
18	A-FLOR-OTLN-RPRM	A-FLORORM-	Room perimeter shape (Interior walls)	0	0.35	Y/2	Y/4
19	A-FLOR-SIGN	A-FLORSIM-	Signage	0	0.25	R/1	R/3
20	A-FLOR-SPCL	A-FLORSPM-	Architectural specialties (e.g., toilet room accessories, display cases)	0	0.25	G/3	G/2
Columns							
22	A-COLS-ENCL	A-COLSENM-	Column enclosures/fire protection	0	0.50	C/4	C/7
Walls							
23	A-WALL-CAVI	A-WALLCAM-	Cavity wall lines	0	0.25	R/1	R/3
24	A-WALL-CNTR	A-WALLCNM-	Wall centerlines	7	0.18	B/5	B/1
25	A-WALL-CWMG	A-WALLCWM-	Curtain wall mullions and glass	0	0.25	R/1	R/3
26	A-WALL-FULL-EXTR	A-WALLFEM-	Exterior full height walls	0	0.35	Y/2	Y/4
27	A-WALL-FIRE	A-WALLFIM-	Fire wall designators (patterning)	0	0.35	Y/2	Y/4
28	A-WALL-IDEN	A-WALLIDM-	Wall identification/type text or tags	0	0.25	G/3	G/2
29	A-WALL-FULL-INTR	A-WALLFNM-	Interior full height walls	0	0.25	G/3	G/2
30	A-WALL-MOVE	A-WALLMOM-	Moveable walls/partitions	0	0.18	B/5	B/1
31	A-WALL-PATT	A-WALLPAM-	Wall insulation, hatching, and fill	0	0.18	Gr/8	Gr/9
32	A-WALL-PRHT	A-WALLPRM-	Partial height walls (do not appear on Reflected Ceiling Plan)	0	0.25	R/1	R/3
33	A-WALL-SPCL	A-WALLSPM-	Wall-hung/attached specialties (e.g., fixtures, grab bars (incl. handicap), telephone booths)	0	0.25	R/1	R/3
Openings							
34	A-GLAZ-SILL	A-GLAZSIM-	Window sills	0	0.18	B/5	B/1
35	A-WALL-HEAD	A-WALLHEM-	Door and window headers	0	0.25	R/1	R/3
36	A-WALL-JAMB	A-WALLJAM-	Door and window jambs	0	0.25	R/1	R/3
Doors							
37	A-DOOR-FULL	A-DOORFUM-	Full height (to ceiling) door: swing and leaf	0	0.25	G/3	G/2
38	A-DOOR-IDEN	A-DOORIDM-	Door number and symbol, hardware group, etc.	0	0.25	G/3	G/2
39	A-DOOR-PRHT	A-DOORPRM-	Partial height door: swing and leaf	0	0.35	M/6	M/5
40	A-DOOR-SYMB	A-DOORSYM-	Miscellaneous door symbols (e.g., overhead, bifold, pocket, etc.)	0	0.25	R/1	R/3
Windows							
41	A-GLAZ-FULL	A-GLAZFUM-	Full height glazed walls and partitions (see A-WALL-CWMG for curtain walls)	0	0.25	R/1	R/3
42	A-GLAZ-IDEN	A-GLAZIDM-	Window number and symbol	0	0.25	G/3	G/2
43	A-GLAZ-PRHT	A-GLAZPRM-	Windows and partial height glazed partitions	0	0.25	R/1	R/3
Plumbing Fixtures							
44	A-FLOR-FIXT	A-FLORFXM-	Plumbing fixtures	0	0.25	201	29
45	A-FLOR-TPTN	A-FLORTPM-	Toilet partitions	0	0.25	R/1	R/3
Elevators							
46	A-FLOR-EVTR	A-FLOREVM-	Elevator cars and equipment	0	0.35	Y/2	Y/4
Stairs							
47	A-FLOR-STRS	A-FLORSTM-	Stair risers/treads, escalators, ladders	0	0.35	Y/2	Y/4
Railings							
48	A-FLOR-HRAL	A-FLORHRM-	Stair and balcony handrails, guard rails	0	0.25	R/1	R/3

Discipline: Architectural
Model File Type: Floor Plan

Woodwork							
49	A-FLOR-CASE	A-FLORCAM-	Casework (manufactured cabinets)	0	0.25	G/3	G/2
50	A-FLOR-WDWK	A-FLORWDM-	Architectural woodwork (field built cabinets and counters)	0	0.25	G/3	G/2
Ceiling Penetrations							
51	A-FLOR-OVHD	A-FLOROVM-	Overhead items (skylights, overhangs etc.)	2	0.18	Gr/8	Gr/9
Demolition (used only in creating Existing/Demolition model files)							
56	A-STAT-DEMO-PHS1	A-----M-D----1	Demolition - phase 1	0	0.50	203	45
57	A-STAT-DEMO-PHS2	A-----M-D----2	Demolition - phase 2	0	0.50	83	42
58	A-STAT-DEMO-PHS3	A-----M-D----3	Demolition - phase 3	0	0.50	163	41

Note: V = Varies, NA = Not Applicable

Discipline: Architectural

Model File Type: Reflected Ceiling Plan

Level #	Level/Layer Naming		Level/Layer Description	Graphics			
	AIA Format	ISO Format		Line Style	Line Width (mm)	AutoCAD Line Color/#	MicroStation Line Color/#
General Information							
1	A-ANNO-DIMS	A-----DIP-	Witness/extension lines, dimension terminators, dimension text	0	V	V	V
2	A-ANNO-KEYN	A-----KEP-	Reference keynotes with associated leaders	0	V	V	V
3	A-ANNO-NPLT	A-----NPP-	Non-plotting graphic information	V	0.18	B/5	B/1
4	A-ANNO-PATT	A-----PAP-	Miscellaneous patterning and hatching	0	0.18	Gr/8	Gr/9
5	A-ANNO-NOTE	A-----NOP-	General notes and general remarks	0	0.35	Y/2	Y/4
6	A-ANNO-SYMB	A-----SYP-	Miscellaneous symbols	V	0.35	M/6	M/5
7	A-ANNO-TEXT	A-----TEP-	Miscellaneous text and callouts with associated leaders	0	V	V	V
NA	A-ANNO-REFR	A-----RFP-	Reference files (AutoCAD users only, see Chapter 4)	NA	NA	NA	NA
Ceiling Information							
10	A-CLNG-ACCS	A-CLNGACM-	Access panels	0	0.35	M/6	M/5
12	A-CLNG-CTLJ	A-CLNGCJM-	Ceiling control joints	0	0.35	Y/2	Y/4
13	A-CLNG-GRID	A-CLNGGGM-	Ceiling grid	0	0.25	R/1	R/3
14	A-CLNG-OPEN	A-CLNGOPM-	Openings, ceiling/roof penetrations (see also A-FLOR-OVHD in Model File Type: Floor Plan)	0	0.18	Gr/8	Gr/9
15	A-CLNG-PATT	A-CLNGPAM-	Ceiling patterns	0	0.18	Gr/8	Gr/9
16	A-CLNG-TEES	A-CLNGTEM-	Main tees	0	0.18	B/5	B/1
17	A-CLNG-SUSP	A-CLNGSUM-	Suspended elements, ceiling mounted specialties (e.g., clocks, fans, etc.)	0	0.18	B/5	B/1
Lights							
21	A-LITE-CLNG	A-LITECLM-	Specialty ceiling lights not shown on Electrical Lighting Pla	0	0.50	C/4	C/7
Demolition (used only in creating Existing/Demolition model files)							
56	A-STAT-DEMO-PHS1	A-----M-D----1	Demolition - phase 1	0	0.50	203	45
57	A-STAT-DEMO-PHS2	A-----M-D----2	Demolition - phase 2	0	0.50	83	42
58	A-STAT-DEMO-PHS3	A-----M-D----3	Demolition - phase 3	0	0.50	163	41

Note: V = Varies, NA = Not Applicable

Discipline: Architectural
Model File Type: Roof Plan

Level #	Level/Layer Naming		Level/Layer Description	Graphics			
	AIA Format	ISO Format		Line Style	Line Width (mm)	AutoCAD Line Color/#	MicroStation Line Color/#
General Information							
1	A-ANNO-DIMS	A-----DIP-	Witness/extension lines, dimension terminators, dimension text	0	V	V	V
2	A-ANNO-KEYN	A-----KEP-	Reference keynotes with associated leaders	0	V	V	V
3	A-ANNO-NPLT	A-----NPP-	Non-plotting graphic information	V	0.18	B/5	B/1
4	A-ANNO-PATT	A-----PAP-	Miscellaneous patterning and hatching (see also A-ROOF-PATT)	0	0.18	Gr/8	Gr/9
5	A-ANNO-NOTE	A-----NOP-	General notes and general remarks	0	0.35	Y/2	Y/4
6	A-ANNO-SYMB	A-----SYP-	Miscellaneous symbols	V	0.35	M/6	M/5
7	A-ANNO-TEXT	A-----TEP-	Miscellaneous text and callouts with associated leaders	0	V	V	V
NA	A-ANNO-REFR	A-----RFP-	Reference files (AutoCAD users only, see Chapter 4)	NA	NA	NA	NA
Roof Information							
11	A-ROOF-CRTS	A-ROOFCRM-	Crickets flow arrows flow info	0	0.25	R/1	R/3
12	A-ROOF-RFDR	A-ROOFRDM-	Roof drains	0	0.25	R/1	R/3
13	A-ROOF-GUTR	A-ROOFGUM-	Roof internal gutters	0	0.18	Gr/8	Gr/9
14	A-ROOF-EXPJ	A-ROOFEXM-	Expansion joints	0	0.18	B/5	B/1
15	A-ROOF-HRAL	A-ROOFHRM-	Stair handrails, nosings, guard rails	0	0.18	B/5	B/1
16	A-ROOF-LEVL	A-ROOFFLEM-	Level changes	0	0.18	B/5	B/1
17	A-ROOF-OTLN	A-ROOFOTM-	Roof perimeter/edge, roof geometry	0	0.35	M/6	M/5
18	A-ROOF-PATT	A-ROOFPAM-	Roof surface patterns, hatching	0	0.18	Gr/8	Gr/9
19	A-ROOF-SPCL	A-ROOFSPM-	Roof specialties, accessories, access hatches, dormers	0	0.25	G/3	G/2
20	A-ROOF-STRS	A-ROOFSTM-	Stair risers/treads, ladders	0	0.18	B/5	B/1
21	A-ROOF-WALK	A-ROOFWAM-	Roof walkways	0	0.25	G/3	G/2
22	A-ROOF-WALL	A-ROOFWLM-	Parapet walls and wall caps	0	0.35	Y/2	Y/4
Demolition (used only in creating Existing/Demolition model files)							
56	A-STAT-DEMO-PHS1	A-----M-D-----1	Demolition - phase 1	0	0.50	203	45
57	A-STAT-DEMO-PHS2	A-----M-D-----2	Demolition - phase 2	0	0.50	83	42
58	A-STAT-DEMO-PHS3	A-----M-D-----3	Demolition - phase 3	0	0.50	163	41

Note: V = Varies, NA = Not Applicable

Discipline: Architectural
Model File Type: Equipment Plan

Level #	Level/Layer Naming		Level/Layer Description	Graphics			
	AIA Format	ISO Format		Line Style	Line Width (mm)	AutoCAD Line Color/#	MicroStation Line Color/#
General Information							
1	A-ANNO-DIMS	A-----DIP-	Witness/extension lines, dimension terminators, dimension text	0	V	V	V
2	A-ANNO-KEYN	A-----KEP-	Reference keynotes with associated leaders	0	V	V	V
3	A-ANNO-NPLT	A-----NPP-	Non-plotting graphic information	V	0.18	B/5	B/1
4	A-ANNO-PATT	A-----PAP-	Miscellaneous patterning and hatching	0	0.18	Gr/8	Gr/9
5	A-ANNO-NOTE	A-----NOP-	General notes and general remarks	0	0.35	Y/2	Y/4
6	A-ANNO-SYMB	A-----SYP-	Miscellaneous symbols	V	0.35	M/6	M/5
7	A-ANNO-TEXT	A-----TEP-	Miscellaneous text and callouts with associated leaders	0	V	V	V
NA	A-ANNO-REFR	A-----RFP-	Reference files (AutoCAD users only, see Chapter 4)	NA	NA	NA	NA
Equipment							
11	A-EQPM-ACCS	A-EQPMACM-	Equipment access	0	0.35	M/6	M/5
12	A-EQPM-OVHD	A-EQPMOVM-	Overhead, ceiling mounted, or suspended equipment	0	0.35	M/6	M/5
13	A-EQPM-FIXD	A-EQPMFIM-	Fixed equipment	0	0.50	C/4	C/7
14	A-EQPM-IDEN	A-EQPMIDM-	Equipment identification numbers	0	0.35	M/6	M/5
15	A-EQPM-MOVE	A-EQPMOMM-	Moveable equipment	0	0.35	M/6	M/5
16	A-EQPM-NICN	A-EQPMNCM-	Not in contract equipment	3	0.35	M/6	M/5
Demolition (used only in creating Existing/Demolition model files)							
56	A-STAT-DEMO-PHS1	A-----M-D----1	Demolition - phase 1	0	0.50	203	45
57	A-STAT-DEMO-PHS2	A-----M-D----2	Demolition - phase 2	0	0.50	83	42
58	A-STAT-DEMO-PHS3	A-----M-D----3	Demolition - phase 3	0	0.50	163	41

Note: V = Varies, NA = Not Applicable

Discipline: Architectural

Model File Type: Area Calculations/Occupancy Plan

Level #	Level/Layer Naming		Level/Layer Description	Graphics			
	AIA Format	ISO Format		Line Style	Line Width (mm)	AutoCAD Line Color#	MicroStation Line Color#
General Information							
1	A-ANNO-DIMS	A-----DIP-	Witness/extension lines, dimension terminators, dimension text	0	V	V	V
2	A-ANNO-KEYN	A-----KEP-	Reference keynotes with associated leaders	0	V	V	V
3	A-ANNO-NPLT	A-----NPP-	Non-plotting graphic information	V	0.18	B/5	B/1
4	A-ANNO-PATT	A-----PAP-	Miscellaneous patterning and hatching	0	0.18	Gr/8	Gr/9
5	A-ANNO-NOTE	A-----NOP-	General notes and general remarks	0	0.35	Y/2	Y/4
6	A-ANNO-SYMB	A-----SYP-	Miscellaneous symbols	V	0.35	M/6	M/5
7	A-ANNO-TEXT	A-----TEP-	Miscellaneous text and callouts with associated leaders	0	V	V	V
NA	A-ANNO-REFR	A-----RFP-	Reference files (AutoCAD users only, see Chapter 4)	NA	NA	NA	NA
Area Information							
9	A-AREA-IDEN	A-AREAIDM-	Room numbers, tenant identifications, area calculations	0	0.35	Y/2	Y/4
10	A-AREA-LINE	A-AREALIM-	Architectural area calculation boundary lines	0	0.50	C/4	C/7
11	A-AREA-OCCP	A-AREAOCM-	Occupant or employee names	0	0.35	Y/2	Y/4
12	A-AREA-PATT	A-AREAPAM-	Area cross hatching	0	0.18	Gr/8	Gr/9

Note: V = Varies, NA = Not Applicable

Discipline: Architectural

Model File Type: Elevations (Exterior and Interior)

Level #	Level/Layer Naming		Level/Layer Description	Graphics			
	AIA Format	ISO Format		Line Style	Line Width (mm)	AutoCAD Line Color#	MicroStation Line Color#
General Information							
1	A-ANNO-DIMS	A-----DIP-	Witness/extension lines, dimension terminators, dimension text	0	V	V	V
2	A-ANNO-KEYN	A-----KEP-	Reference keynotes with associated leaders	0	V	V	V
3	A-ANNO-NPLT	A-----NPP-	Non-plotting graphic information	V	0.18	B/5	B/1
4	A-ANNO-PATT	A-----PAP-	Miscellaneous patterning and hatching	0	0.18	Gr/8	Gr/9
5	A-ANNO-NOTE	A-----NOP-	General notes and general remarks	0	0.35	Y/2	Y/4
6	A-ANNO-SYMB	A-----SYP-	Miscellaneous symbols	V	0.35	M/6	M/5
7	A-ANNO-TEXT	A-----TEP-	Miscellaneous text and callouts with associated leaders	0	V	V	V
NA	A-ANNO-REFR	A-----RFP-	Reference files (AutoCAD users only, see Chapter 4)	NA	NA	NA	NA
Elevations							
37	A-ELEV-CASE	A-ELEV CAM-	Wall-mounted casework	0	0.25	G/3	G/2
38	A-ELEV-FIXT	A-ELEV FIM-	Miscellaneous fixtures	0	0.35	Y/2	Y/4
39	A-ELEV-FNSH	A-ELEV FNM-	Finishes, woodwork, trim	0	0.25	G/3	G/2
40	A-ELEV-IDEN	A-ELEV IDM-	Component identification numbers	0	0.35	Y/2	Y/4
41	A-ELEV-OTLN	A-ELEV OTM-	Building outlines	0	0.35	M/6	M/5
42	A-ELEV-PATT	A-ELEV PAM-	Textures and hatch patterns	0	0.18	Gr/8	Gr/9
43	A-ELEV-PFIX	A-ELEV PFM-	Plumbing fixtures	0	0.35	M/6	M/5
44	A-ELEV-SIGN	A-ELEV SIM-	Signage	0	0.25	R/1	R/3
Demolition (used only in creating Existing/Demolition model files)							
56	A-STAT-DEMO-PHS1	A-----M-D----1	Demolition - phase 1	0	0.50	203	45
57	A-STAT-DEMO-PHS2	A-----M-D----2	Demolition - phase 2	0	0.50	83	42
58	A-STAT-DEMO-PHS3	A-----M-D----3	Demolition - phase 3	0	0.50	163	41

Note: V = Varies, NA = Not Applicable

Discipline: Architectural
Model File Type: Sections

Level #	Level/Layer Naming		Level/Layer Description	Graphics			
	AIA Format	ISO Format		Line Style	Line Width (mm)	AutoCAD Line Color/#	MicroStation Line Color/#
General Information							
1	A-ANNO-DIMS	A-----DIP-	Witness/extension lines, dimension terminators, dimension text	0	V	V	V
2	A-ANNO-KEYN	A-----KEP-	Reference keynotes with associated leaders	0	V	V	V
3	A-ANNO-NPLT	A-----NPP-	Non-plotting graphic information	V	0.18	B/5	B/1
4	A-ANNO-PATT	A-----PAP-	Miscellaneous patterning and hatching	0	0.18	Gr/8	Gr/9
5	A-ANNO-NOTE	A-----NOP-	General notes and general remarks	0	0.35	Y/2	Y/4
6	A-ANNO-SYMB	A-----SYP-	Miscellaneous symbols	V	0.35	M/6	M/5
7	A-ANNO-TEXT	A-----TEP-	Miscellaneous text and callouts with associated leaders	0	V	V	V
NA	A-ANNO-REFR	A-----RFP-	Reference files (AutoCAD users only, see Chapter 4)	NA	NA	NA	NA
Sections							
45	A-SECT-IDEN	A-SECTIDM-	Component identification numbers	0	0.35	Y/2	Y/4
46	A-SECT-MBND	A-SECTMBM-	Material beyond section cut	0	0.18	B/5	B/1
47	A-SECT-MCUT	A-SECTMCM-	Material cut by section	V	V	V	V
48	A-SECT-PATT	A-SECTPAM-	Textures and hatch patterns	0	0.18	Gr/8	Gr/9
Demolition (used only in creating Existing/Demolition model files)							
56	A-STAT-DEMO-PHS1	A-----M-D----1	Demolition - phase 1	0	0.50	203	45
57	A-STAT-DEMO-PHS2	A-----M-D----2	Demolition - phase 2	0	0.50	83	42
58	A-STAT-DEMO-PHS3	A-----M-D----3	Demolition - phase 3	0	0.50	163	41

Note: V = Varies, NA = Not Applicable

Discipline: Architectural

Model File Type: Details

Level #	Level/Layer Naming		Level/Layer Description	Graphics			
	AIA Format	ISO Format		Line Style	Line Width (mm)	AutoCAD Line Color/#	MicroStation Line Color/#
General Information							
1	A-ANNO-DIMS	A-----DIP-	Witness/extension lines, dimension terminators, dimension text	0	V	V	V
2	A-ANNO-KEYN	A-----KEP-	Reference keynotes with associated leaders	0	V	V	V
3	A-ANNO-NPLT	A-----NPP-	Non-plotting graphic information	V	0.18	B/5	B/1
4	A-ANNO-PATT	A-----PAP-	Miscellaneous patterning	0	0.18	Gr/8	Gr/9
5	A-ANNO-NOTE	A-----NOP-	General notes and general remarks	0	0.35	Y/2	Y/4
6	A-ANNO-SYMB	A-----SYP-	Reference bubbles, matchlines and breaklines	V	0.35	M/6	M/5
7	A-ANNO-TEXT	A-----TEP-	Detail title text, text and associated leaders, notes	V	V	V	V
Detail Information							
11	A-DETL-GRPH	A-DETLGRM-	Graphics, gridlines, non-text items	V	V	V	V
12	A-DETL-METR	A-DETLMEM-	Metric-specific dimensions and notes	0	0.35	Y/2	Y/4
13	A-DETL-INPD	A-DETLINM-	Inch-pound-specific dimensions and notes	0	0.35	Y/2	Y/4
Demolition							
56	A-STAT-DEMO-PHS1	A-----M-D----1	Demolition - phase 1	0	0.50	203	45
57	A-STAT-DEMO-PHS2	A-----M-D----2	Demolition - phase 2	0	0.50	83	42
58	A-STAT-DEMO-PHS3	A-----M-D----3	Demolition - phase 3	0	0.50	163	41

Note: V = Varies, NA = Not Applicable

Discipline: Interiors

Model File Type: Furniture Plan

Level #	Level/Layer Naming		Level/Layer Description	Graphics			
	AIA Format	ISO Format		Line Style	Line Width (mm)	AutoCAD Line Color/#	MicroStation Line Color/#
General Information							
1	I-ANNO-DIMS	I-----DIP-	Witness/extension lines, dimension terminators, dimension text	0	V	V	V
2	I-ANNO-KEYN	I-----KEP-	Reference keynotes with associated leaders	0	V	V	V
3	I-ANNO-NPLT	I-----NPP-	Non-plotting graphic information	V	0.18	B/5	B/1
4	I-ANNO-PATT	I-----PAP-	Miscellaneous patterning and hatching	0	0.18	Gr/8	Gr/9
5	I-ANNO-NOTE	I-----NOP-	General notes and general remarks	0	0.35	Y/2	Y/4
6	I-ANNO-SYMB	I-----SYP-	Miscellaneous symbols	V	0.35	M/6	M/5
7	I-ANNO-TEXT	I-----TEP-	Miscellaneous text and callouts with associated leaders	0	V	V	V
NA	I-ANNO-REFR	I-----RFP-	Reference files (AutoCAD users only, see Chapter 4)	NA	NA	NA	NA
Equipment							
11	I-EQPM-ACCS	I-EQPMACM-	Equipment access	2	0.18	Gr/8	Gr/9
12	I-EQPM-CHLD	I-EQPMCHM-	Child development (play toys, teaching rugs, play forms)	0	0.35	Y/2	Y/4
13	I-EQPM-OVHD	I-EQPMOVM-	Overhead, ceiling mounted, and suspended equipment	0	0.25	G/3	G/2
14	I-EQPM-COPY	I-EQPMCOM-	Copiers, fax machines, office equipment	0	0.35	Y/2	Y/4
15	I-EQPM-FIXD	I-EQPMFIM-	Fixed equipment	0	0.18	B/5	B/1
16	I-EQPM-IDEN	I-EQPMIDM-	Equipment identification numbers	0	0.25	R/1	R/3
17	I-EQPM-MOVE	I-EQPMMOV-	Moveable equipment	2	0.18	B/5	B/1
18	I-EQPM-NICN	I-EQPMNIM-	Not in contract equipment	1	0.18	Gr/8	Gr/9
19	I-EQPM-STOR	I-EQPMSTM-	Storage equipment	0	0.35	Y/2	Y/4
20	I-EQPM-MEDI	I-FURNMEM-	Medical (exam beds, dental chairs, etc.)	0	0.35	Y/2	Y/4
Furnishings							
25	I-FURN-ACCS	I-FURNACM-	Accessories (vestibule mats, partitions, draperies, clocks, trash cans, lecturns lamps, etc.)	0	0.25	R/1	R/3
26	I-FURN-ADPC	I-FURNADM-	Automated Data Processing Components	0	0.35	Y/2	Y/4
27	I-FURN-ARTW	I-FURNARM-	Artwork	0	0.35	Y/2	Y/4
29	I-FURN-FLOR	I-FURNFLM-	Flooring (carpet, rugs, etc.)	0	0.35	Y/2	Y/4
30	I-FURN-FREE	I-FURNFRM-	Free-standing furnishings (desks, beds, tables, dressers, credenzas, casegoods)	0	0.35	M/6	M/5
31	I-FURN-IDEN	I-FURNIDM-	Furniture code identification	0	0.25	G/3	G/2
34	I-FURN-PLNT	I-FURNPLM-	Plants	0	0.25	R/1	R/3
35	I-FURN-SEAT	I-FURNSEM-	Chairs, sofas, etc.	0	0.35	Y/2	Y/4
36	I-FURN-STOR	I-FURNSTM-	File cabinets, high density storage, shelving, storage cabinets	0	0.35	Y/2	Y/4
Modules							
40	I-FURN-GRID	I-FURNGRM-	Planning grid/modular outline	0	0.50	C/4	C/7
Demolition (used only in creating Existing/Demolition model files)							
56	I-STAT-DEMO-PHS1	I-----M-D----1	Demolition - phase 1	0	0.50	203	45
57	I-STAT-DEMO-PHS2	I-----M-D----2	Demolition - phase 2	0	0.50	83	42
58	I-STAT-DEMO-PHS3	I-----M-D----3	Demolition - phase 3	0	0.50	163	41

Note: V = Varies, NA = Not Applicable

Discipline: Interiors

Model File Type: System Furniture Plan/Workstation Typical

Level #	Level/Layer Naming		Level/Layer Description	Graphics			
	AIA Format	ISO Format		Line Style	Line Width (mm)	AutoCAD Line Color/#	MicroStation Line Color/#
General Information							
1	I-ANNO-DIMS	I-----DIP-	Witness/extension lines, dimension terminators, dimension text	0	V	V	V
2	I-ANNO-KEYN	I-----KEP-	Reference keynotes with associated leaders	0	V	V	V
3	I-ANNO-NPLT	I-----NPP-	Non-plotting graphic information	V	0.18	B/5	B/1
4	I-ANNO-PATT	I-----PAP-	Miscellaneous patterning and hatching	0	0.18	Gr/8	Gr/9
5	I-ANNO-NOTE	I-----NOP-	General notes and general remarks	0	0.35	Y/2	Y/4
6	I-ANNO-SYMB	I-----SYP-	Miscellaneous symbols	V	0.35	M/6	M/5
7	I-ANNO-TEXT	I-----TEP-	Miscellaneous text and callouts with associated leaders	0	V	V	V
NA	I-ANNO-REFR	I-----RFP-	Reference files (AutoCAD users only, see Chapter 4)	NA	NA	NA	NA
Systems Furniture							
11	I-SYST-FURN	I-SYSTFUM-	Furniture	0	0.35	Y/2	Y/4
12	I-SYST-IDEN	I-SYSTIDM-	Code identification	0	0.25	R/1	R/3
13	I-SYST-LITE	I-SYSTLIM-	Lighting components	0	0.50	C/4	C/7
14	I-SYST-PATT	I-SYSTPAM-	Patterns	0	0.18	Gr/8	Gr/9
15	I-SYST-PNLS	I-SYSTPNM-	Panels	0	0.35	Y/2	Y/4
16	I-SYST-POWR	I-SYSTPOM-	Power, communication components	0	0.50	C/4	C/7
17	I-SYST-STOR	I-SYSTSTM-	Storage components	0	0.35	Y/2	Y/4
18	I-SYST-WALL	I-SYSTWAM-	Systems furniture partition walls	0	0.35	Y/2	Y/4
19	I-SYST-WKSF	I-SYSTWKM-	Work surface components	0	0.35	Y/2	Y/4
Demolition (used only in creating Existing/Demolition model files)							
56	I-STAT-DEMO-PHS1	I-----M-D----1	Demolition - phase 1	0	0.50	203	45
57	I-STAT-DEMO-PHS2	I-----M-D----2	Demolition - phase 2	0	0.50	83	42
58	I-STAT-DEMO-PHS3	I-----M-D----3	Demolition - phase 3	0	0.50	163	41

Note: V = Varies, NA = Not Applicable

Discipline: Interiors

Model File Type: Signage Placement Plan

Level #	Level/Layer Naming		Level/Layer Description	Graphics			
	AIA Format	ISO Format		Line Style	Line Width (mm)	AutoCAD Line Color#	MicroStation Line Color#
General Information							
1	I-ANNO-DIMS	I-----DIP-	Witness/extension lines, dimension terminators, dimension text	0	V	V	V
2	I-ANNO-KEYN	I-----KEP-	Reference keynotes with associated leaders	0	V	V	V
3	I-ANNO-NPLT	I-----NPP-	Non-plotting graphic information	V	0.18	B/5	B/1
4	I-ANNO-PATT	I-----PAP-	Miscellaneous patterning and hatching	0	0.18	Gr/8	Gr/9
5	I-ANNO-NOTE	I-----NOP-	General notes and general remarks	0	0.35	Y/2	Y/4
6	I-ANNO-SYMB	I-----SYP-	Miscellaneous symbols	V	0.35	M/6	M/5
7	I-ANNO-TEXT	I-----TEP-	Miscellaneous text and callouts with associated leaders	0	V	V	V
NA	I-ANNO-REFR	I-----RFP-	Reference files (AutoCAD users only, see Chapter 4)	NA	NA	NA	NA
Signage							
46	I-FLOR-SIGN	I-FLORSIM-	Signage	0	0.35	M/6	M/5
Demolition (used only in creating Existing/Demolition model files)							
56	I-STAT-DEMO-PHS1	I-----M-D----1	Demolition - phase 1	0	0.50	203	45
57	I-STAT-DEMO-PHS2	I-----M-D----2	Demolition - phase 2	0	0.50	83	42
58	I-STAT-DEMO-PHS3	I-----M-D----3	Demolition - phase 3	0	0.50	163	41

Note: V = Varies, NA = Not Applicable

Discipline: Interiors

Model File Type: Elevations

Level #	Level/Layer Naming		Level/Layer Description	Graphics			
	AIA Format	ISO Format		Line Style	Line Width (mm)	AutoCAD Line Color/#	MicroStation Line Color/#
General Information							
1	I-ANNO-DIMS	I-----DIP-	Witness/extension lines, dimension terminators, dimension text	0	V	V	V
2	I-ANNO-KEYN	I-----KEP-	Reference keynotes with associated leaders	0	V	V	V
3	I-ANNO-NPLT	I-----NPP-	Non-plotting graphic information	V	0.18	B/5	B/1
4	I-ANNO-PATT	I-----PAP-	Miscellaneous patterning and hatching	0	0.18	Gr/8	Gr/9
5	I-ANNO-NOTE	I-----NOP-	General notes and general remarks	0	0.35	Y/2	Y/4
6	I-ANNO-SYMB	I-----SYP-	Miscellaneous symbols	V	0.35	M/6	M/5
7	I-ANNO-TEXT	I-----TEP-	Miscellaneous text and callouts with associated leaders	0	V	V	V
NA	I-ANNO-REFR	I-----RFP-	Reference files (AutoCAD users only, see Chapter 4)	NA	NA	NA	NA
Elevations							
37	I-ELEV-CASE	I-ELEV-CAM-	Wall mounted casework	0	0.35	Y/2	Y/4
38	I-ELEV-FIXT	I-ELEV-FIM-	Miscellaneous fixtures	0	0.25	G/3	G/2
39	I-ELEV-FNSH	I-ELEV-FNM-	Finishes, woodwork and trim	0	0.35	Y/2	Y/4
40	I-ELEV-IDEN	I-ELEV-IDM-	Component identification numbers	0	0.18	B/5	B/1
42	I-ELEV-PATT	I-ELEV-PAM-	Textures and hatch patterns	0	0.25	R/1	R/3
43	I-ELEV-PFIX	I-ELEV-PFM-	Plumbing fixtures in elevation	0	0.25	R/1	R/3
44	I-ELEV-SIGN	I-ELEV-SIM-	Signage	0	0.25	R/1	R/3
Demolition (used only in creating Existing/Demolition model files)							
56	I-STAT-DEMO-PHS1	I-----M-D----1	Demolition - phase 1	0	0.50	203	45
57	I-STAT-DEMO-PHS2	I-----M-D----2	Demolition - phase 2	0	0.50	83	42
58	I-STAT-DEMO-PHS3	I-----M-D----3	Demolition - phase 3	0	0.50	163	41

Note: V = Varies, NA = Not Applicable

Discipline: Interiors

Model File Type: Details

Level #	Level/Layer Naming		Level/Layer Description	Graphics			
	AIA Format	ISO Format		Line Style	Line Width (mm)	AutoCAD Line Color/#	MicroStation Line Color/#
General Information							
1	I-ANNO-DIMS	I-----DIP-	Witness/extension lines, dimension terminators, dimension text	0	V	V	V
2	I-ANNO-KEYN	I-----KEP-	Reference keynotes with associated leaders	0	V	V	V
3	I-ANNO-NPLT	I-----NPP-	Non-plotting graphic information	V	0.18	B/5	B/1
4	I-ANNO-PATT	I-----PAP-	Miscellaneous patterning	0	0.18	Gr/8	Gr/9
5	I-ANNO-NOTE	I-----NOP-	General notes and general remarks	0	0.35	Y/2	Y/4
6	I-ANNO-SYMB	I-----SYP-	Reference bubbles, matchlines and breaklines	V	0.35	M/6	M/5
7	I-ANNO-TEXT	I-----TEP-	Detail title text, text and associated leaders, notes	0	V	V	V
Detail Information							
11	I-DETL-GRPH	I-DETLGRM-	Graphics, gridlines, non-text items	V	V	V	V
12	I-DETL-METR	I-DETLMEM-	Metric-specific dimensions and notes	0	0.35	Y/2	Y/4
13	I-DETL-INPD	I-DETLINM-	Inch-pound-specific dimensions and notes	0	0.35	Y/2	Y/4
Demolition							
56	I-STAT-DEMO-PHS1	I-----M-D----1	Demolition - phase 1	0	0.50	203	45
57	I-STAT-DEMO-PHS2	I-----M-D----2	Demolition - phase 2	0	0.50	83	42
58	I-STAT-DEMO-PHS3	I-----M-D----3	Demolition - phase 3	0	0.50	163	41

Note: V = Varies, NA = Not Applicable

Discipline: Fire Protection
Model File Type: Life Safety Plan

Level #	Level/Layer Naming		Level/Layer Description	Graphics			
	AIA Format	ISO Format		Line Style	Line Width (mm)	AutoCAD Line Color/#	MicroStation Line Color/#
General Information							
1	F-ANNO-DIMS	F-----DIP-	Witness/extension lines, dimension terminators, dimension text	0	V	V	V
2	F-ANNO-KEYN	F-----KEP-	Reference keynotes with associated leaders	0	V	V	V
3	F-ANNO-NPLT	F-----NPP-	Non-plotting graphic information	V	0.18	B/5	B/1
4	F-ANNO-PATT	F-----PAP-	Miscellaneous patterning and hatching	0	0.18	Gr/8	Gr/9
5	F-ANNO-NOTE	F-----NOP-	General notes and general remarks	0	0.35	Y/2	Y/4
6	F-ANNO-SYMB	F-----SYP-	Miscellaneous symbols	V	0.35	M/6	M/5
7	F-ANNO-TEXT	F-----TEP-	Miscellaneous text and callouts with associated leaders	0	V	V	V
NA	F-ANNO-REFR	F-----RFP-	Reference files (AutoCAD users only, see Chapter 4)	NA	NA	NA	NA
Floor Information							
8	F-FLOR-IDEN	F-FLORIDM-	Room name, space identification text (copied from Architectural - Floor Plan model file)	0	0.25	G/3	G/2
9	F-FLOR-NUMB	F-FLORNUM-	Room/space identification number and symbol (copied from Architectural - Floor Plan model file)	0	0.25	G/3	G/2
Fire Protection/Suppression Equipment							
11	F-PROT-CABN	F-PROTCAM-	Fire hose cabinets	0	0.35	Y/2	Y/4
12	F-PROT-EXTN	F-PROTEXM-	Fire extinguishers and fire extinguisher cabinets	0	0.35	Y/2	Y/4
13	F-PROT-HOSE	F-PROTHOM-	Fire hoses	0	0.35	Y/2	Y/4
Fire Ratings							
14	F-RATE-WALL	F-RATEWAM-	Wall fire ratings	0	0.50	C/4	C/7
15	F-RATE-DOOR	F-RATEDOM-	Door fire ratings	0	0.50	C/4	C/7
Means of Egress Lighting							
19	F-LITE-EMER	F-LITEEMM-	Emergency fixtures	0	0.50	23	46
20	F-LITE-EXIT	F-LITEEXM-	Exit fixtures	0	0.50	203	45
Egress Requirements							
22	F-LSFT-EGRE	F-LSFTEGM-	Egress requirements designator	0	0.35	M/6	M/5
23	F-LSFT-TRVL	F-LSFTTRM-	Maximum travel distances	0	0.35	M/6	M/5
24	F-LSFT-OCCP	F-LSFTOCM-	Occupant load for egress capacity	0	0.35	M/6	M/5
Control Panels							
26	F-CTRL-PANL	F-CTRLPAM-	Control panels	0	0.50	23	46
Fire Alarm/Detection Equipment							
31	F-ALRM-MANL	F-ALRMMAM-	Manual fire alarm pull stations	0	0.50	23	46
Smoke/Pressurization Control							
38	F-SMOK-DAMP	F-SMOKDAM-	Dampers	0	0.35	22	22
Demolition (used only in creating Existing/Demolition model files)							
56	F-STAT-DEMO-PHS1	F-----M-D----1	Demolition - phase 1	0	0.50	203	45
57	F-STAT-DEMO-PHS2	F-----M-D----2	Demolition - phase 2	0	0.50	83	42
58	F-STAT-DEMO-PHS3	F-----M-D----3	Demolition - phase 3	0	0.50	163	41

Note: V = Varies, NA = Not Applicable

Discipline: Fire Protection
Model File Type: Fire Suppression Plan

Level #	Level/Layer Naming		Level/Layer Description	Graphics			
	AIA Format	ISO Format		Line Style	Line Width (mm)	AutoCAD Line Color#	MicroStation Line Color#
General Information							
1	F-ANNO-DIMS	F-----DIP-	Witness/extension lines, dimension terminators, dimension text	0	V	V	V
2	F-ANNO-KEYN	F-----KEP	Reference keynotes with associated leaders	0	V	V	V
3	F-ANNO-NPLT	F-----NPP-	Non-plotting graphic information	V	0.18	B/5	B/1
4	F-ANNO-PATT	F-----PAP-	Miscellaneous patterning and hatching	0	0.18	Gr/8	Gr/9
5	F-ANNO-NOTE	F-----NOP-	General notes and general remarks	0	0.35	Y/2	Y/4
6	F-ANNO-SYMB	F-----SYP-	Miscellaneous symbols	V	0.35	M/6	M/5
7	F-ANNO-TEXT	F-----TEP-	Miscellaneous text and callouts with associated leaders	0	V	V	V
NA	F-ANNO-REFR	F-----RFP-	Reference files (AutoCAD users only, see Chapter 4)	NA	NA	NA	NA
Floor Information							
8	F-FLOR-IDEN	F-FLORIDM-	Room name, space identification text (copied from Architectural - Floor Plan model file)	0	0.25	G/3	G/2
9	F-FLOR-NUMB	F-FLORNUM-	Room/space identification number and symbol (copied from Architectural - Floor Plan model file)	0	0.25	G/3	G/2
CO2 Sprinkler System							
11	F-CO2S-EQPM	F-CO2SEQM-	Equipment	0	0.35	M/6	M/5
12	F-CO2S-PIPE	F-CO2SPIM-	CO2 piping or CO2 discharge nozzle piping	0	0.35	M/6	M/5
Aqueous Film Forming Foam System							
14	F-AFFF-EQPM	F-AFFFEQPM-	Equipment	0	0.35	82	18
15	F-AFFF-PIPE	F-AFFFPIPM-	Piping	0	0.35	82	18
Halon System							
17	F-HALN-EQPM	F-HALNEQM-	Halon equipment	0	0.35	22	22
18	F-HALN-PIPE	F-HALNPIM-	Halon piping	0	0.35	22	22
Inert Gas							
20	F-IGAS-EQPM	F-IGASEQM-	Inert gas equipment	0	0.35	162	33
21	F-IGAS-PIPE	F-IGASPIPM-	Inert gas piping	0	0.35	162	33
Sprinkler System							
23	F-SPRN-CLHD	F-SPRNCLM-	Sprinkler - ceiling heads	0	0.35	122	23
24	F-SPRN-OTHD	F-SPRNOTM-	Sprinkler - other heads	0	0.35	122	23
25	F-SPRN-PIPE	F-SPRNPIPM-	Sprinkler piping	SPRINK	0.50	C/4	C/7
26	F-SPRN-STAN	F-SPRNSTM-	Standpipe system	0	0.35	122	23
Water Supply and Distribution							
31	F-WATR-PIPE	F-WATRPIM-	Piping	FIRE	0.50	C/4	C/7
32	F-WATR-CONN	F-WATRCOM-	Fire department connections	0	0.35	122	23
33	F-WATR-HYDR	F-WATRHYM-	Hydrants	0	0.35	122	23
34	F-WATR-PUMP	F-WATRPUM-	Fire pumps	0	0.35	122	23
Demolition (used only in creating Existing/Demolition model files)							
56	F-STAT-DEMO-PHS1	F-----M-D----1	Demolition - phase 1	0	0.50	203	45
57	F-STAT-DEMO-PHS2	F-----M-D----2	Demolition - phase 2	0	0.50	83	42
58	F-STAT-DEMO-PHS3	F-----M-D----3	Demolition - phase 3	0	0.50	163	41

Note: V = Varies, NA = Not Applicable

Discipline: Fire Protection
Model File Type: Fire Alarm/Detection Plan

Level #	Level/Layer Naming		Level/Layer Description	Graphics			
	AIA Format	ISO Format		Line Style	Line Width (mm)	AutoCAD Line Color#	MicroStation Line Color#
General Information							
1	F-ANNO-DIMS	F-----DIP-	Witness/extension lines, dimension terminators, dimension text	0	V	V	V
2	F-ANNO-KEYN	F-----KEP	Reference keynotes with associated leaders	0	V	V	V
3	F-ANNO-NPLT	F-----NPP-	Non-plotting graphic information	V	0.18	B/5	B/1
4	F-ANNO-PATT	F-----PAP-	Miscellaneous patterning and hatching	0	0.18	Gr/8	Gr/9
5	F-ANNO-NOTE	F-----NOP-	General notes and general remarks	0	0.35	Y/2	Y/4
6	F-ANNO-SYMB	F-----SYP-	Miscellaneous symbols	V	0.35	M/6	M/5
7	F-ANNO-TEXT	F-----TEP-	Miscellaneous text and callouts with associated leaders	0	V	V	V
NA	F-ANNO-REFR	F-----RFP-	Reference files (AutoCAD users only, see Chapter 4)	NA	NA	NA	NA
Floor Information							
8	F-FLOR-IDEN	F-FLORIDM-	Room name, space identification text (copied from Architectural - Floor Plan model file)	0	0.25	G/3	G/2
9	F-FLOR-NUMB	F-FLORNUM-	Room/space identification number and symbol (copied from Architectural - Floor Plan model file)	0	0.25	G/3	G/2
Control Panels							
26	F-CTRL-PANL	F-CTRLPAM-	Control panels	0	0.50	23	46
Fire Alarm/Detection Equipment							
31	F-ALRM-MANL	F-ALRMMAM-	Manual fire alarm pull stations	0	0.50	23	46
33	F-ALRM-DTCT	F-ALRMDTM-	Smoke/heat/other detectors	0	0.50	23	46
34	F-ALRM-INDC	F-ALRMINM-	Indicating appliances	0	0.50	83	42
Smoke/Pressurization Control							
38	F-SMOK-DAMP	F-SMOKDAM-	Dampers	0	0.35	22	22
Demolition (used only in creating Existing/Demolition model files)							
56	F-STAT-DEMO-PHS1	F-----M-D-----1	Demolition - phase 1	0	0.50	203	45
57	F-STAT-DEMO-PHS2	F-----M-D-----2	Demolition - phase 2	0	0.50	83	42
58	F-STAT-DEMO-PHS3	F-----M-D-----3	Demolition - phase 3	0	0.50	163	41

Note: V = Varies, NA = Not Applicable

Discipline: Fire Protection

Model File Type: Details

Level #	Level/Layer Naming		Level/Layer Description	Graphic0			
	AIA Format	ISO Format		Line Style	Line Width (mm)	AutoCAD Line Color/#	MicroStation Line Color/#
General Information							
1	F-ANNO-DIMS	F----DIP-	Witness/extension lines, dimension terminators, dimension text	0	V	V	V
2	F-ANNO-KEYN	F----KEP-	Reference keynotes with associated leaders	0	V	V	V
3	F-ANNO-NPLT	F----NPP-	Non-plotting graphic information	V	0.18	B/5	B/1
4	F-ANNO-PATT	F----PAP-	Miscellaneous patterning and hatching	0	0.18	Gr/8	Gr/9
5	F-ANNO-NOTE	F----NOP-	General notes and general remarks	0	0.35	Y/2	Y/4
6	F-ANNO-SYMB	F----SYP-	Reference bubbles, matchlines and breaklines	V	0.35	M/6	M/5
7	F-ANNO-TEXT	F----TEP-	Detail title text, text and associated leaders, notes	V	V	V	V
Detail Information							
11	F-DETL-GRPH	F-DETLGRM-	Graphics, gridlines, non-text items	V	V	V	V
12	F-DETL-METR	F-DETLMEM-	Metric-specific dimensions and notes	0	0.35	Y/2	Y/4
13	F-DETL-INPD	F-DETLINM-	Inch-pound-specific dimensions and notes	0	0.35	Y/2	Y/4
Demolition (used only in creating Existing/Demolition model files)							
56	F-STAT-DEMO-PHS1	F-----M-D---1	Demolition - phase 1	0	0.50	203	45
57	F-STAT-DEMO-PHS2	F-----M-D---2	Demolition - phase 2	0	0.50	83	42
58	F-STAT-DEMO-PHS3	F-----M-D---3	Demolition - phase 3	0	0.50	163	41

Note: V = Varies

Discipline: Plumbing
Model File Type: Piping Plan

Level #	Level/Layer Naming		Level/Layer Description	Graphics			
	AIA Format	ISO Format		Line Style	Line Width (mm)	AutoCAD Line Color/#	MicroStation Line Color/#
General Information							
1	P-ANNO-DIMS	P-----DIP-	Witness/extension lines, dimension terminators, dimension text	0	V	V	V
2	P-ANNO-KEYN	P-----KEP-	Reference keynotes with associated leaders	0	V	V	V
3	P-ANNO-NPLT	P-----NPP-	Non-plotting graphic information	V	0.18	B/5	B/1
4	P-ANNO-PATT	P-----PAP-	Miscellaneous patterning and hatching	0	0.18	Gr/8	Gr/9
5	P-ANNO-NOTE	P-----NOP-	General notes and general remarks	0	0.35	Y/2	Y/4
6	P-ANNO-SYMB	P-----SYP-	Miscellaneous symbols	V	0.35	M/6	M/5
7	P-ANNO-TEXT	P-----TEP-	Miscellaneous text and callouts with associated leaders	0	V	V	V
NA	P-ANNO-REFR	P-----RFP-	Reference files (AutoCAD users only, see Chapter 4)	NA	NA	NA	NA
Floor Information							
8	P-FLOR-IDEN	P-FLORIDM-	Room name, space identification text (copied from Architectural - Floor Plan model file)	0	0.25	G/3	G/2
9	P-FLOR-NUMB	P-FLORNUM-	Room/space identification number and symbol (copied from Architectural - Floor Plan model file)	0	0.25	G/3	G/2
Domestic Water Piping System							
10	P-DOMW-ACCS	P-DOMWACM-	Equipment access doors	0	0.35	82	18
11	P-DOMW-CPIP	P-DOMWCMP-	Domestic cold water piping	CLDWTR	0.50	123	31
12	P-DOMW-EQPM	P-DOMWEQM-	Hot and cold water equipment	0	0.70	7	0
13	P-DOMW-FPIP	P-DOMWFPM-	Domestic filtered water piping	0	0.50	83	42
14	P-DOMW-HPIP	P-DOMWHPM-	Domestic hot water piping	HWTR, HWTRR	0.50	113	16
15	P-DOMW-RISR	P-DOMWRIM-	Domestic hot and cold water risers	2	0.25	G/3	G/2
Sanitary Drainage Piping							
20	P-SANR-COND	P-SANRCOM-	Condensate piping	0	0.50	83	42
22	P-SANR-EQPM	P-SANREQM-	Equipment (e.g., sand/oil/water separators)	0	0.70	204	37
23	P-SANR-FLDR	P-SANRFLM-	Floor drains, sinks, and cleanouts	0	0.35	M/6	M/5
24	P-SANR-PIPE	P-SANRPIM-	Piping	SSWAF	0.50	203	45
25	P-SANR-RISR	P-SANRRIM-	Sanitary risers	2	0.50	203	45
26	P-SANR-VENT	P-SANRVEM-	Vent piping	VENT	0.50	203	45
Storm Drainage Piping							
31	P-STRM-PIPE	P-STRMPIM-	Storm drain piping	STRAF	0.50	163	41
32	P-STRM-RFDR	P-STRMRFM-	Roof drains	0, ROOFDN	0.50	163	41
33	P-STRM-RISR	P-STRMRIM-	Storm drain risers	2	0.50	163	41
Compressed Air							
36	P-CMPA-EQPM	P-CMPAEQM-	Equipment	0	0.70	84	34
37	P-CMPA-PIPE	P-CMPAPIM-	Piping	CMPAIR	0.50	83	42
Fuel Systems							
38	P-FUEL-EQPM	P-FUELEQM-	Equipment	0	0.70	24	38
39	P-FUEL-NGAS	P-FUELNGM-	Natural gas piping	NTGASN	0.50	23	46
40	P-FUEL-FGAS	P-FUELFGM-	Fuel gas piping	LIQPET	0.50	23	46
41	P-FUEL-FOIL	P-FUELFOM-	Fuel oil piping	FUELOR, FUELOS, FUELOV	0.50	23	46
Medical/Dental Piping							
42	P-MDGS-EQPM	P-MDGSEQM-	Equipment	0	0.70	24	38
43	P-MDGS-PIPE	P-MDGSPIM-	Piping	OXYGEN, NITOXI, VACAIR	0.50	23	46
Laboratory Piping							
45	P-LGAS-EQPM	P-LGASEQM-	Equipment	0	0.70	24	38
46	P-LGAS-PIPE	P-LGASPIM-	Piping	OXYGEN, NITROG, HELIUM, HYDRGN, ACIDWS, DSTWTR, DIOWTR	0.50	23	46
Demolition (used only in creating Existing/Demolition model files)							
56	P-STAT-DEMO-PHS1	P-----M-D-----1	Demolition - phase 1	0	0.50	203	45
57	P-STAT-DEMO-PHS2	P-----M-D-----2	Demolition - phase 2	0	0.50	83	42
58	P-STAT-DEMO-PHS3	P-----M-D-----3	Demolition - phase 3	0	0.50	163	41
Other Discipline Information							
61	P-PENE-FLOR	P-PENEFLM-	Floor penetrations	2	0.25	G/3	G/2
62	P-PENE-ROOF	P-PENEROM-	Roof penetrations	2	0.25	R/1	R/3

Note: V = Varies, NA = Not Applicable

Discipline: Plumbing

Model File Type: Details

Level #	Level/Layer Naming		Level/Layer Description	Graphics			
	AIA Format	ISO Format		Line Style	Line Width (mm)	AutoCAD Line Color/#	MicroStation Line Color/#
General Information							
1	P-ANNO-DIMS	P-----DIP-	Witness/extension lines, dimension terminators, dimension text	0	V	V	V
2	P-ANNO-KEYN	P-----KEP-	Reference keynotes with associated leaders	0	V	V	V
3	P-ANNO-NPLT	P-----NPP-	Non-plotting graphic information	V	0.18	B/5	B/1
4	P-ANNO-PATT	P-----PAP-	Miscellaneous patterning and hatching	0	0.18	Gr/8	Gr/9
5	P-ANNO-NOTE	P-----NOP-	General notes and general remarks	0	0.35	Y/2	Y/4
6	P-ANNO-SYMB	P-----SYP-	Reference bubbles, matchlines and breaklines	V	0.35	M/6	M/5
7	P-ANNO-TEXT	P-----TEP-	Detail title text, text and associated leaders, notes	V	V	V	V
Detail Information							
11	P-DETL-GRPH	P-DETLGRM-	Graphics, gridlines, non-text items	V	V	V	V
12	P-DETL-METR	P-DETLMEM-	Metric-specific dimensions and notes	0	0.35	Y/2	Y/4
13	P-DETL-INPD	P-DETLINM-	Inch-pound-specific dimensions and notes	0	0.35	Y/2	Y/4
Demolition (used only in creating Existing/Demolition model files)							
56	P-STAT-DEMO-PHS1	P-----M-D---1	Demolition - phase 1	0	0.50	203	45
57	P-STAT-DEMO-PHS2	P-----M-D---2	Demolition - phase 2	0	0.50	83	42
58	P-STAT-DEMO-PHS3	P-----M-D---3	Demolition - phase 3	0	0.50	163	41

Note: V = Varies

Discipline: Plumbing

Model File Type: Riser Diagrams

Level #	Level/Layer Naming		Level/Layer Description	Graphics			
	AIA Format	ISO Format		Line Style	Line Width (mm)	AutoCAD Line Color/#	MicroStation Line Color/#
General Information							
1	P-ANNO-DIMS	P-----DIP-	Witness/extension lines, dimension terminators, dimension text	0	V	V	V
2	P-ANNO-KEYN	P-----KEP-	Reference keynotes with associated leaders	0	V	V	V
3	P-ANNO-NPLT	P-----NPP-	Non-plotting graphic information	V	0.18	B/5	B/1
4	P-ANNO-PATT	P-----PAP-	Miscellaneous patterning and hatching	0	0.18	Gr/8	Gr/9
5	P-ANNO-NOTE	P-----NOP-	General notes and general remarks	0	0.35	Y/2	Y/4
6	P-ANNO-SYMB	P-----SYP-	Miscellaneous symbols	V	0.35	M/6	M/5
7	P-ANNO-TEXT	P-----TEP-	Miscellaneous text and callouts with associated leaders	0	V	V	V
NA	P-ANNO-REFR	P-----RFP-	Reference files (AutoCAD users only, see Chapter 4)	NA	NA	NA	NA
Diagram Information							
11	P-DIAG-GRPH	P-DIAGGRM-	Graphics, gridlines, non-text items	0, 2	V	V	V
12	P-DIAG-METR	P-DIAGMEM-	Metric-specific dimensions and notes	0	0.25	R/1	R/3
13	P-DIAG-INPD	P-DIAGINM-	Inch-pound-specific dimensions and notes	0	0.25	R/1	R/3
Other Discipline Information							
60	P-DISC-INFO	P-DISCINM-	Information and notes for other disciplines	V	V	V	V

Note: V = Varies, NA = Not Applicable

Discipline: Mechanical
Model File Type: HVAC Plan

Level #	Level/Layer Naming		Level/Layer Description	Graphics			
	AIA Format	ISO Format		Line Style	Line Width (mm)	AutoCAD Line Color#	MicroStation Line Color#
General Information							
1	M-ANNO-DIMS	M-----DIP-	Witness/extension lines, dimension terminators, dimension text	0	V	V	V
2	M-ANNO-KEYN	M-----KEP-	Reference keynotes with associated leaders	0	V	V	V
3	M-ANNO-NPLT	M-----NPP-	Non-plotting graphic information	V	0.18	B/5	B/1
4	M-ANNO-PATT	M-----PAP-	Miscellaneous patterning and hatching	0	0.18	Gr/8	Gr/9
5	M-ANNO-NOTE	M-----NOP-	General notes and general remarks	0	0.35	Y/2	Y/4
6	M-ANNO-SYMB	M-----SYP-	Miscellaneous symbols	V	0.35	M/6	M/5
7	M-ANNO-TEXT	M-----TEP-	Miscellaneous text and callouts with associated leaders	0	V	V	V
NA	M-ANNO-REFR	M-----RFP-	Reference files (AutoCAD users only, see Chapter 4)	NA	NA	NA	NA
Floor Information							
8	M-FLOR-IDEN	M-FLORIDM-	Room name, space identification text (copied from Architectural - Floor Plan model file)	0	0.25	G/3	G/2
9	M-FLOR-NUMB	M-FLORNUM-	Room/space identification number and symbol (copied from Architectural - Floor Plan model file)	0	0.25	G/3	G/2
Ductwork and Equipment							
10	M-HVAC-ACCS	M-HVACACM-	Equipment access doors	0, 1, 2	0.25	G/3	G/2
11	M-HVAC-DAMP	M-HVACDAM-	Fire and smoke dampers	0	0.25	R/1	R/3
12	M-HVAC-EQPM	M-HVACEQM-	Equipment	0	0.35	Y/2	Y/4
13	M-HVAC-ROOF	M-HVACROM-	Roof mounted HVAC equipment	0	0.35	Y/2	Y/4
14	M-HVAC-RETN	M-HVACREM-	Return ductwork	V	0.50	23	46
15	M-HVAC-SUPP	M-HVACSUM-	Supply ductwork	V	0.50	C/4	C/7
16	M-HVAC-IDEN	M-HVACIDM-	Duct sizes and pressure classes	V	0.35	M/6	M/5
Diffusers, Registers, and Grilles							
17	M-HVAC-CDFF	M-HVACCDM-	Ceiling diffusers, registers, and grilles	0	0.35	12	27
18	M-HVAC-TAGS	M-HVACTAM-	Diffuser/register/grille tags and air flow arrows	0	0.35	M/6	M/5
19	M-HVAC-WDFD	M-HVACWDM-	Wall diffusers, registers, and grilles	0	0.35	Y/2	Y/4
20	M-HVAC-FDFF	M-HVACFDM-	Floor diffusers, registers, and grilles	0	0.35	162	33
Exhaust							
24	M-EXHS-DUCT	M-EXHSDUM-	Exhaust ductwork	V	0.50	83	42
Dust and Fume Collection Systems							
28	M-DUST-DUCT	M-DUSTDUM-	Dust and fume ductwork	0	0.50	203	45
Chilled Water System							
31	M-CWTR-PIPE	M-CWTRPIM-	Piping (includes fittings, valves)	CWR, CWS	0.50	163	41
Hot Water Heating System							
33	M-HWTR-PIPE	M-HWTRPIM-	Piping (includes fittings, valves)	HWR, HWS	0.50	113	16
Condensate							
34	M-COND-PIPE	M-CONDPIM-	Condensate piping (includes fittings, valves)	CDRNAS	0.50	83	42
Condenser Water System							
36	M-CNDW-PIPE	M-CNDWPIM-	Condenser water piping	CONDWR, CONDWS	0.50	83	42
Controls							
38	M-CONT-WIRE	M-CONTWIM-	Low voltage wiring	1, 2	0.25	R/1	R/3
39	M-CONT-THER	M-CONTTHM-	Thermostats, controls, instrumentation, and sensors	0	0.25	R/1	R/3
Dual Temperature System							
41	M-DUAL-PIPE	M-DUALPIM-	Piping (includes fittings, valves)	DTR, DTS	0.50	23	46
Steam System							
43	M-STEM-PIPE	M-STEMPIM-	Steam piping	STEAM	0.50	113	16
Refrigeration System							
45	M-REFG-PIPE	M-REFGPIM-	Piping (includes fittings, valves)	REFRD, REFRL, REFRS	0.50	163	41
Energy Recovery System							
47	M-RCOV-PIPE	M-RCOVPIM-	Piping (includes fittings, valves)	0	0.50	203	45
Chemical Treatment System							
49	M-CHEM-PIPE	M-CHEMPIM-	Piping (includes fittings, valves)	0	0.50	123	31
Geothermal Heat Pump System							
51	M-GTHP-PIPE	M-GTHPPIM-	Piping (includes fittings, valves)	0	0.50	203	45

Discipline: Mechanical

Model File Type: HVAC Plan

Demolition (used only in creating Existing/Demolition model files)						
56	M-STAT-DEMO-PHS1	M-----M-D----1	Demolition - phase 1	0	0.50	203 45
57	M-STAT-DEMO-PHS2	M-----M-D----2	Demolition - phase 2	0	0.50	83 42
58	M-STAT-DEMO-PHS3	M-----M-D----3	Demolition - phase 3	0	0.50	163 41
Other Discipline Information						
59	M-DISC-INFO	M-DISCINM-	Clearances and working space information	0, 1	0.25	G/3 G/2
61	M-PENE-FLOR	M-PENEFLM-	Floor penetrations	2	0.25	G/3 G/2
62	M-PENE-ROOF	M-PENEROM-	Roof penetrations	2	0.25	R/1 R/3

Note: V = Varies, NA = Not Applicable

Discipline: Mechanical
Model File Type: Specialty Piping and Equipment

Level #	Level/Layer Naming		Level/Layer Description	Graphics			
	AIA Format	ISO Format		Line Style	Line Width (mm)	AutoCAD Line Color#	MicroStation Line Color#
General Information							
1	M-ANNO-DIMS	M-----DIP-	Witness/extension lines, dimension terminators, dimension text	0	V	V	V
2	M-ANNO-KEYN	M-----KEP-	Reference keynotes with associated leaders	0	V	V	V
3	M-ANNO-NPLT	M-----NPP-	Non-plotting graphic information	V	0.18	B/5	B/1
4	M-ANNO-PATT	M-----PAP-	Miscellaneous patterning and hatching	0	0.18	Gr/8	Gr/9
5	M-ANNO-NOTE	M-----NOP-	General notes and general remarks	0	0.35	Y/2	Y/4
6	M-ANNO-SYMB	M-----SYP-	Miscellaneous symbols	V	0.35	M/6	M/5
7	M-ANNO-TEXT	M-----TEP-	Miscellaneous text and callouts with associated leaders	0	V	V	V
NA	M-ANNO-REFR	M-----RFP-	Reference files (AutoCAD users only, see Chapter 4)	NA	NA	NA	NA
Floor Information							
8	M-FLOR-IDEN	M-FLORIDM-	Room name, space identification text (copied from Architectural - Floor Plan model file)	0	0.25	G/3	G/2
9	M-FLOR-NUMB	M-FLORNUM-	Room/space identification number and symbol (copied from Architectural - Floor Plan model file)	0	0.25	G/3	G/2
Brine Systems							
11	M-BRIN-EQPM	M-BRINEQM-	Brine system equipment	0	0.35	M/6	M/5
12	M-BRIN-PIPE	M-BRINPIP-	Brine system piping	BRINER, BRINES	0.35	Y/2	Y/4
Anti-freeze							
19	M-AFRZ-PIPE	M-AFRZPIM-	Anti-freeze piping	0	0.35	82	18
20	M-AFRZ-WAST	M-AFRZWAM-	Waste anti-freeze piping	0	0.35	82	18
Hydraulic Systems							
22	M-HYDR-EQPM	M-HYDREQM-	Hydraulic system equipment	0	0.35	M/6	M/5
23	M-HYDR-PIPE	M-HYDRPIM-	Hydraulic system piping	0	0.35	Y/2	Y/4
Industrial Waste Piping							
25	M-ACID-EQPM	M-ACIDEQM-	Acid, alkaline, and oil waste equipment	0	0.35	M/6	M/5
26	M-ACID-PIPE	M-ACIDPIM-	Acid, alkaline, and oil waste piping	ACIDWS	0.35	Y/2	Y/4
27	M-ACID-VENT	M-ACIDVEM-	Acid, alkaline, and oil waste vent piping	2	0.35	Y/2	Y/4
Insulating (Transformer) Oil							
28	M-INSL-EQPM	M-INSLEQM-	Insulating oil equipment	0	0.35	M/6	M/5
29	M-INSL-PIPE	M-INSLPIM-	Insulating oil piping	0	0.35	Y/2	Y/4
Lubrication Oil							
33	M-LUBE-EQPM	M-LUBEEQM-	Lubrication oil equipment	0	0.35	M/6	M/5
34	M-LUBE-PIPE	M-LUBEPIM-	Lubrication oil piping	0	0.35	Y/2	Y/4
Process Piping							
40	M-PROC-EQPM	M-PROCEQM-	Equipment	0	0.35	M/6	M/5
42	M-PROC-PIPE	M-PROCPIM-	Process piping	0	0.35	Y/2	Y/4
Raw Water Piping							
44	M-RWTR-EQPM	M-RWTREQM-	Raw water equipment	0	0.35	M/6	M/5
45	M-RWTR-PIPE	M-RWTRPIM-	Raw water piping	0	0.35	Y/2	Y/4
Demolition (used only in creating Existing/Demolition model files)							
56	M-STAT-DEMO-PHS1	M-----M-D---1	Demolition - phase 1	0	0.50	203	45
57	M-STAT-DEMO-PHS2	M-----M-D---2	Demolition - phase 2	0	0.50	83	42
58	M-STAT-DEMO-PHS3	M-----M-D---3	Demolition - phase 3	0	0.50	163	41
Other Discipline Information							
59	M-DISC-INFO	M-DISCINM-	Clearances and working space information	0, 1	0.25	G/3	G/2
61	M-PENE-FLOR	M-PENEFLM-	Floor penetrations	2	0.25	G/3	G/2
62	M-PENE-ROOF	M-PENEROM-	Roof penetrations	2	0.25	R/1	R/3

Note: V = Varies, NA = Not Applicable

Discipline: Mechanical

Model File Type: HTCW Utilities Plan

Level #	Level/Layer Naming		Level/Layer Description	Graphics			
	AIA Format	ISO Format		Line Style	Line Width (mm)	AutoCAD Line Color#	MicroStation Line Color#
General Information							
1	M-ANNO-DIMS	M-----DIP-	Witness/extension lines, dimension terminators, dimension text	0	V	V	V
2	M-ANNO-KEYN	M-----KEP-	Reference keynotes with associated leaders	0	V	V	V
3	M-ANNO-NPLT	M-----NPP-	Non-plotting graphic information	V	0.18	B/5	B/1
4	M-ANNO-PATT	M-----PAP-	Miscellaneous patterning and hatching	0	0.18	Gr/8	Gr/9
5	M-ANNO-NOTE	M-----NOP-	General notes and general remarks	0	0.35	Y/2	Y/4
6	M-ANNO-SYMB	M-----SYP-	Miscellaneous symbols	V	0.35	M/6	M/5
7	M-ANNO-TEXT	M-----TEP-	Miscellaneous text and callouts with associated leaders	0	V	V	V
NA	M-ANNO-REFR	M-----RFP-	Reference files (AutoCAD users only, see Chapter 4)	NA	NA	NA	NA
Devices							
11	M-HTCW-DEVC	M-HTCWDEM-	Rigid anchors, anchor guides, rectifiers, reducers, markers, meters, pumps, regulators, tanks, and valves	0	0.35	M/6	M/5
Stations							
16	M-HTCW-PUMP	M-HTCWPU-	Pump stations	0	0.35	M/6	M/5
18	M-HTCW-STNS-IDEN	M-HTCWSIM-	Identifier tags, symbol modifier, and tex	0	0.35	Y/2	Y/4
Plants							
19	M-HTCW-CHLP	M-HTCWCPM-	Chilled water plant	0	0.35	M/6	M/5
20	M-HTCW-HTPP	M-HTCWHPM-	High temperature water plant	0	0.35	M/6	M/5
21	M-HTCW-PLNT-IDEN	M-HTCWPIM-	Identifier tags, symbol modifier, and tex	0	0.35	Y/2	Y/4
Junction Boxes							
22	M-HTCW-JBOX	M-HTCWJBM-	Junction boxes, manholes, handholes, test boxes	0	0.25	R/1	R/3
Pits							
25	M-HTCW-PITS	M-HTCWPTM-	Valve pits/vaults, steam pits	0	0.25	G/3	G/2
Piping							
32	M-HTCW-ABND	M-HTCWABM-	Abandoned piping	2	0.35	M/6	M/5
33	M-HTCW-FLOW	M-HTCWFLM-	Flow direction arrows	0	0.25	G/3	G/2
34	M-HTCW-CHLL	M-HTCWCHM-	Main chilled water piping	0	0.35	M/6	M/5
35	M-HTCW-CHLS	M-HTCWCSM-	Chilled water service piping	0	0.25	G/3	G/2
37	M-HTCW-FTTG	M-HTCWFTM-	Caps and flanges	0	0.35	M/6	M/5
38	M-HTCW-HTPL	M-HTCWHM-	Main high temperature piping	0	0.25	R/1	R/3
39	M-HTCW-HTPS	M-HTCWHSM-	High temperature service piping	0	0.25	G/3	G/2
40	M-HTCW-IDEN	M-HTCWIDM-	Identifier tags, symbol modifier, and text	0	0.35	Y/2	Y/4
41	M-HTCW-LTPL	M-HTCWLTM-	Main low temperature piping	0	0.35	Y/2	Y/4
42	M-HTCW-LTPS	M-HTCWLSM-	Low temperature service piping	0	0.25	G/3	G/2
45	M-HTCW-RTRN	M-HTCWRTM-	Return for all HTCW lines	0	0.18	B/5	B/1
48	M-HTCW-STML	M-HTCWSTM-	Main steam piping	0	0.25	R/1	R/3
49	M-HTCW-STMS	M-HTCWSSM-	Steam service piping	0	0.25	G/3	G/2
Geothermal Heat Pump System							
50	M-GTHP-EQPM	M-GTHPEQM-	Equipment	0	0.35	M/6	M/5
51	M-GTHP-PIPE	M-GTHPPIM-	Piping (includes fittings, valves)	0	0.35	M/6	M/5
Demolition (used only in creating Existing/Demolition model files)							
56	M-STAT-DEMO-PHS1	M-----M-D----1	Demolition - phase 1	0	0.50	203	45
57	M-STAT-DEMO-PHS2	M-----M-D----2	Demolition - phase 2	0	0.50	83	42
58	M-STAT-DEMO-PHS3	M-----M-D----3	Demolition - phase 3	0	0.50	163	41

Note: V = Varies, NA = Not Applicable

Discipline: Mechanical

Model File Type: Material Handling

Level #	Level/Layer Naming		Level/Layer Description	Graphics			
	AIA Format	ISO Format		Line Style	Line Width (mm)	AutoCAD Line Color/#	MicroStation Line Color/#
General Information							
1	M-ANNO-DIMS	M-----DIP-	Witness/extension lines, dimension terminators, dimension text	0	V	V	V
2	M-ANNO-KEYN	M-----KEP-	Reference keynotes with associated leaders	0	V	V	V
3	M-ANNO-NPLT	M-----NPP-	Non-plotting graphic information	V	0.18	B/5	B/1
4	M-ANNO-PATT	M-----PAP-	Miscellaneous patterning and hatching	0	0.18	Gr/8	Gr/9
5	M-ANNO-NOTE	M-----NOP-	General notes and general remarks	0	0.35	Y/2	Y/4
6	M-ANNO-SYMB	M-----SYP-	Miscellaneous symbols	V	0.35	M/6	M/5
7	M-ANNO-TEXT	M-----TEP-	Miscellaneous text and callouts with associated leaders	0	V	V	V
NA	M-ANNO-REFR	M-----RFP-	Reference files (AutoCAD users only, see Chapter 4)	NA	NA	NA	NA
Material Handling							
43	M-MATL-CRAN	M-MATLCRM-	Bridge cranes, jib cranes, and monorails	0	0.35	Y/2	Y/4
44	M-MATL-HOIS	M-MATLHOM-	Hoists and hooks	0	0.35	Y/2	Y/4
45	M-MATL-LIFT	M-MATLLIM-	Miscellaneous lifting equipmen	0	0.35	M/6	M/5
Demolition (used only in creating Existing/Demolition model files)							
56	M-STAT-DEMO-PHS1	M-----M-D----1	Demolition - phase 1	0	0.50	203	45
57	M-STAT-DEMO-PHS2	M-----M-D----2	Demolition - phase 2	0	0.50	83	42
58	M-STAT-DEMO-PHS3	M-----M-D----3	Demolition - phase 3	0	0.50	163	41

Note: V = Varies, NA = Not Applicable

Discipline: Mechanical

Model File Type: Machine Design

Level #	Level/Layer Naming		Level/Layer Description	Graphics			
	AIA Format	ISO Format		Line Style	Line Width (mm)	AutoCAD Line Color/#	MicroStation Line Color/#
General Information							
1	M-ANNO-DIMS	M-----DIP-	Witness/extension lines, dimension terminators, dimension text	0	V	V	V
2	M-ANNO-KEYN	M-----KEP-	Reference keynotes with associated leaders	0	V	V	V
3	M-ANNO-NPLT	M-----NPP-	Non-plotting graphic information	V	0.18	B/5	B/1
4	M-ANNO-PATT	M-----PAP-	Miscellaneous patterning and hatching	0	0.18	Gr/8	Gr/9
5	M-ANNO-NOTE	M-----NOP-	General notes and general remarks	0	0.35	Y/2	Y/4
6	M-ANNO-SYMB	M-----SYP-	Miscellaneous symbols	V	0.35	M/6	M/5
7	M-ANNO-TEXT	M-----TEP-	Miscellaneous text and callouts with associated leaders	0	V	V	V
NA	M-ANNO-REFR	M-----RFP-	Reference files (AutoCAD users only, see Chapter 4)	NA	NA	NA	NA
Machine Design							
11	M-MACH-BASE	M-MACHBAM-	Machinery bases	0	0.35	Y/2	Y/4
12	M-MACH-COMP	M-MACHCOM-	Miscellaneous machinery parts and components	0	0.35	Y/2	Y/4
13	M-MACH-EXST	M-MACHEXM-	Existing machinery	0	0.25	G/3	G/2
14	M-MACH-FAST	M-MACHFAM-	Fasteners, nuts, and bolts	0	0.35	Y/2	Y/4
15	M-MACH-LROT	M-MACHLRM-	Large rotating machinery (turbine and pump outlines)	0	0.35	M/6	M/5
16	M-MACH-MOTR	M-MACHMOM-	Machinery motors	0	0.35	M/6	M/5
Demolition (used only in creating Existing/Demolition model files)							
56	M-STAT-DEMO-PHS1	M-----M-D----1	Demolition - phase 1	0	0.50	203	45
57	M-STAT-DEMO-PHS2	M-----M-D----2	Demolition - phase 2	0	0.50	83	42
58	M-STAT-DEMO-PHS3	M-----M-D----3	Demolition - phase 3	0	0.50	163	41

Note: V = Varies, NA = Not Applicable

Discipline: Mechanical
Model File Type: Elevations

Level #	Level/Layer Naming		Level/Layer Description	Graphics			
	AIA Format	ISO Format		Line Style	Line Width (mm)	AutoCAD Line Color/#	MicroStation Line Color/#
General Information							
1	M-ANNO-DIMS	M-----DIP-	Witness/extension lines, dimension terminators, dimension text	0	V	V	V
2	M-ANNO-KEYN	M-----KEP-	Reference keynotes with associated leaders	0	V	V	V
3	M-ANNO-NPLT	M-----NPP-	Non-plotting graphic information	V	0.18	B/5	B/1
4	M-ANNO-PATT	M-----PAP-	Miscellaneous patterning and hatching	0	0.18	Gr/8	Gr/9
5	M-ANNO-NOTE	M-----NOP-	General notes and general remarks	0	0.35	Y/2	Y/4
6	M-ANNO-SYMB	M-----SYP-	Miscellaneous symbols	V	0.35	M/6	M/5
7	M-ANNO-TEXT	M-----TEP-	Miscellaneous text and callouts with associated leaders	0	V	V	V
NA	M-ANNO-REFR	M-----RFP-	Reference files (AutoCAD users only, see Chapter 4)	NA	NA	NA	NA
Elevations							
38	M-ELEV-FIXT	M-ELEV-FIM-	Miscellaneous fixtures	0	0.35	M/6	M/5
40	M-ELEV-IDEN	M-ELEV-IDM-	Component identification numbers	0	0.35	Y/2	Y/4
41	M-ELEV-OTLN	M-ELEV-OTM-	Building outlines	0	0.35	M/6	M/5
42	M-ELEV-PATT	M-ELEV-PAM-	Textures and hatch patterns	0	0.18	Gr/8	Gr/9
43	M-ELEV-PFIX	M-ELEV-PFM-	Plumbing fixtures	0	0.35	M/6	M/5
Demolition (used only in creating Existing/Demolition model files)							
56	M-STAT-DEMO-PHS1	M-----M-D---1	Demolition - phase 1	0	0.50	203	45
57	M-STAT-DEMO-PHS2	M-----M-D---2	Demolition - phase 2	0	0.50	83	42
58	M-STAT-DEMO-PHS3	M-----M-D---3	Demolition - phase 3	0	0.50	163	41

Note: V = Varies, NA = Not Applicable

Discipline: Mechanical

Model File Type: Sections

Level #	Level/Layer Naming		Level/Layer Description	Graphics			
	AIA Format	ISO Format		Line Style	Line Width (mm)	AutoCAD Line Color/#	MicroStation Line Color/#
General Information							
1	M-ANNO-DIMS	M-----DIP-	Witness/extension lines, dimension terminators, dimension text	0	V	V	V
2	M-ANNO-KEYN	M-----KEP-	Reference keynotes with associated leaders	0	V	V	V
3	M-ANNO-NPLT	M-----NPP-	Non-plotting graphic information	V	0.18	B/5	B/1
4	M-ANNO-PATT	M-----PAP-	Miscellaneous patterning and hatching	0	0.18	Gr/8	Gr/9
5	M-ANNO-NOTE	M-----NOP-	General notes and general remarks	0	0.35	Y/2	Y/4
6	M-ANNO-SYMB	M-----SYP-	Miscellaneous symbols	V	0.35	M/6	M/5
7	M-ANNO-TEXT	M-----TEP-	Miscellaneous text and callouts with associated leaders	0	V	V	V
NA	M-ANNO-REFR	M-----RFP-	Reference files (AutoCAD users only, see Chapter 4)	NA	NA	NA	NA
Sections							
45	M-SECT-IDEN	M-SECTIDM-	Component identification numbers	0	0.35	Y/2	Y/4
46	M-SECT-MBND	M-SECTMBM-	Material beyond section cut	V	0.18	B/5	B/1
47	M-SECT-MCUT	M-SECTMCM-	Material cut by section	0	0.50	C/4	C/7
48	M-SECT-PATT	M-SECTPAM-	Textures and hatch patterns	0	0.18	Gr/8	Gr/9
Demolition (used only in creating Existing/Demolition model files)							
56	M-STAT-DEMO-PHS1	M-----M-D----1	Demolition - phase 1	0	0.50	203	45
57	M-STAT-DEMO-PHS2	M-----M-D----2	Demolition - phase 2	0	0.50	83	42
58	M-STAT-DEMO-PHS3	M-----M-D----3	Demolition - phase 3	0	0.50	163	41

Note: V = Varies, NA = Not Applicable

Discipline: Mechanical

Model File Type: Details

Level #	Level/Layer Naming		Level/Layer Description	Graphic0			
	AIA Format	ISO Format		Line Style	Line Width (mm)	AutoCAD Line Color/#	MicroStation Line Color/#
General Information							
1	M-ANNO-DIMS	M-----DIP-	Witness/extension lines, dimension terminators, dimension text	0	V	V	V
2	M-ANNO-KEYN	M-----KEP-	Reference keynotes with associated leaders	0	V	V	V
3	M-ANNO-NPLT	M-----NPP-	Non-plotting graphic information	V	0.18	B/5	B/1
4	M-ANNO-PATT	M-----PAP-	Miscellaneous patterning	0	0.18	Gr/8	Gr/9
5	M-ANNO-NOTE	M-----NOP-	General notes and general remarks	0	0.35	Y/2	Y/4
6	M-ANNO-SYMB	M-----SYP-	Reference bubbles, matchlines and breaklines	V	0.35	M/6	M/5
7	M-ANNO-TEXT	M-----TEP-	Detail title text, text and associated leaders, notes	V	V	V	V
Detail Information							
11	M-DETL-GRPH	M-DETLGRM-	Graphics, gridlines, non-text items	V	V	V	V
12	M-DETL-METR	M-DETLMEM-	Metric-specific dimensions and notes	0	0.25	G/3	G/2
13	M-DETL-INPD	M-DETLINM-	Inch-pound-specific dimensions and notes	0	0.25	R/1	R/3
Demolition (used only in creating Existing/Demolition model files)							
56	M-STAT-DEMO-PHS1	M-----M-D---1	Demolition - phase 1	0	0.50	203	45
57	M-STAT-DEMO-PHS2	M-----M-D---2	Demolition - phase 2	0	0.50	83	42
58	M-STAT-DEMO-PHS3	M-----M-D---3	Demolition - phase 3	0	0.50	163	41

Note: V = Varies, NA = Not Applicable

Discipline: Mechanical

Model File Type: Control Diagrams

Level #	Level/Layer Naming		Level/Layer Description	Graphics			
	AIA Format	ISO Format		Line Style	Line Width (mm)	AutoCAD Line Color/#	MicroStation Line Color/#
General Information							
1	M-ANNO-DIMS	M-----DIP-	Witness/extension lines, dimension terminators, dimension text	0	V	V	V
2	M-ANNO-KEYN	M-----KEP-	Reference keynotes with associated leaders	0	V	V	V
3	M-ANNO-NPLT	M-----NPP-	Non-plotting graphic information	V	0.18	B/5	B/1
4	M-ANNO-PATT	M-----PAP-	Miscellaneous patterning and hatching	0	0.18	Gr/8	Gr/9
5	M-ANNO-NOTE	M-----NOP-	General notes and general remarks	0	0.35	Y/2	Y/4
6	M-ANNO-SYMB	M-----SYP-	Miscellaneous symbols	V	0.35	M/6	M/5
7	M-ANNO-TEXT	M-----TEP-	Miscellaneous text and callouts with associated leaders	0	V	V	V
NA	M-ANNO-REFR	M-----RFP-	Reference files (AutoCAD users only, see Chapter 4)	NA	NA	NA	NA
Diagram Information							
11	M-DIAG-GRPH	M-DIAGGRM-	Graphics, gridlines, non-text items	V	V	V	V
12	M-DIAG-METR	M-DIAGMEM-	Metric-specific dimensions and notes	0	0.25	G/3	G/2
13	M-DIAG-INPD	M-DIAGINM-	Inch-pound-specific dimensions and notes	0	0.25	R/1	R/3
Demolition (used only in creating Existing/Demolition model files)							
56	M-STAT-DEMO-PHS1	M-----M-D----1	Demolition - phase 1	0	0.50	203	45
57	M-STAT-DEMO-PHS2	M-----M-D----2	Demolition - phase 2	0	0.50	83	42
58	M-STAT-DEMO-PHS3	M-----M-D----3	Demolition - phase 3	0	0.50	163	41

Note: V = Varies, NA = Not Applicable

Discipline: Electrical
Model File Type: Lighting Plan

Level #	Level/Layer Naming		Level/Layer Description	Graphics			
	AIA Format	ISO Format		Line Style	Line Width (mm)	AutoCAD Line Color#	MicroStation Line Color#
General Information							
1	E-ANNO-DIMS	E-----DIP-	Witness/extension lines, dimension terminators, dimension text	0	V	V	V
2	E-ANNO-KEYN	E-----KEP-	Reference keynotes with associated leaders	0	V	V	V
3	E-ANNO-NPLT	E-----NPP-	Non-plotting graphic information	V	0.18	B/5	B/1
4	E-ANNO-PATT	E-----PAP-	Miscellaneous patterning and hatching	0	0.18	Gr/8	Gr/9
5	E-ANNO-NOTE	E-----NOP-	General notes and general remarks	0	0.35	Y/2	Y/4
6	E-ANNO-SYMB	E-----SYP-	Miscellaneous symbols	V	0.35	M/6	M/5
7	E-ANNO-TEXT	E-----TEP-	Miscellaneous text and callouts with associated leaders	0	V	V	V
NA	E-ANNO-REFR	E-----RFP-	Reference files (AutoCAD users only, see Chapter 4)	NA	NA	NA	NA
Floor Information							
8	E-FLOR-IDEN	E-FLORIDM-	Room name, space identification text (copied from Architectural - Floor Plan model file)	0	0.25	G/3	G/2
9	E-FLOR-NUMB	E-FLORNUM-	Room/space identification number and symbol (copied from Architectural - Floor Plan model file)	0	0.25	G/3	G/2
Electrical Equipment							
10	E-LITE-PANL	E-LITEPAM-	Main distribution panels, switchboards, lighting panels	0	0.50	C/4	C/7
Junction Boxes							
14	E-LITE-JBOX	E-LITEJBM-	Junction boxes	0	0.50	83	42
Switches							
16	E-LITE-SWCH	E-LITESWM-	Lighting contactors, photoelectric controls, low-voltage lighting controls, etc.	0	0.50	163	41
Lighting							
18	E-LITE-CLNG	E-LITECLM-	Ceiling mounted (surface/pendant) fixtures	0	0.50	203	45
19	E-LITE-EMER	E-LITEEMM-	Emergency fixtures (outline of light (if ceiling mounted) should go on E-LITE-CLNG)	0	0.50	23	46
20	E-LITE-EXIT	E-LITEEXM-	Exit fixtures (outline of light (if ceiling mounted) should go on E-LITE-CLNG)	0	0.50	203	45
21	E-LITE-FLOR	E-LITEFLM-	Floor mounted fixtures (e.g., stage)	0	0.50	203	45
22	E-LITE-IDEN	E-LITEIDM-	Light fixture identifier tags	0	0.35	Y/2	Y/4
24	E-LITE-ROOF	E-LITEROM-	Roof lighting	0	0.50	203	45
26	E-LITE-SPCL	E-LITESPM-	Special fixtures	0	0.50	203	45
27	E-LITE-WALL	E-LITEWAM-	Wall mounted fixtures	0	0.50	203	45
Circuit Lines							
47	E-LITE-CIRC	E-LITECIM-	Lighting circuits (including crosslines and homeruns)	0	0.50	83	42
48	E-LITE-CIRC-NUMB	E-LITECNM-	Lighting circuit numbers (e.g., panel/circuit number, wire/conduit size)	0	0.35	Y/2	Y/4
Demolition (used only in creating Existing/Demolition model files)							
56	E-STAT-DEMO-PHS1	E-----M-D----1	Demolition - phase 1	0	0.50	203	45
57	E-STAT-DEMO-PHS2	E-----M-D----2	Demolition - phase 2	0	0.50	83	42
58	E-STAT-DEMO-PHS3	E-----M-D----3	Demolition - phase 3	0	0.50	163	41
Other Discipline Information							
60	E-DISC-INFO	E-DISCINM-	Clearances and working space information (NEC code, etc.)	0	0.25	G/3	G/2

Note: V = Varies, NA = Not Applicable

Discipline: Electrical
Model File Type: Power Plan

Level #	Level/Layer Naming		Level/Layer Description	Graphics			
	AIA Format	ISO Format		Line Style	Line Width (mm)	AutoCAD Line Color/#	MicroStation Line Color/#
General Information							
1	E-ANNO-DIMS	E-----DIP-	Witness/extension lines, dimension terminators, dimension text	0	V	V	V
2	E-ANNO-KEYN	E-----KEP-	Reference keynotes with associated leaders	0	V	V	V
3	E-ANNO-NPLT	E-----NPP-	Non-plotting graphic information	V	0.18	B/5	B/1
4	E-ANNO-PATT	E-----PAP-	Miscellaneous patterning and hatching	0	0.18	Gr/8	Gr/9
5	E-ANNO-NOTE	E-----NOP-	General notes and general remarks	0	0.35	Y/2	Y/4
6	E-ANNO-SYMB	E-----SYP-	Miscellaneous symbols	V	0.35	M/6	M/5
7	E-ANNO-TEXT	E-----TEP-	Miscellaneous text and callouts with associated leaders	0	V	V	V
NA	E-ANNO-REFR	E-----RFP-	Reference files (AutoCAD users only, see Chapter 4)	NA	NA	NA	NA
Floor Information							
8	E-FLOR-IDEN	E-FLORIDM-	Room name, space identification text (copied from Architectural - Floor Plan model file)	0	0.25	G/3	G/2
9	E-FLOR-NUMB	E-FLORNUM-	Room/space identification number and symbol (copied from Architectural - Floor Plan model file)	0	0.25	G/3	G/2
Electrical Equipment							
10	E-POWR-PANL	E-POWRPAM-	Panelboards, switchboards, MCC, unit substations	0	0.50	C/4	C/7
Junction Boxes							
14	E-POWR-JBOX	E-POWRJBM-	Junction boxes	0	0.50	83	42
Switches							
16	E-POWR-SWCH	E-POWRSWM-	Disconnect switches, motor starters, contactors, etc	0	0.50	163	41
Power							
18	E-POWR-BUSW	E-POWRBUM-	Busways and wireways	0, BUSWAY, WIREWY	0.50	203	45
19	E-POWR-CABL	E-POWRCAM-	Cable trays	0	0.50	203	45
20	E-POWR-CLNG	E-POWRCLM-	Ceiling outlets (receptacles and switches)	0	0.50	83	42
21	E-POWR-FEED	E-POWRFEM-	Feeders	0	0.50	203	45
24	E-POWR-URAC	E-POWRURM-	Underfloor raceways	3	0.50	203	45
25	E-POWR-WALL	E-POWRWAM-	Wall/floor outlets (receptacles and switches)	0	0.50	83	42
Motors/Generators							
27	E-POWR-MOTR	E-POWRMOM-	Motors and utilization equipment	0	0.50	C/4	C/7
28	E-POWR-GENR	E-POWRGEM-	Generators and auxiliary equipment	0	0.50	C/4	C/7
Circuit Lines							
47	E-POWR-CIRC	E-POWRCIM-	Power circuits (including crosslines and homeruns)	V	0.50	83	42
48	E-POWR-CIRC-NUMB	E-POWRCNM-	Power circuit numbers (e.g., panel/circuit number, wire/conduit size)	0	0.35	Y/2	Y/4
Demolition (used only in creating Existing/Demolition model files)							
56	E-STAT-DEMO-PHS1	E-----M-D----1	Demolition - phase 1	0	0.50	203	45
57	E-STAT-DEMO-PHS2	E-----M-D----2	Demolition - phase 2	0	0.50	83	42
58	E-STAT-DEMO-PHS3	E-----M-D----3	Demolition - phase 3	0	0.50	163	41
Other Discipline Information							
60	E-DISC-INFO	E-DISCINM-	Clearances and working space information (NEC code, etc.)	0	0.25	G/3	G/2

Note: V = Varies, NA = Not Applicable

Discipline: Electrical

Model File Type: Special Systems Plan

Level #	Level/Layer Naming		Level/Layer Description	Graphics			
	AIA Format	ISO Format		Line Style	Line Width (mm)	AutoCAD Line Color/#	MicroStation Line Color/#
General Information							
1	E-ANNO-DIMS	E-----DIP-	Witness/extension lines, dimension terminators, dimension text	0	V	V	V
2	E-ANNO-KEYN	E-----KEP-	Reference keynotes with associated leaders	0	V	V	V
3	E-ANNO-NPLT	E-----NPP-	Non-plotting graphic information	V	0.18	B/5	B/1
4	E-ANNO-PATT	E-----PAP-	Miscellaneous patterning and hatching	0	0.18	Gr/8	Gr/9
5	E-ANNO-NOTE	E-----NOP-	General notes and general remarks	0	0.35	Y/2	Y/4
6	E-ANNO-SYMB	E-----SYP-	Miscellaneous symbols	V	0.35	M/6	M/5
7	E-ANNO-TEXT	E-----TEP-	Miscellaneous text and callouts with associated leaders	0	V	V	V
NA	E-ANNO-REFR	E-----RFP-	Reference files (AutoCAD users only, see Chapter 4)	NA	NA	NA	NA
Floor Information							
8	E-FLOR-IDEN	E-FLORIDM-	Room name, space identification text (copied from Architectural - Floor Plan model file)	0	0.25	G/3	G/2
9	E-FLOR-NUMB	E-FLORNUM-	Room/space identification number and symbol (copied from Architectural - Floor Plan model file)	0	0.25	G/3	G/2
Electrical Equipment							
10	E-SPCL-PANL	E-SPCLPAM-	Panelboards, backing boards, patch panel rack	0	0.50	C/4	C/7
Junction Boxes							
14	E-SPCL-JBOX	E-SPCLJBM-	Junction boxes	0	0.50	83	42
Bell System							
16	E-BELL-IDEN	E-BELLIDM-	Identifier tags, symbol modifier, and text	0	0.35	Y/2	Y/4
17	E-BELL-SYMB	E-BELLSYM-	Bell system symbols	0	0.50	203	45
Central Dictation System							
18	E-DICT-IDEN	E-DICTIDM-	Identifier tags, symbol modifier, and text	0	0.35	Y/2	Y/4
19	E-DICT-SYMB	E-DICTSYM-	Central dictation system symbols	0	0.50	203	45
Clock System							
20	E-CLOK-IDEN	E-CLOKIDM-	Identifier tags, symbol modifier, and text	0	0.35	Y/2	Y/4
21	E-CLOK-SYMB	E-CLOKSYM-	Clock system symbols	0	0.50	203	45
Miscellaneous Alarm System							
22	E-ALRM-IDEN	E-ALRMIDM-	Identifier tags, symbol modifier, and text	0	0.35	Y/2	Y/4
23	E-ALRM-SYMB	E-ALRMSYM-	Miscellaneous alarm system symbols	0	0.50	203	45
Nurse Call/Paging Systems							
24	E-NURS-IDEN	E-NURSIDM-	Identifier tags, symbol modifier, and text	0	0.35	Y/2	Y/4
25	E-NURS-SYMB	E-NURSSYM-	Nurse call/paging system symbols	0	0.50	203	45
Sound System							
26	E-SOUN-IDEN	E-SOUNIDM-	Identifier tags, symbol modifier, and text	0	0.35	Y/2	Y/4
27	E-SOUN-SYMB	E-SOUNSYM-	Sound system symbols	0	0.50	203	45
Cable TV System							
28	E-CATV-IDEN	E-CATVIDM-	Identifier tags, symbol modifier, and text	0	0.35	Y/2	Y/4
29	E-CATV-SYMB	E-CATVSYM-	Cable television system symbols	0, CABLTV	0.50	203	45
Closed-Circuit Television System							
30	E-CCTV-IDEN	E-CCTVIDM-	Identifier tags, symbol modifier, and text	0	0.35	Y/2	Y/4
31	E-CCTV-SYMB	E-CCTVSYM-	Closed-circuit television system symbols	0	0.50	203	45
TV Antenna System							
32	E-TVAN-IDEN	E-TVANIDM-	Identifier tags, symbol modifier, and text	0	0.35	Y/2	Y/4
33	E-TVAN-SYMB	E-TVANSYM-	TV antenna system symbols	0	0.50	203	45
Intercom/Public Address System							
34	E-INTC-IDEN	E-INTCIDM-	Identifier tags, symbol modifier, and text	0	0.35	Y/2	Y/4
35	E-INTC-SYMB	E-INTCSYM-	Intercom/PA system symbols	0	0.50	203	45
Energy Monitoring Control Systems							
36	E-EMCS-IDEN	E-EMCSIDM-	Identifier tags, symbol modifier, and text	0	0.35	Y/2	Y/4
37	E-EMCS-SYMB	E-EMCSSYM-	Energy monitoring control system symbols	0	0.50	203	45
Security System							
38	E-SERT-IDEN	E-SERTIDM-	Identifier tags, symbol modifier, and text	0	0.35	Y/2	Y/4
39	E-SERT-ACCS	E-SERTACM-	Access control system symbols	0	0.50	23	46
40	E-SERT-UNDR	E-SERTUNM-	Buried sensors	0	0.50	23	46
41	E-SERT-CLNG	E-SERTCLM-	Ceiling mounted sensors	0	0.50	23	46
42	E-SERT-FLOR	E-SERTFLM-	Floor mounted sensors	0	0.50	23	46
43	E-SERT-WALL	E-SERTWAM-	Wall mounted sensors	0	0.50	23	46

Discipline: Electrical

Model File Type: Special Systems Plan

Cable System							
50	E-CABL-COAX	E-COMMCOM-	Coax cable	2	0.50	83	42
51	E-CABL-FIBR	E-COMMFIM-	Fiber optics cable	FIBOPT	0.50	83	42
52	E-CABL-IDEN	E-COMMIDM-	Cable identifiers	0	0.35	Y/2	Y/4
53	E-CABL-MULT	E-COMMMUM-	Multi-conductor cable	V	0.50	83	42
54	E-CABL-TRAY	E-COMMTRM-	Cable trays and wireways	0	0.50	203	45
Demolition (used only in creating Existing/Demolition model files)							
56	E-STAT-DEMO-PHS1	E-----M-D----1	Demolition - phase 1	0	0.50	203	45
57	E-STAT-DEMO-PHS2	E-----M-D----2	Demolition - phase 2	0	0.50	83	42
58	E-STAT-DEMO-PHS3	E-----M-D----3	Demolition - phase 3	0	0.50	163	41
Other Discipline Information							
60	E-DISC-INFO	E-DISCINM-	Clearances and working space information (NEC code, etc.)	0	0.25	G/3	G/2

Note: V = Varies, NA = Not Applicable

Discipline: Electrical

Model File Type: Grounding System Plan

Level #	Level/Layer Naming		Level/Layer Description	Graphics			
	AIA Format	ISO Format		Line Style	Line Width (mm)	AutoCAD Line Color#	MicroStation Line Color#
General Information							
1	E-ANNO-DIMS	E----DIP-	Witness/extension lines, dimension terminators, dimension text	0	V	V	V
2	E-ANNO-KEYN	E-----KEP-	Reference keynotes with associated leaders	0	V	V	V
3	E-ANNO-NPLT	E-----NPP-	Non-plotting graphic information	V	0.18	B/5	B/1
4	E-ANNO-PATT	E-----PAP-	Miscellaneous patterning and hatching	0	0.18	Gr/8	Gr/9
5	E-ANNO-NOTE	E-----NOP-	General notes and general remarks	0	0.35	Y/2	Y/4
6	E-ANNO-SYMB	E-----SYP-	Miscellaneous symbols	V	0.35	M/6	M/5
7	E-ANNO-TEXT	E-----TEP-	Miscellaneous text and callouts with associated leaders	0	V	V	V
NA	E-ANNO-REFR	E-----RFP-	Reference files (AutoCAD users only, see Chapter 4)	NA	NA	NA	NA
Ground System							
33	E-GRND-CIRC	E-GRNDCIM-	Circuits	0	0.50	C/4	C/7
34	E-GRND-DIAG	E-GRNDDIM-	Ground system diagram	0	0.50	163	41
35	E-GRND-EQUI	E-GRNDEQM-	Equipotential ground system	0	0.50	83	42
36	E-GRND-REFR	E-GRNDREM-	Reference ground system	0	0.50	23	46
Lightning Protection System							
38	E-LTNG-COND	E-LTNGCOM-	Lightning protection conductors	0	0.50	203	45
39	E-LTNG-TERM	E-LTNGTEM-	Lightning protection terminals	0	0.50	203	45
Demolition (used only in creating Existing/Demolition model files)							
56	E-STAT-DEMO-PHS1	E-----M-D----1	Demolition - phase 1	0	0.50	203	45
57	E-STAT-DEMO-PHS2	E-----M-D----2	Demolition - phase 2	0	0.50	83	42
58	E-STAT-DEMO-PHS3	E-----M-D----3	Demolition - phase 3	0	0.50	163	41

Note: V = Varies, NA = Not Applicable

Discipline: Electrical

Model File Type: Electrical Utilities Plan

Level #	Level/Layer Naming		Level/Layer Description	Graphics			
	AIA Format	ISO Format		Line Style	Line Width (mm)	AutoCAD Line Color/#	MicroStation Line Color/#
General Information							
1	E-ANNO-DIMS	E-----DIP-	Witness/extension lines, dimension terminators, dimension text	0	V	V	V
2	E-ANNO-KEYN	E-----KEP-	Reference keynotes with associated leaders	0	V	V	V
3	E-ANNO-NPLT	E-----NPP-	Non-plotting graphic information	V	0.18	B/5	B/1
4	E-ANNO-PATT	E-----PAP-	Miscellaneous patterning and hatching	0	0.18	Gr/8	Gr/9
5	E-ANNO-NOTE	E-----NOP-	General notes and general remarks	0	0.35	Y/2	Y/4
6	E-ANNO-SYMB	E-----SYP-	Miscellaneous symbols	V	0.35	M/6	M/5
7	E-ANNO-TEXT	E-----TEP-	Miscellaneous text and callouts with associated leaders	0	V	V	V
NA	E-ANNO-REFR	E-----RFP-	Reference files (AutoCAD users only, see Chapter 4)	NA	NA	NA	NA
Primary Electrical Cables							
11	E-PRIM-OVHD	E-PRIMOVM-	Overhead electrical utility lines	EPARN	0.50	C/4	C/7
12	E-PRIM-OVHD-IDEN	E-PRIMOIM-	Identifier tags, symbol modifier, and text	0	0.35	Y/2	Y/4
13	E-PRIM-UNDR	E-PRIMUMM-	Underground electrical utility lines	EPUGN	0.50	C/4	C/7
14	E-PRIM-UNDR-IDEN	E-PRIMUMI-	Identifier tags, symbol modifier, and text	0	0.35	Y/2	Y/4
Secondary Electrical Cables							
15	E-SECD-OVHD	E-SECDOVM-	Overhead electrical utility lines	ESARN	0.50	163	41
16	E-SECD-OVHD-IDEN	E-SECDOIM-	Identifier tags, symbol modifier, and text	0	0.35	Y/2	Y/4
17	E-SECD-UNDR	E-SECUNMM-	Underground electrical utility lines	ESUGN	0.50	163	41
18	E-SECD-UNDR-IDEN	E-SECUNIM-	Identifier tags, symbol modifier, and text	0	0.35	Y/2	Y/4
Transformers							
19	E-TRAN-PADM	E-TRANPAM-	Pad mounted transformers	0	0.50	23	46
20	E-TRAN-PADM-IDEN	E-TRANPDM-	Identifier tags, symbol modifier, and text	0	0.35	Y/2	Y/4
21	E-TRAN-POLE	E-TRANPOM-	Pole mounted transformers	0	0.50	23	46
22	E-TRAN-POLE-IDEN	E-TRANPIM-	Identifier tags, symbol modifier, and text	0	0.35	Y/2	Y/4
Electrical Support Equipment							
23	E-ELEC-JBOX	E-ELECBJM-	Junction boxes, pull boxes, manholes, handholes, pedestals, splices	0	0.50	23	46
24	E-ELEC-DEVC	E-ELECDM-	Capacitors, voltage regulators, motors, buses, generators, meters, grounds, and markers	0	0.50	23	46
25	E-ELEC-SWCH	E-ELECSWM-	Fuse cutouts, pole mounted switches, circuit breakers, gang operated disconnects, reclosers, cubicle switches	0	0.50	23	46
26	E-ELEC-SUBS	E-ELECSUM-	Other substation equipment	0	0.50	23	46
Lights							
31	E-LITE-EXTR	E-LITEFXM-	Exterior lights	0	0.50	203	45
32	E-LITE-EXTR-IDEN	E-LITEFIM-	Identifier tags, symbol modifier, and text	0	0.35	Y/2	Y/4
Utility Poles							
33	E-POLE-UTIL	E-POLEUTM-	Utility poles	0	0.50	203	45
34	E-POLE-IDEN	E-POLEUIM-	Utility pole identifier tags, symbol modifier, and text	0	0.35	Y/2	Y/4
35	E-POLE-GUYS	E-POLEGYM-	Guying equipment	0	0.50	203	45
36	E-POLE-GUYS-IDEN	E-POLEGIM-	Guying equipment identifier tags, symbol modifiers, and text	0	0.35	Y/2	Y/4
Underground Ductbanks (to be used when multiple systems are in one ductbank system)							
37	E-DUCT-MULT	E-DUCTMUM-	Ductbank	EUDUCN	0.50	83	42
38	E-DUCT-MULT-IDEN	E-DUCTMIM-	Identifier tags, symbol modifier and text	0	0.35	Y/2	Y/4
Cathodic Protection System							
40	E-CATH-ANOD	E-CATHANM-	Sacrificial anode system	0	0.50	83	42
41	E-CATH-CURR	E-CATHCUM-	Impress current system	0	0.50	83	42
42	E-CATH-TEST	E-CATHTEM-	Test stations	0	0.50	83	42
43	E-CATH-IDEN	E-CATHIDM-	Identifier tags, symbol modifier, and text	0	0.35	Y/2	Y/4
Special Systems							
45	E-SPCL-TRAF	E-SPCLTRM-	Traffic signal system	0	0.50	203	45
46	E-SPCL-TRAF-IDEN	E-SPCLTIM-	Traffic signal identifier tags, symbol modifier, and text	0	0.35	Y/2	Y/4
47	E-SPCL-SYST	E-SPCLSYM-	Special systems (UMCS, EMCS, CATV, etc.)	0	0.50	203	45
48	E-SPCL-IDEN	E-SPCLIDM-	Special systems (UMCS, EMCS, CATV, etc.) identifier tags, symbol modifier, and text	0	0.35	Y/2	Y/4

Discipline: Electrical

Model File Type: Electrical Utilities Plan

Demolition (used only in creating Existing/Demolition model files)						
56	E-STAT-DEMO-PHS1	E-----M-D----1	Demolition - phase 1	0	0.50	203 45
57	E-STAT-DEMO-PHS2	E-----M-D----2	Demolition - phase 2	0	0.50	83 42
58	E-STAT-DEMO-PHS3	E-----M-D----3	Demolition - phase 3	0	0.50	163 41
Other Discipline Information						
60	E-DISC-INFO	E-DISCINM-	Clearances and working space information (NEC code, etc.)	0	0.25	G/3 G/2

Note: V = Varies, NA = Not Applicable

Discipline: Electrical

Model File Type: Exterior Communication Systems Plan

Level #	Level/Layer Naming		Level/Layer Description	Graphics			
	AIA Format	ISO Format		Line Style	Line Width (mm)	AutoCAD Line Color/#	MicroStation Line Color/#
General Information							
1	E-ANNO-DIMS	E-----DIP-	Witness/extension lines, dimension terminators, dimension text	0	V	V	V
2	E-ANNO-KEYN	E-----KEP-	Reference keynotes with associated leaders	0	V	V	V
3	E-ANNO-NPLT	E-----NPP-	Non-plotting graphic information	V	0.18	B/5	B/1
4	E-ANNO-PATT	E-----PAP-	Miscellaneous patterning and hatching	0	0.18	Gr/8	Gr/9
5	E-ANNO-NOTE	E-----NOP-	General notes and general remarks	0	0.35	Y/2	Y/4
6	E-ANNO-SYMB	E-----SYP-	Miscellaneous symbols	V	0.35	M/6	M/5
7	E-ANNO-TEXT	E-----TEP-	Miscellaneous text and callouts with associated leaders	0	V	V	V
NA	E-ANNO-REFR	E-----RFP-	Reference files (AutoCAD users only, see Chapter 4)	NA	NA	NA	NA
Communications Cables (Copper and Fiber Optic)							
11	E-COMM-OVHD	E-COMMOVM-	Overhead communications/telephone lines	COMARN	0.50	C/4	C/7
12	E-COMM-OVHD-IDENT	E-COMMOIM-	Identifier tags, symbol modifier and text	0	0.35	Y/2	Y/4
13	E-COMM-UNDR	E-COMMUM-	Underground communications/telephone lines	COMUGN	0.50	C/4	C/7
14	E-COMM-UNDR-IDENT	E-COMMUIM-	Identifier tags, symbol modifier and text	0	0.35	Y/2	Y/4
Communications Support Equipment							
23	E-COMM-JBOX	E-COMMJBM-	Communication junction boxes, pull boxes, manholes, handholes, pedestals, splices	0	0.50	23	46
26	E-COMM-EQPM	E-COMMEQM-	Other communications distribution equipment	0	0.50	23	46
Utility Poles (Use only if different from Existing Electrical Utilities Plan poles)							
33	E-POLE-UTIL	E-POLEUTM-	Poles	0	0.50	203	45
34	E-POLE-IDENT	E-POLEIDM-	Identifier tags, symbol modifier, and text	0	0.35	Y/2	Y/4
35	E-POLE-GUYS	E-POLEGYM-	Guying equipment	0	0.50	203	45
36	E-POLE-GUYS-IDENT	E-POLEGIM-	Guying equipment identifier tags, symbol modifiers, and text	0	0.35	Y/2	Y/4
Underground Ductbanks (to be used when multiple systems are in one ductbank system)							
37	E-DUCT-MULT	E-DUCTMUM-	Ductbank	EUDUCN	0.50	83	42
38	E-DUCT-MULT-IDENT	E-DUCTMIM-	Identifier tags, symbol modifier and text	0	0.35	Y/2	Y/4
Demolition (used only in creating Existing/Demolition model files)							
56	E-STAT-DEMO-PHS1	E-----M-D----1	Demolition - phase 1	0	0.50	203	45
57	E-STAT-DEMO-PHS2	E-----M-D----2	Demolition - phase 2	0	0.50	83	42
58	E-STAT-DEMO-PHS3	E-----M-D----3	Demolition - phase 3	0	0.50	163	41
Other Discipline Information							
60	E-DISC-INFO	E-DISCINM-	Clearances and working space information (NEC code, etc.)	0	0.25	G/3	G/2

Note: V = Varies, NA = Not Applicable

Discipline: Electrical

Model File Type: Airfield Lighting Plan

Level #	Level/Layer Naming		Level/Layer Description	Graphics			
	AIA Format	ISO Format		Line Style	Line Width (mm)	AutoCAD Line Color/#	MicroStation Line Color/#
General Information							
1	E-ANNO-DIMS	E-----DIP-	Witness/extension lines, dimension terminators, dimension text	0	V	V	V
2	E-ANNO-KEYN	E-----KEP-	Reference keynotes with associated leaders	0	V	V	V
3	E-ANNO-NPLT	E-----NPP-	Non-plotting graphic information	V	0.18	B/5	B/1
4	E-ANNO-PATT	E-----PAP-	Miscellaneous patterning and hatching	0	0.18	Gr/8	Gr/9
5	E-ANNO-NOTE	E-----NOP-	General notes and general remarks	0	0.35	Y/2	Y/4
6	E-ANNO-SYMB	E-----SYP-	Miscellaneous symbols	V	0.35	M/6	M/5
7	E-ANNO-TEXT	E-----TEP-	Miscellaneous text and callouts with associated leaders	0	V	V	V
NA	E-ANNO-REFR	E-----RFP-	Reference files (AutoCAD users only, see Chapter 4)	NA	NA	NA	NA
Airfield Lighting Circuits							
11	E-CIRC-SERS	E-CIRCSEM-	Series circuits	0	0.50	203	45
12	E-CIRC-MULT	E-CIRCMUM-	Multiple circuits	0	0.50	23	46
13	E-CIRC-CTRL	E-CIRCCTM-	Control and monitoring circuits	0	0.50	163	41
15	E-CIRC-IDEN	E-CIRCIDM-	Identifier tags, symbol modifier, and tex	0	0.35	Y/2	Y/4
Devices							
20	E-AIRF-DEVC	E-AIRFDEM-	Capacitors, voltage regulators, motors, buses, generators, meters, grounds, and markers	0	0.50	23	46
Junction Boxes							
23	E-AIRF-JBOX	E-AIRFJBM-	Junction boxes, pull boxes, manholes, handholes, pedestals, splice:	0	0.50	23	46
Lights							
25	E-LITE-OBST	E-LITEOBM-	Obstruction lights	0	0.50	203	45
26	E-LITE-DIST	E-LITEDIM-	Distance and arresting gear markers	0	0.50	203	45
28	E-LITE-APPR	E-LITEAPM-	Approach lights	0	0.50	203	45
29	E-LITE-THRS	E-LITETHM-	Threshold lights	0	0.50	203	45
30	E-LITE-RUNW	E-LITERUM-	Runway lights	0	0.50	203	45
31	E-LITE-TAXI	E-LITETAM-	Taxiway lights	0	0.50	203	45
32	E-LITE-LANE	E-LITELAM-	Hoverlane, taxilane, and helipad lights	0	0.50	203	45
33	E-LITE-SIGN	E-LITESIM-	Taxiway guidance signs	0	0.50	203	45
Ductbank							
37	E-AIRF-DUCT	E-AIRFDUM-	Ductbanks	EUDUCN	0.50	83	42
Beacons							
42	E-BCNS-IDEN	E-BCNSIDM-	Identifier tags, symbol modifier, and text	0	0.35	Y/2	Y/4
43	E-BCNS-STRB	E-BCNSSTM-	Strobe beacons	0	0.50	203	45
44	E-BCNS-MISC	E-BCNSMIM-	Miscellaneous nav aids - windcones and beacons	0	0.50	203	45
Demolition (used only in creating Existing/Demolition model files)							
56	E-STAT-DEMO-PHS1	E-----M-D----1	Demolition - phase 1	0	0.50	203	45
57	E-STAT-DEMO-PHS2	E-----M-D----2	Demolition - phase 2	0	0.50	83	42
58	E-STAT-DEMO-PHS3	E-----M-D----3	Demolition - phase 3	0	0.50	163	41
Other Discipline Information							
60	E-DISC-INFO	E-DISCINM-	Clearances and working space information (NEC code, etc.,	0	0.25	G/3	G/2

Note: V = Varies, NA = Not Applicable

Discipline: Electrical
Model File Type: Details

Level #	Level/Layer Naming		Level/Layer Description	Graphics			
	AIA Format	ISO Format		Line Style	Line Width (mm)	AutoCAD Line Color/#	MicroStation Line Color/#
General Information							
1	E-ANNO-DIMS	E-----DIP-	Witness/extension lines, dimension terminators, dimension text	0	V	V	V
2	E-ANNO-KEYN	E-----KEP-	Keynotes with associated terminators	0	V	V	V
3	E-ANNO-NPLT	E-----NPP-	Non-plotting graphic information	V	0.18	B/5	B/1
4	E-ANNO-PATT	E-----PAP-	Miscellaneous patterning and hatching	0	0.18	Gr/8	Gr/9
5	E-ANNO-NOTE	E-----NOP-	General notes and general remarks	0	0.35	Y/2	Y/4
6	E-ANNO-SYMB	E-----SYP-	Reference bubbles, matchlines and breaklines	0	0.35	M/6	M/5
7	E-ANNO-TEXT	E-----TEP-	Detail title text, text and associated leaders, notes	0	0.35	Y/2	Y/4
Detail Information							
11	E-DETL-GRPH	E-DETLGRM-	Graphics, gridlines, non-text items	V	V	V	V
12	E-DETL-METR	E-DETLMEM-	Metric-specific dimensions and notes	0	0.35	Y/2	Y/4
13	E-DETL-INPD	E-DETLINM-	Inch-pound-specific dimensions and notes	0	0.35	Y/2	Y/4
Other Discipline Information							
60	E-DISC-INFO	E-DISCINM-	Information and notes for other disciplines	V	V	V	V

Note: V = Varies

Discipline: Electrical

Model File Type: Riser/One-Line Diagrams

Level #	Level/Layer Naming		Level/Layer Description	Graphics			
	AIA Format	ISO Format		Line Style	Line Width (mm)	AutoCAD Line Color#	MicroStation Line Color#
General Information							
1	E-ANNO-DIMS	E-----DIP-	Witness/extension lines, dimension terminators, dimension text	0	V	V	V
2	E-ANNO-KEYN	E-----KEP-	Keynotes with associated terminators	0	V	V	V
3	E-ANNO-NPLT	E-----NPP-	Non-plotting graphic information	V	0.18	B/5	B/1
4	E-ANNO-PATT	E-----PAP-	Miscellaneous patterning and hatching	0	0.18	Gr/8	Gr/9
5	E-ANNO-NOTE	E-----NOP-	General notes and general remarks	0	0.35	Y/2	Y/4
6	E-ANNO-SYMB	E-----SYP-	Miscellaneous symbols	0	0.35	M/6	M/5
7	E-ANNO-TEXT	E-----TEP-	Miscellaneous text and callouts with associated leaders	0	0.35	Y/2	Y/4
Diagram Information							
11	E-DIAG-GRPH	E-DIAGGRM-	Graphics, gridlines, non-text items	V	V	V	V
12	E-DIAG-METR	E-DIAGMEM-	Metric-specific dimensions and notes	0	0.35	Y/2	Y/4
13	E-DIAG-INPD	E-DIAGINM-	Inch-pound-specific dimensions and notes	0	0.35	Y/2	Y/4
14	E-DIAG-IDEN	E-DIAGIDM-	Identifier tags, symbol modifier and text	0	0.35	Y/2	Y/4
Other Discipline Information							
60	E-DISC-INFO	E-DISCINM-	Information and notes for other disciplines	V	V	V	V

Note: V = Varies

Discipline: Telecommunications
Model File Type: Telephone/Data Plan

Level #	Level/Layer Naming		Level/Layer Description	Graphics			
	AIA Format	ISO Format		Line Style	Line Width (mm)	AutoCAD Line Color/#	MicroStation Line Color/#
General Information							
1	T-ANNO-DIMS	T-----DIP-	Witness/extension lines, dimension terminators, dimension text	0	V	V	V
2	T-ANNO-KEYN	T-----KEP-	Reference keynotes with associated leaders	0	V	V	V
3	T-ANNO-NPLT	T-----NPP-	Non-plotting graphic information	V	0.18	B/5	B/1
4	T-ANNO-PATT	T-----PAP-	Miscellaneous patterning and hatching	0	0.18	Gr/8	Gr/9
5	T-ANNO-NOTE	T-----NOP-	General notes and general remarks	0	0.35	Y/2	Y/4
6	T-ANNO-SYMB	T-----SYP-	Miscellaneous symbols	V	0.35	M/6	M/5
7	T-ANNO-TEXT	T-----TEP-	Miscellaneous text and callouts with associated leaders	0	V	V	V
NA	T-ANNO-REFR	T-----RFP-	Reference files (AutoCAD users only, see Chapter 4)	NA	NA	NA	NA
Floor Information							
8	T-FLOR-IDEN	T-FLORIDM-	Room name, space identification text (copied from Architectural - Floor Plan model file)	0	0.25	G/3	G/2
9	T-FLOR-NUMB	T-FLORNUM-	Room/space identification number and symbol (copied from Architectural - Floor Plan model file)	0	0.25	G/3	G/2
Telecommunications Equipment							
10	T-EQPM-COPP	T-EQPMCOM-	Distribution equipment for copper	0	0.50	C/4	C/7
11	T-EQPM-FIBR	T-EQPMFIM-	Distribution equipment for fiber optic	0	0.50	C/4	C/7
12	T-EQPM-RELA	T-EQPMREM-	Relays, resistors, capacitors, and inductors	0	0.50	C/4	C/7
13	T-EQPM-OTHR	T-EQPMOTM-	Other telecommunications equipment	0	0.50	C/4	C/7
15	T-EQPM-COMB	T-EQPMCMM-	Distribution equipment for both copper and fiber optic:	0	0.50	C/4	C/7
Junction Boxes							
14	T-COMM-JBOX	T-COMMJBM-	Junction boxes	0	0.50	83	42
Jacks							
28	T-JACK-IDEN	T-JACKIDM-	Identifier tags, symbol modifier, and text	0	0.35	Y/2	Y/4
29	T-JACK-PHON	T-JACKPHM-	Telephone jacks	0	0.50	203	45
30	T-JACK-DATA	T-JACKDAM-	Data/LAN jacks	0	0.50	203	45
31	T-JACK-COMB	T-JACKCOM-	Combination telephone and data/LAN jacks	0	0.50	203	45
Cable System							
50	T-CABL-COAX	T-CABLCOM-	Coax cable	2	0.50	83	42
51	T-CABL-FIBR	T-CABLFIM-	Fiber optics cable	FIBOPT	0.50	83	42
52	T-CABL-IDEN	T-CABLIDM-	Cable identifiers	0	0.35	Y/2	Y/4
53	T-CABL-MULT	T-CABLNUM-	Multi-conductor cable	V	0.50	83	42
54	T-CABL-TRAY	T-CABLTRM-	Cable trays and wireways	0	0.50	203	45
Demolition (used only in creating Existing/Demolition model files)							
56	T-STAT-DEMO-PHS1	T-----M-D----1	Demolition - phase 1	0	0.50	203	45
57	T-STAT-DEMO-PHS2	T-----M-D----2	Demolition - phase 2	0	0.50	83	42
58	T-STAT-DEMO-PHS3	T-----M-D----3	Demolition - phase 3	0	0.50	163	41
Other Discipline Information							
60	T-DISC-INFO	T-DISCINM-	Information and notes for other disciplines	V	V	V	V

Note: V = Varies, NA = Not Applicable

Discipline: Telecommunications

Model File Type: Riser Diagrams

Level #	Level/Layer Naming		Level/Layer Description	Graphics			
	AIA Format	ISO Format		Line Style	Line Width (mm)	AutoCAD Line Color/#	MicroStation Line Color/#
General Information							
1	T-ANNO-DIMS	T-----DIP-	Witness/extension lines, dimension terminators, dimension text	0	V	V	V
2	T-ANNO-KEYN	T-----KEP-	Reference keynotes with associated leaders	0	V	V	V
3	T-ANNO-NPLT	T-----NPP-	Non-plotting graphic information	V	0.18	B/5	B/1
4	T-ANNO-PATT	T-----PAP-	Miscellaneous patterning and hatching	0	0.18	Gr/8	Gr/9
5	T-ANNO-NOTE	T-----NOP-	General notes and general remarks	0	0.35	Y/2	Y/4
6	T-ANNO-SYMB	T-----SYP-	Miscellaneous symbols	V	0.35	M/6	M/5
7	T-ANNO-TEXT	T-----TEP-	Miscellaneous text and callouts with associated leaders	0	V	V	V
NA	T-ANNO-REFR	T-----RFP-	Reference files (AutoCAD users only, see Chapter 4)	NA	NA	NA	NA
Diagram Information							
11	T-DIAG-GRPH	T-DIAGGRM-	Graphics, gridlines, non-text items	V	V	V	V
12	T-DIAG-METR	T-DIAGMEM-	Metric-specific dimensions and notes	0	0.35	Y/2	Y/4
13	T-DIAG-INPD	T-DIAGINM-	Inch-pound-specific dimensions and notes	0	0.35	Y/2	Y/4
14	T-DIAG-IDEN	T-DIAGIDM-	Identifier tags, symbol modifier and text	0	0.35	Y/2	Y/4
Other Discipline Information							
60	T-DISC-INFO	T-DISCINM-	Information and notes for other disciplines	V	V	V	V

Note: V = Varies, NA = Not Applicable

Appendix B

Sheet File Level/Layer Assignment Tables

This appendix provides the sheet file level/layer assignment tables:

General	B3
Hazardous Materials	B4
Survey/Mapping	B5
Geotechnical	B6
Civil.....	B7
Landscape	B8
Structural	B9
Architectural	B10
Interiors.....	B11
Fire Protection	B12
Plumbing	B13
Mechanical	B14
Electrical.....	B15
Telecommunications.....	B16

Discipline: General

Level #	Level/Layer Naming		Level/Layer Description	Graphics			
	AIA Format	ISO Format		Line Style	Line Width (mm)	AutoCAD Line Color/#	MicroStation Line Color/#
General Information							
2	G-ANNO-KEYN	G-----KEP-	Sheet-specific reference keynotes with associated leaders	0	V	V	V
3	G-ANNO-LEGN	G-----LEP-	Legends and schedules	0	V	V	V
4	G-ANNO-PATT	G-----PAP-	Sheet-specific patterning and hatching (e.g., keyplan patterning)	0	0.18	Gr/8	Gr/9
5	G-ANNO-NOTE	G-----NOP-	Sheet-specific notes and general remarks	0	0.35	Y/2	Y/4
6	G-ANNO-SYMB	G-----SYP-	Sheet-specific symbols (e.g., scales, north arrow, section cuts, detail bubbles, etc.)	V	0.35	M/6	M/5
7	G-ANNO-TEXT	G-----TEP-	Sheet-specific text and callouts with associated leaders (e.g., title block text, legend and schedule text)	0	V	V	V
62	G-ANNO-REDL	G-----REP-	Redlines	0	0.25	R/1	R/3
63	G-ANNO-REVS	G-----RVP-	Revisions	0	0.50	C/4	C/7
NA	G-ANNO-REFR	G-----RFP-	Referenced model files (AutoCAD users only, see Chapter 4)	NA	NA	NA	NA

Note: V = Varies, NA = Not Applicable

Discipline: Hazardous Materials

Level #	Level/Layer Naming		Level/Layer Description	Graphics			
	AIA Format	ISO Format		Line Style	Line Width (mm)	AutoCAD Line Color/#	MicroStation Line Color/#
General Information							
1	H-ANNO-DIMS	H-----DIP-	Sheet-specific dimensions (includes witness/extension lines, dimension terminators, dimension text)	0	V	V	V
2	H-ANNO-KEYN	H-----KEP-	Sheet-specific reference keynotes with associated leaders	0	V	V	V
3	H-ANNO-LEGN	H-----LEP-	Legends and schedules	0	V	V	V
4	H-ANNO-PATT	H-----PAP-	Sheet-specific patterning and hatching (e.g., keyplan patterning)	0	0.18	Gr/8	Gr/9
5	H-ANNO-NOTE	H-----NOP-	Sheet-specific notes and general remarks	0	0.35	Y/2	Y/4
6	H-ANNO-SYMB	H-----SYP-	Sheet-specific symbols (e.g., scales, north arrow, section cuts, detail bubbles, etc.)	V	0.35	M/6	M/5
7	H-ANNO-TEXT	H-----TEP-	Sheet-specific text and callouts with associated leaders (e.g., title block text, legend and schedule text)	0	V	V	V
62	H-ANNO-REDL	H-----REP-	Redlines	0	0.25	R/1	R/3
63	H-ANNO-REVS	H-----RVP-	Revisions	0	0.50	C/4	C/7
NA	H-ANNO-REFR	H-----RFP-	Referenced model files (AutoCAD users only, see Chapter 4)	NA	NA	NA	NA

Note: V = Varies, NA = Not Applicable

Discipline: Survey/Mapping

Level #	Level/Layer Naming		Level/Layer Description	Graphics			
	AIA Format	ISO Format		Line Style	Line Width (mm)	AutoCAD Line Color/#	MicroStation Line Color/#
General Information							
1	V-ANNO-DIMS	V-----DIP-	Sheet-specific dimensions (includes witness/extension lines, dimension terminators, dimension text)	0	V	V	V
2	V-ANNO-KEYN	V-----KEP-	Sheet-specific referencekeynotes with associated leaders	0	V	V	V
3	V-ANNO-LEGN	V-----LEP-	Legends and schedules	0	V	V	V
4	V-ANNO-PATT	V-----PAP-	Sheet-specific patterning and hatching (e.g., keyplan patterning)	0	0.18	Gr/8	Gr/9
5	V-ANNO-NOTE	V-----NOP-	Sheet-specific notes and general remarks	0	0.35	Y/2	Y/4
6	V-ANNO-SYMB	V-----SYP-	Sheet-specific symbols (e.g., scales, north arrow, section cuts, detail bubbles, etc.)	V	0.35	M/6	M/5
7	V-ANNO-TEXT	V-----TEP-	Sheet-specific text and callouts with associated leaders (e.g., title block text, legend and schedule text)	0	V	V	V
62	V-ANNO-REDL	V-----REP-	Redlines	0	0.25	R/1	R/3
63	V-ANNO-REVS	V-----RVP-	Revisions	0	0.50	C/4	C/7
NA	V-ANNO-REFR	V-----RFP-	Referenced model files (AutoCAD users only, see Chapter 4)	NA	NA	NA	NA

Note: V = Varies, NA = Not Applicable

Discipline: Geotechnical

Level #	Level/Layer Naming		Level/Layer Description	Graphics			
	AIA Format	ISO Format		Line Style	Line Width (mm)	AutoCAD Line Color/#	MicroStation Line Color/#
General Information							
1	B-ANNO-DIMS	B-----DIP-	Sheet-specific dimensions (includes witness/extension lines, dimension terminators, dimension text)	0	V	V	V
2	B-ANNO-KEYN	B-----KEP-	Sheet-specific reference keynotes with associated leaders	0	V	V	V
3	B-ANNO-LEGN	B-----LEP-	Legends and schedules	0	V	V	V
4	B-ANNO-PATT	B-----PAP-	Sheet-specific patterning and hatching (e.g., keyplan patterning)	0	0.18	Gr/8	Gr/9
5	B-ANNO-NOTE	B-----NOP-	Sheet-specific notes and general remarks	0	0.35	Y/2	Y/4
6	B-ANNO-SYMB	B-----SYP-	Sheet-specific symbols (e.g., scales, north arrow, section cuts, detail bubbles, etc.)	V	0.35	M/6	M/5
7	B-ANNO-TEXT	B-----TEP-	Sheet-specific text and callouts with associated leaders (e.g., title block text, legend and schedule text)	0	V	V	V
62	B-ANNO-REDL	B-----REP-	Redlines	0	0.25	R/1	R/3
63	B-ANNO-REVS	B-----RVP-	Revisions	0	0.50	C/4	C/7
NA	B-ANNO-REFR	B-----RFP-	Referenced model files (AutoCAD users only, see Chapter 4)	NA	NA	NA	NA

Note: V = Varies, NA = Not Applicable

Discipline: Civil

Level #	Level/Layer Naming		Level/Layer Description	Graphics			
	AIA Format	ISO Format		Line Style	Line Width (mm)	AutoCAD Line Color/#	MicroStation Line Color/#
General Information							
1	C-ANNO-DIMS	C-----DIP-	Sheet-specific dimensions (includes witness/extension lines, dimension terminators, dimension text)	0	V	V	V
2	C-ANNO-KEYN	C-----KEP-	Sheet-specific reference keynotes with associated leaders	0	V	V	V
3	C-ANNO-LEGN	C-----LEP-	Legends and schedules	0	V	V	V
4	C-ANNO-PATT	C-----PAP-	Sheet-specific patterning and hatching (e.g., keyplan patterning)	0	0.18	Gr/8	Gr/9
5	C-ANNO-NOTE	C-----NOP-	Sheet-specific notes and general remarks	0	0.35	Y/2	Y/4
6	C-ANNO-SYMB	C-----SYP-	Sheet-specific symbols (e.g., scales, north arrow, section cuts, detail bubbles, etc.)	V	0.35	M/6	M/5
7	C-ANNO-TEXT	C-----TEP-	Sheet-specific text and callouts with associated leaders (e.g., title block text, legend and schedule text)	0	V	V	V
62	C-ANNO-REDL	C-----REP-	Redlines	0	0.25	R/1	R/3
63	C-ANNO-REVS	C-----RVP-	Revisions	0	0.50	C/4	C/7
NA	C-ANNO-REFR	C-----RFP-	Referenced model files (AutoCAD users only, see Chapter 4)	NA	NA	NA	NA

Note: V = Varies, NA = Not Applicable

Discipline: Landscape

Level #	Level/Layer Naming		Level/Layer Description	Graphics			
	AIA Format	ISO Format		Line Style	Line Width (mm)	AutoCAD Line Color/#	MicroStation Line Color/#
General Information							
1	L-ANNO-DIMS	L-----DIP-	Sheet-specific dimensions (includes witness/extension lines, dimension terminators, dimension text)	0	V	V	V
2	L-ANNO-KEYN	L-----KEP-	Sheet-specific reference keynotes with associated leaders	0	V	V	V
3	L-ANNO-LEGN	L-----LEP-	Legends and schedules	0	V	V	V
4	L-ANNO-PATT	L-----PAP-	Sheet-specific patterning and hatching (e.g., keyplan patterning)	0	0.18	Gr/8	Gr/9
5	L-ANNO-NOTE	L-----NOP-	Sheet-specific notes and general remarks	0	0.35	Y/2	Y/4
6	L-ANNO-SYMB	L-----SYP-	Sheet-specific symbols (e.g., scales, north arrow, section cuts, detail bubbles, etc.)	V	0.35	M/6	M/5
7	L-ANNO-TEXT	L-----TEP-	Sheet-specific text and callouts with associated leaders (e.g., title block text, legend and schedule text)	0	V	V	V
62	L-ANNO-REDL	L-----REP-	Redlines	0	0.25	R/1	R/3
63	L-ANNO-REVS	L-----RVP-	Revisions	0	0.50	C/4	C/7
NA	L-ANNO-REFR	L-----RFP-	Referenced model files (AutoCAD users only, see Chapter 4)	NA	NA	NA	NA

Note: V = Varies, NA = Not Applicable

Discipline: Structural

Level #	Level/Layer Naming		Level/Layer Description	Graphics			
	AIA Format	ISO Format		Line Style	Line Width (mm)	AutoCAD Line Color/#	MicroStation Line Color/#
General Information							
1	S-ANNO-DIMS	S-----DIP-	Sheet-specific dimensions (includes witness/extension lines, dimension terminators, dimension text)	0	V	V	V
2	S-ANNO-KEYN	S-----KEP-	Sheet-specific reference keynotes with associated leaders	0	V	V	V
3	S-ANNO-LEGN	S-----LEP-	Legends and schedules	0	V	V	V
4	S-ANNO-PATT	S-----PAP-	Sheet-specific patterning and hatching (e.g., keyplan patterning)	0	0.18	Gr/8	Gr/9
5	S-ANNO-NOTE	S-----NOP-	Sheet-specific notes and general remarks	0	0.35	Y/2	Y/4
6	S-ANNO-SYMB	S-----SYP-	Sheet-specific symbols (e.g., scales, north arrow, section cuts, detail bubbles, etc.)	V	0.35	M/6	M/5
7	S-ANNO-TEXT	S-----TEP-	Sheet-specific text and callouts with associated leaders (e.g., title block text, legend and schedule text)	0	V	V	V
62	S-ANNO-REDL	S-----REP-	Redlines	0	0.25	R/1	R/3
63	S-ANNO-REVS	S-----RVP-	Revisions	0	0.50	C/4	C/7
NA	S-ANNO-REFR	S-----RFP-	Referenced model files (AutoCAD users only, see Chapter 4)	NA	NA	NA	NA

Note: V = Varies, NA = Not Applicable

Discipline: Architectural

Level #	Level/Layer Naming		Level/Layer Description	Graphics			
	AIA Format	ISO Format		Line Style	Line Width (mm)	AutoCAD Line Color/#	MicroStation Line Color/#
General Information							
1	A-ANNO-DIMS	A-----DIP-	Sheet-specific dimensions (includes witness/extension lines, dimension terminators, dimension text)	0	V	V	V
2	A-ANNO-KEYN	A-----KEP-	Sheet-specific reference keynotes with associated leaders	0	V	V	V
3	A-ANNO-LEGN	A-----LEP-	Legends and schedules	0	V	V	V
4	A-ANNO-PATT	A-----PAP-	Sheet-specific patterning and hatching (e.g., keyplan patterning)	0	0.18	Gr/8	Gr/9
5	A-ANNO-NOTE	A-----NOP-	Sheet-specific notes and general remarks	0	0.35	Y/2	Y/4
6	A-ANNO-SYMB	A-----SYP-	Sheet-specific symbols (e.g., scales, north arrow, section cuts, detail bubbles, etc.)	V	0.35	M/6	M/5
7	A-ANNO-TEXT	A-----TEP-	Sheet-specific text and callouts with associated leaders (e.g., title block text, legend and schedule text)	0	V	V	V
62	A-ANNO-REDL	A-----REP-	Redlines	0	0.25	R/1	R/3
63	A-ANNO-REVS	A-----RVP-	Revisions	0	0.50	C/4	C/7
NA	A-ANNO-REFR	A-----RFP-	Referenced model files (AutoCAD users only, see Chapter 4)	NA	NA	NA	NA

Note: V = Varies, NA = Not Applicable

Discipline: Interiors

Level #	Level/Layer Naming		Level/Layer Description	Graphics			
	AIA Format	ISO Format		Line Style	Line Width (mm)	AutoCAD Line Color/#	MicroStation Line Color/#
General Information							
1	I-ANNO-DIMS	I----DIP-	Sheet-specific dimensions (includes witness/extension lines, dimension terminators, dimension text)	0	V	V	V
2	I-ANNO-KEYN	I-----KEP-	Sheet-specific reference keynotes with associated leaders	0	V	V	V
3	I-ANNO-LEGN	I----LEP-	Legends and schedules	0	V	V	V
4	I-ANNO-PATT	I----PAP-	Sheet-specific patterning and hatching (e.g., keyplan patterning)	0	0.18	Gr/8	Gr/9
5	I-ANNO-NOTE	I-----NOP-	Sheet-specific notes and general remarks	0	0.35	Y/2	Y/4
6	I-ANNO-SYMB	I----SYP-	Sheet-specific symbols (e.g., scales, north arrow, section cuts, detail bubbles, etc.)	V	0.35	M/6	M/5
7	I-ANNO-TEXT	I-----TEP-	Sheet-specific text and callouts with associated leaders (e.g., title block text, legend and schedule text)	0	V	V	V
62	I-ANNO-REDL	I-----REP-	Redlines	0	0.25	R/1	R/3
63	I-ANNO-REVS	I-----RVP-	Revisions	0	0.50	C/4	C/7
NA	I-ANNO-REFR	I-----RFP-	Referenced model files (AutoCAD users only, see Chapter 4)	NA	NA	NA	NA

Note: V = Varies, NA = Not Applicable

Discipline: Fire Protection

Level #	Level/Layer Naming		Level/Layer Description	Graphics			
	AIA Format	ISO Format		Line Style	Line Width (mm)	AutoCAD Line Color/#	MicroStation Line Color/#
General Information							
1	F-ANNO-DIMS	F-----DIP-	Sheet-specific dimensions (includes witness/extension lines, dimension terminators, dimension text)	0	V	V	V
2	F-ANNO-KEYN	F-----KEP-	Sheet-specific reference keynotes with associated leaders	0	V	V	V
3	F-ANNO-LEGN	F-----LEP-	Legends and schedules	0	V	V	V
4	F-ANNO-PATT	F-----PAP-	Sheet-specific patterning and hatching (e.g., keyplan patterning)	0	0.18	Gr/8	Gr/9
5	F-ANNO-NOTE	F-----NOP-	Sheet-specific notes and general remarks	0	0.35	Y/2	Y/4
6	F-ANNO-SYMB	F-----SYP-	Sheet-specific symbols (e.g., scales, north arrow, section cuts, detail bubbles, etc.)	V	0.35	M/6	M/5
7	F-ANNO-TEXT	F-----TEP-	Sheet-specific text and callouts with associated leaders (e.g., title block text, legend and schedule text)	0	V	V	V
62	F-ANNO-REDL	F-----REP-	Redlines	0	0.25	R/1	R/3
63	F-ANNO-REVS	F-----RVP-	Revisions	0	0.50	C/4	C/7
NA	F-ANNO-REFR	F-----RFP-	Referenced model files (AutoCAD users only, see Chapter 4)	NA	NA	NA	NA

Note: V = Varies, NA = Not Applicable

Discipline: Plumbing

Level #	Level/Layer Naming		Level/Layer Description	Graphics			
	AIA Format	ISO Format		Line Style	Line Width (mm)	AutoCAD Line Color/#	MicroStation Line Color/#
General Information							
1	P-ANNO-DIMS	P-----DIP-	Sheet-specific dimensions (includes witness/extension lines, dimension terminators, dimension text)	0	V	V	V
2	P-ANNO-KEYN	P-----KEP-	Sheet-specific reference keynotes with associated leaders	0	V	V	V
3	P-ANNO-LEGN	P-----LEP-	Legends and schedules	0	V	V	V
4	P-ANNO-PATT	P-----PAP-	Sheet-specific patterning and hatching (e.g., keyplan patterning)	0	0.18	Gr/8	Gr/9
5	P-ANNO-NOTE	P-----NOP-	Sheet-specific notes and general remarks	0	0.35	Y/2	Y/4
6	P-ANNO-SYMB	P-----SYP-	Sheet-specific symbols (e.g., scales, north arrow, section cuts, detail bubbles, etc.)	V	0.35	M/6	M/5
7	P-ANNO-TEXT	P-----TEP-	Sheet-specific text and callouts with associated leaders (e.g., title block text, legend and schedule text)	0	V	V	V
62	P-ANNO-REDL	P-----REP-	Redlines	0	0.25	R/1	R/3
63	P-ANNO-REVS	P-----RVP-	Revisions	0	0.50	C/4	C/7
NA	P-ANNO-REFR	P-----RFP-	Referenced model files (AutoCAD users only, see Chapter 4)	NA	NA	NA	NA

Note: V = Varies, NA = Not Applicable

Discipline: Mechanical

Level #	Level/Layer Naming		Level/Layer Description	Graphics			
	AIA Format	ISO Format		Line Style	Line Width (mm)	AutoCAD Line Color/#	MicroStation Line Color/#
General Information							
1	M-ANNO-DIMS	M-----DIP-	Sheet-specific dimensions (includes witness/extension lines, dimension terminators, dimension text)	0	V	V	V
2	M-ANNO-KEYN	M-----KEP-	Sheet-specific reference keynotes with associated leaders	0	V	V	V
3	M-ANNO-LEGN	M-----LEP-	Legends and schedules	0	V	V	V
4	M-ANNO-PATT	M-----PAP-	Sheet-specific patterning and hatching (e.g., keyplan patterning)	0	0.18	Gr/8	Gr/9
5	M-ANNO-NOTE	M-----NOP-	Sheet-specific notes and general remarks	0	0.35	Y/2	Y/4
6	M-ANNO-SYMB	M-----SYP-	Sheet-specific symbols (e.g., scales, north arrow, section cuts, detail bubbles, etc.)	V	0.35	M/6	M/5
7	M-ANNO-TEXT	M-----TEP-	Sheet-specific text and callouts with associated leaders (e.g., title block text, legend and schedule text)	0	V	V	V
62	M-ANNO-REDL	M-----REP-	Redlines	0	0.25	R/1	R/3
63	M-ANNO-REVS	M-----RVP-	Revisions	0	0.50	C/4	C/7
NA	M-ANNO-REFR	M-----RFP-	Referenced model files (AutoCAD users only, see Chapter 4)	NA	NA	NA	NA

Note: V = Varies, NA = Not Applicable

Discipline: Electrical

Level #	Level/Layer Naming		Level/Layer Description	Graphics			
	AIA Format	ISO Format		Line Style	Line Width (mm)	AutoCAD Line Color/#	MicroStation Line Color/#
General Information							
1	E-ANNO-DIMS	E-----DIP-	Sheet-specific dimensions (includes witness/extension lines, dimension terminators, dimension text)	0	V	V	V
2	E-ANNO-KEYN	E-----KEP-	Sheet-specific reference keynotes with associated leaders	0	V	V	V
3	E-ANNO-LEGN	E-----LEP-	Legends and schedules	0	V	V	V
4	E-ANNO-PATT	E-----PAP-	Sheet-specific patterning and hatching (e.g., keyplan patterning)	0	0.18	Gr/8	Gr/9
5	E-ANNO-NOTE	E-----NOP-	Sheet-specific notes and general remarks	0	0.35	Y/2	Y/4
6	E-ANNO-SYMB	E-----SYP-	Sheet-specific symbols (e.g., scales, north arrow, section cuts, detail bubbles, etc.)	V	0.35	M/6	M/5
7	E-ANNO-TEXT	E-----TEP-	Sheet-specific text and callouts with associated leaders (e.g., title block text, legend and schedule text)	0	V	V	V
62	E-ANNO-REDL	E-----REP-	Redlines	0	0.25	R/1	R/3
63	E-ANNO-REVS	E-----RVP-	Revisions	0	0.50	C/4	C/7
NA	E-ANNO-REFR	E-----RFP-	Referenced model files (AutoCAD users only, see Chapter 4)	NA	NA	NA	NA

Note: V = Varies, NA = Not Applicable

Discipline: Telecommunications

Level #	Level/Layer Naming		Level/Layer Description	Graphics			
	AIA Format	ISO Format		Line Style	Line Width (mm)	AutoCAD Line Color/#	MicroStation Line Color/#
General Information							
1	T-ANNO-DIMS	T-----DIP-	Sheet-specific dimensions (includes witness/extension lines, dimension terminators, dimension text)	0	V	V	V
2	T-ANNO-KEYN	T-----KEP-	Sheet-specific reference keynotes with associated leaders	0	V	V	V
3	T-ANNO-LEGN	T-----LEP-	Legends and schedules	0	V	V	V
4	T-ANNO-PATT	T-----PAP-	Sheet-specific patterning and hatching (e.g., keyplan patterning)	0	0.18	Gr/8	Gr/9
5	T-ANNO-NOTE	T-----NOP-	Sheet-specific notes and general remarks	0	0.35	Y/2	Y/4
6	T-ANNO-SYMB	T-----SYP-	Sheet-specific symbols (e.g., scales, north arrow, section cuts, detail bubbles, etc.)	V	0.35	M/6	M/5
7	T-ANNO-TEXT	T-----TEP-	Sheet-specific text and callouts with associated leaders (e.g., title block text, legend and schedule text)	0	V	V	V
62	T-ANNO-REDL	T-----REP-	Redlines	0	0.25	R/1	R/3
63	T-ANNO-REVS	T-----RVP-	Revisions	0	0.50	C/4	C/7
NA	T-ANNO-REFR	T-----RFP-	Referenced model files (AutoCAD users only, see Chapter 4)	NA	NA	NA	NA

Note: V = Varies, NA = Not Applicable

Appendix C

Color Comparison

For more information on Screened Colors, see the section "Screening" in Chapter 3 "Graphic Concepts."

**Appendix C
Color Comparison**

AutoCAD Color No.	MicroStation Color No.	Screened Color
1	3	
2	4	
3	2	
4	7	
5	1	
6	5	
7	0	
8	9	
9	14	
10	10	Yes
11	19	Yes
12	27	Yes
13	35	Yes
14	43	Yes
15	51	Yes
16	59	Yes
17	67	
18	75	
19	83	Yes
20	6	
21	30	
22	22	
23	46	
24	38	
25	62	
26	54	
27	78	
28	70	
29	94	
30	86	
31	110	
32	102	
33	126	
34	118	
35	142	
36	134	
37	158	
38	150	
39	174	
40	166	
41	190	
42	182	
43	206	
44	198	
45	222	
46	214	

**Appendix C
Color Comparison**

AutoCAD Color No.	MicroStation Color No.	Screened Color
47	238	
48	230	
49	251	
50	20	Yes
51	28	Yes
52	36	Yes
53	44	Yes
54	52	Yes
55	60	Yes
56	68	Yes
57	76	
58	84	
59	92	Yes
60	100	
61	108	
62	116	
63	124	
64	132	
65	140	
66	148	
67	156	
68	164	
69	172	
70	180	
71	188	
72	196	
73	204	
74	212	
75	220	
76	228	
77	236	
78	244	
79	252	
80	11	
81	26	
82	18	
83	42	
84	34	
85	58	
86	50	
87	74	
88	66	
89	90	
90	82	Yes
91	106	Yes
92	98	Yes

**Appendix C
Color Comparison**

AutoCAD Color No.	MicroStation Color No.	Screened Color
93	122	Yes
94	114	Yes
95	138	Yes
96	130	Yes
97	154	
98	146	
99	170	Yes
100	162	
101	186	
102	178	
103	202	
104	194	
105	218	
106	210	
107	234	
108	226	
109	250	
110	242	
111	246	
112	247	
113	16	
114	32	
115	48	
116	64	
117	80	
118	96	
119	112	
120	12	
121	15	
122	23	
123	31	
124	39	
125	47	
126	55	
127	63	
128	71	
129	79	
130	87	Yes
131	95	Yes
132	103	Yes
133	111	Yes
134	119	Yes
135	127	Yes
136	135	Yes
137	143	
138	151	

**Appendix C
Color Comparison**

AutoCAD Color No.	MicroStation Color No.	Screened Color
139	159	Yes
140	167	
141	175	
142	183	
143	191	
144	199	
145	207	
146	215	
147	223	
148	231	
149	239	
150	40	
151	72	
152	88	
153	104	
154	136	
155	152	
156	184	
157	216	
158	232	
159	248	
160	17	
161	25	
162	33	
163	41	
164	49	
165	57	
166	65	
167	73	
168	81	
169	89	
170	97	Yes
171	105	Yes
172	113	Yes
173	121	Yes
174	129	Yes
175	137	Yes
176	145	Yes
177	153	
178	161	
179	169	Yes
180	177	
181	185	
182	193	
183	201	
184	209	

**Appendix C
Color Comparison**

AutoCAD Color No.	MicroStation Color No.	Screened Color
185	217	
186	225	
187	233	
188	241	
189	249	
190	245	
191	128	
192	144	
193	160	
194	176	
195	192	
196	208	
197	224	
198	240	
199	254	
200	13	
201	29	
202	21	
203	45	
204	37	
205	61	
206	53	
207	77	
208	69	
209	93	
210	85	Yes
211	109	Yes
212	101	Yes
213	125	Yes
214	117	Yes
215	141	Yes
216	133	Yes
217	157	
218	149	
219	173	Yes
220	165	
221	189	
222	181	
223	205	
224	197	
225	221	
226	213	
227	237	
228	229	
229	253	
230	91	

**Appendix C
Color Comparison**

AutoCAD Color No.	MicroStation Color No.	Screened Color
231	99	
232	107	
233	115	
234	123	
235	131	
236	139	
237	147	
238	155	
239	163	
240	171	
241	179	
242	187	
243	195	
244	203	
245	211	
246	219	
247	227	
248	235	
249	243	
250	8	Yes
251	200	Yes
252	168	Yes
253	120	Yes
254	56	Yes
255	24	Yes

REPORT DOCUMENTATION PAGE

Form Approved
OMB No. 0704-0188

Public reporting burden for this collection of information is estimated to average 1 hour per response, including the time for reviewing instructions, searching existing data sources, gathering and maintaining the data needed, and completing and reviewing this collection of information. Send comments regarding this burden estimate or any other aspect of this collection of information, including suggestions for reducing this burden to Department of Defense, Washington Headquarters Services, Directorate for Information Operations and Reports (0704-0188), 1215 Jefferson Davis Highway, Suite 1204, Arlington, VA 22202-4302. Respondents should be aware that notwithstanding any other provision of law, no person shall be subject to any penalty for failing to comply with a collection of information if it does not display a currently valid OMB control number. **PLEASE DO NOT RETURN YOUR FORM TO THE ABOVE ADDRESS.**

1. REPORT DATE (DD-MM-YYYY) September 2001		2. REPORT TYPE Final report		3. DATES COVERED (From - To)	
4. TITLE AND SUBTITLE A/E/C CADD Standard, Release 2.0; Main Text and Appendices A, B, and C				5a. CONTRACT NUMBER	
				5b. GRANT NUMBER	
				5c. PROGRAM ELEMENT NUMBER	
6. AUTHOR(S) The CADD/GIS Technology Center				5d. PROJECT NUMBER	
				5e. TASK NUMBER	
				5f. WORK UNIT NUMBER	
7. PERFORMING ORGANIZATION NAME(S) AND ADDRESS(ES) U.S. Army Engineer Research and Development Center 3909 Halls Ferry Road Vicksburg, MS 39180-6199				8. PERFORMING ORGANIZATION REPORT NUMBER ERDC/ITL TR-01-6	
9. SPONSORING / MONITORING AGENCY NAME(S) AND ADDRESS(ES)				10. SPONSOR/MONITOR'S ACRONYM(S)	
				11. SPONSOR/MONITOR'S REPORT NUMBER(S)	
12. DISTRIBUTION / AVAILABILITY STATEMENT Approved for public release; distribution is unlimited.					
13. SUPPLEMENTARY NOTES Appendix D is bound separately.					
14. ABSTRACT The "A/E/C CADD Standard Manual" has been developed by the CADD/GIS Technology Center (CGTC) to reduce redundant CADD standardization efforts within the Army, Navy, and Air Force. The manual is part of an initiative to consolidate existing CADD drafting standards and to develop data standards that address the entire life-cycle of facilities within the Department of Defense Tri-Service. The CADD drafting standards addressed in the "A/E/C CADD Standard Manual" include presentation graphics, level/layer assignments, metric/English scales, electronic file naming, and standard symbology. As the manual evolves, it will also include nongraphic database standards that address issues such as cost engineering and specification generation. The CGTC's primary goal is to develop a CADD standard that is generic enough to operate under various CADD software packages (such as Intergraph's MicroStation and Autodesk's AutoCAD) and incorporate existing industry standards when possible.					
15. SUBJECT TERMS A/E/C CADD		CADD standards Drafting standards			
16. SECURITY CLASSIFICATION OF:			17. LIMITATION OF ABSTRACT	18. NUMBER OF PAGES 176	19a. NAME OF RESPONSIBLE PERSON
a. REPORT UNCLASSIFIED	b. ABSTRACT UNCLASSIFIED	c. THIS PAGE UNCLASSIFIED			19b. TELEPHONE NUMBER (include area code)

